



香港特別行政區政府知識產權署商標註冊處
Trade Marks Registry, Intellectual Property Department
The Government of the Hong Kong Special Administrative Region

接納註冊 (全文本)

商標註冊處處長已根據《商標條例》(第 559 章)第 42 條，接納下列商標的註冊申請。現根據《商標條例》第 43 條及《商標規則》(第 559 章附屬法例)第 15 條，公布申請的詳情。

根據《商標條例》第 44 條及《商標規則》第 16 條，任何人擬就下列商標的註冊提出反對，須在本公告公布日期起計的三個月內，採用表格第 T6 號提交反對通知。(例如，若果公布日期為 2003 年 4 月 4 日，則該三個月的最後一日為 2003 年 7 月 3 日。)反對通知須載有反對理由的陳述及《商標規則》第 16(2)條所提述的事宜。反對人須在提交反對通知的同時，將該通知的副本送交有關申請人。

有關商標註冊處處長根據商標條例(第 43 章)第 13 條/商標條例(第 559 章)附表 5 第 10 條所接納的註冊申請，請到 <http://www.info.gov.hk/pd/egazette/> 檢視電子憲報。

ACCEPTANCE FOR REGISTRATION (FULL VERSION)

The Registrar of Trade Marks has accepted the following trade marks for registration under section 42 of the Trade Marks Ordinance (Cap. 559). Under section 43 of the Trade Marks Ordinance and rule 15 of the Trade Marks Rules (Cap. 559 sub. leg.), the particulars of the applications are published.

Under section 44 of the Trade Marks Ordinance and rule 16 of the Trade Marks Rules, any person who wishes to oppose the registration of any of these marks shall, within the 3-month period beginning on the date of this publication, file a notice of opposition on Form T6. (For example, if the publication date is 4 April 2003, the last day of the 3-month period is 3 July 2003.) The notice of opposition shall include a statement of the grounds of opposition and the matters referred to in rule 16(2). The opponent shall, at the same time as he files the notice of opposition, send a copy of it to the applicant of the application in question.

For applications for registration accepted by the Registrar of Trade Marks under section 13 of the Trade Marks Ordinance (Cap. 43)/section 10 of Schedule 5 to the Trade Marks Ordinance (Cap. 559), please view e-gazette at <http://www.info.gov.hk/pd/egazette/>.

類別 Class 28

[210] 商標申請編號： 300076086

Application No.:

[540] 商標：

Mark:

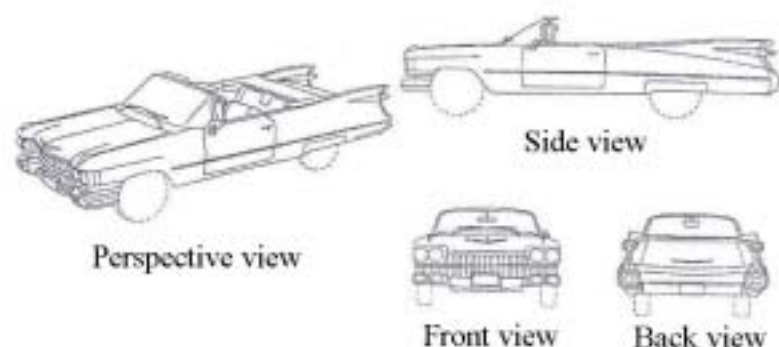

[550] 商標種類： Ordinary

Mark Type:

一系列商標： No

Series Mark:

[571] 商標描述： The mark consists of a 3-dimensional shape.

Mark Description: The applicant claims the shape of a vehicle body as a trade mark.

[730] 註冊申請人的 GENERAL MOTORS CORPORATION

姓名/名稱、地址： 300 RENAISSANCE CENTER, CITY OF DETROIT, STATE OF MICHIGAN

[740/750] Applicant(s)' Name,Address: 48265-3000, UNITED STATES OF AMERICA.
 註冊申請人的送達地址: ROBIN BRIDGE & JOHN LIU
 Applicant's Address for Service: 22/F.,LANE CRAWFORD HSE., 70 QUEEN'S ROAD C., HONG KONG.
 [511] 類別編號: 28
 Class(es) No(s):
 [511] 貨品/服務說明: Class 28:
 Specification: playing cards, board games, computer games; balloons.
 [526] 卸棄: N/A
 Disclaimer:
 [529] 限制: N/A
 Limitation:
 [527] 條件: N/A
 Condition:
 其他: N/A
 Others
 [220] 提交日期: 09-09-2003
 Date of Filing:
 [320] 聲稱具有優先權的日期: N/A
 Dates of Priority Claimed:
 [310] 優先權申請編號: N/A
 Priority Application No.:
 [330] 優先權申請的國家、地區、地方: N/A
 Country, Territory, Area of Priority Applications:

[210] 商標申請編號: 300076112AB
 Application No.:
 [540] 商標:
 Mark:

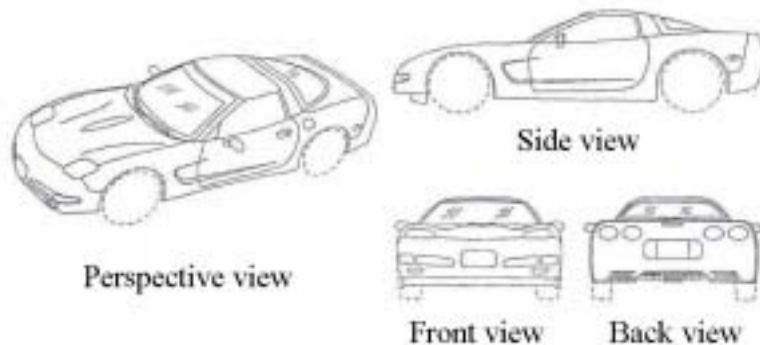

[550] 商標種類: Ordinary
 Mark Type:
 一系列商標: No
 Series Mark:
 [571] 商標描述: The mark consists of a 3-dimensional shape.
 Mark Description: The applicant claims the shape of a vehicle body as a trade mark.
 [730] 註冊申請人的姓名/名稱、地址: GENERAL MOTORS CORPORATION
 Applicant(s)' Name,Address: 300 RENAISSANCE CENTER, CITY OF DETROIT, STATE OF MICHIGAN
 48265-3000, UNITED STATES OF AMERICA.
 [740/750] 註冊申請人的送達地址: ROBIN BRIDGE & JOHN LIU
 Applicant's Address for Service: 22/F.,LANE CRAWFORD HSE., 70 QUEEN'S ROAD C., HONG KONG.
 [511] 類別編號: 28
 Class(es) No(s):

[511] 貨品／服務說明：
Specification: Class 28:
playing cards, board games, computer games; balloons.

[526] 卸棄：
Disclaimer: N/A

[529] 限制：
Limitation: N/A

[527] 條件：
Condition: N/A

其他：
Others: N/A

[220] 提交日期：
Date of Filing: 09-09-2003

[320] 聲稱具有優先權的日期：
Dates of Priority Claimed: N/A

[310] 優先權申請編號：
Priority Application No.: N/A

[330] 優先權申請的國家、地區、地
方：
Country, Territory, Area of Priority
Applications: N/A

[210] 商標申請編號：
Application No.: 300076149

[540] 商標：
Mark:

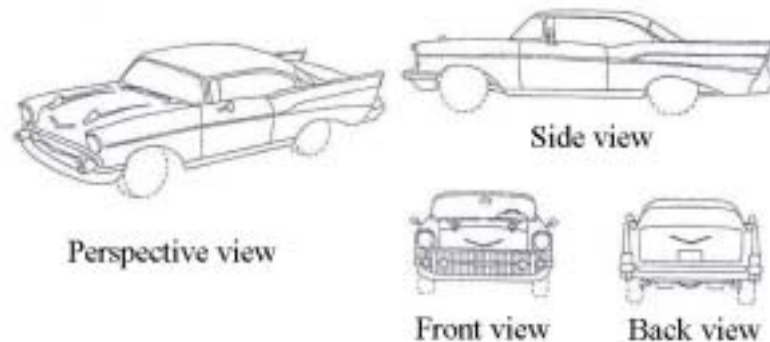

[550] 商標種類：
Mark Type: Ordinary

一系列商標：
Series Mark: No

[571] 商標描述：
Mark Description: The mark consists of a 3-dimensional shape.
The applicant claims the shape of a vehicle body as a trade mark.

[730] 註冊申請人的
姓名／名稱、地址：
Applicant(s)' Name, Address: GENERAL MOTORS CORPORATION
300 RENAISSANCE CENTER, CITY OF DETROIT, STATE OF MICHIGAN
48265-3000, UNITED STATES OF AMERICA.

[740/
750] 註冊申請人的送達地址：
Applicant's Address for Service: ROBIN BRIDGE & JOHN LIU
22/F.,LANE CRAWFORD HSE., 70 QUEEN'S ROAD C., HONG KONG.

[511] 類別編號：
Class(es) No(s): 28

[511] 貨品／服務說明：
Specification: Class 28:
playing cards, board games, computer games; balloons.

[526] 卸棄：
Disclaimer: N/A

[529] 限制：
Limitation: N/A

[527] **Limitation:**
 條件: N/A
Condition:
 其他: N/A
Others
 [220] 提交日期: 09-09-2003
Date of Filing:
 [320] 聲稱具有優先權的日期: N/A
Dates of Priority Claimed:
 [310] 優先權申請編號: N/A
Priority Application No.:
 [330] 優先權申請的國家、地區、地方: N/A
Country, Territory, Area of Priority Applications:

[210] 商標申請編號: 300076176
Application No.:
 [540] 商標:
Mark:

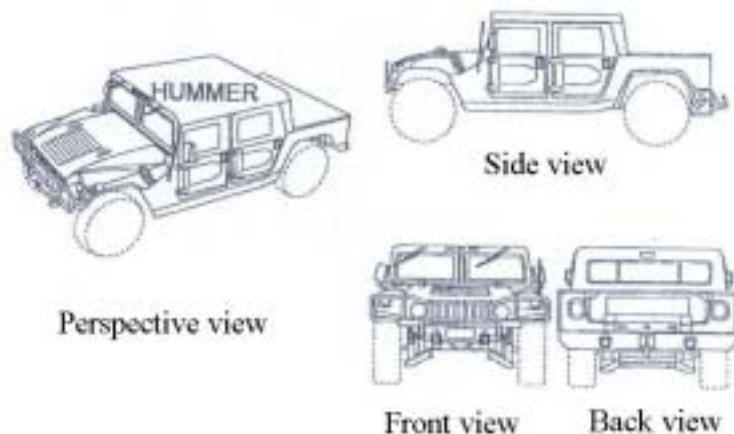

[550] 商標種類: Ordinary
Mark Type:
 一系列商標: No
Series Mark:
 [571] 商標描述: The mark consists of a 3-dimensional shape with the word appearing on it.
Mark Description: The applicant claims the shape of a vehicle body as a trade mark.
 [730] 註冊申請人的姓名/名稱、地址: GENERAL MOTORS CORPORATION
Applicant(s)' Name,Address: 300 RENAISSANCE CENTER, CITY OF DETROIT, STATE OF MICHIGAN
 48265-3000, UNITED STATES OF AMERICA.
 [740/750] 註冊申請人的送達地址: ROBIN BRIDGE & JOHN LIU
Applicant's Address for Service: 22/F.,LANE CRAWFORD HSE., 70 QUEEN'S ROAD C., HONG KONG.
 [511] 類別編號: 28
Class(es) No(s).:
 [511] 貨品/服務說明: Class 28:
Specification: toys, toy vehicles, toy cars, battery-operated remote and radio controlled toy vehicles, friction-powered toy vehicles.
 [526] 卸棄: N/A
Disclaimer:
 [529] 限制: N/A
Limitation:
 [527] 條件: N/A

Condition:
 其他: N/A
 Others
 [220] 提交日期: 09-09-2003
 Date of Filing:
 [320] 聲稱具有優先權的日期: N/A
 Dates of Priority Claimed:
 [310] 優先權申請編號: N/A
 Priority Application No.:
 [330] 優先權申請的國家、地區、地方: N/A
 Country, Territory, Area of Priority Applications:

[210] 商標申請編號: 300076194AB
 Application No.:
 [540] 商標:
 Mark:

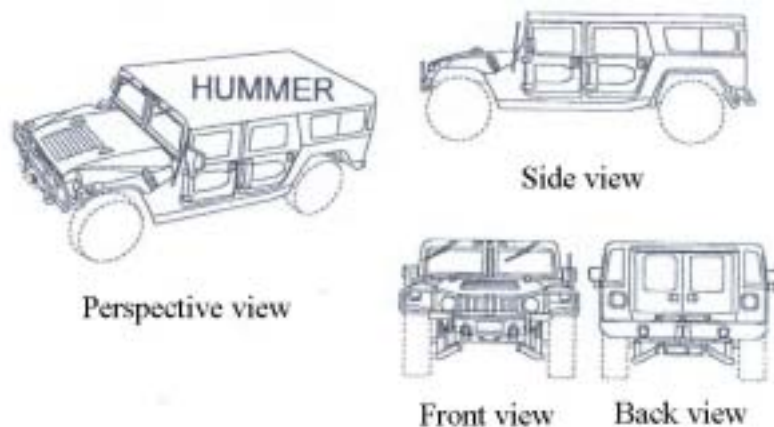

[550] 商標種類: Ordinary
 Mark Type:
 一系列商標: No
 Series Mark:
 [571] 商標描述: The mark consists of a 3-dimensional shape with the word appearing on it.
 Mark Description: The applicant claims the shape of a vehicle body as a trade mark.
 [730] 註冊申請人的姓名/名稱、地址: GENERAL MOTORS CORPORATION
 Applicant(s) Name,Address: 300 RENAISSANCE CENTER, CITY OF DETROIT, STATE OF MICHIGAN
 48265-3000, UNITED STATES OF AMERICA.
 [740/750] 註冊申請人的送達地址: ROBIN BRIDGE & JOHN LIU
 Applicant's Address for Service: 22/F.,LANE CRAWFORD HSE., 70 QUEEN'S ROAD C., HONG KONG.
 [511] 類別編號: 28
 Class(es) No(s):
 [511] 貨品/服務說明: Class 28:
 Specification: toys, toy vehicles, toy cars, battery-operated remote and radio controlled toy vehicles, friction-powered toy vehicles.
 [526] 卸棄: N/A
 Disclaimer:
 [529] 限制: N/A
 Limitation:
 [527] 條件: N/A
 Condition:
 其他: N/A
 Others

[220] 提交日期 : 09-09-2003
 Date of Filing:
 [320] 聲稱具有優先權的日期 : N/A
 Dates of Priority Claimed:
 [310] 優先權申請編號 : N/A
 Priority Application No.:
 [330] 優先權申請的國家、地區、地方 : N/A
 Country, Territory, Area of Priority Applications:

[210] 商標申請編號 : 300076211AB
 Application No.:
 [540] 商標 :
 Mark:

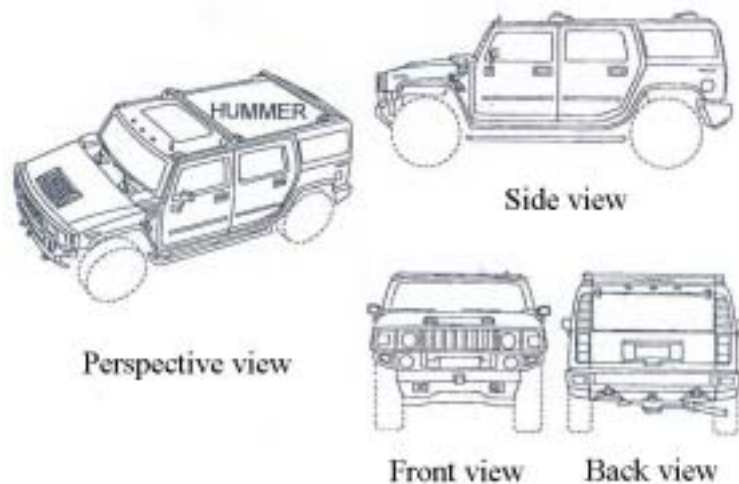

[550] 商標種類 : Ordinary
 Mark Type:
 一系列商標 : No
 Series Mark:
 [571] 商標描述 : The mark consists of a 3-dimensional shape with the word appearing on it.
 Mark Description: The applicant claims the shape of a vehicle body as a trade mark.
 [730] 註冊申請人的姓名/名稱、地址 : GENERAL MOTORS CORPORATION
 Applicant(s) Name,Address: 300 RENAISSANCE CENTER, CITY OF DETROIT, STATE OF MICHIGAN
 48265-3000, UNITED STATES OF AMERICA.
 [740/750] 註冊申請人的送達地址 : ROBIN BRIDGE & JOHN LIU
 Applicant's Address for Service: 22/F.,LANE CRAWFORD HSE., 70 QUEEN'S ROAD C., HONG KONG.
 [511] 類別編號 : 28
 Class(es) No(s).:
 [511] 貨品/服務說明 : Class 28:
 Specification: toys, toy vehicles, toy cars, battery-operated remote and radio controlled toy vehicles, friction-powered toy vehicles.
 [526] 卸棄 : N/A
 Disclaimer:
 [529] 限制 : N/A
 Limitation:
 [527] 條件 : N/A
 Condition:
 其他 : N/A
 Others
 [220] 提交日期 : 09-09-2003

[320] Date of Filing:
聲稱具有優先權的日期 : N/A

[310] Dates of Priority Claimed:
優先權申請編號 : N/A

[330] Priority Application No.:
優先權申請的國家、地區、地方 : N/A
Country, Territory, Area of Priority Applications:

[210] 商標申請編號 : 300076239
Application No.:

[540] 商標 :
Mark:

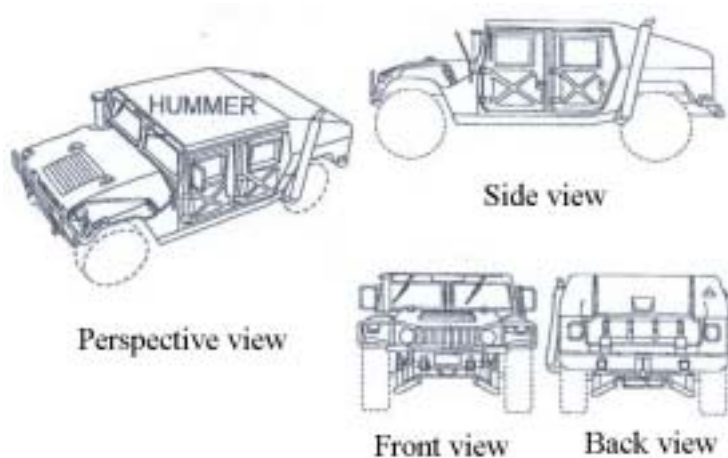

[550] 商標種類 : Ordinary

Mark Type: No
一系列商標 :

Series Mark:

[571] 商標描述 : The mark consists of a 3-dimensional shape with the word appearing on it.
Mark Description: The applicant claims the shape of a vehicle body as a trade mark.

[730] 註冊申請人的姓名/名稱、地址 : GENERAL MOTORS CORPORATION
Applicant(s) Name,Address: 300 RENAISSANCE CENTER, CITY OF DETROIT, STATE OF MICHIGAN 48265-3000, UNITED STATES OF AMERICA.

[740/750] 註冊申請人的送達地址 : ROBIN BRIDGE & JOHN LIU
Applicant's Address for Service: 22/F.,LANE CRAWFORD HSE., 70 QUEEN'S ROAD C., HONG KONG.

[511] 類別編號 : 28

Class(es) No(s):

[511] 貨品/服務說明 : Class 28:
Specification: toys, toy vehicles, toy cars, battery-operated remote and radio controlled toy vehicles, friction-powered toy vehicles.

[526] 卸棄 : N/A

Disclaimer:

[529] 限制 : N/A

Limitation:

[527] 條件 : N/A

Condition:

其他 : N/A

Others

[220] 提交日期 : 09-09-2003

Date of Filing:

[320] 聲稱具有優先權的日期 : N/A

Dates of Priority Claimed:
 [310] 優先權申請編號: N/A
 Priority Application No.:
 [330] 優先權申請的國家、地區、地方:
 Country, Territory, Area of Priority Applications: N/A

[210] 商標申請編號: 300082142AB
 Application No.:

[540] 商標:
 Mark:

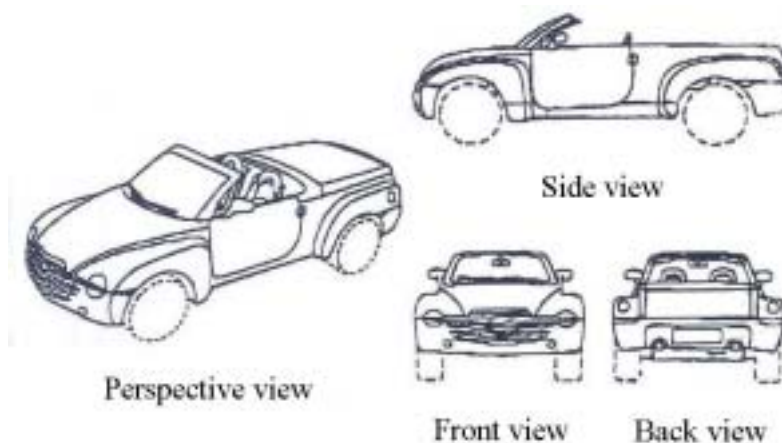

[550] 商標種類: Ordinary

Mark Type:
 一系列商標: No

Series Mark:

[571] 商標描述: The mark consists of a 3-dimensional shape.
 Mark Description: The applicant claims the shape of a vehicle body as a trade mark.

[730] 註冊申請人的姓名/名稱、地址: GENERAL MOTORS CORPORATION
 300 RENAISSANCE CENTER, CITY OF DETROIT, STATE OF MICHIGAN
 48265-3000, UNITED STATES OF AMERICA.

[740/750] 註冊申請人的送達地址: ROBIN BRIDGE & JOHN LIU
 Applicant's Address for Service: 22/F.,LANE CRAWFORD HSE., 70 QUEEN'S ROAD C., HONG KONG.

[511] 類別編號: 28

Class(es) No(s):

[511] 貨品/服務說明: Class 28:
 Specification: playing cards, board games, computer games; balloons.

[526] 卸棄: N/A

Disclaimer:

[529] 限制: N/A

Limitation:

[527] 條件: N/A

Condition:

其他: N/A

Others

[220] 提交日期: 22-09-2003



Date of Filing:

[320] 聲稱具有優先權的日期: N/A

Dates of Priority Claimed:

[310] 優先權申請編號: N/A

Priority Application No.:

[330]	優先權申請的國家、地區、地方： Country, Territory, Area of Priority Applications:	N/A
<hr/>		
[210]	商標申請編號： Application No.:	300236420
[540]	商標： Mark:	A  B 
[550]	商標種類： Mark Type:	Ordinary
	一系列商標： Series Mark:	Yes
[571]	商標描述： Mark Description:	N/A
[730]	註冊申請人的姓名／名稱、地址： Applicant(s) Name,Address:	KABUSHIKI KAISHA SHIMANO (SHIMANO INC.) 3-77 OIMATSU-CHO, SAKAI, OSAKA 590-8577, JAPAN.
[740/750]	註冊申請人的送達地址： Applicant's Address for Service:	LOVELLS 23RD FLOOR, CHEUNG KONG CENTER, 2 QUEEN'S ROAD CENTRAL, HONG KONG.
[511]	類別編號： Class(es) No(s):	28
[511]	貨品／服務說明： Specification:	Class 28: fishing tackle, including reels for fishing, rods for fishing, lines for fishing, line guides (for use on fishing rods), hooks for fishing, lures (artificial) for fishing, artificial baits, creels (fishing equipment), floats for fishing, fishing weights (namely, sinkers), landing nets for anglers, fishing bags, fishing gloves; fishing rod cases and fishing tackle containers, hip-guards specially made for fishing, accessories for fishing.
[526]	卸棄： Disclaimer:	N/A
[529]	限制： Limitation:	N/A
[527]	條件： Condition:	N/A
	其他： Others	N/A
[220]	提交日期： Date of Filing:	21-06-2004
[320]	聲稱具有優先權的日期： Dates of Priority Claimed:	N/A
[310]	優先權申請編號： Priority Application No.:	N/A
[330]	優先權申請的國家、地區、地方： Country, Territory, Area of Priority Applications:	N/A

[210] 商標申請編號 : 300299584

Application No.:

[540] 商標 :

Mark:



[550] 商標種類 : Ordinary

Mark Type:

一系列商標 :

No

Series Mark:

[571] 商標描述 :

N/A

Mark Description:

[730] 註冊申請人的

LI TAK LEUNG

姓名/名稱、地址 :

ROOM 8, LUK YIP LAU, HEALTHY VILLAGE, NORTH POINT, HONG KONG.

Applicant(s)' Name,Address:

[740/

LI TAK LEUNG

750] 註冊申請人的送達地址 :

ROOM 8, LUK YIP LAU, HEALTHY VILLAGE, NORTH POINT, HONG KONG.

Applicant's Address for Service:

[511] 類別編號 :

18, 20, 22, 28

Class(es) No(s).:

[511] 貨品/服務說明 :

Class 28:

Specification:

toys for pets; toys being training aids for pets training; imitation bones being

playthings for pets; imitation bones being toys for pets.

[526] 卸棄 :

N/A

Disclaimer:

[529] 限制 :

N/A

Limitation:

[527] 條件 :

N/A

Condition:

其他 :

N/A

Others

[220] 提交日期 :

12-10-2004

Date of Filing:

[320] 聲稱具有優先權的日期 :

N/A

Dates of Priority Claimed:

[310] 優先權申請編號 :

N/A

Priority Application No.:

[330] 優先權申請的國家、地區、地

N/A

方 :

Country, Territory, Area of Priority

Applications:

[210] 商標申請編號 : 300358803

Application No.:

- [540] 商標 :
Mark: **FLUSHED AWAY**
- [550] 商標種類 : Ordinary
Mark Type:
一系列商標 : No
Series Mark:
- [571] 商標描述 : N/A
Mark Description:
- [730] 註冊申請人的 DREAMWORKS ANIMATION L.L.C.
姓名/名稱、地址 : 1000 FLOWER STREET, GLENDALE, CALIFORNIA 91201, UNITED STATES.
Applicant(s) Name,Address:
- [740/ 註冊申請人的送達地址 : WILKINSON & GRIST
750] Applicant's Address for Service: 6TH FLOOR, PRINCE'S BUILDING, CHATER ROAD, HONG KONG.
- [511] 類別編號 : 9, 28
Class(es) No(s):
- [511] 貨品/服務說明 : Class 28:
Specification: Games and playthings; gymnastic and sporting articles not included in other classes; decorations for Christmas trees; action figures and accessories therefor, bathtub toys, kites, toy building blocks, board games, costume masks, hand-held unit for playing electronic games, die cast miniature toy vehicles, dolls, doll accessories, doll clothing, bean bag dolls, bendable play figures, flying discs, inflatable vinyl play figures, jigsaw puzzles, marbles, plush toys, puppets, ride-on toys, skateboards, balloons, rollerskates, toy banks, water squirting toys, stuffed toys, toy vehicles, christmas tree ornaments; pinball machines and model craft kits of toy figures; and playing cards.
- [526] 卸棄 : N/A
Disclaimer:
- [529] 限制 : N/A
Limitation:
- [527] 條件 : N/A
Condition:
- 其他 : N/A
Others
- [220] 提交日期 : 24-01-2005
Date of Filing:
- [320] 聲稱具有優先權的日期 : N/A
Dates of Priority Claimed:
- [310] 優先權申請編號 : N/A
Priority Application No.:
- [330] 優先權申請的國家、地區、地 N/A
方 :
Country, Territory, Area of Priority Applications:
-

[210] 商標申請編號 : 300358812
Application No.:

[540] 商標 :
Mark: **OVER THE HEDGE**

[550] 商標種類 : Ordinary
Mark Type:

	一系列商標：	No
	Series Mark:	
[571]	商標描述：	N/A
	Mark Description:	
[730]	註冊申請人的	DREAMWORKS ANIMATION L.L.C.
	姓名／名稱、地址：	1000 FLOWER STREET, GLENDALE, CALIFORNIA 91201, UNITED STATES.
	Applicant(s)' Name,Address:	
[740/750]	註冊申請人的送達地址：	WILKINSON & GRIST
	Applicant's Address for Service:	6TH FLOOR, PRINCE'S BUILDING, CHATER ROAD, HONG KONG.
[511]	類別編號：	9, 28
	Class(es) No(s):	
[511]	貨品／服務說明：	Class 28:
	Specification:	Games and playthings; gymnastic and sporting articles not included in other classes; decorations for Christmas trees; action figures and accessories therefor, bathtub toys, kites, toy building blocks, board games, costume masks, hand-held unit for playing electronic games, die cast miniature toy vehicles, dolls, doll accessories, doll clothing, bean bag dolls, bendable play figures, flying discs, inflatable vinyl play figures, jigsaw puzzles, marbles, plush toys, puppets, ride-on toys, skateboards, balloons, rollerskates, toy banks, water squirting toys, stuffed toys, toy vehicles, christmas tree ornaments; pinball machines and model craft kits of toy figures; and playing cards.
[526]	卸棄：	N/A
	Disclaimer:	
[529]	限制：	N/A
	Limitation:	
[527]	條件：	N/A
	Condition:	
	其他：	N/A
	Others	
[220]	提交日期：	24-01-2005
	Date of Filing:	
[320]	聲稱具有優先權的日期：	N/A
	Dates of Priority Claimed:	
[310]	優先權申請編號：	N/A
	Priority Application No.:	
[330]	優先權申請的國家、地區、地方：	N/A
	Country, Territory, Area of Priority Applications:	

[210]	商標申請編號：	300360521
	Application No.:	
[540]	商標：	HONEY B
	Mark:	
[550]	商標種類：	Ordinary
	Mark Type:	
	一系列商標：	Yes
	Series Mark:	
[571]	商標描述：	N/A
	Mark Description:	
[730]	註冊申請人的	HEROINE INTERNATIONAL LIMITED
	姓名／名稱、地址：	UNIT G, 25/F, CDW BUILDING, 388 CASTLE PEAK ROAD, TSUEN WAN, N.T., HONG KONG.
	Applicant(s)' Name,Address:	

[740/750]	註冊申請人的送達地址： Applicant's Address for Service:	IP IMPETUS CONSULTANTS LIMITED UNIT 1006, HANG SENG BUILDING, 77 DES VOEUX ROAD CENTRAL, HONG KONG.
[511]	類別編號： Class(es) No(s).:	16, 18, 24, 25, 28, 35
[511]	貨品／服務說明： Specification:	Class 28: toys; children's toys; drawing toys; electronic toys; fluffy toys; battery operated toys; inflatable toys; metal toys; model figures (toys or playthings); model toys; musical toys; paper toys; plastic toys; rubber toys; soft toys; toy masks; toy vehicles; dolls; games and playthings; gymnastic and sporting articles; decorations for Christmas; all included in Class 28.
[526]	卸棄： Disclaimer:	N/A
[529]	限制： Limitation:	N/A
[527]	條件： Condition:	N/A
	其他： Others	N/A
[220]	提交日期： Date of Filing:	26-01-2005
[320]	聲稱具有優先權的日期： Dates of Priority Claimed:	N/A
[310]	優先權申請編號： Priority Application No.:	N/A
[330]	優先權申請的國家、地區、地 方： Country, Territory, Area of Priority Applications:	N/A

[210]	商標申請編號： Application No.:	300365436
[540]	商標： Mark:	A <i>Ultimate Master</i> B <i>UltimateMaster</i>
[550]	商標種類： Mark Type:	Ordinary
	一系列商標： Series Mark:	Yes
[571]	商標描述： Mark Description:	N/A
[730]	註冊申請人的 姓名／名稱、地址： Applicant(s)' Name, Address:	PETER, MICHAEL, KAI LTD RM 1205, 12/F HARBOUR HOUSE, 39 GLOUCESTER ROAD, HONG KONG.
[740/750]	註冊申請人的送達地址： Applicant's Address for Service:	BIRD & BIRD 6/F ICBC TOWER, CITIBANK PLAZA, 3 GARDEN ROAD, HONG KONG.
[511]	類別編號： Class(es) No(s).:	9, 16, 25, 28, 41
[511]	貨品／服務說明： Specification:	Class 28: games and playthings; gymnastic and sporting articles not included in other classes; decorations for Christmas trees, playing cards.

[526]	卸棄： Disclaimer:	N/A
[529]	限制： Limitation:	N/A
[527]	條件： Condition:	N/A
	其他： Others	N/A
[220]	提交日期： Date of Filing:	02-02-2005
[320]	聲稱具有優先權的日期： Dates of Priority Claimed:	N/A
[310]	優先權申請編號： Priority Application No.:	N/A
[330]	優先權申請的國家、地區、地 方： Country, Territory, Area of Priority Applications:	N/A

[210]	商標申請編號： Application No.:	300371826
[540]	商標： Mark:	NINTHWARD S&S
[550]	商標種類： Mark Type:	Ordinary
	一系列商標： Series Mark:	No
[571]	商標描述： Mark Description:	N/A
[730]	註冊申請人的 姓名／名稱、地址： Applicant(s) Name,Address:	ILLINUS, INC. P.O. BOX 100, PMB-154, MAMMOTH LAKES, CA 93546, UNITED STATES OF AMERICA.
[740/ 750]	註冊申請人的送達地址： Applicant's Address for Service:	SIMMONS & SIMMONS 35TH FLOOR, CHEUNG KONG CENTER, 2 QUEEN'S ROAD CENTRAL, HONG KONG.
[511]	類別編號： Class(es) No(s).:	25, 28
[511]	貨品／服務說明： Specification:	Class 28: skis, snowboards, snowskates, skateboards.
[526]	卸棄： Disclaimer:	N/A
[529]	限制： Limitation:	N/A
[527]	條件： Condition:	N/A
	其他： Others	N/A
[220]	提交日期： Date of Filing:	17-02-2005
[320]	聲稱具有優先權的日期： Dates of Priority Claimed:	N/A
[310]	優先權申請編號： Priority Application No.:	N/A

[330]	優先權申請的國家、地區、地方： Country, Territory, Area of Priority Applications:	N/A
[210]	商標申請編號： Application No.:	300375688
[540]	商標： Mark:	FURRYVILLE
[550]	商標種類： Mark Type:	Ordinary
	一系列商標： Series Mark:	No
[571]	商標描述： Mark Description:	N/A
[730]	註冊申請人的姓名／名稱、地址： Applicant(s)' Name,Address:	MATTEL, INC. 333, CONTINENTAL BOULEVARD, EI SEGUNDO, CALIFORNIA 90245-5012, UNITED STATES OF AMERICA.
[740/750]	註冊申請人的送達地址： Applicant's Address for Service:	LOVELLS 23RD FLOOR, CHEUNG KONG CENTER, 2 QUEEN'S ROAD CENTRAL, HONG KONG.
[511]	類別編號： Class(es) No(s):	28
[511]	貨品／服務說明： Specification:	Class 28: gymnastic and sporting articles not included in other classes; stuffed toy animals; toys and sporting goods, games and playthings; dolls, doll clothing and doll accessories; doll furniture; doll houses; playsets featuring dolls, doll clothing, doll furniture; doll carriers; doll cribs; doll highchairs; doll bassinets; doll strollers; toy animals, and doll accessories; porcelain dolls; paper dolls; doll cases; toy animals; play tents; play houses; action figures and accessories therefor; plush toys; balloons; bathtub toys; ride-on toys; toy vehicles; radio-controlled toy vehicles; flying discs; electronic hand-held game units; a board game, a card game, a parlor game; jigsaw and manipulative puzzles; paper face masks; skateboards; ice skates; in-line skates; water squirting toys; balls, namely, playground balls, soccer balls; baseballs, basketballs; paddle ball games; surfboards; swim goggles; swimming floats for recreational use; kickboard flotation devices for recreational use; swim boards for recreational use; swim fins; toy bakeware and toy cookware; toy banks; toy snow globes; Christmas tree ornaments; children's play cosmetics; toy jewelry; party favors; plush toys; toy scooters; toy boxes; bean bags; building toys; play wands; music box toys; toy mobiles; jump ropes; kites; musical toys; puppets; drawing toys; sand toys; sand box toys; talking toys; outdoor play equipment, plastic toy hoops, pinwheels.
[526]	卸棄： Disclaimer:	N/A
[529]	限制： Limitation:	N/A
[527]	條件： Condition:	N/A
	其他： Others	N/A
[220]	提交日期： Date of Filing:	24-02-2005
[320]	聲稱具有優先權的日期： Dates of Priority Claimed:	N/A
[310]	優先權申請編號：	N/A

[330]	Priority Application No.: 優先權申請的國家、地區、地方： Country, Territory, Area of Priority Applications:	N/A
<hr/>		
[210]	商標申請編號： Application No.:	300375697
[540]	商標： Mark:	DOGGIE DAYCARE
[550]	商標種類： Mark Type:	Ordinary
[571]	一系列商標： Series Mark:	No
[730]	商標描述： Mark Description:	N/A
[740/750]	註冊申請人的姓名／名稱、地址： Applicant(s) Name, Address: 註冊申請人的送達地址： Applicant's Address for Service:	MATTEL, INC. 333, CONTINENTAL BOULEVARD, EI SEGUNDO, CALIFORNIA 90245-5012, UNITED STATES OF AMERICA. LOVELLS 23RD FLOOR, CHEUNG KONG CENTER, 2 QUEEN'S ROAD CENTRAL, HONG KONG.
[511]	類別編號： Class(es) No(s).:	28
[511]	貨品／服務說明： Specification:	Class 28: gymnastic and sporting articles not included in other classes; stuffed toy animals; toys and sporting goods, games and playthings; dolls, doll clothing and doll accessories; doll furniture; doll houses; playsets featuring dolls, doll clothing, doll furniture; doll carriers; doll cribs; doll highchairs; doll bassinets; doll strollers; toy animals, and doll accessories; porcelain dolls; paper dolls; doll cases; toy animals; play tents; play houses; action figures and accessories therefor; plush toys; balloons; bathtub toys; ride-on toys; toy vehicles; radio-controlled toy vehicles; flying discs; electronic hand-held game units; a board game, a card game, a parlor game; jigsaw and manipulative puzzles; paper face masks; skateboards; ice skates; in-line skates; water squirting toys; balls, namely, playground balls, soccer balls, baseballs, basketballs; paddle ball games; surfboards; swim goggles; swimming floats for recreational use; kickboard flotation devices for recreational use; swim boards for recreational use; swim fins; toy bakeware and toy cookware; toy banks; toy snow globes; Christmas tree ornaments; children's play cosmetics; toy jewelry; party favors; plush toys; toy scooters; toy boxes; bean bags; building toys; play wands; music box toys; toy mobiles; jump ropes; kites; musical toys; puppets; water-squirting toys; drawing toys; sand toys; sand box toys; talking toys; outdoor play equipment, plastic toy hoops, pinwheels.
[526]	卸棄： Disclaimer:	N/A
[529]	限制： Limitation:	N/A
[527]	條件： Condition:	N/A
[220]	其他： Others	N/A
[320]	提交日期： Date of Filing:	24-02-2005
[320]	聲稱具有優先權的日期： Dates of Priority Claimed:	N/A

[310]	優先權申請編號： Priority Application No.:	N/A
[330]	優先權申請的國家、地區、地方： Country, Territory, Area of Priority Applications:	N/A
<hr/>		
[210]	商標申請編號： Application No.:	300378117
[540]	商標： Mark:	
[550]	商標種類： Mark Type:	Ordinary
	一系列商標： Series Mark:	No
[571]	商標描述： Mark Description:	N/A
[730]	註冊申請人的姓名／名稱、地址： Applicant(s) Name,Address:	LANARD TOYS LIMITED 6TH FLOOR, ENERGY PLAZA, 92 GRANVILLE ROAD, TSIMSHATSUI, KOWLOON, HONG KONG SAR.
[740/750]	註冊申請人的送達地址： Applicant's Address for Service:	LANARD TOYS LIMITED 6TH FLOOR, ENERGY PLAZA, 92 GRANVILLE ROAD, TSIMSHATSUI, KOWLOON, HKSAR.
[511]	類別編號： Class(es) No(s):	28
[511]	貨品／服務說明： Specification:	Class 28: dolls; doll clothing and accessories; doll playsets and accessories therefor; dolls' heads with hair for styling purpose and with voice features and hair styling accessories therefor; toy vehicles and accessories therefor; toy animal figures and accessories therefor; Christmas tree ornaments; all included in Class 28.
[526]	卸棄： Disclaimer:	N/A
[529]	限制： Limitation:	N/A
[527]	條件： Condition:	N/A
	其他： Others	N/A
[220]	提交日期： Date of Filing:	02-03-2005
[320]	聲稱具有優先權的日期： Dates of Priority Claimed:	N/A
[310]	優先權申請編號： Priority Application No.:	N/A
[330]	優先權申請的國家、地區、地	N/A

方：

Country, Territory, Area of Priority

Applications:

[210]	商標申請編號： Application No.:	300378126
[540]	商標： Mark:	CATWALK KITTIES
[550]	商標種類： Mark Type:	Ordinary
	一系列商標： Series Mark:	No
[571]	商標描述： Mark Description:	N/A
[730]	註冊申請人的 姓名／名稱、地址： Applicant(s)' Name,Address:	LANARD TOYS LIMITED 6TH FLOOR, ENERGY PLAZA, 92 GRANVILLE ROAD, TSIMSHATSUI, KOWLOON, HONG KONG SAR.
[740/ 750]	註冊申請人的送達地址： Applicant's Address for Service:	LANARD TOYS LIMITED 6TH FLOOR, ENERGY PLAZA, 92 GRANVILLE ROAD, TSIMSHATSUI, KOWLOON, HKSAR.
[511]	類別編號： Class(es) No(s).:	28
[511]	貨品／服務說明： Specification:	Class 28: dolls; doll clothing and accessories; doll playsets and accessories therefor; dolls' heads with hair for styling purpose and with voice features and hair styling accessories therefore; toy vehicles and accessories therefor; toy animal figures and accessories therefor; Christmas tree ornaments; all included in Class 28.
[526]	卸棄： Disclaimer:	N/A
[529]	限制： Limitation:	N/A
[527]	條件： Condition:	N/A
	其他： Others	N/A
[220]	提交日期： Date of Filing:	02-03-2005
[320]	聲稱具有優先權的日期： Dates of Priority Claimed:	N/A
[310]	優先權申請編號： Priority Application No.:	N/A
[330]	優先權申請的國家、地區、地 方： Country, Territory, Area of Priority Applications:	N/A

[210]	商標申請編號： Application No.:	300378135
[540]	商標： Mark:	GABBY GIRLS

[550]	商標種類： Mark Type:	Ordinary
	一系列商標： Series Mark:	No
[571]	商標描述： Mark Description:	N/A
[730]	註冊申請人的 姓名／名稱、地址：	LANARD TOYS LIMITED 6TH FLOOR, ENERGY PLAZA, 92 GRANVILLE ROAD, TSIMSHATSUI, KOWLOON, HONG KONG SAR.
[740/ 750]	註冊申請人的送達地址： Applicant's Address for Service:	LANARD TOYS LIMITED 6TH FLOOR, ENERGY PLAZA, 92 GRANVILLE ROAD, TSIMSHATSUI, KOWLOON, HKSAR.
[511]	類別編號： Class(es) No(s):	28
[511]	貨品／服務說明： Specification:	Class 28: dolls; doll clothing and accessories; doll playsets and accessories therefor; dolls' heads with hair for styling purpose and with voice features and hair styling accessories therefor; toy vehicles and accessories therefor; toy animal figures and accessories therefor; Christmas tree ornaments; all included in Class 28.
[526]	卸棄： Disclaimer:	N/A
[529]	限制： Limitation:	N/A
[527]	條件： Condition:	N/A
	其他： Others	N/A
[220]	提交日期： Date of Filing:	02-03-2005
[320]	聲稱具有優先權的日期： Dates of Priority Claimed:	N/A
[310]	優先權申請編號： Priority Application No.:	N/A
[330]	優先權申請的國家、地區、地 方： Country, Territory, Area of Priority Applications:	N/A

[210] 商標申請編號：
Application No.: 300379080

[540] 商標：
Mark:



[550] 商標種類： Ordinary
 Mark Type:
 一系列商標： No
 Series Mark:
 [571] 商標描述： N/A
 Mark Description:
 [730] 註冊申請人的 NOKIA CORPORATION
 姓名／名稱、地址： KEILALAHDENTIE 4, 02150 ESPOO, FINLAND.
 Applicant(s)' Name,Address:
 [740/ 註冊申請人的送達地址： ELLA CHEONG (HK)
 750] Applicant's Address for Service: 3701 CENTRAL PLAZA, 18 HARBOUR ROAD, HONG KONG.
 [511] 類別編號： 9, 28
 Class(es) No(s):
 [511] 貨品／服務說明： Class 28:
 Specification: Games; hand held units for playing electronic games; hand held units for playing video games; electronic games; mobile phone controlled toy vehicles, dolls, kites and model planes.
 [526] 卸棄： N/A
 Disclaimer:
 [529] 限制： N/A
 Limitation:
 [527] 條件： N/A
 Condition:
 其他： N/A
 Others
 [220] 提交日期： 03-03-2005
 Date of Filing:
 [320] 聲稱具有優先權的日期： 06-09-2004
 Dates of Priority Claimed:
 [310] 優先權申請編號： T200402173
 Priority Application No.:
 [330] 優先權申請的國家、地區、地 Finland
 方：
 Country, Territory, Area of Priority Applications:

[210] 商標申請編號： 300382347

Application No.:
[540] 商標：
Mark:



[550] 商標種類： 一般商標
Mark Type:
一系列商標： 否
Series Mark:
[571] 商標描述： 不適用
Mark Description:
[730] 註冊申請人的 奇峰廣告製作有限公司
姓名／名稱、地址： 香港 北角英皇道 83 號 聯合出版大廈 1401 室
Applicant(s)' Name,Address:
[740/ 註冊申請人的送達地址： 奇峰廣告製作有限公司
750] Applicant's Address for Service: 香港 北角英皇道 83 號 聯合出版大廈 1401 室
[511] 類別編號： 9, 14, 16, 18, 21, 22, 25, 28
Class(es) No(s).:
[511] 貨品／服務說明： 類別 28:
Specification: 娛樂品、玩具。
[526] 卸棄： 不適用
Disclaimer:
[529] 限制： 不適用
Limitation:
[527] 條件： 不適用
Condition:
其他： 不適用
Others
[220] 提交日期： 09-03-2005
Date of Filing:
[320] 聲稱具有優先權的日期： 不適用
Dates of Priority Claimed:
[310] 優先權申請編號： 不適用
Priority Application No.:
[330] 優先權申請的國家、地區、地 不適用
方：
Country, Territory, Area of Priority
Applications:

[210] 商標申請編號： 300387568
Application No.:

[540] 商標：
Mark:



[550] 商標種類： Ordinary
Mark Type:
一系列商標： No
Series Mark:

[571] 商標描述： N/A
Mark Description:

[730] 註冊申請人的 YUGEN KAISHA DEVIL ROBOTS (DEVIL ROBOTS INCORPORATED)
姓名／名稱、地址： 2F MURAKAMI-BUILDING, 4-28 SUIDO-CHO, SHINJUKU-KU, TOKYO 162-
Applicant(s) Name,Address: 0811, JAPAN.

[740/ 註冊申請人的送達地址： EMILY YIP & CO
750] Applicant's Address for Service: ROOM 2510, HOPEWELL CENTRE, 183 QUEEN'S ROAD EAST, HONG KONG.

[511] 類別編號： 25, 28
Class(es) No(s).:

[511] 貨品／服務說明： Class 28:
Specification: Games and playthings; gymnastic and sporting articles not included in other classes; decorations for Christmas trees; butterfly nets; all included in Class 28.

[526] 卸棄： N/A
Disclaimer:

[529] 限制： N/A
Limitation:

[527] 條件： N/A
Condition:

其他： N/A
Others

[220] 提交日期： 17-03-2005
Date of Filing:

[320] 聲稱具有優先權的日期： N/A
Dates of Priority Claimed:

[310] 優先權申請編號： N/A
Priority Application No.:

[330] 優先權申請的國家、地區、地 N/A
方：
Country, Territory, Area of Priority
Applications:

[210] 商標申請編號： 300387595
Application No.:

[540] 商標：
Mark:

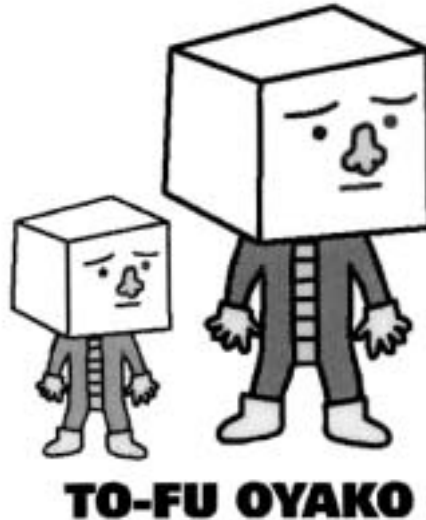

- [550] 商標種類： Ordinary
Mark Type:
一系列商標： No
Series Mark:
- [571] 商標描述： N/A
Mark Description:
- [730] 註冊申請人的 YUGEN KAISHA DEVIL ROBOTS (DEVIL ROBOTS INCORPORATED)
姓名／名稱、地址： 2F MURAKAMI-BUILDING, 4-28 SUIDO-CHO, SHINJUKU-KU, TOKYO 162-0811, JAPAN.
Applicant(s)' Name,Address:
- [740/ 註冊申請人的送達地址： EMILY YIP & CO
750] Applicant's Address for Service: ROOM 2510, HOPEWELL CENTRE, 183 QUEEN'S ROAD EAST, HONG KONG.
- [511] 類別編號： 25, 28
Class(es) No(s):
- [511] 貨品／服務說明： Class 28:
Specification: Games and playthings; gymnastic and sporting articles not included in other classes; decorations for Christmas trees; butterfly nets; all included in Class 28.
- [526] 卸棄： N/A
Disclaimer:
- [529] 限制： N/A
Limitation:
- [527] 條件： N/A
Condition:
其他： N/A
Others
- [220] 提交日期： 17-03-2005
Date of Filing:
- [320] 聲稱具有優先權的日期： N/A
Dates of Priority Claimed:
- [310] 優先權申請編號： N/A
Priority Application No.:
- [330] 優先權申請的國家、地區、地方： N/A
Country, Territory, Area of Priority Applications:

- [210] 商標申請編號 : 300388477
Application No.:
- [540] 商標 :
Mark: **MAGNETIX MAGNAWORLD**
- [550] 商標種類 : Ordinary
Mark Type:
一系列商標 : No
Series Mark:
- [571] 商標描述 : N/A
Mark Description:
- [730] 註冊申請人的姓名/名稱、地址 : ROSE ART INDUSTRIES, INC.
6 REGENT STREET, LIVINGSTON, NEW JERSEY, 07039, UNITED STATES.
Applicant(s) Name,Address:
- [740/750] 註冊申請人的送達地址 : DEACONS, SOLICITORS & NOTARIES, AGENTS FOR TRADE MARKS & PATENTS
Applicant's Address for Service: ALEXANDRA HOUSE, 3RD-7TH, 18TH AND 29TH FLOORS, CENTRAL, HONG KONG.
- [511] 類別編號 : 28
Class(es) No(s):
- [511] 貨品/服務說明 : Class 28:
Specification: Multi-part construction toys; not including magnetic sketch boards.
- [526] 卸棄 : N/A
Disclaimer:
- [529] 限制 : N/A
Limitation:
- [527] 條件 : N/A
Condition:
其他 : N/A
Others
- [220] 提交日期 : 18-03-2005
Date of Filing:
- [320] 聲稱具有優先權的日期 : 11-01-2005
Dates of Priority Claimed:
- [310] 優先權申請編號 : 78/545482
Priority Application No.:
- [330] 優先權申請的國家、地區、地方 : UNITED STATES
Country, Territory, Area of Priority Applications:

類別 Class 29

[210] 商標申請編號 : 300245150

Application No.:

[540] 商標 :

Mark:

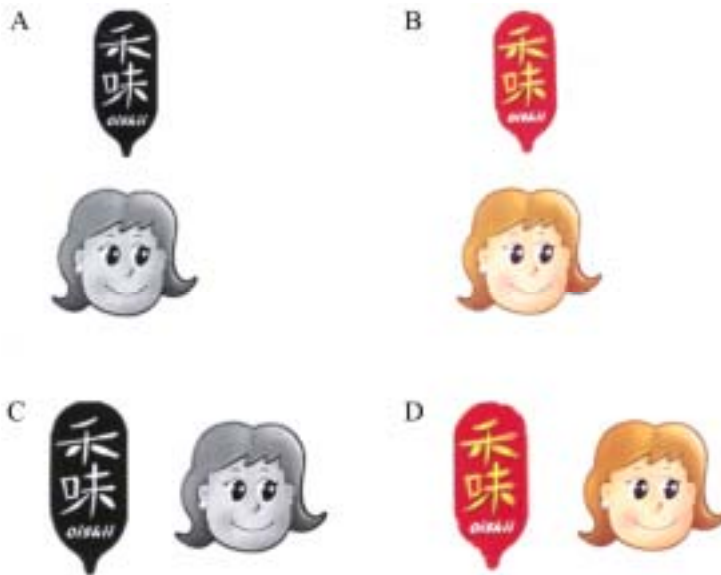

[550] 商標種類 : Ordinary

Mark Type:

一系列商標 :

Yes

Series Mark:

[571] 商標描述 :

Mark Description:

The applicant claims the colours yellow, red, white, brown and pink as elements of marks "B" and "D" in the series.

[730] 註冊申請人的

姓名/名稱、地址 :

BANGKOK MERCANTILE INTERNATIONAL FOOD PRODUCTS CO. LTD.
1/F., 68 BONHAM STRAND WEST, SHEUNG WAN, HONG KONG.

Applicant(s) Name,Address:

[740/

註冊申請人的送達地址 :

750] Applicant's Address for Service:

FOO & LI
ROOM 1001, 10TH FLOOR, NEW WORLD TOWER I, 18 QUEEN'S ROAD
CENTRAL, HONG KONG.

[511] 類別編號 :

Class(es) No(s):

29

[511] 貨品/服務說明 :

Specification:

Class 29:
meat, fish, poultry and game; meat extracts; sea foods; preserved, dried, frozen,
canned and cooked fruits and vegetables; jellies; jams; eggs; cheese, milk and milk
products; snack food; edible oils and fats; edible bird's nests; potato chips; all
included in Class 29.

[526] 卸棄 :

Disclaimer:

N/A

[529] 限制 :

Limitation:

N/A

[527] 條件 :

Condition:

N/A

其他 :

By consent, Trade Marks Nos. 2003B09155 and 200405029.

Others

[220] 提交日期 :

Date of Filing:

07-07-2004

[320] 聲稱具有優先權的日期 :

Dates of Priority Claimed:

N/A

[310] 優先權申請編號 :

Priority Application No.:

N/A

[330] 優先權申請的國家、地區、地

方 :

Country, Territory, Area of Priority

N/A

Applications:

[210]	商標申請編號： Application No.:	300297432
[540]	商標： Mark:	
[550]	商標種類： Mark Type:	Ordinary
	一系列商標： Series Mark:	No
[571]	商標描述： Mark Description:	N/A
[730]	註冊申請人的 姓名／名稱、地址： Applicant(s) Name,Address:	NISSHIN OILLIO GROUP KABUSHIKI KAISHA (THE NISSHIN OILLIO GROUP, LTD.) 23-1, SHINKAWA 1-CHOME, CHUO-KU, TOKYO, 104-8285, JAPAN.
[740/ 750]	註冊申請人的送達地址： Applicant's Address for Service:	UNION PATENT SERVICE CENTRE 1302 TUNG WAI COMMERCIAL BUILDING, 111 GLOUCESTER ROAD, HONG KONG.
[511]	類別編號： Class(es) No(s).:	29
[511]	貨品／服務說明： Specification:	Class 29: edible oils; edible fats; margarine.
[526]	卸棄： Disclaimer:	N/A
[529]	限制： Limitation:	N/A
[527]	條件： Condition:	N/A
	其他： Others	By consent, No. 300264014.
[220]	提交日期： Date of Filing:	07-10-2004
[320]	聲稱具有優先權的日期： Dates of Priority Claimed:	N/A
[310]	優先權申請編號： Priority Application No.:	N/A
[330]	優先權申請的國家、地區、地 方： Country, Territory, Area of Priority Applications:	N/A

[210] 商標申請編號：
Application No.: 300322370

[540]	商標： Mark:	清新滋選
[550]	商標種類： Mark Type:	Ordinary
	一系列商標： Series Mark:	No
[571]	商標描述： Mark Description:	N/A
[730]	註冊申請人的 姓名／名稱、地址： Applicant(s)' Name,Address:	MCDONALD'S CORPORATION ONE MCDONALD'S PLAZA, OAK BROOK, ILLINOIS 60523, UNITED STATES OF AMERICA.
[740/ 750]	註冊申請人的送達地址： Applicant's Address for Service:	MARKS & CLERK 20/F, CHINACHEM HOLLYWOOD CENTRE, 1-13 HOLLYWOOD ROAD, CENTRAL, HONG KONG.
[511]	類別編號： Class(es) No(s):	29, 30, 43
[511]	貨品／服務說明： Specification:	Class 29: foods prepared from meat, pork, fish and poultry products; prepared meals; preserved and cooked fruits and vegetables; eggs, cheese, milk, milk preparations; pickles; desserts; all included in Class 29. Class 30: prepared meals; edible sandwiches; meat sandwiches; pork sandwiches; fish sandwiches; chicken sandwiches; biscuits; bread; cakes; cookies; chocolate; coffee; coffee substitutes; tea; mustard; oatmeal; pastries; sauces; seasonings; sugar; all included in Class 30. Class 43: restaurant services; catering services; operating restaurants and other establishments or facilities for provision of food and drinks; preparation of carry-out or take-away foods and drinks.
[526]	卸棄： Disclaimer:	N/A
[529]	限制： Limitation:	N/A
[527]	條件： Condition:	N/A
	其他： Others	N/A
[220]	提交日期： Date of Filing:	19-11-2004
[320]	聲稱具有優先權的日期： Dates of Priority Claimed:	N/A
[310]	優先權申請編號： Priority Application No.:	N/A
[330]	優先權申請的國家、地區、地 方： Country, Territory, Area of Priority Applications:	N/A

[210] 商標申請編號：
Application No.: 300348633

- [540] 商標：
Mark:
- 
- [550] 商標種類：
Mark Type: 一般商標
一系列商標：
Series Mark: 否
- [571] 商標描述：
Mark Description: 不適用
- [730] 註冊申請人的
姓名／名稱、地址：
Applicant(s)' Name,Address: 福建雪津啤酒集團公司
中國 福建省莆田市 涵江區工業路 660 號
- [740/
750] 註冊申請人的送達地址：
Applicant's Address for Service: 吳尊嚴
香港 鰂魚涌濱海街 5 號 中興大廈 21/F 19 室
- [511] 類別編號：
Class(es) No(s): 29, 30, 32
- [511] 貨品／服務說明：
Specification: 類別 29:
肉、魚、家禽及野味、肉汁、腌漬、乾製及煮熟的水果和蔬果、果凍、果醬、蜜餞、蛋、奶及乳製品、食用油和油脂。
類別 30:
咖啡、茶、可可、糖、米、木薯澱粉、西米、咖啡代用品；麵粉及穀類製品、麵包、糕點及糖果、冰制食品；蜂蜜、濃糖漿；鮮酵母、發酵粉；食鹽、芥末；醋、醬油(調味品)；香料；飲用冰。
類別 32:
啤酒；礦泉水和充氣水以及其他不含酒精的飲料；水果飲料及果汁；糖漿及其他供飲料用的制劑。
- [526] 卸棄：
Disclaimer: 不適用
- [529] 限制：
Limitation: 不適用
- [527] 條件：
Condition: 不適用
其他：
Others: 不適用
- [220] 提交日期：
Date of Filing: 04-01-2005
- [320] 聲稱具有優先權的日期：
Dates of Priority Claimed: 不適用
- [310] 優先權申請編號：
Priority Application No.: 不適用
- [330] 優先權申請的國家、地區、地方：
Country, Territory, Area of Priority Applications: 不適用
-
- [210] 商標申請編號：
Application No.: 300365067

[540] 商標：
Mark:



[550]	商標種類： Mark Type:	Ordinary
	一系列商標： Series Mark:	No
[571]	商標描述： Mark Description:	N/A
[730]	註冊申請人的 姓名／名稱、地址： Applicant(s)' Name, Address:	MAXIM BUSINESS DEVELOPMENT COMPANY OFFICE 03, 27TH FLOOR, NAM WO HONG BLDG, NO 148, WING LOK ST., SHEUNG WAN, HONG KONG.
[740/ 750]	註冊申請人的送達地址： Applicant's Address for Service:	MAXIM BUSINESS DEVELOPMENT COMPANY OFFICE 03, 27TH/FLOOR, NAM WO HONG BLDG, NO 148, WING LOK ST., SHEUNG WAN, HONG KONG.
[511]	類別編號： Class(es) No(s):	29
[511]	貨品／服務說明： Specification:	Class 29: abalone; soup.
[526]	卸棄： Disclaimer:	N/A
[529]	限制： Limitation:	N/A
[527]	條件： Condition:	N/A
	其他： Others	N/A
[220]	提交日期： Date of Filing:	02-02-2005
[320]	聲稱具有優先權的日期： Dates of Priority Claimed:	N/A
[310]	優先權申請編號： Priority Application No.:	N/A
[330]	優先權申請的國家、地區、地 方： Country, Territory, Area of Priority Applications:	N/A

- [210] 商標申請編號 : 300369333
Application No.:
- [540] 商標 : 
Mark:
- [550] 商標種類 : 一般商標
Mark Type:
一系列商標 : 否
Series Mark:
- [571] 商標描述 : 不適用
Mark Description:
- [730] 註冊申請人的 林肖芳
姓名/名稱、地址 : 香港 柴灣小西灣 藍灣半島 9 座 7B
Applicant(s) Name,Address:
- [740/ 註冊申請人的送達地址 : 林肖芳
750] Applicant's Address for Service: 香港 上環永樂街 177-183 號 永德商業中心 2303 室
- [511] 類別編號 : 29, 30
Class(es) No(s).:
- [511] 貨品/服務說明 : 類別 29:
Specification: 肉、肉汁、非活水產品、罐頭食品、腌漬、乾制水果及制品、腌制、乾制蔬菜、蛋及蛋制品、奶及乳制品、食用油脂、色拉、加工過的堅果、菌類乾制品、食物蛋白、豆腐制品。
類別 30:
咖啡、茶及茶葉代用品、糖、糖果、蜂蜜、麵包、糕點、方便食品、米、麵粉、麵條及米麵制品、膨化食品、豆粉、食用麵筋、食用澱粉、食用冰、食鹽、醬油、醋、味精、沙司、醬、調味粉、調味汁、調味品、酵母、食用香精、香料、雞粉。
- [526] 卸棄 : 不適用
Disclaimer:
- [529] 限制 : 不適用
Limitation:
- [527] 條件 : 不適用
Condition:
其他 : 不適用
Others
- [220] 提交日期 : 14-02-2005
Date of Filing:
- [320] 聲稱具有優先權的日期 : 不適用
Dates of Priority Claimed:
- [310] 優先權申請編號 : 不適用
Priority Application No.:
- [330] 優先權申請的國家、地區、地方 : 不適用
Country, Territory, Area of Priority Applications:
-

- [210] 商標申請編號 : 300373068
Application No.:

[540] 商標：
Mark:



[550] 商標種類： Ordinary
Mark Type:
一系列商標： No
Series Mark:

[571] 商標描述： N/A
Mark Description:

[730] 註冊申請人的 GELOSTAR S.E. ASIA COMPANY LIMITED
姓名／名稱、地址： 24TH FLOOR, SHUM TOWER, NO.268 DES VOEUX ROAD CENTRAL, HONG KONG.
Applicant(s) Name,Address:

[740/ 註冊申請人的送達地址： CHIU, SZETO & CHENG
750] Applicant's Address for Service: 17/F., C.M.A. BUILDING, 64 CONNAUGHT ROAD CENTRAL, HONG KONG.

[511] 類別編號： 29, 30
Class(es) No(s).:

[511] 貨品／服務說明： Class 29:
Specification: milk and milk products, yogurt, skimmed milk; all included in Class 29.
Class 30:
ice, ices, ice-creams and confectionery; preparations and flavourings (other than essential oils) for making ices and ice-creams; cakes; pies; natural sweeteners and sugar, sherbets and sorbets; all included in Class 30.

[526] 卸棄： N/A
Disclaimer:

[529] 限制： N/A
Limitation:

[527] 條件： N/A
Condition:

其他： N/A
Others

[220] 提交日期： 19-02-2005
Date of Filing:

[320] 聲稱具有優先權的日期： N/A
Dates of Priority Claimed:

[310] 優先權申請編號： N/A
Priority Application No.:

[330] 優先權申請的國家、地區、地方： N/A
Country, Territory, Area of Priority Applications:

[210] 商標申請編號： 300373347
Application No.:

[540] 商標：
Mark:

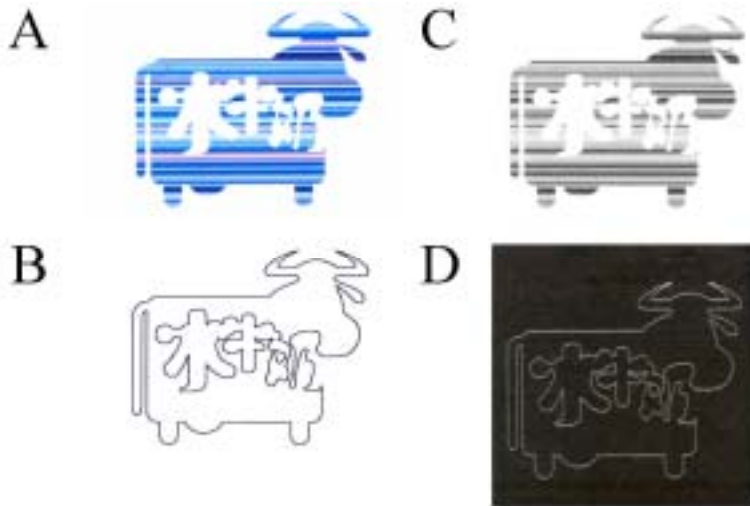

[550] 商標種類：
Mark Type: Ordinary
一系列商標：
Series Mark: Yes

[571] 商標描述：
Mark Description: N/A

[730] 註冊申請人的
姓名／名稱、地址：
Applicant(s)' Name,Address: SENSEFORD LTD
RM 1801-02, NORTH POINT ASIA-PAC CENTRE, 10 NORTH POINT ROAD,
HONG KONG.

[740/
750] 註冊申請人的送達地址：
Applicant's Address for Service: SENSEFORD LTD
RM 1801-02, NORTH POINT ASIA-PAC CENTRE, 10 NORTH POINT ROAD,
HONG KONG.

[511] 類別編號：
Class(es) No(s): 29, 30

[511] 貨品／服務說明：
Specification: Class 29:
milk and milk products; meat, fish, poultry & game; meat extracts; preserved, dried
and cooked fruits and vegetables; jellies, jams, fruit sauces; eggs; edible oils and fats.
Class 30:
coffee, tea, cocoa, sugar, rice, tapioca, sago, artificial coffee; flour and preparations
made from cereals, bread, pastry and confectionery, ices; honey, treacles; yeast,
baking powder, salt, mustard; vinegar, sauces (condiments); spices; ice.

[526] 卸棄：
Disclaimer: N/A

[529] 限制：
Limitation: N/A

[527] 條件：
Condition: N/A
其他：
Others: N/A

[220] 提交日期：
Date of Filing: 21-02-2005

[320] 聲稱具有優先權的日期：
Dates of Priority Claimed: N/A

[310] 優先權申請編號：
Priority Application No.: N/A

[330] 優先權申請的國家、地區、地
方：
Country, Territory, Area of Priority
Applications: N/A

[210] 商標申請編號 : 300379062

Application No.:

[540] 商標 :

Mark:



[550] 商標種類 : Ordinary

Mark Type:

一系列商標 :

Series Mark:

Yes

[571] 商標描述 :

Mark Description:

The applicant claims the colours red, white, yellow and orange as elements of mark "A" in the series.

[730] 註冊申請人的

姓名/名稱、地址 :

Applicant(s) Name,Address:

SEVEN SEAS LIMITED

HEDON ROAD, HULL, EAST YORKSHIRE, HU9 5NJ, UNITED KINGDOM.

[740/ 註冊申請人的送達地址 :

750] Applicant's Address for Service:

HASTINGS & CO.

5TH FLOOR, GLOUCESTER TOWER, THE LANDMARK, 11 PEDDER STREET, CENTRAL, HONG KONG.

[511] 類別編號 :

Class(es) No(s).:

5, 29

[511] 貨品/服務說明 :

Specification:

Class 29:

fish (none being live), seafood and food products made or derived from fish and seafood; nutritional supplements all included in Class 29; edible oils and edible fats; foodstuffs containing oils or fats.

[526] 卸棄 :

Disclaimer:

N/A

[529] 限制 :

Limitation:

N/A

[527] 條件 :

Condition:

N/A

其他 :

Others

N/A

[220] 提交日期 :

Date of Filing:

03-03-2005

[320] 聲稱具有優先權的日期 :

Dates of Priority Claimed:

N/A

[310] 優先權申請編號 :

Priority Application No.:

N/A

[330] 優先權申請的國家、地區、地

方 :

Country, Territory, Area of Priority

Applications:

N/A

[210] 商標申請編號： 300380916

Application No.:

[540] 商標：

Mark:



[550] 商標種類： 一般商標

Mark Type:

一系列商標：

否

Series Mark:

[571] 商標描述： 不適用

Mark Description:

[730] 註冊申請人的 鍾延籌

姓名／名稱、地址：

印度尼西亞 知玲巴史拉單二巷四號 椰加達

Applicant(s) Name,Address:

[740/ 註冊申請人的送達地址： 復興(香港)貿易有限公司

750] Applicant's Address for Service: 香港 柴灣康民街 2 號 康民工業中心 16 樓 01 室

[511] 類別編號： 29, 30, 32

Class(es) No(s).:

[511] 貨品／服務說明： 類別 29:

Specification:

果凍。

類別 30:

糖、米。

類別 32:

水果飲料。

[526] 卸棄： 不適用

Disclaimer:

[529] 限制： 不適用

Limitation:

[527] 條件： 不適用

Condition:

其他： 不適用

Others

[220] 提交日期： 07-03-2005

Date of Filing:

[320] 聲稱具有優先權的日期： 不適用

Dates of Priority Claimed:

[310] 優先權申請編號： 不適用

Priority Application No.:

[330] 優先權申請的國家、地區、地方： 不適用

Country, Territory, Area of Priority Applications:

[210]	商標申請編號 : Application No.:	300388468
[540]	商標 : Mark:	ACTISMILE
[550]	商標種類 : Mark Type:	Ordinary
	一系列商標 : Series Mark:	No
[571]	商標描述 : Mark Description:	N/A
[730]	註冊申請人的 姓名/名稱、地址 : Applicant(s) Name,Address:	SOCIÉTÉ DES PRODUITS NESTLÉ S.A. 1800 VEVEY, SWITZERLAND.
[740/ 750]	註冊申請人的送達地址 : Applicant's Address for Service:	DEACONS, SOLICITORS & NOTARIES, AGENTS FOR TRADE MARKS & PATENTS ALEXANDRA HOUSE, 3RD-7TH, 18TH AND 29TH FLOORS, CENTRAL, HONG KONG.
[511]	類別編號 : Class(es) No(s):	5, 29, 30, 32
[511]	貨品/服務說明 : Specification:	Class 29: Vegetables and potatoes (preserved, dried or cooked), fruits (preserved, dried or cooked), mushrooms (preserved, dried or cooked), meat, poultry, game, fish and seafood, all these products also in the form of extracts, soups, jellies, pastes, preserves, ready-made dishes, frozen or dehydrated; jams; eggs; milk, milk-based products, casein, whey, cream, butter, cheese and other food preparations having a base of milk; milk substitutes; milk-based beverages; milk-based and cream-based desserts; yoghurts; soya milk (milk substitute), soya-based preparations; edible oils and fats; protein preparations for human food; non-dairy creamers; sausages; charcuterie; peanut butter; soups, soup concentrates, broth, stock cubes, bouillon, consommés.
[526]	卸棄 : Disclaimer:	N/A
[529]	限制 : Limitation:	N/A
[527]	條件 : Condition:	N/A
	其他 : Others	N/A
[220]	提交日期 : Date of Filing:	18-03-2005
[320]	聲稱具有優先權的日期 : Dates of Priority Claimed:	09-02-2005
[310]	優先權申請編號 : Priority Application No.:	51028 2005
[330]	優先權申請的國家、地區、地方 : Country, Territory, Area of Priority Applications:	Switzerland

類別 Class 30

- [210] 商標申請編號 : 300322370
Application No.:
- [540] 商標 : 清新滋選
Mark:
- [550] 商標種類 : Ordinary
Mark Type:
一系列商標 : No
Series Mark:
- [571] 商標描述 : N/A
Mark Description:
- [730] 註冊申請人的 MCDONALD'S CORPORATION
姓名/名稱、地址 : ONE MCDONALD'S PLAZA, OAK BROOK, ILLINOIS 60523, UNITED STATES
Applicant(s) Name,Address: OF AMERICA.
- [740/ 註冊申請人的送達地址 : MARKS & CLERK
750] Applicant's Address for Service: 20/F, CHINACHEM HOLLYWOOD CENTRE, 1-13 HOLLYWOOD ROAD, CENTRAL, HONG KONG.
- [511] 類別編號 : 29, 30, 43
Class(es) No(s):
- [511] 貨品/服務說明 : Class 30:
Specification: prepared meals; edible sandwiches; meat sandwiches; pork sandwiches; fish sandwiches; chicken sandwiches; biscuits; bread; cakes; cookies; chocolate; coffee; coffee substitutes; tea; mustard; oatmeal; pastries; sauces; seasonings; sugar; all included in Class 30.
- [526] 卸棄 : N/A
Disclaimer:
- [529] 限制 : N/A
Limitation:
- [527] 條件 : N/A
Condition:
其他 : N/A
Others
- [220] 提交日期 : 19-11-2004
Date of Filing:
- [320] 聲稱具有優先權的日期 : N/A
Dates of Priority Claimed:
- [310] 優先權申請編號 : N/A
Priority Application No.:
- [330] 優先權申請的國家、地區、地方 : N/A
Country, Territory, Area of Priority Applications:
-
-

- [210] 商標申請編號 : 300340235
Application No.:
- [540] 商標 : 香港良品
Mark:
- [550] 商標種類 : 一般商標
Mark Type:
一系列商標 : 否
Series Mark:

[571]	商標描述： Mark Description:	不適用
[730]	註冊申請人的 姓名／名稱、地址： Applicant(s)' Name,Address:	崑亮有限公司 香港 新界屯門業旺路 6 號 聯昌中心 604 室
[740/ 750]	註冊申請人的送達地址： Applicant's Address for Service:	崑亮有限公司 香港 新界屯門業旺路 6 號 聯昌中心 604 室
[511]	類別編號： Class(es) No(s):	24, 30
[511]	貨品／服務說明： Specification:	類別 30: 可可、糖、米、木薯澱粉、西米、咖啡代用品；蜂蜜、濃糖漿；鮮酵母、發酵粉；食鹽、芥末；醋、醬油(調味品)；香料；飲用冰。
[526]	卸棄： Disclaimer:	不適用
[529]	限制： Limitation:	不適用
[527]	條件： Condition:	不適用
	其他： Others	不適用
[220]	提交日期： Date of Filing:	20-12-2004
[320]	聲稱具有優先權的日期： Dates of Priority Claimed:	不適用
[310]	優先權申請編號： Priority Application No.:	不適用
[330]	優先權申請的國家、地區、地 方： Country, Territory, Area of Priority Applications:	不適用

[210] 商標申請編號：
Application No.: 300348633

[540] 商標：
Mark:



[550] 商標種類：
Mark Type: 一般商標

一系列商標：
Series Mark: 否

[571] 商標描述：
Mark Description: 不適用

[730] 註冊申請人的
姓名／名稱、地址：
Applicant(s)' Name,Address:

福建雪津啤酒集團公司
中國 福建省莆田市 涵江區工業路 660 號

[740/
750] 註冊申請人的送達地址：
Applicant's Address for Service:

吳尊嚴
香港 鯉魚涌濱海街 5 號 中興大廈 21/F 19 室

[511] 類別編號：
Class(es) No(s): 29, 30, 32

[511]	Class(es) No(s): 貨品／服務說明： Specification:	類別 30: 咖啡、茶、可可、糖、米、木薯澱粉、西米、咖啡代用品；麵粉及穀類制品、麵包、糕點及糖果、冰制食品；蜂蜜、濃糖漿；鮮酵母、發酵粉；食鹽、芥末；醋、醬油(調味品)；香料；飲用冰。
[526]	卸棄： Disclaimer:	不適用
[529]	限制： Limitation:	不適用
[527]	條件： Condition:	不適用
	其他： Others	不適用
[220]	提交日期： Date of Filing:	04-01-2005
[320]	聲稱具有優先權的日期： Dates of Priority Claimed:	不適用
[310]	優先權申請編號： Priority Application No.:	不適用
[330]	優先權申請的國家、地區、地方： Country, Territory, Area of Priority Applications:	不適用

[210] 商標申請編號：
Application No.: 300368596

[540] 商標：
Mark:



[550] 商標種類：
Mark Type: Ordinary

一系列商標：
Series Mark: No

[571] 商標描述：
Mark Description: N/A

[730] 註冊申請人的
姓名／名稱、地址：
Applicant(s)' Name,Address: HUANG JIN SONG
NO. 27, HI QI INNER STREET, SHAN TOU CITY, GUANGDONG PROVINCE,
CHINA.

[740/
750] 註冊申請人的送達地址：
Applicant's Address for Service: INTERMARK TRADEMARK CONSULTING LTD.
RM 703, KOWLOON BUILDING, 555 NATHAN ROAD, KOWLOON, HONG
KONG.

[511] 類別編號：
Class(es) No(s): 30

[511] 貨品／服務說明：
Specification: Class 30:
coffee; candy; mint candy; non-medicated nutritional powder; biscuits; cereal preparations; instant noodles; sizzling rice; starch products for food; ice cream;

[526]	卸棄： Disclaimer:	seasonings. N/A
[529]	限制： Limitation:	N/A
[527]	條件： Condition:	N/A
	其他： Others	N/A
[220]	提交日期： Date of Filing:	08-02-2005
[320]	聲稱具有優先權的日期： Dates of Priority Claimed:	N/A
[310]	優先權申請編號： Priority Application No.:	N/A
[330]	優先權申請的國家、地區、地 方： Country, Territory, Area of Priority Applications:	N/A

[210]	商標申請編號： Application No.:	300369333
[540]	商標： Mark:	



[550]	商標種類： Mark Type:	一般商標
	一系列商標： Series Mark:	否
[571]	商標描述： Mark Description:	不適用
[730]	註冊申請人的 姓名／名稱、地址： Applicant(s) Name,Address:	林肖芳 香港 柴灣小西灣 藍灣半島 9 座 7B
[740/ 750]	註冊申請人的送達地址： Applicant's Address for Service:	林肖芳 香港 上環永樂街 177-183 號 永德商業中心 2303 室
[511]	類別編號： Class(es) No(s).:	29, 30
[511]	貨品／服務說明： Specification:	類別 30: 咖啡、茶及茶葉代用品、糖、糖果、蜂蜜、麵包、糕點、方便食品、米、麵粉、麵條及米麵制品、膨化食品、豆粉、食用麵筋、食用澱粉、食用冰、食鹽、醬油、醋、味精、沙司、醬、調味粉、調味汁、調味品、酵母、食用香精、香料、雞粉。
[526]	卸棄： Disclaimer:	不適用
[529]	限制： Limitation:	不適用
[527]	條件： Condition:	不適用
	其他： Others	不適用

[220] 提交日期： 14-02-2005
Date of Filing:
[320] 聲稱具有優先權的日期： 不適用
Dates of Priority Claimed:
[310] 優先權申請編號： 不適用
Priority Application No.:
[330] 優先權申請的國家、地區、地方： 不適用
Country, Territory, Area of Priority Applications:

[210] 商標申請編號： 300369973
Application No.:
[540] 商標： 
Mark:

[550] 商標種類： Ordinary
Mark Type:
一系列商標： No
Series Mark:

[571] 商標描述： N/A
Mark Description:

[730] 註冊申請人的姓名／名稱、地址： SOCIETE DES PRODUITS NESTLE S.A.
1800 VEVEY, SWITZERLAND.
Applicant(s) Name,Address:

[740/750] 註冊申請人的送達地址： DEACONS, SOLICITORS & NOTARIES, AGENTS FOR TRADE MARKS & PATENTS
ALEXANDRA HOUSE, 3RD-7TH, 18TH AND 29TH FLOORS, CENTRAL, HONG KONG.
Applicant's Address for Service:

[511] 類別編號： 7, 9, 11, 30, 32
Class(es) No(s):

[511] 貨品／服務說明： Class 30:
Specification: Coffee, tea, cocoa.

[526] 卸棄： N/A
Disclaimer:

[529] 限制： N/A
Limitation:

[527] 條件： N/A
Condition:

其他： N/A
Others

[220] 提交日期： 14-02-2005
Date of Filing:

[320] 聲稱具有優先權的日期： N/A
Dates of Priority Claimed:

[310] 優先權申請編號： N/A
Priority Application No.:

[330] 優先權申請的國家、地區、地方： N/A
Country, Territory, Area of Priority Applications:

[210]	商標申請編號 : Application No.:	300372807
[540]	商標 : Mark:	
[550]	商標種類 : Mark Type:	Ordinary
	一系列商標 : Series Mark:	No
[571]	商標描述 : Mark Description:	N/A
[730]	註冊申請人的 姓名/名稱、地址 : Applicant(s) Name,Address:	BIODES, S.L. CALLE MARQUES DE LA ENSENADA, 16, MADRID, SPAIN.
[740/ 750]	註冊申請人的送達地址 : Applicant's Address for Service:	ALLENS ARTHUR ROBINSON 49/F., ONE EXCHANGE SQUARE, 8 CONNAUGHT PLACE, CENTRAL, HONG KONG.
[511]	類別編號 : Class(es) No(s).:	5, 30
[511]	貨品/服務說明 : Specification:	Class 30: tea, camomile, lime-blossom and natural herbs for non-medicinal herbal teas.
[526]	卸棄 : Disclaimer:	N/A
[529]	限制 : Limitation:	N/A
[527]	條件 : Condition:	N/A
	其他 : Others	N/A
[220]	提交日期 : Date of Filing:	18-02-2005
[320]	聲稱具有優先權的日期 : Dates of Priority Claimed:	N/A
[310]	優先權申請編號 : Priority Application No.:	N/A
[330]	優先權申請的國家、地區、地 方 : Country, Territory, Area of Priority Applications:	N/A

[210]	商標申請編號 : Application No.:	300373068
-------	------------------------------	-----------

[540] 商標：
Mark:



[550] 商標種類： Ordinary
Mark Type:
一系列商標： No
Series Mark:

[571] 商標描述： N/A
Mark Description:

[730] 註冊申請人的 GELOSTAR S.E. ASIA COMPANY LIMITED
姓名／名稱、地址： 24TH FLOOR, SHUM TOWER, NO.268 DES VOEUX ROAD CENTRAL, HONG KONG.
Applicant(s)' Name,Address:

[740/ 註冊申請人的送達地址： CHIU, SZETO & CHENG
750] Applicant's Address for Service: 17/F., C.M.A. BUILDING, 64 CONNAUGHT ROAD CENTRAL, HONG KONG.

[511] 類別編號： 29, 30
Class(es) No(s).:

[511] 貨品／服務說明： Class 30:
Specification: ice, ices, ice-creams and confectionery; preparations and flavourings (other than essential oils) for making ices and ice-creams; cakes; pies; natural sweeteners and sugar, sherbets and sorbets; all included in Class 30.

[526] 卸棄： N/A
Disclaimer:

[529] 限制： N/A
Limitation:

[527] 條件： N/A
Condition:

其他： N/A
Others

[220] 提交日期： 19-02-2005
Date of Filing:

[320] 聲稱具有優先權的日期： N/A
Dates of Priority Claimed:

[310] 優先權申請編號： N/A
Priority Application No.:

[330] 優先權申請的國家、地區、地方： N/A
Country, Territory, Area of Priority Applications:

[210] 商標申請編號： 300373347
Application No.:

[540] 商標：
Mark:

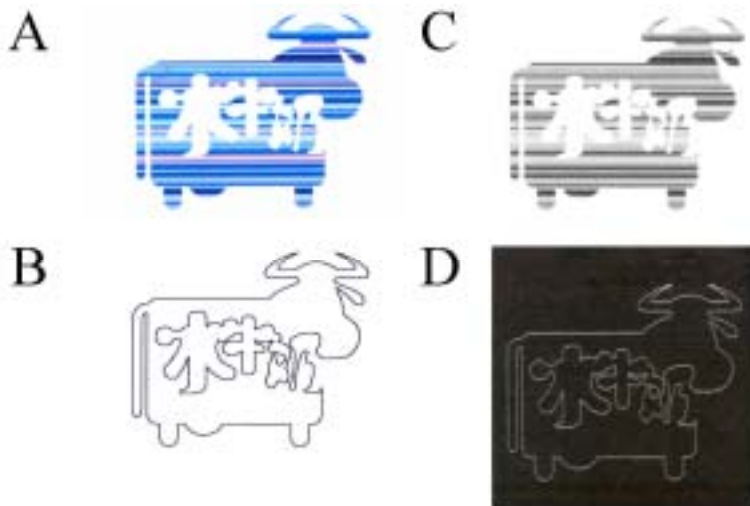

[550] 商標種類：
Mark Type: Ordinary
一系列商標：
Mark Type: Yes
Series Mark:
[571] 商標描述：
Mark Description: N/A
[730] 註冊申請人的
姓名／名稱、地址：
Applicant(s)' Name,Address: SENSEFORD LTD
RM 1801-02, NORTH POINT ASIA-PAC CENTRE, 10 NORTH POINT ROAD,
HONG KONG.
[740/
750] 註冊申請人的送達地址：
Applicant's Address for Service: SENSEFORD LTD
RM 1801-02, NORTH POINT ASIA-PAC CENTRE, 10 NORTH POINT ROAD,
HONG KONG.
[511] 類別編號：
Class(es) No(s): 29, 30
[511] 貨品／服務說明：
Specification: Class 30:
coffee, tea, cocoa, sugar, rice, tapioca, sago, artificial coffee; flour and preparations
made from cereals, bread, pastry and confectionery, ices; honey, treacles; yeast,
baking powder, salt, mustard; vinegar, sauces (condiments); spices; ice.
[526] 卸棄：
Disclaimer: N/A
[529] 限制：
Limitation: N/A
[527] 條件：
Condition: N/A
其他：
Others: N/A
[220] 提交日期：
Date of Filing: 21-02-2005
[320] 聲稱具有優先權的日期：
Dates of Priority Claimed: N/A
[310] 優先權申請編號：
Priority Application No.: N/A
[330] 優先權申請的國家、地區、地
方：
Country, Territory, Area of Priority
Applications: N/A

- [210] 商標申請編號 : 300378469
Application No.:
- [540] 商標 :
Mark: 
- [550] 商標種類 : Ordinary
Mark Type:
一系列商標 : No
Series Mark:
- [571] 商標描述 : The mark consists in part of a sound and the words "RI". "CO" and "LA".
Mark Description:
- [730] 註冊申請人的姓名/名稱、地址 : RICO LA AG (RICO LA LTD.)
Applicant(s) Name,Address: BASELSTRASSE 31, 4242 LAUFEN, SWITZERLAND.
- [740/750] 註冊申請人的送達地址 : DEACONS, SOLICITORS & NOTARIES, AGENTS FOR TRADE MARKS & PATENTS
Applicant's Address for Service: ALEXANDRA HOUSE, 3RD-7TH, 18TH AND 29TH FLOORS, CENTRAL, HONG KONG.
- [511] 類別編號 : 5, 30
Class(es) No(s).:
- [511] 貨品/服務說明 : Class 30:
Specification: Non-medicated candy, confectionery; non-medicated herbal teas.
- [526] 卸棄 : N/A
Disclaimer:
- [529] 限制 : N/A
Limitation:
- [527] 條件 : N/A
Condition:
其他 : N/A
Others
- [220] 提交日期 : 02-03-2005
Date of Filing:
- [320] 聲稱具有優先權的日期 : N/A
Dates of Priority Claimed:
- [310] 優先權申請編號 : N/A
Priority Application No.:
- [330] 優先權申請的國家、地區、地方 : N/A
Country, Territory, Area of Priority Applications:
-

- [210] 商標申請編號 : 300380916
Application No.:

[540] 商標：
Mark:



[550] 商標種類： 一般商標
Mark Type:
一系列商標： 否
Series Mark:
[571] 商標描述： 不適用
Mark Description:
[730] 註冊申請人的 鍾延籌
姓名／名稱、地址： 印度尼西亞 知玲巴史拉單二巷四號 椰加達
Applicant(s) Name,Address:
[740/
750] 註冊申請人的送達地址： 復興(香港)貿易有限公司
Applicant's Address for Service: 香港 柴灣康民街 2 號 康民工業中心 16 樓 01 室
[511] 類別編號： 29, 30, 32
Class(es) No(s).:
[511] 貨品／服務說明： 類別 30:
Specification: 糖、米。
[526] 卸棄： 不適用
Disclaimer:
[529] 限制： 不適用
Limitation:
[527] 條件： 不適用
Condition:
其他： 不適用
Others
[220] 提交日期： 07-03-2005
Date of Filing:
[320] 聲稱具有優先權的日期： 不適用
Dates of Priority Claimed:
[310] 優先權申請編號： 不適用
Priority Application No.:
[330] 優先權申請的國家、地區、地 不適用
方：
Country, Territory, Area of Priority
Applications:

[210] 商標申請編號： 300385579
Application No.:

[540] 商標：
Mark:



[550] 商標種類： Ordinary
 Mark Type:
 一系列商標： No
 Series Mark:
 [571] 商標描述： N/A
 Mark Description:
 [730] 註冊申請人的 CEYLON BISCUITS LIMITED
 姓名／名稱、地址： HIGH LEVEL ROAD, MAKUMBURA, PANNIPITIYA, SRI LANKA.
 Applicant(s)' Name,Address:
 [740/ 註冊申請人的送達地址： WENPING & CO.
 750] Applicant's Address for Service: ROOM 1701, TUNG WAI COMMERCIAL BUILDING, 111 GLOUCESTER ROAD, HONG KONG.
 [511] 類別編號： 30
 Class(es) No(s).:
 [511] 貨品／服務說明： Class 30:
 Specification: confectionery, chocolates and biscuits
 [526] 卸棄： N/A
 Disclaimer:
 [529] 限制： N/A
 Limitation:
 [527] 條件： N/A
 Condition:
 其他： N/A
 Others
 [220] 提交日期： 14-03-2005
 Date of Filing:
 [320] 聲稱具有優先權的日期： N/A
 Dates of Priority Claimed:
 [310] 優先權申請編號： N/A
 Priority Application No.:
 [330] 優先權申請的國家、地區、地 N/A
 方：
 Country, Territory, Area of Priority Applications:

[210] 商標申請編號： 300385588
 Application No.:

[540] 商標：
Mark:



[550] 商標種類： Ordinary
Mark Type:
一系列商標： No
Series Mark:
[571] 商標描述： N/A
Mark Description:
[730] 註冊申請人的 CEYLON BISCUITS LIMITED
姓名／名稱、地址： HIGH LEVEL ROAD, MAKUMBURA, PANNIPITIYA, SRI LANKA.
Applicant(s)' Name,Address:
[740/ 註冊申請人的送達地址： WENPING & CO.
750] Applicant's Address for Service: ROOM 1701, TUNG WAI COMMERCIAL BUILDING, 111 GLOUCESTER ROAD, HONG KONG.
[511] 類別編號： 30
Class(es) No(s):
[511] 貨品／服務說明： Class 30:
Specification: biscuits and confectionery
[526] 卸棄： N/A
Disclaimer:
[529] 限制： N/A
Limitation:
[527] 條件： N/A
Condition:
其他： N/A
Others
[220] 提交日期： 14-03-2005
Date of Filing:
[320] 聲稱具有優先權的日期： N/A
Dates of Priority Claimed:
[310] 優先權申請編號： N/A
Priority Application No.:
[330] 優先權申請的國家、地區、地 N/A
方：
Country, Territory, Area of Priority Applications:

[210] 商標申請編號： 300388161
Application No.:

[540] 商標：
Mark:

A **OAKSHEART**
B *OaksHeart*

[550] 商標種類： Ordinary
Mark Type:
一系列商標： Yes
Series Mark:

[571] 商標描述： N/A
Mark Description:

[730] 註冊申請人的 UCHIBORI JOZO KABUSHIKI KAISHA (UCHIBORI VINEGAR, INC.)
姓名／名稱、地址： 3922 YAOTSU YAOTSU-CHO KAMO-GUN GIFU-KEN, JAPAN.
Applicant(s)' Name,Address:

[740/ 註冊申請人的送達地址： EMILY YIP & CO
750] Applicant's Address for Service: ROOM 2510, HOPEWELL CENTRE, 183 QUEEN'S ROAD EAST, HONG KONG.

[511] 類別編號： 30, 32
Class(es) No(s):

[511] 貨品／服務說明： Class 30:
Specification: Vinegars including rice vinegar, wine vinegar, beer vinegar, fruit vinegar, apple vinegar, sushi vinegar, grain vinegar, mustard vinegar and pepper vinegar; vinegar mixes; salad dressings; sauces (condiments); seasonings; flavorings other than essential oils; coffee, cocoa, tea, confectionery, ice cream, sherbets, bread, pastries, ice cream mixes, sherbet mixes.
Class 32:
Non-alcoholic beverages, preparations for making beverages, beverages containing vinegar; fruit juices; vegetable juices (beverages); whey beverages.

[526] 卸棄： N/A
Disclaimer:

[529] 限制： N/A
Limitation:

[527] 條件： N/A
Condition:
其他： N/A
Others

[220] 提交日期： 18-03-2005
Date of Filing:

[320] 聲稱具有優先權的日期： N/A
Dates of Priority Claimed:

[310] 優先權申請編號： N/A
Priority Application No.:

[330] 優先權申請的國家、地區、地方： N/A
Country, Territory, Area of Priority Applications:

[210]	商標申請編號： Application No.:	300388468
[540]	商標： Mark:	ACTISMILE
[550]	商標種類： Mark Type:	Ordinary
	一系列商標： Series Mark:	No
[571]	商標描述： Mark Description:	N/A
[730]	註冊申請人的 姓名／名稱、地址： Applicant(s) Name,Address:	SOCIÉTÉ DES PRODUITS NESTLÉ S.A. 1800 VEVEY, SWITZERLAND.
[740/ 750]	註冊申請人的送達地址： Applicant's Address for Service:	DEACONS, SOLICITORS & NOTARIES, AGENTS FOR TRADE MARKS & PATENTS ALEXANDRA HOUSE, 3RD-7TH, 18TH AND 29TH FLOORS, CENTRAL, HONG KONG.
[511]	類別編號： Class(es) No(s).:	5, 29, 30, 32
[511]	貨品／服務說明： Specification:	Class 30: Coffee, coffee extracts, coffee-based preparations and beverages; iced coffee; coffee substitutes, extracts of coffee substitutes, preparations and beverages based on coffee substitutes; chicory; tea, tea extracts, tea-based preparations and beverages; iced tea; malt-based preparations; cocoa and cocoa-based preparations and beverages; chocolate, chocolate products, chocolate-based preparations and beverages; confectionery, sweets, candies; sugar; chewing gum; natural sweeteners; bakery products, bread, yeast, pastry; biscuits, cakes, cookies, wafers, toffees, puddings; ice cream, water ices, sherbets, frozen confections, frozen cakes, soft ices, frozen desserts, frozen yoghurts; binding agents for making ice cream and/or water ices and/or sherbets and/or frozen confections and/or frozen cakes and/or soft ices and/or frozen desserts and/or frozen yoghurts; honey and honey substitutes; breakfast cereals, muesli, corn flakes, cereal bars, ready-to-eat cereals; cereal preparations; rice, pasta, noodles; foodstuffs having a base of rice, of flour or of cereals, also in the form of ready-made dishes; pizzas; sandwiches; mixtures of alimentary paste and oven-ready prepared dough; sauces; soya sauce; ketchup; aromatising or seasoning products for food, edible spices, condiments, salad dressings, mayonnaise; mustard; vinegar.
[526]	卸棄： Disclaimer:	N/A
[529]	限制： Limitation:	N/A
[527]	條件： Condition:	N/A
	其他： Others	N/A
[220]	提交日期： Date of Filing:	18-03-2005
[320]	聲稱具有優先權的日期： Dates of Priority Claimed:	09-02-2005
[310]	優先權申請編號： Priority Application No.:	51028 2005
[330]	優先權申請的國家、地區、地方： Country, Territory, Area of Priority Applications:	Switzerland

