

# 香港知識產權公報

Hong Kong Intellectual Property Journal

2020年4月3日

03 April 2020



## 目錄 Contents

### 根據註冊外觀設計條例第 25 條註冊的外觀設計

#### **Designs Registered under section 25 of the Registered Designs Ordinance**

按註冊編號排列

Arranged by Registration Number

### 根據註冊外觀設計條例(第 522 章)公布的其他公告

#### **Other Notices Published under the Registered Designs Ordinance (Cap. 522)**

根據註冊外觀設計條例第 28 條, 註冊外觀設計因未繳續期費而停止有效

Registered designs ceased through non-payment of renewal fees under section 28 of the Registered Designs Ordinance

根據註冊外觀設計規則第 31 條刪除的註冊外觀設計

Registered designs removed under section 31 of the Registered Designs Rules

### 以下事項沒有記錄

#### **No Records for the Following Matters**

根據註冊外觀設計條例第 30 條放棄的外觀設計的註冊

Surrender of Registration of Design under section 30 of the Registered Designs Ordinance

根據註冊外觀設計規則第 37 條, 向處長作出轉介

Reference to Registrar under section 37 of the Registered Designs Rules

根據註冊外觀設計條例第 45 條, 撤銷註冊

Revocation of Registration under section 45 of the Registered Designs Ordinance

根據註冊外觀設計規則第 46 條，向法院作出轉介

Reference to Court under section 46 of the Registered Designs Rules

根據註冊外觀設計規則第 63 條對不符合規定之處作出糾正

Rectification of Irregularities under section 63 of the Registered Designs Rules

根據註冊外觀設計條例第 66 條，糾正註冊紀錄冊

Rectification of Register under section 66 of the Registered Designs Ordinance

根據註冊外觀設計條例第 67 條 更正註冊紀錄冊內的錯誤

Correction of errors in Register under section 67 of the Registered Designs Ordinance

根據註冊外觀設計條例第 67 及 76 條，更正註冊紀錄冊內及已提交文件中的錯誤

Correction of Errors in Register and in Filed Documents under sections 67 and 76 of the Registered Designs Ordinance

根據註冊外觀設計條例第 76 條，更正已提交文件中的錯誤

Correction of errors in filed documents under section 76 of the Registered Designs Ordinance

勘誤

Corrigendum

## 註冊外觀設計公告註釋

### Notes on advertisements of registration of designs

方括號表示下列資料：

Square brackets indicate the following data：

[11] 註冊編號 Registration number / 聯合王國註冊編號 United Kingdom registration number

[15] 註冊日期 Registration date / 當作註冊日期 Deemed registration date / 聯合王國註冊日期 United Kingdom registration date

[17] 註冊有效期屆滿日期 Expiry date of the period of registration

[22] 提交日期 Filing date / 當作提交日期 Deemed filing date / 聯合王國提交日期 United Kingdom filing date

[30] 聲稱享有的優先權（提交日期 / 巴黎公約國或世界貿易組織成員 / 申請編號） Priority claimed (filing date / Paris Convention country or WTO member / application number)

[51] 國際外觀設計分類號（洛迦諾分類號） International Classification of designs (Locarno Classification)

[54] 物品 Article

[55] 外觀設計的表述 Representation of the design

[62] 分開前的申請編號及提交日期 Application number before division and filing date

[66] 過往註冊的聯繫外觀設計註冊編號 / 日期 Registration No. / Date of Previous Registration for Association

[72] 設計人 Designer

[73] 擁有人姓名和地址 Name and address of the owner

[74] 代理人 Agent /送達地址 Address for service



香港特別行政區政府知識產權署外觀設計註冊處  
The Government of the Hong Kong Special Administrative Region  
Designs Registry, Intellectual Property Department

## 根據註冊外觀設計條例第 25 條註冊的外觀設計

### Designs registered under section 25 of the Registered Designs Ordinance

按註冊編號排列

Arranged by Registration Number

- [11] 1913124.8M001
- [15] 04-03-2019
- [30] 28-12-2018 / JP / 2018 of 028871
- [51] Cl. 16-06
- [54] 眼鏡架  
Glasses frame
- [73] Hazuki Company Kabushiki Kaisha  
10-1, Roppongi 6 chome  
Minato-ku  
Tokyo  
JAPAN
- [74] DEACONS  
5th Floor, Alexandra House  
Central  
HONG KONG



- 
- [11] 1913124.8M002
  - [15] 04-03-2019
  - [30] 28-12-2018 / JP / 2018 of 028872
  - [51] Cl. 16-06
  - [54] 眼鏡架  
Glasses frame

[73] Hazuki Company Kabushiki Kaisha  
10-1, Roppongi 6 chome  
Minato-ku  
Tokyo  
JAPAN

[74] DEACONS  
5th Floor, Alexandra House  
Central  
HONG KONG



---

[11] 1914203.7M001

[15] 11-07-2019

[51] Cl. 3-01

[54] 盛載唇膏、眼部化妝品、香水、粉底等化妝物品之螺子形狀器皿  
Shell shape containers for lip-makeup, eye-make up, perfume,  
makeup foundation

[73] 魏素娟  
Ngai So-Kuen Connie  
香港大坑  
浣紗街 25 號  
龍濤苑 2 座 29 樓 E 室

[74] 魏素娟  
香港大坑  
浣紗街 25 號  
龍濤苑 2 座 29 樓 E 室

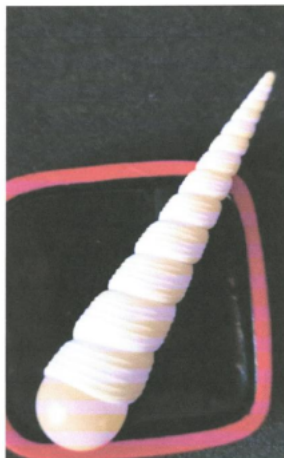

[11] 1914203.7M002

[15] 11-07-2019

[51] Cl. 3-01

[54] 盛載唇膏、眼部化妝品、香水、粉底等化妝物品之螺子形狀器皿  
Shell shape containers for lip-make up, eye-make up, perfume,  
makeup foundation

[73] 魏素娟  
Ngai So-Kuen Connie  
香港大坑  
浣紗街 25 號  
龍濤苑 2 座 29 樓 E 室

[74] 魏素娟  
香港大坑  
浣紗街 25 號  
龍濤苑 2 座 29 樓 E 室





- [11] 1914237.9  
[15] 16-07-2019  
[51] Cl. 25-01  
[54] 擋音式減音窗  
Baffle type acoustics window  
[73] 建築聲學有限公司  
Architectural Acoustics Ltd  
香港尖沙咀  
寶勒巷 29 號寶昌商業大廈  
2 樓  
[74] 建築聲學有限公司  
香港  
尖沙咀寶勒巷 29 號  
寶昌商業大廈  
二樓

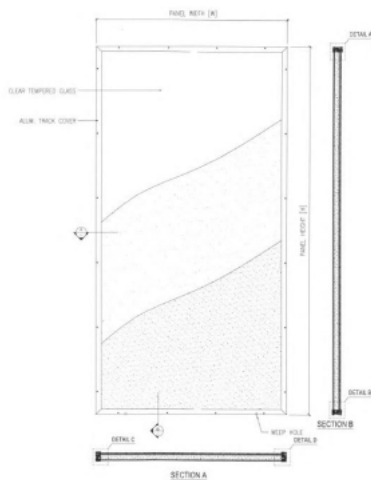

- [11] 1914247.0  
[15] 16-07-2019  
[30] 17-01-2019 / EU / 006049508-0014  
[51] Cl. 11-01  
[54] 首飾  
Jewellery  
[73] LOUIS VUITTON MALLETIER  
2 rue du Pont-Neuf  
75001 Paris  
FRANCE  
[74] BAKER & MCKENZIE  
14TH FLOOR, ONE TAIKOO PLACE,

979 KING'S ROAD, QUARRY BAY,  
HONG KONG

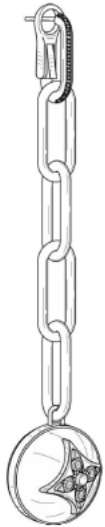

[11] 1914255.7

[15] 16-07-2019

[30] 17-01-2019 / EU / 006049508-0006

[51] Cl. 11-01

[54] 首飾

Jewellery

[73] LOUIS VUITTON MALLETIER

2 rue du Pont-Neuf

75001 Paris

FRANCE

[74] BAKER & MCKENZIE

14TH FLOOR, ONE TAIKOO PLACE,

979 KING'S ROAD, QUARRY BAY,

HONG KONG



- [11] 1914257.1  
[15] 16-07-2019  
[30] 17-01-2019 / EU / 006049508-0004  
[51] Cl. 11-01  
[54] 首飾  
Jewellery  
[73] LOUIS VUITTON MALLETIER  
2 rue du Pont-Neuf  
75001 Paris  
FRANCE  
[74] BAKER & MCKENZIE  
14TH FLOOR, ONE TAIKOO PLACE,  
979 KING'S ROAD, QUARRY BAY,  
HONG KONG

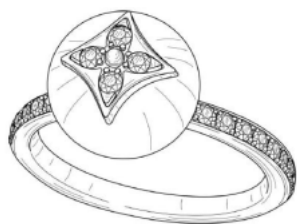

- 
- [11] 1914513.5  
[15] 22-08-2019  
[51] Cl. 10-07  
[54] 酒精測試器  
Alcohol Tester  
[73] 冠一產品製造有限公司  
A&A Product Manufacturing Limited  
香港新界沙田石門安平街  
06 號新貿中心 A 座  
18 樓 09 室  
[74] 冠一產品製造有限公司  
香港新界沙田石門安平街  
06 號新貿中心 A 座  
18 樓 09 室

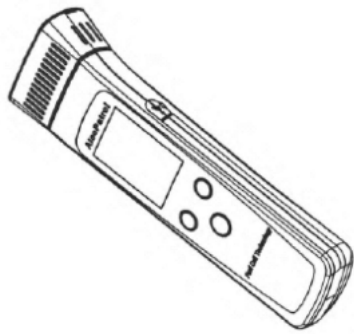

---

[11] 1914533.7

[15] 26-08-2019

[30] 01-03-2019 / EU / 006272258-0001

[51] Cl. 27-05

[54] 氣體打火機

Gas lighter

[73] FLAMAGAS, S.A.

Metalúrgia, 38-42

08038 BARCELONA

SPAIN

[74] UNITALEN ATTORNEYS AT LAW LIMITED

RM 1201, 12/F,

GOLDEN ERA PLAZA,

39-55 SAI YEE ST, MONGKOK KLN

HONG KONG



---

[11] 1914541.4

[15] 27-08-2019

[51] Cl. 14-01

[54] 藍芽耳機  
Bluetooth headset

[73] 高崎國際控股有限公司  
GOKI INTERNATIONAL HOLDING COMPANY LIMITED  
香港九龍官塘  
偉業街 139-141 號  
兆發工業大廈 14 樓 7 室

[74] 高崎國際控股有限公司  
香港  
九龍官塘偉業街 139-141 號  
兆發工業大廈 14 樓 7 室

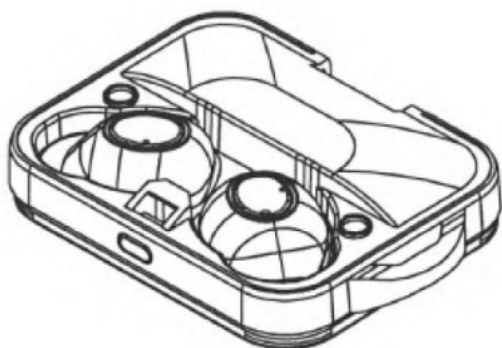

---

[11] 1914787.5M001

[15] 09-10-2019

[51] Cl. 2-04

[54] 鞋底  
Shoe sole

[73] Airwair International Limited  
Cobb's Lane, Wollaston, Wellingborough,  
Northamptonshire NN29 7SW  
UNITED KINGDOM

[74] MARKS & CLERK  
Level 9, Cyberport 1  
100 Cyberport Road, Pok Fu Lam  
HONG KONG



---

[11] 1914787.5M002

[15] 09-10-2019

[51] Cl. 2-04

[54] 鞋  
Shoe

[73] Airwair International Limited  
Cobb's Lane, Wollaston, Wellingborough,  
Northamptonshire NN29 7SW  
UNITED KINGDOM

[74] MARKS & CLERK  
Level 9, Cyberport 1  
100 Cyberport Road, Pok Fu Lam  
HONG KONG



---

[11] 1914788.7

[15] 09-10-2019

[30] 17-09-2019 / US / 29/706,023  
17-09-2019 / US / 29/706,023

[51] Cl. 21-01

[54] 玩具彈發射器裝置  
Toy Projectile Launcher Apparatus

[73] HASBRO, INC.  
1027 Newport Avenue,  
Pawtucket, Rhode Island 02862-1059  
UNITED STATES

[74] BIRD & BIRD  
4/F Three Pacific Place  
1 Queen's Road East  
HONG KONG

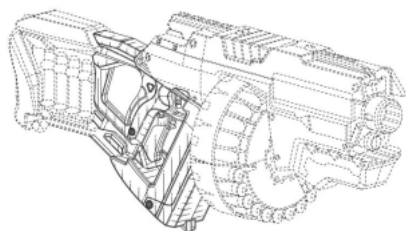

---

[11] 1914789.9

[15] 09-10-2019

[30] 17-09-2019 / US / 29/706,027

[51] Cl. 21-01

[54] 玩具彈發射器裝置  
Toy projectile launcher apparatus

[73] HASBRO, INC.  
1027 Newport Avenue,  
Pawtucket, Rhode Island 02862-1059  
UNITED STATES

[74] BIRD & BIRD  
4/F Three Pacific Place  
1 Queen's Road East  
HONG KONG

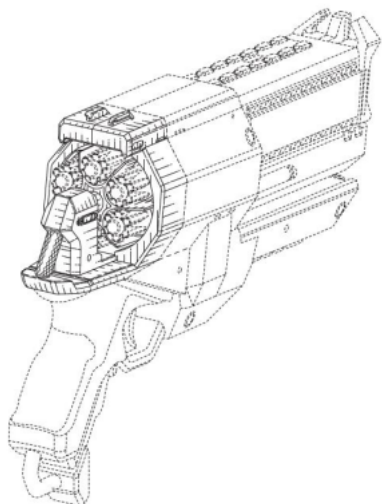

[11] 1914790.1

[15] 09-10-2019

[30] 09-05-2019 / CA, AM, AZ, BZ, BA, GE, LI, MK, MD, MC, MN, ME,  
MA, NO, OM, RU, SG, CH, TN, TR, UA, GB, EU, AL, KG / DM/201  
343

[51] Cl. 10-07

[54] 錶面  
Dial

[73] Harry Winston SA  
Chemin du Tourbillon 8, CH-1228 Plan-les-Ouates,  
SWITZERLAND

[74] SPRUSON & FERGUSON (HONG KONG) LIMITED  
5001 Hopewell Centre  
183 Queen's Road East, Wan Chai  
HONG KONG

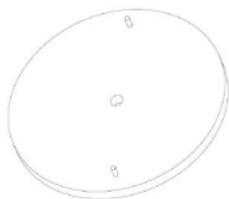



[11] 1914791.3

[15] 09-10-2019

[30] 18-04-2019 / KR / 30-2019-0018361

[51] Cl. 28-03

[54] 用於皮膚護理的 LED 面罩

LED face mask for skin care

[73] Pamtek COSMETIC Co., LTD.

9F, Saimdang-ro 26, Seocho-gu, Seoul

REPUBLIC OF KOREA

[74] C&H IP LAW LIMITED

1206, Eastern Commercial Centre, 397 Hennessy Road, Wan Chai

HONG KONG

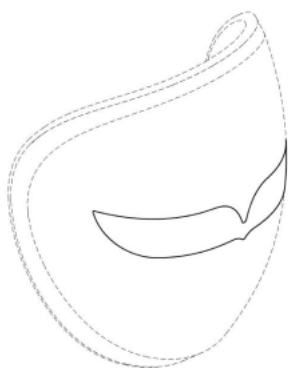

---

[11] 1914793.7

[15] 09-10-2019

[30] 18-04-2019 / KR / 30-2019-0018350

[51] Cl. 28-03

[54] 用於皮膚護理的 LED 面罩

LED face mask for skin care

[73] Pamtek COSMETIC Co., LTD.

9F, Saimdang-ro 26, Seocho-gu, Seoul

REPUBLIC OF KOREA

[74] C&H IP LAW LIMITED

1206, Eastern Commercial Centre, 397 Hennessy Road, Wan Chai

HONG KONG

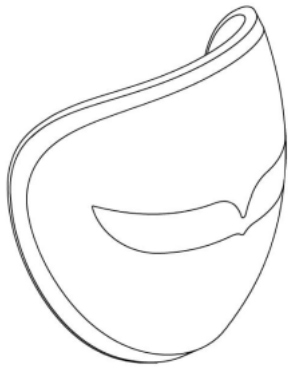

---

[11] 1914795.2

[15] 09-10-2019

[30] 07-09-2019 / CN / 201930492871.3

[51] Cl. 13-03

[54] 插頭

Electrical plug

[73] 東莞市佳旅電器有限公司

Dongguan Best Travel Electronics Co.,Ltd.

中國內地

廣東省東莞市長安鎮上角社區銅古中路 6 號

B 棟四樓 402

[74] 旻貝國際知識產權代理有限公司

香港

新界白石角香港科學園

第三期科技大道西 12 號 2 樓 230 室

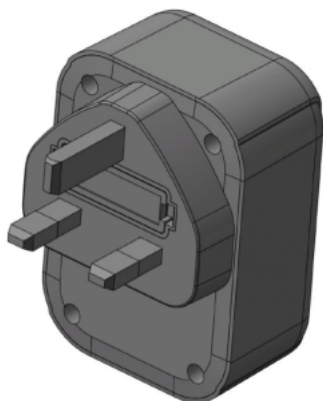

---

[11] 1914801.6M001

[15] 10-10-2019

[30] 10-04-2019 / US / 29/687,141

[51] Cl. 14-04

[54] 用於顯示幕或其一部分的圖形化使用者介面

Graphical user interface for display screen or portion thereof

[73] DISNEY ENTERPRISES, INC.

500 SOUTH BUENA VISTA STREET

BURBANK, CALIFORNIA 91521

UNITED STATES

[74] BARRON & YOUNG INTELLECTUAL PROPERTY LIMITED

Suite 617, Lakeside 2

No. 10 Science Park West Avenue, Hong Kong Science Park,

Shatin, N.T.

HONG KONG

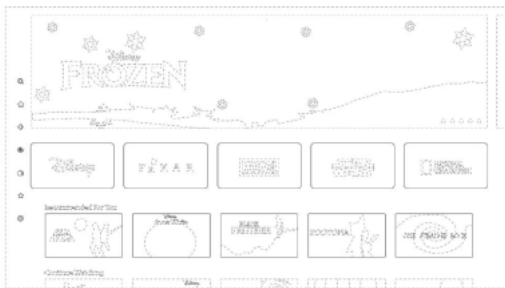

[11] 1914801.6M002

[15] 10-10-2019

[30] 10-04-2019 / US / 29/687,141

[51] Cl. 14-04

[54] 用於顯示幕或其一部分的圖形化使用者介面

Graphical user interface for display screen or portion thereof

[73] DISNEY ENTERPRISES, INC.

500 SOUTH BUENA VISTA STREET

BURBANK, CALIFORNIA 91521

UNITED STATES

[74] BARRON & YOUNG INTELLECTUAL PROPERTY LIMITED

Suite 617, Lakeside 2

No. 10 Science Park West Avenue, Hong Kong Science Park,

Shatin, N.T.

HONG KONG

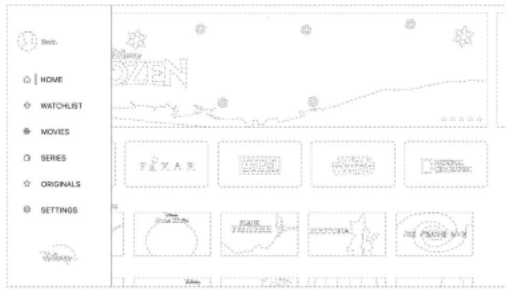

[11] 1914801.6M003

[15] 10-10-2019

[30] 11-09-2019 / US / 29/705,408

[51] Cl. 14-04

[54] 用於顯示幕或其一部分的圖形化使用者介面

Graphical user interface for display screen or portion thereof

[73] DISNEY ENTERPRISES, INC.

500 SOUTH BUENA VISTA STREET

BURBANK, CALIFORNIA 91521

UNITED STATES

[74] BARRON & YOUNG INTELLECTUAL PROPERTY LIMITED

Suite 617, Lakeside 2

No. 10 Science Park West Avenue, Hong Kong Science Park,

Shatin, N.T.

HONG KONG

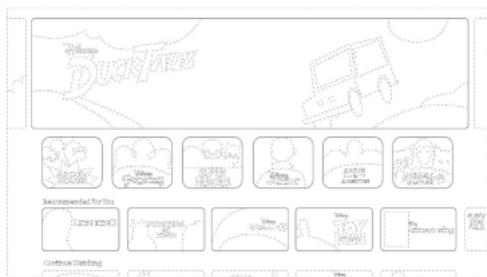

[11] 1914801.6M004

[15] 10-10-2019

[30] 11-09-2019 / US / 29/705,408

[51] Cl. 14-04

[54] 用於顯示幕或其一部分的圖形化使用者介面

Graphical user interface for display screen or portion thereof

[73] DISNEY ENTERPRISES, INC.

500 SOUTH BUENA VISTA STREET

BURBANK, CALIFORNIA 91521  
UNITED STATES

- [74] BARRON & YOUNG INTELLECTUAL PROPERTY LIMITED  
Suite 617, Lakeside 2  
No. 10 Science Park West Avenue, Hong Kong Science Park,  
Shatin, N.T.  
HONG KONG

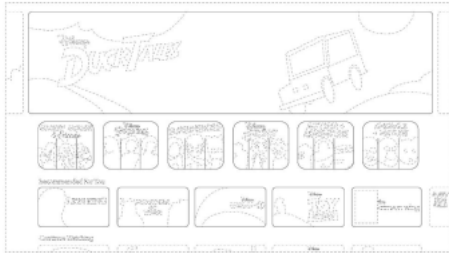

- 
- [11] 1914801.6M005  
[15] 10-10-2019  
[30] 11-09-2019 / US / 29/705,408  
[51] Cl. 14-04  
[54] 用於顯示幕或其一部分的圖形化使用者介面  
Graphical user interface for display screen or portion thereof  
[73] DISNEY ENTERPRISES, INC.  
500 SOUTH BUENA VISTA STREET  
BURBANK, CALIFORNIA 91521  
UNITED STATES  
[74] BARRON & YOUNG INTELLECTUAL PROPERTY LIMITED  
Suite 617, Lakeside 2  
No. 10 Science Park West Avenue, Hong Kong Science Park,  
Shatin, N.T.  
HONG KONG

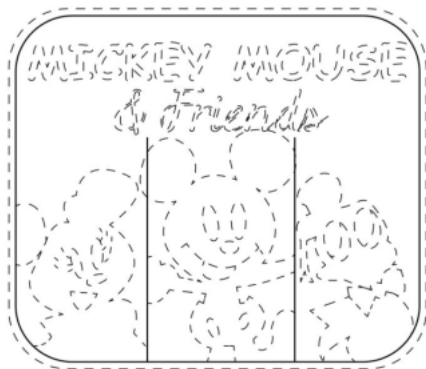

- [11] 1914801.6M006
- [15] 10-10-2019
- [30] 11-09-2019 / US / 29/705,408
- [51] Cl. 14-04
- [54] 用於顯示幕或其一部分的圖形化使用者介面  
Graphical user interface for display screen or portion thereof
- [73] DISNEY ENTERPRISES, INC.  
500 SOUTH BUENA VISTA STREET  
BURBANK, CALIFORNIA 91521  
UNITED STATES
- [74] BARRON & YOUNG INTELLECTUAL PROPERTY LIMITED  
Suite 617, Lakeside 2  
No. 10 Science Park West Avenue, Hong Kong Science Park,  
Shatin, N.T.  
HONG KONG

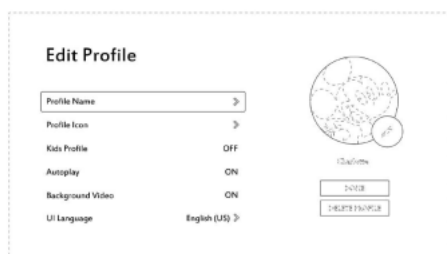

- 
- [11] 1914802.8M001
- [15] 10-10-2019
- [30] 12-04-2019 / JP / JP 2019-008037
- [51] Cl. 9-05
- [54] 包裝袋  
Sachet
- [73] 株式會社大塚製藥工場  
Otsuka Pharmaceutical Factory, Inc.  
115 Kuguhara, Tateiwa, Muya-cho  
Naruto, Tokushima 772-8601  
JAPAN
- [74] WILKINSON & GRIST  
6th Floor, Prince's Building  
Chater Road  
HONG KONG

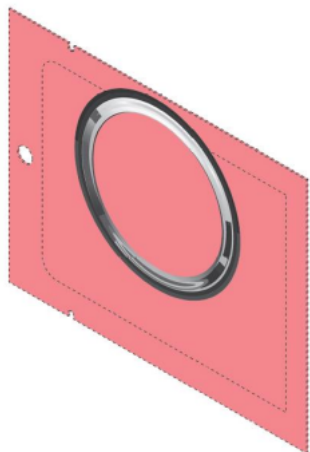

[11] 1914802.8M002

[15] 10-10-2019

[30] 12-04-2019 / JP / JP 2019-008036

[51] Cl. 9-03

[54] 包裝盒

Packaging Box

[73] 株式會社大塚製藥工場

Otsuka Pharmaceutical Factory, Inc.

115 Kuguhara, Tateiwa, Muya-cho

Naruto, Tokushima 772-8601

JAPAN

[74] WILKINSON & GRIST

6th Floor, Prince's Building

Chater Road

HONG KONG



- [11] 1914802.8M003  
[15] 10-10-2019  
[30] 12-04-2019 / JP / JP 2019-008038  
[51] Cl. 9-03  
[54] 包裝罐  
Packaging Can  
[73] 株式會社大塚製藥工場  
Otsuka Pharmaceutical Factory, Inc.  
115 Kuguhara, Tateiwa, Muya-cho  
Naruto, Tokushima 772-8601  
JAPAN  
[74] WILKINSON & GRIST  
6th Floor, Prince's Building  
Chater Road  
HONG KONG



- 
- [11] 1914804.2  
[15] 11-10-2019  
[51] Cl. 9-01  
[54] 瓶  
Bottle  
[73] SUNTORY HOLDINGS LIMITED  
1-40, DOJIMAHAMA 2-CHOME,  
KITA-KU, OSAKA-SHI, OSAKA 530-8203  
JAPAN  
[74] CHINA PATENT AGENT (HONG KONG) LIMITED  
22/F, Great Eagle Centre, 23 Harbour Road,  
Wanchai  
HONG KONG





---

[11] 1914805.5

[15] 11-10-2019

[51] Cl. 9-01

[54] 瓶

Bottle

[73] SUNTORY HOLDINGS LIMITED

1-40, DOJIMAHAMA 2-CHOME, KITA-KU

OSAKA-SHI, OSAKA 530-8203

JAPAN

[74] CHINA PATENT AGENT (HONG KONG) LIMITED

22/F, Great Eagle Centre, 23 Harbour Road,

Wanchai

HONG KONG

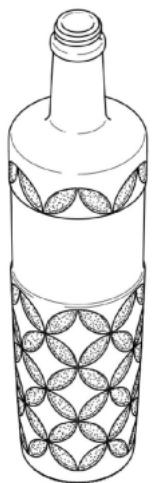

- [11] 1914806.7M001  
[15] 11-10-2019  
[30] 12-04-2019 / 70 / 006375952-0001  
[51] Cl. 12-06  
[54] 船  
Boat  
[73] DECATHLON  
4, BOULEVARD DE MONS,  
59650 VILLENEUVE  
D'ASCQ , FRANCE  
[74] WHD Ltd. (Attn to Miss Fiona Ko)  
Room 902, 9/F, Qualipak Tower  
No.121-122 Connaught Road West  
HONG KONG

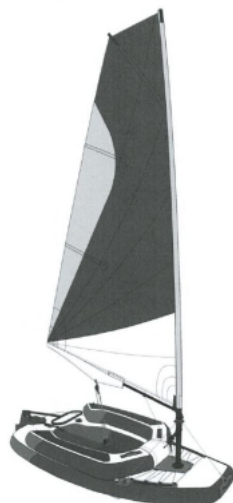

- 
- [11] 1914806.7M002  
[15] 11-10-2019  
[30] 12-04-2019 / 70 / 006375952-0002  
[51] Cl. 12-06  
[54] 船  
Boat  
[73] DECATHLON  
4, BOULEVARD DE MONS,  
59650 VILLENEUVE  
D'ASCQ , FRANCE  
[74] WHD Ltd. (Attn to Miss Fiona Ko)  
Room 902, 9/F, Qualipak Tower  
No.121-122 Connaught Road West  
HONG KONG



---

[11] 1914806.7M003

[15] 11-10-2019

[30] 12-04-2019 / 70 / 006375952-0003

[51] Cl. 12-06

[54] 船

Boat

[73] DECATHLON

4, BOULEVARD DE MONS,

59650 VILLENEUVE

D'ASCQ , FRANCE

[74] WHD Ltd. (Attn to Miss Fiona Ko)

Room 902, 9/F, Qualipak Tower

No.121-122 Connaught Road West

HONG KONG



[11] 1914806.7M004

[15] 11-10-2019

[30] 12-04-2019 / 70 / 006375952-0004

[51] Cl. 12-06

[54] 船體

Boat hull

[73] DECATHLON

4, BOULEVARD DE MONS,

59650 VILLENEUVE

D'ASCQ , FRANCE

[74] WHD Ltd. (Attn to Miss Fiona Ko)

Room 902, 9/F, Qualipak Tower

No.121-122 Connaught Road West

HONG KONG



---

[11] 1914806.7M005

[15] 11-10-2019

[30] 12-04-2019 / 70 / 006375952-0005

[51] Cl. 12-06

[54] 船體

Boat hull

[73] DECATHLON

4, BOULEVARD DE MONS,

59650 VILLENEUVE

D'ASCQ , FRANCE

[74] WHD Ltd. (Attn to Miss Fiona Ko)

Room 902, 9/F, Qualipak Tower

No.121-122 Connaught Road West

HONG KONG

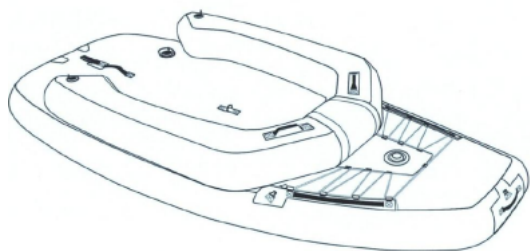

---

[11] 1914806.7M006

[15] 11-10-2019

[30] 12-04-2019 / 70 / 006375952-0006

[51] Cl. 12-06

[54] 船體

Boat hull

[73] DECATHLON

4, BOULEVARD DE MONS,

59650 VILLENEUVE

D'ASCQ , FRANCE

[74] WHD Ltd. (Attn to Miss Fiona Ko)

Room 902, 9/F, Qualipak Tower

No.121-122 Connaught Road West

HONG KONG



---

[11] 1914807.9

[15] 11-10-2019

[51] Cl. 14-01

[54] 耳機

Headphone

[73] 鄭明勳  
中國內地  
吉林省延吉市進學街  
嬌陽委三十三組

[74] 滙誠知識產權有限公司  
香港  
灣仔軒尼詩道 397 號東區商業大廈 1206 室



---

[11] 1914809.3M001

[15] 11-10-2019

[30] 22-04-2019 / JP / 2019-008944

[51] Cl. 23-03

[54] 取暖器  
Heater

[73] Iris Ohyama Inc.  
2-12-1, Itsutsubashi, Aoba-ku,  
Sendai-shi, Miyagi, 980-8510,  
JAPAN

[74] Emily Yip & Co Limited  
1st Floor, Kingsfield Centre  
18 Shell Street, Fortress Hill  
HONG KONG

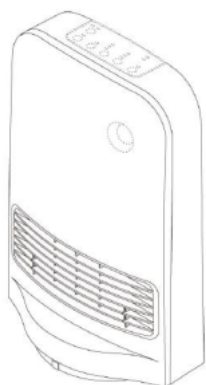

---

[11] 1914809.3M002

[15] 11-10-2019

[30] 19-06-2019 / JP / 2019-013473

[51] Cl. 23-03

[54] 取暖器  
Heater

[73] Iris Ohyama Inc.  
2-12-1, Itsutsubashi, Aoba-ku,  
Sendai-shi, Miyagi, 980-8510,  
JAPAN

[74] Emily Yip & Co Limited  
1st Floor, Kingsfield Centre  
18 Shell Street, Fortress Hill  
HONG KONG

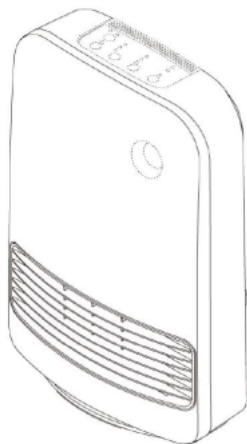

- [11] 1914811.7  
[15] 14-10-2019  
[30] 14-04-2019 / US / 29/687,590  
[51] Cl. 20-01  
[54] 飲水機  
Water dispenser  
[73] S.B.I.D SOLUTIONS, ENTERPRISE AND INVESTMENTS LTD.  
9 HASHAYETET STREET, APT. 8  
7876800 ASHKELON  
ISRAEL  
[74] CHINA PATENT AGENT (HONG KONG) LIMITED  
22/F, Great Eagle Centre, 23 Harbour Road,  
Wanchai  
HONG KONG

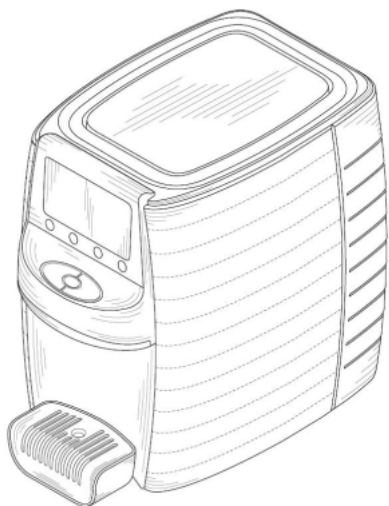

- 
- [11] 1914812.9  
[15] 14-10-2019  
[30] 18-04-2019 / CA, EG, MA, NO, RU, SG, CH, TN, TR, UA, GB, US,  
EU, JP, KR / WIPO82769  
[51] Cl. 9-01  
[54] 香水樽  
Perfume bottle  
[73] COMPTOIR NOUVEAU DE LA PARFUMERIE  
23 rue Boissy d'Anglas  
F-75008 PARIS  
FRANCE  
[74] DEACONS  
5th Floor, Alexandra House  
Central  
HONG KONG





---

[11] 1914813.1

[15] 14-10-2019

[30] 15-04-2019 / KR / 30-2019-0017497

[51] Cl. 24-01

[54] 皮膚護理器

Skin treatment apparatus

[73] LG ELECTRONICS INC.

128, Yeoui-daero,

Yeongdeungpo-gu

Seoul

REPUBLIC OF KOREA

[74] NORTON ROSE FULBRIGHT HONG KONG

38/F Jardine House, 1 Connaught Place

Central

HONG KONG

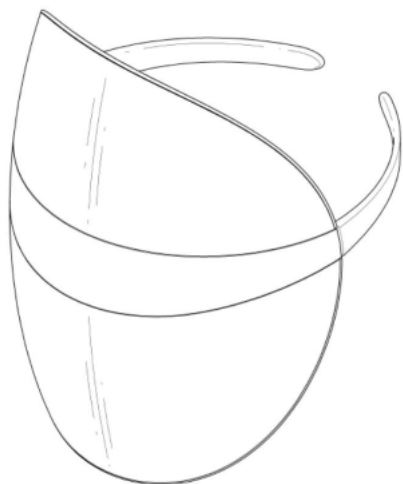

- [11] 1914814.3  
[15] 14-10-2019  
[30] 15-04-2019 / CN / 201930169463.4  
[51] Cl. 7-02  
[54] 湯勺  
Soup spoon  
[73] 北京小米移動軟件有限公司  
BEIJING XIAOMI MOBILE SOFTWARE CO., LTD.  
中國內地  
北京市清河中街 68 號  
華潤五彩城購物中心二期 9 層 01 房間  
[74] 香港派特恩知識產權代理有限公司  
香港  
上環永樂街 121-125 號  
永達商業大廈 10 樓 C 室



- 
- [11] 1914817.0  
[15] 14-10-2019  
[30] 15-04-2019 / CN / 201930169420.6  
[51] Cl. 10-04  
[54] 量杯  
Measuring cup  
[73] 北京小米移動軟件有限公司  
BEIJING XIAOMI MOBILE SOFTWARE CO., LTD.  
中國內地  
北京市清河中街 68 號  
華潤五彩城購物中心二期 9 層 01 房間

- [74] 香港派特恩知識產權代理有限公司  
香港  
上環永樂街 121-125 號  
永達商業大廈 10 樓 C 室

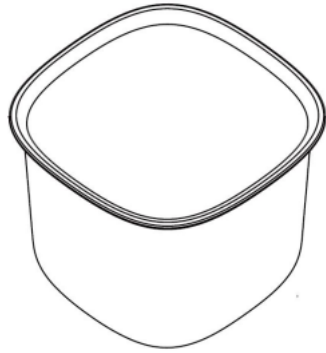

- 
- [11] 1914821.8  
[15] 15-10-2019  
[30] 19-04-2019 / KR / 30-2019-0018631  
[51] Cl. 27-07  
[54] 電子煙  
Electronic cigarette  
[73] KT&G Corporation  
71, Beotkkot-gil,  
Daedeok-gu, Daejeon  
Republic of Korea  
[74] Luo & Jia Intellectual Property Limited  
9B, Cheong Tai Commercial Building,  
66 Wing Lok Street, Sheung Wan,  
Hong Kong



---

[11] 1914823.2

[15] 15-10-2019

[30] 19-04-2019 / KR / 30-2019-0018627

[51] Cl. 27-07

[54] 電子煙

Electronic cigarette

[73] KT & G Corporation

71, Beotkkot-gil,

Daedeok-gu, Daejeon

Republic of Korea

[74] Luo & Jia Intellectual Property Limited

9B, Cheong Tai Commercial Building,

66 Wing Lok Street, Sheung Wan,

Hong Kong



- [11] 1914826.9  
[15] 15-10-2019  
[51] Cl. 9-03  
[54] 環保包裝盒  
Environmental friendly packing box  
[73] INNOVHK LIMITED  
香港  
新界沙田安耀街 3 號  
匯達大廈 9 樓 911-915 室  
[74] 天標知識產權代理有限公司  
香港  
九龍尖沙咀加連威老道 14 號  
加連威大廈 4 樓 A 座



- 
- [11] 1914827.1  
[15] 16-10-2019  
[30] 09-05-2019 / EU / 006436036-0001  
[51] Cl. 7-01  
[54] 飲料杯蓋  
Lid for drinking cups  
[73] 恒豐國際實業有限公司  
HANG FUNG INTERNATIONAL INDUSTRIAL CO., LTD.  
Unit 13, 8/F Harbour Centre, Tower 1,  
1 Hok Cheung Street, Hunghom, Kowloon  
HONG KONG  
[74] UNION PATENT SERVICE CENTRE  
Units E-F, 20th Floor, Neich Tower,  
128 Gloucester Road,  
HONG KONG

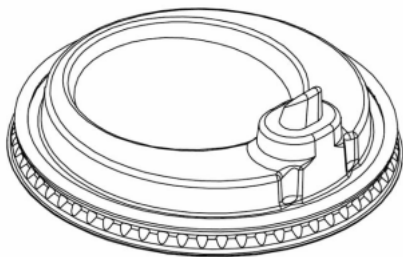

[11] 1914829.5

[15] 17-10-2019

[30] 04-09-2019 / CN / 201930486790.2

[51] C1. 3-04

[54] 風扇

Fan

[73] 深圳市同創創精密電子有限公司

中國內地

深圳市寶安區西鄉街道三圍華豐第一科技園

B區一棟三樓、八樓北

[74] 金信智權有限公司

香港

觀塘偉業街 221 號

美德工業大廈 D 座 10/F 38 室



- [11] 1914830.7  
[15] 17-10-2019  
[30] 02-08-2019 / CN / 201930418768.4  
[51] Cl. 23-04  
[54] 加濕器  
Humidifier  
[73] 深圳市同創創精密電子有限公司  
中國內地  
深圳市寶安區西鄉街道三圍華豐第一科技園  
B 區一棟三樓、八樓北  
[74] 金信智權有限公司  
香港  
觀塘偉業街 221 號  
美德工業大廈 D 座 10/F 38 室



- 
- [11] 1914831.9M001  
[15] 17-10-2019  
[51] Cl. 3-01  
[54] 行李箱  
Luggage  
[73] 新秀麗 IP 控股有限責任公司  
Samsonite IP Holdings S.à r.l.  
13-15 avenue de la Liberté  
L-1931 Luxembourg  
LUXEMBOURG  
[74] WILKINSON & GRIST  
6th Floor, Prince's Building  
Chater Road  
HONG KONG

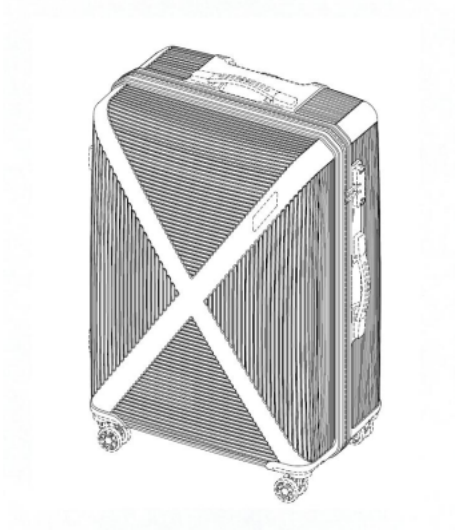

---

[11] 1914831.9M002

[15] 17-10-2019

[51] Cl. 3-01

[54] 行李箱

Luggage

[73] 新秀麗 IP 控股有限責任公司

Samsonite IP Holdings S.à r.l.

13-15 avenue de la Liberté

L-1931 Luxembourg

LUXEMBOURG

[74] WILKINSON & GRIST

6th Floor, Prince's Building

Chater Road

HONG KONG





[11] 1914831.9M003

[15] 17-10-2019

[51] Cl. 3-01

[54] 行李箱

Luggage

[73] 新秀麗 IP 控股有限責任公司

Samsonite IP Holdings S.à r.l.

13-15 avenue de la Liberté

L-1931 Luxembourg

LUXEMBOURG

[74] WILKINSON & GRIST

6th Floor, Prince's Building

Chater Road

HONG KONG

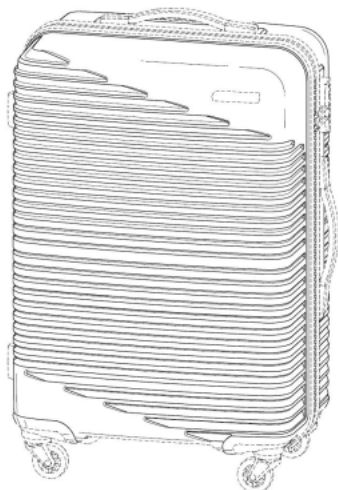

---

[11] 1914831.9M004

[15] 17-10-2019

[51] Cl. 3-01

[54] 行李箱

Luggage

[73] 新秀麗 IP 控股有限責任公司

Samsonite IP Holdings S.à r.l.

13-15 avenue de la Liberté

L-1931 Luxembourg

LUXEMBOURG

[74] WILKINSON & GRIST

6th Floor, Prince's Building

Chater Road

HONG KONG



---

[11] 1914831.9M005

[15] 17-10-2019

[51] Cl. 3-01

[54] 行李箱

Luggage

[73] 新秀麗 IP 控股有限責任公司

Samsonite IP Holdings S.à r.l.

13-15 avenue de la Liberté

L-1931 Luxembourg

LUXEMBOURG

[74] WILKINSON & GRIST

6th Floor, Prince's Building

Chater Road

HONG KONG

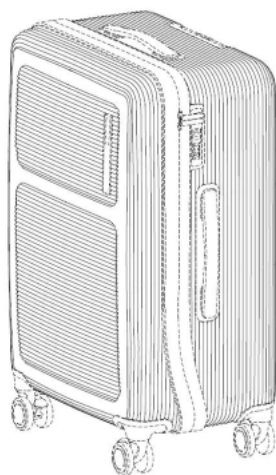

- [11] 1914832.1M001  
[15] 17-10-2019  
[30] 23-04-2019 / CN / 201930188579.2  
[51] C1. 14-01  
[54] 音箱  
Speaker  
[73] BEIJING XIAOMI MOBILE SOFTWARE CO., LTD.  
北京小米移動軟件有限公司  
中國內地  
北京市清河中街 68 號  
華潤五彩城購物中心二期 9 層 01 房間  
[74] 香港派特恩知識產權代理有限公司  
香港  
上環永樂街 121-125 號  
永達商業大廈 10 樓 C 室

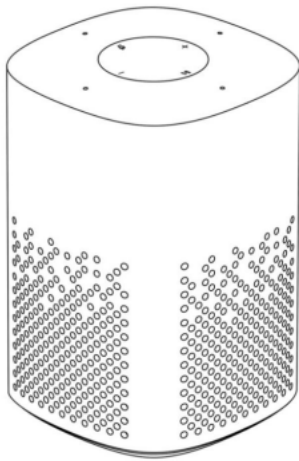

- 
- [11] 1914832.1M002  
[15] 17-10-2019  
[30] 23-04-2019 / CN / 201930188579.2  
[51] C1. 14-01  
[54] 音箱  
Speaker  
[73] BEIJING XIAOMI MOBILE SOFTWARE CO., LTD.  
北京小米移動軟件有限公司  
中國內地  
北京市清河中街 68 號  
華潤五彩城購物中心二期 9 層 01 房間

- [74] 香港派特恩知識產權代理有限公司  
香港  
上環永樂街 121-125 號  
永達商業大廈 10 樓 C 室

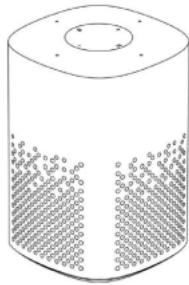

- 
- [11] 1914833.3M001  
[15] 17-10-2019  
[51] Cl. 23-04  
[54] 香薰機  
Aroma diffuser  
[73] Bloomy Lotus Ltd  
Unit 4711, 47/F., The Center,  
99 Queen's Road Central, Central,  
HONG KONG  
[74] FEDERATION OF HONG KONG INDUSTRIES  
31/F, Billion Plaza,  
8 Cheung Yue Street, Cheung Sha Wan, Kowloon  
HONG KONG

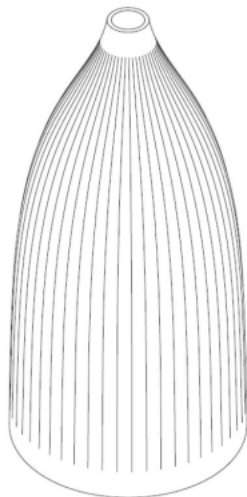

---

[11] 1914833.3M002

[15] 17-10-2019

[51] Cl. 23-04

[54] 香薰機

Aroma diffuser

[73] Bloomy Lotus Ltd

Unit 4711, 47/F., The Center,  
99 Queen's Road Central, Central,  
HONG KONG

[74] FEDERATION OF HONG KONG INDUSTRIES

31/F, Billion Plaza,  
8 Cheung Yue Street, Cheung Sha Wan, Kowloon  
HONG KONG

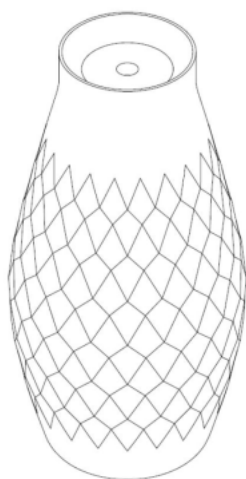

[11] 1914833.3M003

[15] 17-10-2019

[51] Cl. 23-04

[54] 香薰機

Aroma diffuser

[73] Bloomy Lotus Ltd

Unit 4711, 47/F., The Center,  
99 Queen's Road Central, Central,  
HONG KONG

[74] FEDERATION OF HONG KONG INDUSTRIES

31/F, Billion Plaza,  
8 Cheung Yue Street, Cheung Sha Wan, Kowloon  
HONG KONG

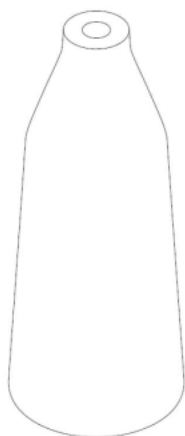

---

[11] 1914835.8

[15] 18-10-2019

[30] 07-05-2019 / CA, LI, MC, MA, RU, SG, CH, TR, GB, EU, JP, KR /  
DM/202657

[51] Cl. 9-01

[54] 香水瓶

Perfume bottle

[73] Bulgari S.p.A.

11 Lungotevere Marzio,  
00186 Rome,  
ITALY

[74] ATL LAW OFFICES

16/F., China Hong Kong Tower,  
8-12 Hennessy Road, Wanchai,  
HONG KONG



---

[11] 1914839.6M001

[15] 18-10-2019

[30] 04-09-2019 / CN / 201930485867.4

[51] Cl. 9-03

[54] 包裝盒

Package box

[73] SONY CORPORATION

1-7-1 KONAN, MINATO-KU

TOKYO 108-0075

JAPAN

[74] UNITALEN ATTORNEYS AT LAW LIMITED

RM 1201, 12/F, GOLDEN ERA PLAZA,

39-55 SAI YEE ST, MONGKOK KLN,

HONG KONG



- [11] 1914839.6M002
- [15] 18-10-2019
- [30] 04-09-2019 / CN / 201930485867.4
- [51] Cl. 9-03
- [54] 包裝盒  
Package box
- [73] SONY CORPORATION  
1-7-1 KONAN, MINATO-KU  
TOKYO 108-0075  
JAPAN
- [74] UNITALEN ATTORNEYS AT LAW LIMITED  
RM 1201, 12/F, GOLDEN ERA PLAZA,  
39-55 SAI YEE ST, MONGKOK KLN,  
HONG KONG



- 
- [11] 1914839.6M003
  - [15] 18-10-2019
  - [30] 04-09-2019 / CN / 201930485867.4
  - [51] Cl. 9-03
  - [54] 包裝盒  
Package box
  - [73] SONY CORPORATION  
1-7-1 KONAN, MINATO-KU  
TOKYO 108-0075  
JAPAN
  - [74] UNITALEN ATTORNEYS AT LAW LIMITED  
RM 1201, 12/F, GOLDEN ERA PLAZA,  
39-55 SAI YEE ST, MONGKOK KLN,  
HONG KONG





---

[11] 1914839.6M004

[15] 18-10-2019

[30] 04-09-2019 / CN / 201930485867.4

[51] Cl. 9-03

[54] 包裝盒

Package box

[73] SONY CORPORATION

1-7-1 KONAN, MINATO-KU

TOKYO 108-0075

JAPAN

[74] UNITALEN ATTORNEYS AT LAW LIMITED

RM 1201, 12/F, GOLDEN ERA PLAZA,

39-55 SAI YEE ST, MONGKOK KLN,

HONG KONG



- [11] 1914841.0  
[15] 18-10-2019  
[30] 15-08-2019 / JP / 2019-018089  
[51] Cl. 14-01  
[54] 無線耳機  
Wireless headphone  
[73] SONY CORPORATION  
1-7-1 KONAN, MINATO-KU  
TOKYO 108-0075  
JAPAN  
[74] UNITALEN ATTORNEYS AT LAW LIMITED  
RM 1201, 12/F, GOLDEN ERA PLAZA,  
39-55 SAI YEE ST, MONGKOK KLN,  
HONG KONG



- 
- [11] 1914842.2  
[15] 18-10-2019  
[30] 15-08-2019 / JP / 2019-018090  
[51] Cl. 14-01  
[54] 耳機  
Earphone  
[73] SONY CORPORATION  
1-7-1 KONAN, MINATO-KU  
TOKYO 108-0075, JAPAN  
JAPAN  
[74] UNITALEN ATTORNEYS AT LAW LIMITED  
RM 1201, 12/F, GOLDEN ERA PLAZA,  
39-55 SAI YEE ST, MONGKOK KLN,  
HONG KONG



---

[11] 1914844.6

[15] 21-10-2019

[30] 23-04-2019 / SG, CH, GB, US, EU, JP, KR / DM/202717

[51] Cl. 10-02

[54] 腕錶

Wrist-watch

[73] LA MONTRE HERMES S.A.

Erlenstrasse 31A

CH-2555 Brügg

SWITZERLAND

[74] DEACONS

5th Floor, Alexandra House

Central

HONG KONG



---

[11] 1914845.9

[15] 21-10-2019

[51] Cl. 23-04

- [54] 木紋加濕器  
Aroma diffuser wood wave
- [73] 天時電子有限公司  
Tints Development (H.K.) Ltd.  
Unit 2208, 22/F., Peninsula Tower,  
538 Castle Peak Road, Cheung Sha Wan, Kln, Hong Kong
- [74] Alvin Ho  
Unit 2208, 22/F., Peninsula Tower,  
538 Castle Peak Road, Cheung Sha Wan, Kln, HONG KONG



- 
- [11] 1914847.3M001
- [15] 21-10-2019
- [51] Cl. 11-01
- [54] 霓虹燈造型銀吊墜  
Neon sign shaped silver pendant
- [73] 《葉宣恒》以《猿創（香港）有限公司》之名營業  
香港  
中環鴨巴甸街 35 號  
元創方 B 座 H310
- [74] 猿創（香港）有限公司  
香港  
中環鴨巴甸街 35 號  
元創方 B 座 H310



---

[11] 1914847.3M002

[15] 21-10-2019

[51] Cl. 11-01

[54] 霓虹燈造型金吊墜連玉

Neon sign shaped gold pendant with jade

[73] 《葉宣恒》以《猿創（香港）有限公司》之名營業  
香港

中環鴨巴甸街 35 號

元創方 B 座 H310

[74] 猿創（香港）有限公司

香港

中環鴨巴甸街 35 號

元創方 B 座 H310



---

[11] 1914847.3M003

[15] 21-10-2019

[51] Cl. 11-01

[54] 香港景色造型銀頸鏈連水晶

Hong Kong view shaped silver necklace with crystals

[73] 《葉宣恒》以《猿創（香港）有限公司》之名營業  
香港  
中環鴨巴甸街 35 號  
元創方 B 座 H310

[74] 猿創（香港）有限公司  
香港  
中環鴨巴甸街 35 號  
元創方 B 座 H310



---

[11] 1914847.3M004

[15] 21-10-2019

[51] Cl. 11-01

[54] 香港景色造型銀手鏈連水晶  
Hong Kong view shaped silver bracelet with crystals

[73] 《葉宣恒》以《猿創（香港）有限公司》之名營業  
香港  
中環鴨巴甸街 35 號  
元創方 B 座 H310

[74] 猿創（香港）有限公司  
香港  
中環鴨巴甸街 35 號  
元創方 B 座 H310



---

[11] 1914847.3M005

[15] 21-10-2019

- [51] Cl. 11-01
- [54] 香港景色造型銀耳環連水晶  
Neon sign shaped silver pendant
- [73] 《葉宣恒》以《猿創（香港）有限公司》之名營業  
香港  
中環鴨巴甸街 35 號  
元創方 B 座 H310
- [74] 猿創（香港）有限公司  
香港  
中環鴨巴甸街 35 號  
元創方 B 座 H310



- 
- [11] 1914848.5
- [15] 21-10-2019
- [30] 22-04-2019 / KR / 30-2019-0018769
- [51] Cl. 28-03
- [54] 皮膚護理器盒子  
Case for skin treatment apparatus
- [73] LG ELECTRONICS INC.  
128, Yeoui-daero,  
Yeongdeungpo-gu  
Seoul , REPUBLIC OF KOREA
- [74] NORTON ROSE FULBRIGHT HONG KONG  
38/F Jardine House, 1 Connaught Place  
Central  
HONG KONG

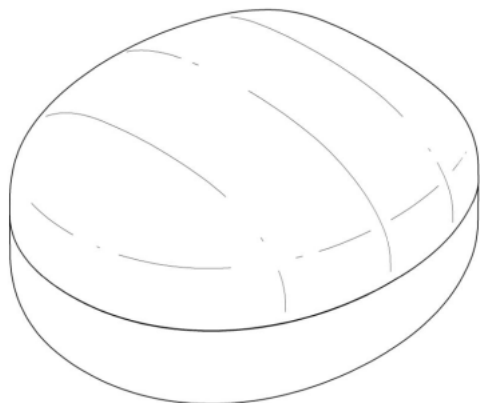

[11] 1914849.7

[15] 21-10-2019

[30] 22-04-2019 / KR / 30-2019-0018770

[51] Cl. 24-01

[54] 皮膚護理器

Skin treatment apparatus

[73] LG ELECTRONICS INC.

128, Yeoui-daero,

Yeongdeungpo-gu

Seoul, REPUBLIC OF KOREA

[74] NORTON ROSE FULBRIGHT HONG KONG

38/F Jardine House,

1 Connaught Place

Central, HONG KONG



[11] 1914850.9M001

[15] 21-10-2019

[51] Cl. 9-05



- [54] 餅乾包裝袋  
Biscuits/Crackers packing bag
- [73] FOON TAI TRADING COMPANY LIMITED  
Room 2301, 23/F., Riley House,  
88 Lei Muk Road, Kwai Chung,  
New Territories, Hong Kong
- [74] Yung, Yu, Yuen & Co., Solicitors  
11/F., Nan Fung Tower,  
88 Connaught Road Central,  
HONG KONG



- 
- [11] 1914850.9M002
- [15] 21-10-2019
- [51] Cl. 9-05
- [54] 餅乾包裝袋  
Biscuits/Crackers packing bag
- [73] FOON TAI TRADING COMPANY LIMITED  
Room 2301, 23/F., Riley House,  
88 Lei Muk Road, Kwai Chung,  
New Territories, Hong Kong
- [74] Yung, Yu, Yuen & Co., Solicitors  
11/F., Nan Fung Tower,  
88 Connaught Road Central,  
HONG KONG



---

[11] 1914850.9M003

[15] 21-10-2019

[51] Cl. 9-05

[54] 餅乾包裝袋

Biscuits/Crackers packing bag

[73] FOON TAI TRADING COMPANY LIMITED

Room 2301, 23/F., Riley House,  
88 Lei Muk Road, Kwai Chung,  
New Territories, Hong Kong

[74] Yung, Yu, Yuen & Co., Solicitors

11/F., Nan Fung Tower,  
88 Connaught Road Central,  
HONG KONG



[11] 1914850.9M004

[15] 21-10-2019

[51] Cl. 9-05

[54] 餅乾包裝袋

Biscuits/Crackers packing bag

[73] FOON TAI TRADING COMPANY LIMITED

Room 2301, 23/F., Riley House,  
88 Lei Muk Road, Kwai Chung,  
New Territories, Hong Kong

[74] Yung, Yu, Yuen & Co., Solicitors

11/F., Nan Fung Tower,  
88 Connaught Road Central,  
HONG KONG



---

[11] 1914850.9M005

[15] 21-10-2019

[51] Cl. 9-05

[54] 餅乾包裝袋

Biscuits/Crackers packing bag

[73] FOON TAI TRADING COMPANY LIMITED

Room 2301, 23/F., Riley House,  
88 Lei Muk Road, Kwai Chung,  
New Territories, Hong Kong

[74] Yung, Yu, Yuen & Co., Solicitors

11/F., Nan Fung Tower,  
88 Connaught Road Central,  
HONG KONG



[11] 1914850.9M006

[15] 21-10-2019

[51] Cl. 9-05

[54] 餅乾包裝袋

Biscuits/Crackers packing bag

[73] FOON TAI TRADING COMPANY LIMITED

Room 2301, 23/F., Riley House,  
88 Lei Muk Road, Kwai Chung,  
New Territories, Hong Kong

[74] Yung, Yu, Yuen & Co., Solicitors

11/F., Nan Fung Tower,  
88 Connaught Road Central,  
HONG KONG



[11] 1914850.9M007

[15] 21-10-2019

[51] Cl. 9-05

[54] 餅乾包裝袋

Biscuits/Crackers packing bag

[73] FOON TAI TRADING COMPANY LIMITED

Room 2301, 23/F., Riley House,

88 Lei Muk Road, Kwai Chung,

New Territories, Hong Kong

[74] Yung, Yu, Yuen & Co., Solicitors

11/F., Nan Fung Tower,

88 Connaught Road Central,

HONG KONG



---

[11] 1914852.3

[15] 22-10-2019

[51] Cl. 14-03

[54] 皮膚護理器遙控

Remote control for skin treatment apparatus

[73] LG ELECTRONICS INC.

128, Yeoui-daero,

Yeongdeungpo-gu

Seoul, REPUBLIC OF KOREA

[74] NORTON ROSE FULBRIGHT HONG KONG

38/F Jardine House,

1 Connaught Place

Central, HONG KONG

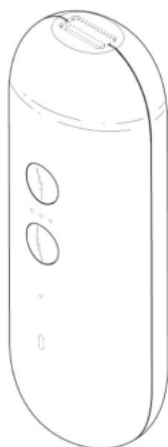

---

[11] 1914853.5

[15] 22-10-2019

[30] 26-04-2019 / KR / 30-2019-0019832

[51] Cl. 28-03

[54] 皮膚護理器座

Stand for skin treatment apparatus

[73] LG ELECTRONICS INC.

128, Yeoui-daero,

Yeongdeungpo-gu

Seoul, REPUBLIC OF KOREA

[74] NORTON ROSE FULBRIGHT HONG KONG

38/F Jardine House, 1 Connaught Place

Central

HONG KONG

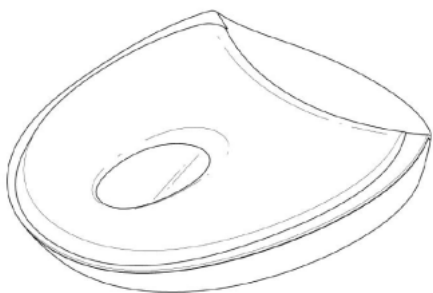

---

[11] 1914855.0

[15] 22-10-2019

[30] 16-07-2019 / TW / 108304271

[51] Cl. 6-04

[54] 藥櫃  
Medicine chest

[73] 吉鴻電子股份有限公司  
台灣  
台北市內湖區  
民權東路 6 段 15 巷 28 號

[74] 偉成國際專利商標事務所  
香港  
九龍彌敦道 430 號  
彌敦商務大廈 13 樓 A 室



---

[11] 1914856.2

[15] 22-10-2019

[30] 16-07-2019 / TW / 108304272

[51] Cl. 6-04

[54] 藥櫃  
Medicine chest

[73] 吉鴻電子股份有限公司  
台灣  
台北市內湖區  
民權東路 6 段 15 巷 28 號

[74] 偉成國際專利商標事務所  
香港  
九龍彌敦道 430 號  
彌敦商務大廈 13 樓 A 室

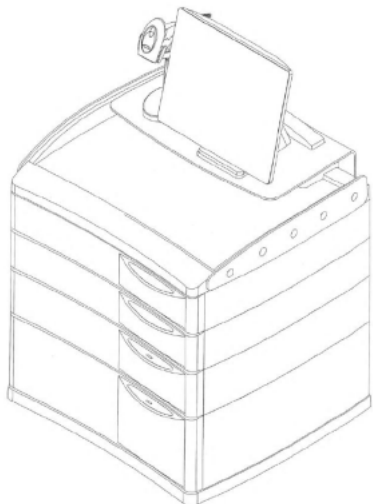

---

[11] 1914857.4

[15] 22-10-2019

[30] 31-05-2019 / TW / 108303286

[51] Cl. 6-04

[54] 調劑台  
Dispensing counter

[73] 吉鴻電子股份有限公司  
台灣  
台北市內湖區  
民權東路 6 段 15 巷 28 號

[74] 偉成國際專利商標事務所  
香港  
九龍彌敦道 430 號  
彌敦商務大廈 13 樓 A 室

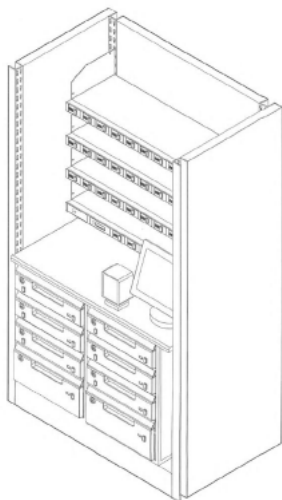



- [11] 1914858.6  
[15] 22-10-2019  
[30] 21-05-2019 / CA, AM, AZ, BZ, BA, GE, LI, MK, MD, MC, MN, ME, MA, NO, OM, RU, SG, CH, TN, TR, GB, EU, AL, KG / DM/203 043  
[51] Cl. 11-01  
[54] 項鍊  
Necklace  
[73] Harry Winston SA  
Chemin du Tourbillon 8, CH-1228 Plan-les-Ouates,  
SWITZERLAND  
[74] SPRUSON & FERGUSON (HONG KONG) LIMITED  
5001 Hopewell Centre  
183 Queen's Road East, Wan Chai  
HONG KONG



- 
- [11] 1914859.8  
[15] 23-10-2019  
[30] 24-04-2019 / US / 29/688,791  
[51] Cl. 7-01  
[54] 餐盒  
Lunch container  
[73] Helen of Troy Limited  
The Phoenix Centre  
George Street, Belleville, St. Michael  
BARBADOS  
[74] BIRD & BIRD  
4/F Three Pacific Place  
1 Queen's Road East  
HONG KONG



---

[11] 1914860.0

[15] 23-10-2019

[51] Cl. 26-06

[54] 單車燈  
Bike light

[73] 傲月有限公司  
Moon Sport Limited  
香港新界元朗  
安樂路 129-149 號  
基達中心 5 樓 507 室

[74] ACCOLADE IP LIMITED  
香港上環  
禧利街 27 號  
富輝商業大廈 10 樓

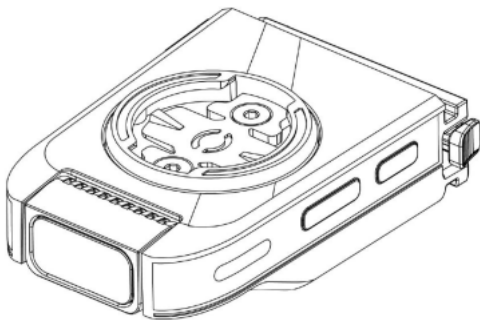

---

[11] 1914863.6

[15] 23-10-2019

[51] Cl. 16-06

[54] 眼鏡臂鉸鏈  
Hinge for arms of glasses

- [73] PAUVAZAL, S.L.  
C/ Badajoz, 5,  
Pozuelo de Alarcón (Madrid) ES 28223  
SPAIN
- [74] GLOBAL IP SERVICE LIMITED  
Unit 1213, 12/F, Wing On Plaza, 62 Mody Road  
Tsim Sha Tsui East, Kowloon  
HONG KONG



- 
- [11] 1914865.1
- [15] 23-10-2019
- [51] Cl. 23-04
- [54] 香薰機  
Aroma diffuser
- [73] Bloomy Lotus Ltd  
Unit 4711, 47/F., The Center,  
99 Queen's Road Central, Central,  
HONG KONG
- [74] FEDERATION OF HONG KONG INDUSTRIES  
31/F, Billion Plaza,  
8 Cheung Yue Street, Cheung Sha Wan, Kowloon  
HONG KONG

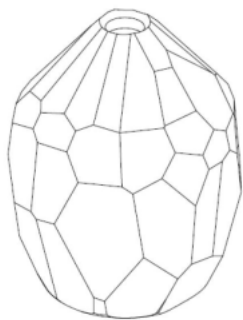

- [11] 1914869.9  
[15] 24-10-2019  
[51] Cl. 14-01  
[54] 帶有充電盒的藍牙耳機  
Bluetooth earphone with charging case  
[73] BOOMPODS (HK) LTD.  
ROOM 303-304 HANKOW CENTRE  
5-15 HANKOW ROAD, T.S.T.  
KOWLOON, HONG KONG  
[74] BOOMPODS (HK) LTD.  
ROOM 303-304 HANKOW CENTRE  
5-15 HANKOW ROAD, T.S.T.  
KOWLOON, HONG KONG



- 
- [11] 1914870.1M001  
[15] 24-10-2019  
[30] 14-05-2019 / EM / 006453668-0001  
[51] Cl. 28-03  
[54] 電髮器  
Hair straighteners  
[73] Dyson Technology Limited  
Tetbury Hill, Malmesbury, Wiltshire, SN16 0RP  
UNITED KINGDOM  
[74] LIU, SHEN & ASSOCIATES  
Room 3716, 37/F, Sun Hung Kai Centre,  
30 Harbour Road, Wanchai,  
HONG KONG

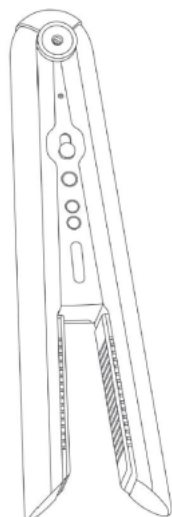

---

[11] 1914870.1M002

[15] 24-10-2019

[30] 14-05-2019 / EM / 006453668-0002

[51] Cl. 28-03

[54] 電髮器

Hair straighteners

[73] Dyson Technology Limited

Tetbury Hill, Malmesbury, Wiltshire, SN16 0RP

UNITED KINGDOM

[74] LIU, SHEN & ASSOCIATES

Room 3716, 37/F, Sun Hung Kai Centre,

30 Harbour Road, Wanchai,

HONG KONG

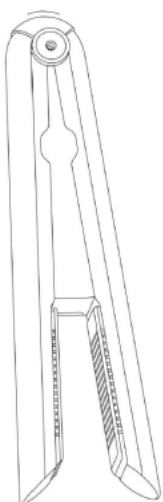

[11] 1914870.1M003

[15] 24-10-2019

[30] 14-05-2019 / EM / 006453668-0003

[51] Cl. 28-03

[54] 電髮器

Hair straighteners

[73] Dyson Technology Limited

Tetbury Hill, Malmesbury, Wiltshire, SN16 0RP  
UNITED KINGDOM

[74] LIU, SHEN & ASSOCIATES

Room 3716, 37/F, Sun Hung Kai Centre,  
30 Harbour Road, Wanchai,  
HONG KONG

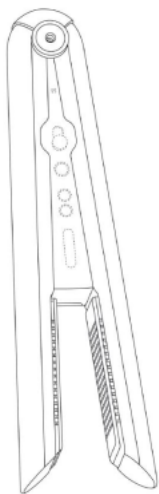



香港特別行政區政府知識產權署外觀設計註冊處

The Government of the Hong Kong Special Administrative Region

Designs Registry, Intellectual Property Department

根據註冊外觀設計條例第 28 條，下列註冊外觀設計因未繳續期費而停止有效。

各組記項按註冊外觀設計停止有效日期及註冊編號先後次序排列。

**Registered designs ceased through non-payment of renewal fees under section 28 of the Registered Designs Ordinance. Entries are listed below under their expiry dates.**

**14-02-2020 - 18-02-2020**

|                   |               |
|-------------------|---------------|
| <b>14-02-2020</b> | 1500482.7M001 |
| 0010174.9         | 1500482.7M002 |
| 0010176.4         | 1500483.9M001 |
| 0500324.1M001     | 1500483.9M002 |
| 1500459.9         | 1500483.9M003 |
|                   | 1500483.9M004 |

**15-02-2020**

1500460.1  
1500461.3  
1500463.7  
1500464.9  
1500465.2  
1500467.6M001  
1500467.6M002  
1500469.0  
1500470.2M001  
1500470.2M002  
1500470.2M003  
1500471.4M001  
1500471.4M002  
1500471.4M003  
1500472.6  
1500473.8

**18-02-2020**

0500341.7

**16-02-2020**

1500476.5  
1500477.7  
1500478.9  
1500479.1M003

**17-02-2020**

0500335.5  
1000298.2  
1000304.6



香港特別行政區政府知識產權署外觀設計註冊處

The Government of the Hong Kong Special Administrative Region

Designs Registry, Intellectual Property Department

根據註冊外觀設計規則第 31 條刪除的註冊外觀設計。各組記項按註冊外觀設計刪除日期及註冊編號先後次序排列。

**Registered designs removed under section 31 of the Registered Designs Rules. Entries are listed below under their removal dates.**

**13-03-2020 - 19-03-2020**

|                   |                   |               |
|-------------------|-------------------|---------------|
| <b>13-03-2020</b> | 0901318.4M002     | 1401548.9     |
| 0901300.6         | 0901318.4M003     | 1401549.1     |
| 0901301.8M001     | 0901325.9M001     | 1401550.3M001 |
| 0901301.8M002     | 0901325.9M003     | 1401553.9     |
| 0901301.8M003     | 1401527.5M001     | 1401555.4     |
| 1401505.9M002     | 1401527.5M002     | 1401557.8     |
| 1401507.3         | 1401527.5M005     | 1401558.0     |
| 1401510.9M001     | 1401529.9M001     | 1401559.2     |
| 1401510.9M003     | 1401529.9M002     | 1401560.4     |
| 1401510.9M004     | 1401530.1         | 1401561.6M003 |
| 1401510.9M005     | 1401531.3         | 1401561.6M004 |
| 1401510.9M006     | 1401532.5         |               |
| 1401510.9M007     | 1401533.7         |               |
| 1401510.9M008     |                   |               |
| 1401510.9M009     | <b>18-03-2020</b> |               |
| 1401511.1M001     | 0411827.1M001     |               |
| 1401511.1M002     | 0411827.1M002     |               |
|                   | 1401535.2         |               |

|                   |               |  |
|-------------------|---------------|--|
| <b>14-03-2020</b> | 1401537.6M001 |  |
| 1401513.5         | 1401537.6M002 |  |
| 1401519.8         | 1401538.8     |  |
| 1401520.0         | 1401539.0     |  |
| 1401521.2         | 1401540.2     |  |
| 1401522.4         | 1401541.4     |  |
|                   | 1401543.8     |  |

|                   |           |  |
|-------------------|-----------|--|
| <b>16-03-2020</b> | 9911084.7 |  |
| 0411819.4M001     |           |  |
| 0901307.1         |           |  |

|                   |                   |  |
|-------------------|-------------------|--|
| <b>17-03-2020</b> | <b>19-03-2020</b> |  |
| 0411822.0M001     | 0901340.0         |  |
| 0411822.0M002     | 0901347.5         |  |
| 0411822.0M003     | 0901348.7         |  |
| 0901318.4M001     | 1401546.5M001     |  |
|                   | 1401546.5M002     |  |
|                   | 1401546.5M003     |  |