

# 香港知識產權公報

Hong Kong Intellectual Property Journal

2020年7月3日

3 July 2020



## 目錄 Contents

### 根據註冊外觀設計條例第 25 條註冊的外觀設計

#### **Designs Registered under section 25 of the Registered Designs Ordinance**

按註冊編號排列

Arranged by Registration Number

### 根據註冊外觀設計條例(第 522 章)公布的其他公告

#### **Other Notices Published under the Registered Designs Ordinance (Cap. 522)**

根據註冊外觀設計條例第 28 條，註冊外觀設計因未繳續期費而停止有效

Registered designs ceased through non-payment of renewal fees under section 28 of the Registered Designs Ordinance

根據註冊外觀設計規則第 31 條刪除的註冊外觀設計

Registered designs removed under section 31 of the Registered Designs Rules

### 以下事項沒有記錄

#### **No Records for the Following Matters**

根據註冊外觀設計條例第 30 條放棄的外觀設計的註冊

Surrender of Registration of Design under section 30 of the Registered Designs Ordinance

根據註冊外觀設計規則第 37 條，向處長作出轉介

Reference to Registrar under section 37 of the Registered Designs Rules

根據註冊外觀設計條例第 45 條，撤銷註冊

Revocation of Registration under section 45 of the Registered Designs Ordinance

根據註冊外觀設計規則第 46 條，向法院作出轉介

Reference to Court under section 46 of the Registered Designs Rules

根據註冊外觀設計規則第 63 條對不符合規定之處作出糾正

Rectification of Irregularities under section 63 of the Registered Designs Rules

根據註冊外觀設計條例第 66 條，糾正註冊紀錄冊

Rectification of Register under section 66 of the Registered Designs Ordinance

根據註冊外觀設計條例第 67 條 更正註冊紀錄冊內的錯誤

Correction of errors in Register under section 67 of the Registered Designs Ordinance

根據註冊外觀設計條例第 67 及 76 條，更正註冊紀錄冊內及已提交文件中的錯誤

Correction of Errors in Register and in Filed Documents under sections 67 and 76 of the Registered Designs Ordinance

根據註冊外觀設計條例第 76 條，更正已提交文件中的錯誤

Correction of errors in filed documents under section 76 of the Registered Designs Ordinance

勘誤

Corrigendum

## 註冊外觀設計公告註釋

### Notes on advertisements of registration of designs

方括號表示下列資料：

Square brackets indicate the following data：

[11] 註冊編號 Registration number / 聯合王國註冊編號 United Kingdom registration number

[15] 註冊日期 Registration date / 當作註冊日期 Deemed registration date / 聯合王國註冊日期 United Kingdom registration date

[17] 註冊有效期屆滿日期 Expiry date of the period of registration

[22] 提交日期 Filing date / 當作提交日期 Deemed filing date / 聯合王國提交日期 United Kingdom filing date

[30] 聲稱享有的優先權（提交日期 / 巴黎公約國或世界貿易組織成員 / 申請編號） Priority claimed (filing date / Paris Convention country or WTO member / application number)

[51] 國際外觀設計分類號（洛迦諾分類號） International Classification of designs (Locarno Classification)

[54] 物品 Article

[55] 外觀設計的表述 Representation of the design

[62] 分開前的申請編號及提交日期 Application number before division and filing date

[66] 過往註冊的聯繫外觀設計註冊編號 / 日期 Registration No. / Date of Previous Registration for Association

[72] 設計人 Designer

[73] 擁有人姓名和地址 Name and address of the owner

[74] 代理人 Agent / 送達地址 Address for service



香港特別行政區政府知識產權署外觀設計註冊處

The Government of the Hong Kong Special Administrative Region

Designs Registry, Intellectual Property Department

## 根據註冊外觀設計條例第 25 條註冊的外觀設計

### Designs registered under section 25 of the Registered Designs Ordinance

按註冊編號排列

Arranged by Registration Number

[11] 1914227.8M001

[15] 15-07-2019

[51] Cl. 9-03

[54] 用於包裝的裝飾

Ornamentation for packaging

[73] LOUIS VUITTON MALLETIER

2 rue du Pont-Neuf

75001 Paris

FRANCE

[74] BAKER & MCKENZIE

14TH FLOOR, ONE TAIKOO PLACE,

979 KING'S ROAD, QUARRY BAY,

HONG KONG

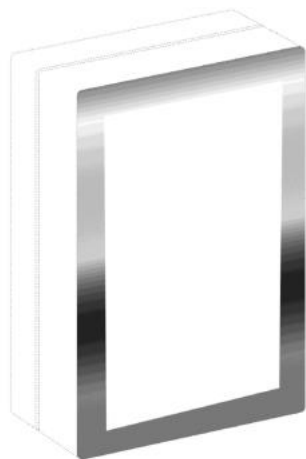

---

[11] 1914227.8M002

[15] 15-07-2019

[51] Cl. 9-03

[54] 用於包裝的裝飾  
Ornamentation for packaging

[73] LOUIS VUITTON MALLETIER  
2 rue du Pont-Neuf  
75001 Paris  
FRANCE

[74] BAKER & MCKENZIE  
14TH FLOOR, ONE TAIKOO PLACE,  
979 KING'S ROAD, QUARRY BAY,  
HONG KONG

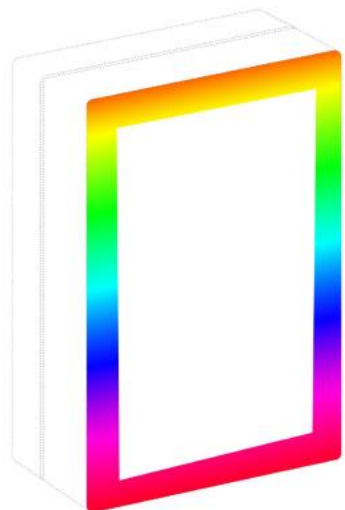

---

[11] 1914714.1M001

[15] 24-09-2019

[30] 25-03-2019 / US / 29/685,000

[51] Cl. 14-01

[54] 耳機  
Earphone

[73] 蘋果公司  
APPLE INC.  
ONE APPLE PARK WAY, CUPERTINO, CALIFORNIA 95014  
UNITED STATES OF AMERICA

[74] CLT PATENT & TRADEMARK (H.K.) LIMITED  
Unit 09, 34/F., Office Tower, Convention Plaza  
No. 1 Harbour Road, Wanchai  
HONG KONG

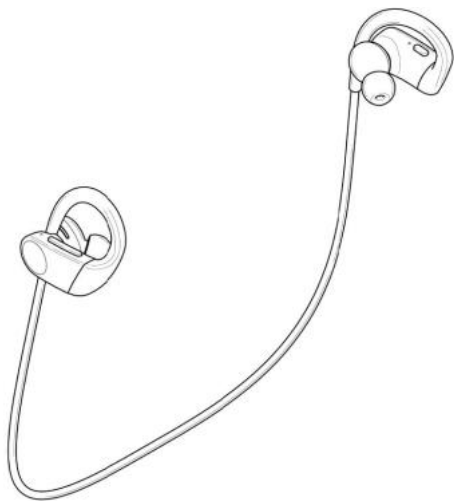

---

[11] 1914714.1M002

[15] 24-09-2019

[30] 25-03-2019 / US / 29/685,000

[51] Cl. 14-01

[54] 耳機

Earphone

[73] 蘋果公司

APPLE INC.

ONE APPLE PARK WAY, CUPERTINO, CALIFORNIA 95014

UNITED STATES OF AMERICA

[74] CLT PATENT & TRADEMARK (H.K.) LIMITED

Unit 09, 34/F., Office Tower, Convention Plaza

No. 1 Harbour Road, Wanchai

HONG KONG

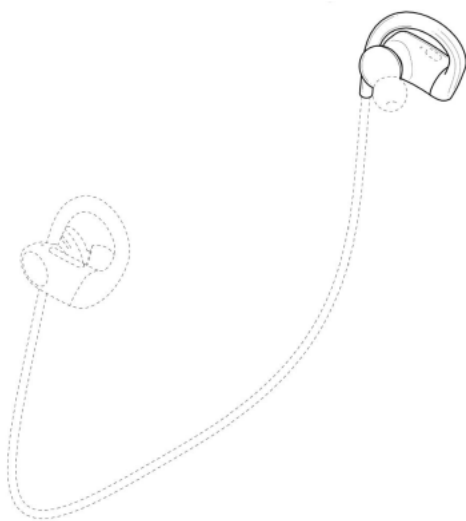



[11] 1914714.1M003

[15] 24-09-2019

[30] 25-03-2019 / US / 29/685,000

[51] Cl. 14-01

[54] 耳機

Earphone

[73] 蘋果公司

APPLE INC.

ONE APPLE PARK WAY, CUPERTINO, CALIFORNIA 95014

UNITED STATES OF AMERICA

[74] CLT PATENT & TRADEMARK (H.K.) LIMITED

Unit 09, 34/F., Office Tower, Convention Plaza

No. 1 Harbour Road, Wanchai

HONG KONG



[11] 1914714.1M004

[15] 24-09-2019

[30] 25-03-2019 / US / 29/685,000

[51] Cl. 14-01

[54] 耳機

Earphone

[73] 蘋果公司

APPLE INC.

ONE APPLE PARK WAY, CUPERTINO, CALIFORNIA 95014

UNITED STATES OF AMERICA

[74] CLT PATENT & TRADEMARK (H.K.) LIMITED

Unit 09, 34/F., Office Tower, Convention Plaza

No. 1 Harbour Road, Wanchai

HONG KONG

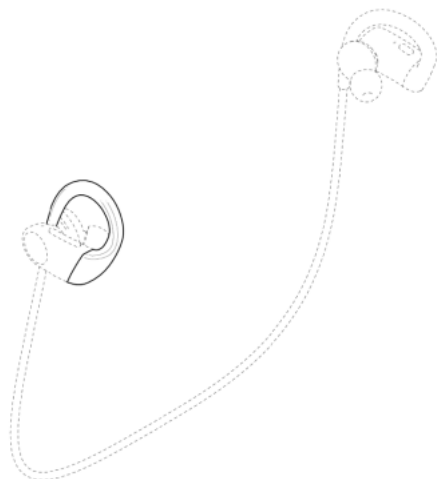

---

[11] 1914794.9

[15] 09-10-2019

[30] 10-04-2019 / US / 29/687,057

[51] Cl. 14-03

[54] 傳聲器裝置

Microphone unit

[73] 寶利通公司

POLYCOM, INC.

6001 America Center Drive, San Jose, CA 95002

UNITED STATES OF AMERICA

[74] SHANGHAI INTELLECTUAL PROPERTY OFFICE

Unit F, 20th Floor, Neich Tower,

128 Gloucester Road,

HONG KONG

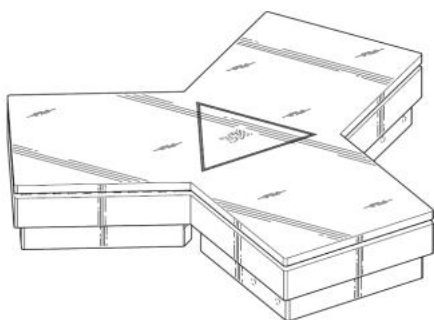

---

[11] 1914854.7

[15] 22-10-2019

[30] 26-04-2019 / KR / 30-2019-0019841

[51] Cl. 24-01

[54] 皮膚護理器遙控盒子

Case for skin treatment apparatus remote control

[73] LG ELECTRONICS INC.

128, Yeoui-daero,

Yeongdeungpo-gu

Seoul, REPUBLIC OF KOREA

[74] NORTON ROSE FULBRIGHT HONG KONG

38/F Jardine House, 1 Connaught Place

Central

HONG KONG



---

[11] 1915106.3

[15] 28-11-2019

[51] Cl. 7-05

[54] 蒸氣熨斗

Steam iron

[73] TUNBOW GROUP LIMITED

10/F,Block A, Chung Mei Centre

No.15 Hing Yip Street, Kwun Tong

HONG KONG

[74] SIMON LEE

10/F,Block A, Chung Mei Centre

No.15 Hing Yip Street, Kwun Tong

HONG KONG



---

[11] 1915108.7

[15] 28-11-2019

[51] Cl. 7-02

[54] 咖啡機

Coffee machine

[73] TUNBOW GROUP LIMITED

10/F, Block A, Chung Mei Centre  
No.15 Hing Yip Street, Kwun Tong  
HONG KONG

[74] SIMON LEE

10/F, Block A, Chung Mei Centre  
No. 15 Hing Yip Street, Kwun Tong  
HONG KONG



---

[11] 1915152.9

[15] 02-12-2019

[30] 20-09-2019 / CN / 201930518405.8

[51] Cl. 14-03

Cl. 14-02

Cl. 14-01

- [54] 自助服務亭  
Self service kiosk
- [73] K11 集團有限公司  
K11 Group Limited  
10/F, Inter-Continental Plaza,  
94 Granville Road, Tsim Sha Tsui
- [74] Eagle Ip Limited  
Room 509, Global Gateway Tower,  
63 Wing Hong Street, Lai Chi Kok, Kowloon,  
Hong Kong

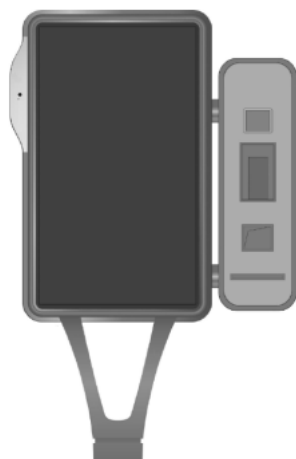

- 
- [11] 1915238.2
- [15] 16-12-2019
- [30] 31-07-2019 / CN / 201930414237.8
- [51] Cl. 14-02
- [54] 電子手寫板  
Electronic writing board
- [73] 北京小米移動軟件有限公司  
BEIJING XIAOMI MOBILE SOFTWARE CO., LTD.  
No.018, Floor 8, Building 6, Yard 33,  
Middle Xierqi Road, Haidian District,  
Beijing 100085, China
- [74] ACCOLADE IP LIMITED  
10/F, Fu Fai Comm. Ctr.,  
27 Hillier Street, Sheung Wan,  
HONG KONG



---

[11] 1915314.3

[15] 24-12-2019

[51] Cl. 13-02

[54] 無線充移動電源

Wireless portable power bank

[73] 杰美泰實業（深圳）有限公司

中國內地

廣東省深圳市寶安區沙井街道

茅洲山工業園工業大廈

全至科技創新園科創大廈 14 層 G

[74] 海思國際知識產權有限公司

香港灣仔

駱克道 301-307 號

洛克中心 19 樓 C 室



---

[11] 1915315.6

[15] 24-12-2019

[51] Cl. 13-02

- [54] 無線充電座  
Wireless charger base
- [73] 杰美泰實業（深圳）有限公司  
中國內地  
廣東省深圳市寶安區沙井街道  
茅洲山工業園工業大廈  
全至科技創新園科創大廈 14 層 G
- [74] 海思國際知識產權有限公司  
香港灣仔  
駱克道 301-307 號  
洛克中心 19 樓 C 室

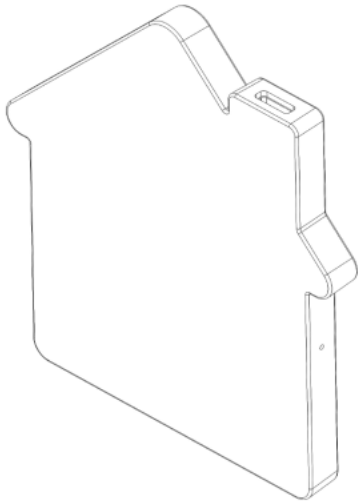

- 
- [11] 1915347.3
- [15] 31-12-2019
- [51] C1. 13-02
- [54] 移動電源  
Portable power bank
- [73] 杰美泰實業（深圳）有限公司  
中國內地  
廣東省深圳市寶安區沙井街道  
茅洲山工業園工業大廈全至科技創新園科創大廈 14 層 G
- [74] 海思國際知識產權有限公司  
香港  
灣仔駱克道 301-307 號  
洛克中心 19 樓 C 室



---

[11] 2015356.5M001

[15] 02-01-2020

[51] Cl. 7-01

[54] 杯  
Cup

[73] Li Wei Han, Rosanna  
Flat 2, 7/F, Koon Fook Centre,  
9 Knutsford Terrace, Tsim Sha Tsui, Kowloon, Hong Kong

[74] WE ARE NO EXPERT LIMITED  
Flat 2, 7/F, Koon Fook Centre,  
9 Knutsford Terrace, Tsim Sha Tsui, Kowloon, Hong Kong

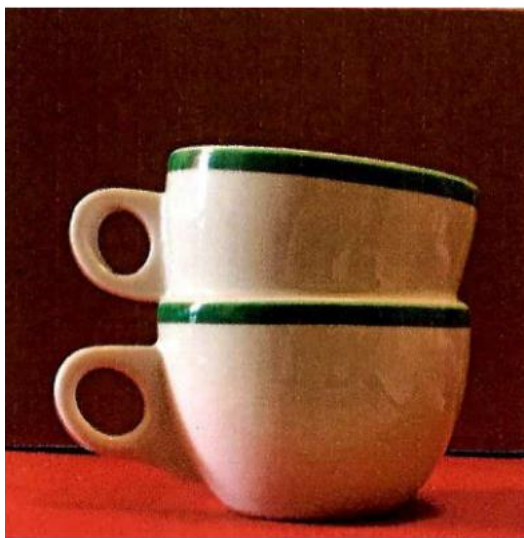

---

[11] 2015356.5M002

[15] 02-01-2020

[51] Cl. 7-01



[54] 杯  
Cup

[73] Li Wei Han, Rosanna  
Flat 2, 7/F, Koon Fook Centre,  
9 Knutsford Terrace, Tsim Sha Tsui, Kowloon, Hong Kong

[74] WE ARE NO EXPERT LIMITED  
Flat 2, 7/F, Koon Fook Centre,  
9 Knutsford Terrace, Tsim Sha Tsui, Kowloon, Hong Kong

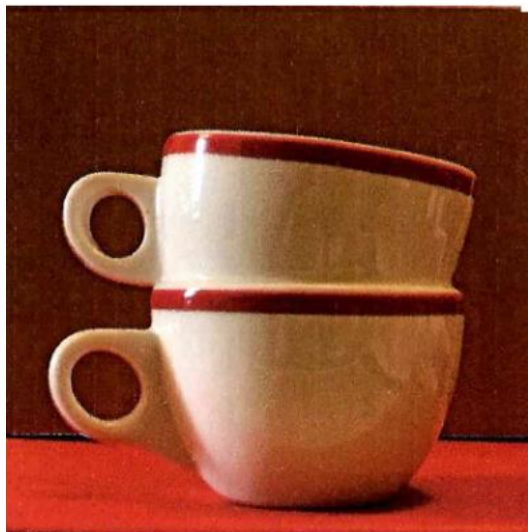

---

[11] 2015405.0M001

[15] 13-01-2020

[30] 25-12-2019 / IL / 64599

[51] Cl. 21-01

[54] 水玩玩具  
Water toy

[73] Global Marketing Enterprise (GME) Ltd.  
P.O.B 25202,  
Tel Aviv 6125101,  
Israel

[74] WOO KWAN LEE & LO  
Room 2801, Sun Hung Kai Centre,  
30 Harbour Road,  
Wanchai, Hong Kong

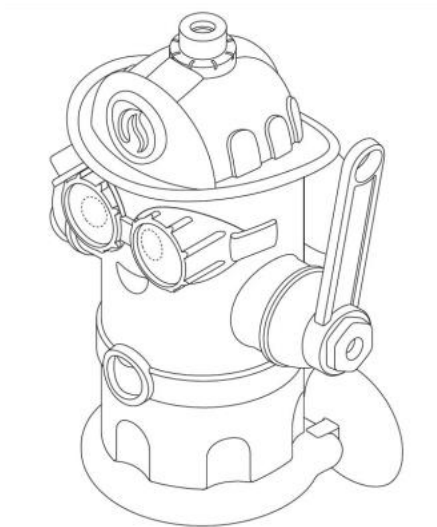

---

[11] 2015405.0M002

[15] 13-01-2020

[30] 25-12-2019 / IL / 64602

[51] Cl. 21-01

[54] 水玩玩具

Water toy

[73] Global Marketing Enterprise (GME) Ltd.

P.O.B 25202,

Tel Aviv 6125101,

Israel

[74] WOO KWAN LEE & LO

Room 2801, Sun Hung Kai Centre,

30 Harbour Road,

Wanchai, Hong Kong

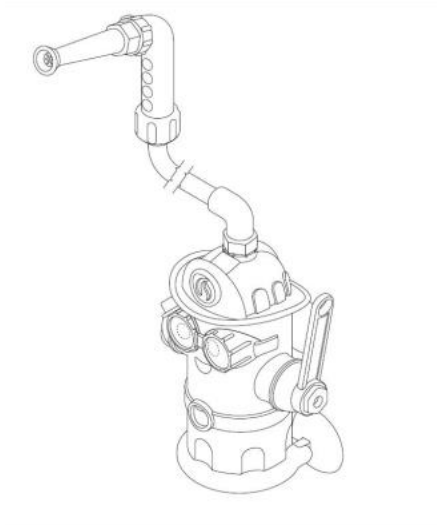

[11] 2015405.0M003

[15] 13-01-2020

[30] 29-12-2019 / IL / 64625

[51] Cl. 21-01

[54] 大象漏斗水玩具

Elephant funnel water toy

[73] Global Marketing Enterprise (GME) Ltd.

P.O.B 25202,

Tel Aviv 6125101,

Israel

[74] WOO KWAN LEE & LO

Room 2801, Sun Hung Kai Centre,

30 Harbour Road,

Wanchai, Hong Kong

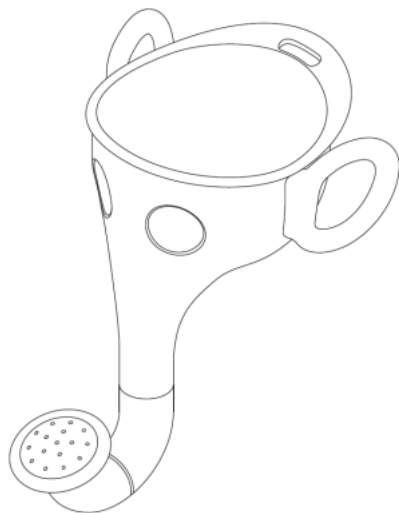

---

[11] 2015471.8

[15] 22-01-2020

[30] 23-07-2019 / FR / 20193354

[51] Cl. 28-03

[54] 皮膚治療儀或儀器

Skin treatment device or apparatus

[73] INDERM, SAS

4 rue Meissonier 75017,

Paris,

France

[74] FAIRBAIRN CATLEY LOW & KONG

23/F, Shui On Centre

6-8 Harbour Road,

Wanchai, Hong Kong



---

[11] 2015472.0

[15] 22-01-2020

[30] 10-09-2019 / EU / 006852828-0001

[51] Cl. 21-01

[54] 玩具車

Toy car

[73] 力確玩具有限公司

NIKKO TOYS LIMITED

Room 2901, 29th Floor, Shui On Centre,

6-8 Harbour Road,

Wanchai, Hong Kong

[74] VINCENT LUK & ASSOCIATES

Unit A, 13th Floor,

Nathan Commercial Building,

430 Nathan Road, Kowloon, Hong Kong



---

[11] 2015473.2

[15] 22-01-2020

[51] Cl. 3-01

[54] 12 弦豎琴袋

12 String harp bag

[73] 黃芷君以貝貝琴之名營業

Wong Chi Kwan Corinna trading as Baby Harp

香港九龍尖沙咀

亞士厘道 34 號

天星大廈 12 樓 A6 室

- [74] Baby Harp  
香港九龍尖沙咀  
亞士厘道 34 號  
天星大廈 12 樓 A6 室



- 
- [11] 2015474.4M001  
[15] 22-01-2020  
[30] 23-07-2019 / SG, CH, GB, EU / DM/202 835  
[51] Cl. 11-01  
[54] 胸針  
Brooch  
[73] VAN CLEEF & ARPELS SA  
Route des Biches 8,  
1752 Villars-sur-Glâne,  
Switzerland  
[74] UNION PATENT SERVICE CENTRE  
Units E-F, 20th Floor, Neich Tower,  
128 Gloucester Road,  
Hong Kong

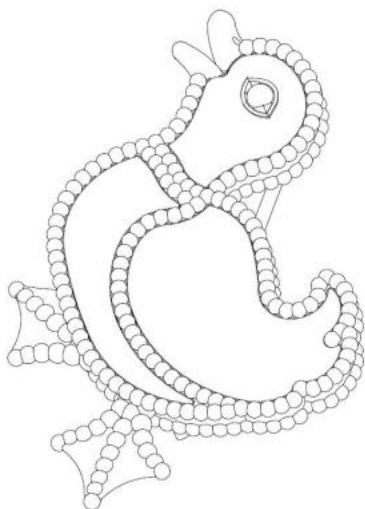

---

[11] 2015474.4M002

[15] 22-01-2020

[30] 23-07-2019 / SG, CH, GB, EU / DM/202 835

[51] Cl. 11-01

[54] 胸針

Brooch

[73] VAN CLEEF & ARPELS SA

Route des Biches 8,  
1752 Villars-sur-Glâne,  
Switzerland

[74] UNION PATENT SERVICE CENTRE

Units E-F, 20th Floor, Neich Tower,  
128 Gloucester Road,  
Hong Kong

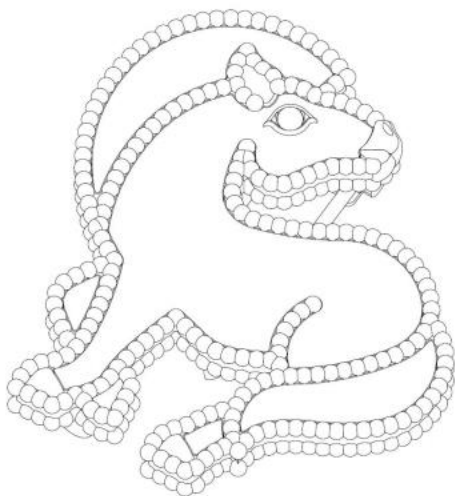

- [11] 2015474.4M003  
[15] 22-01-2020  
[30] 23-07-2019 / SG, CH, GB, EU / DM/202 835  
[51] Cl. 11-01  
[54] 胸針  
Brooch  
[73] VAN CLEEF & ARPELS SA  
Route des Biches 8,  
1752 Villars-sur-Glâne,  
Switzerland  
[74] UNION PATENT SERVICE CENTRE  
Units E-F, 20th Floor, Neich Tower,  
128 Gloucester Road,  
Hong Kong

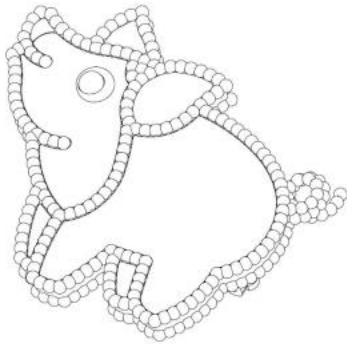

- 
- [11] 2015474.4M004  
[15] 22-01-2020  
[30] 23-07-2019 / SG, CH, GB, EU / DM/202 835  
[51] Cl. 11-01  
[54] 胸針  
Brooch  
[73] VAN CLEEF & ARPELS SA  
Route des Biches 8,  
1752 Villars-sur-Glâne,  
Switzerland  
[74] UNION PATENT SERVICE CENTRE  
Units E-F, 20th Floor, Neich Tower,  
128 Gloucester Road,  
Hong Kong

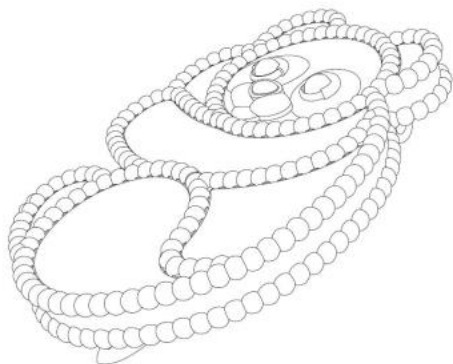

---

[11] 2015474.4M005

[15] 22-01-2020

[30] 23-07-2019 / SG, CH, GB, EU / DM/202 835

[51] Cl. 11-01

[54] 胸針

Brooch

[73] VAN CLEEF & ARPELS SA

Route des Biches 8,  
1752 Villars-sur-Glâne,  
Switzerland

[74] UNION PATENT SERVICE CENTRE

Units E-F, 20th Floor, Neich Tower,  
128 Gloucester Road,  
Hong Kong

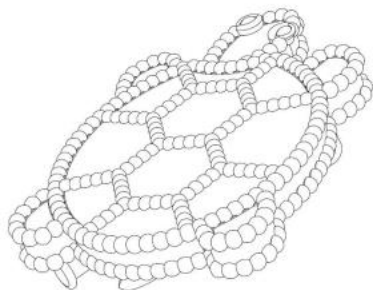



[11] 2015475.7

[15] 22-01-2020

[51] Cl. 21-01

[54] 菱形多維積木組件

Rhombus shaped multidimensional building block assembly

[73] POWER, Oddette L.

Poblacion, Lingig, Surigao del sur,  
Mindanao, 8312,  
Philippines

天峰佳有限公司

TFK SKY LIMITED

Units 1610-1611, 16/F, Two Harbourfront,  
22 Tak Fung Street,  
Hung Hom, Kowloon,  
Hong Kong

[74] TRADEMARKCN COMPANY LIMITED

Block A, 4/F., Granville Building,  
14 Granville Road,  
Tsim Sha Tsui, Kowloon,  
Hong Kong

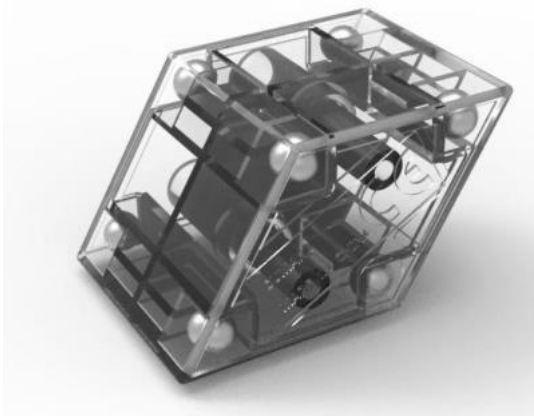

[11] 2015476.9

[15] 22-01-2020

[51] Cl. 21-01

[54] 一種多維積木組件連梯形盒

A multidimensional building block assembly with trapezoid case

[73] POWER, Oddette L.

Poblacion, Lingig, Surigao del sur,  
Mindanao, 8312,  
Philippines

天峰佳有限公司

TFK SKY LIMITED  
Units 1610-1611, 16/F, Two Harbourfront,  
22 Tak Fung Street,  
Hung Hom, Kowloon,  
Hong Kong

[74] TRADEMARKCN COMPANY LIMITED  
Block A, 4/F., Granville Building,  
14 Granville Road,  
Tsim Sha Tsui, Kowloon,  
Hong Kong

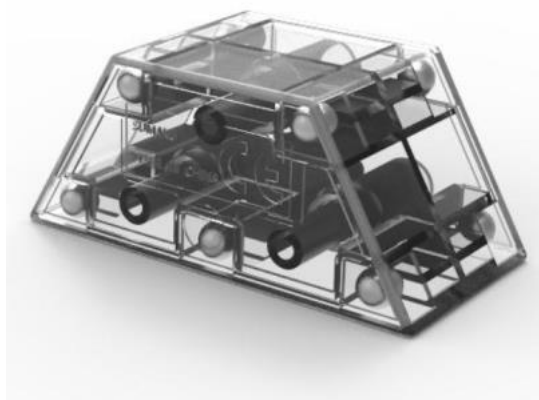

[11] 2015477.1

[15] 22-01-2020

[51] Cl. 21-01

[54] 圓柱體形多維積木組件  
Cylinder shaped multidimensional building block assembly

[73] POWER, Oddette L.  
Poblacion, Lingig, Surigao del sur,  
Mindanao, 8312,  
Philippines

天峰佳有限公司

TFK SKY LIMITED  
Units 1610-1611, 16/F, Two Harbourfront,  
22 Tak Fung Street,  
Hung Hom, Kowloon,  
Hong Kong

[74] TRADEMARKCN COMPANY LIMITED  
Block A, 4/F., Granville Building,  
14 Granville Road,  
Tsim Sha Tsui, Kowloon,  
Hong Kong

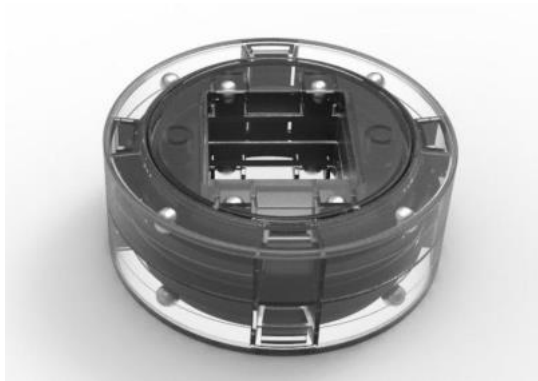

[11] 2015478.3

[15] 22-01-2020

[51] Cl. 21-01

[54] 一種球形多維積木組件

A spherical multidimensional building block assembly

[73] POWER, Oddette L.

Poblacion, Lingig, Surigao del sur,

Mindanao, 8312,

Philippines

天峰佳有限公司

TFK SKY LIMITED

Units 1610-1611, 16/F, Two Harbourfront,

22 Tak Fung Street,

Hunghom, Kowloon,

Hong Kong

[74] TRADEMARKCN COMPANY LIMITED

Block A, 4/F., Granville Building,

14 Granville Road,

Tsim Sha Tsui, Kowloon,

Hong Kong



[11] 2015479.5

[15] 22-01-2020

[30] 16-08-2019 / KR / 30-2019-0039267

[51] Cl. 28-03

[54] 粉盒容器

Compact container

[73] AMOREPACIFIC CORPORATION

100, Hangang-daero,

Yongsan-gu, Seoul,

Korea, Republic of

[74] TRADEMARKCN COMPANY LIMITED

Block A, 4/F., Granville Building,

14 Granville Road,

Tsim Sha Tsui, Kowloon,

Hong Kong



[11] 2015480.7

[15] 23-01-2020

[30] 29-08-2019 / JP / 019233 of 2019

[51] Cl. 21-01

[54] 棒玩具

Stick toy

[73] AGATSUMA CO., LTD.

19-4, Asakusabashi 3-chome,

Taito-ku, Tokyo,

Japan

[74] WILKINSON & GRIST

6th Floor, Prince's Building,

Chater Road,

Hong Kong



---

[11] 2015481.9

[15] 23-01-2020

[30] 06-08-2019 / NO, SG, CH, EU, JP, KR / DM/202 663

[51] Cl. 31-00

[54] 電咖啡研磨機

Electric coffee grinder

[73] Pi-Design AG

Kantonsstrasse 100,

CH-6234 Triengen,

Switzerland

[74] Wenping Patent & Trade Mark Agent Limited

1701 Tung Wai Commercial Building,

111 Gloucester Road,

Hong Kong

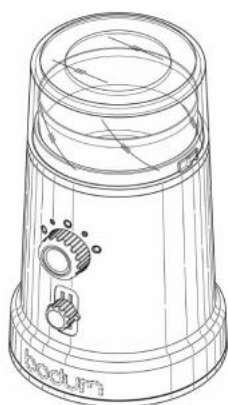

---

[11] 2015482.1M001

[15] 23-01-2020

[30] 24-01-2019 / EP / 006644316-0001

[51] Cl. 9-07

[54] 瓶蓋

Bottle cap

[73] 雷克特本克斯爾健康有限公司

Reckitt Benckiser Health Limited

103-105 Bath Road, Slough,

Berkshire, SL1 3UH,

United Kingdom

[74] SANYOU INTELLECTUAL PROPERTY LTD.

ROOM 601, 6/F., YUE XIU BUILDING,

160-174 LOCKHART ROAD, WANCHAI,

HONG KONG

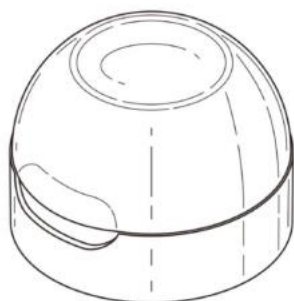

---

[11] 2015482.1M002

[15] 23-01-2020

[30] 24-01-2019 / EP / 006644316-0002

[51] Cl. 9-01

[54] 瓶子

Bottle

[73] 雷克特本克斯爾健康有限公司

Reckitt Benckiser Health Limited

103-105 Bath Road, Slough,

Berkshire, SL1 3UH,

United Kingdom

[74] SANYOU INTELLECTUAL PROPERTY LTD.

ROOM 601, 6/F., YUE XIU BUILDING,

160-174 LOCKHART ROAD, WANCHAI,

HONG KONG

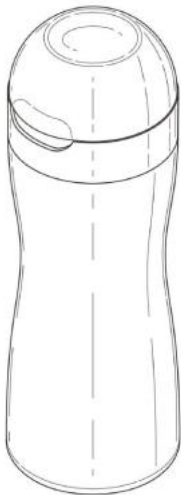

---

[11] 2015482.1M003

[15] 23-01-2020

[30] 24-01-2019 / EP / 006644316-0003

[51] Cl. 9-01

[54] 瓶子

Bottle

[73] 雷克特本克斯爾健康有限公司

Reckitt Benckiser Health Limited

103-105 Bath Road, Slough,

Berkshire, SL1 3UH,

United Kingdom

[74] SANYOU INTELLECTUAL PROPERTY LTD.

ROOM 601, 6/F., YUE XIU BUILDING,

160-174 LOCKHART ROAD, WANCHAI,

HONG KONG

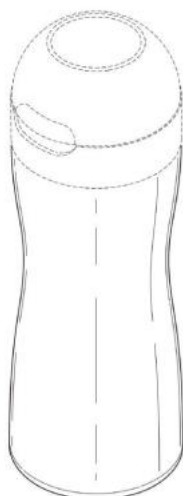

- [11] 2015488.4M001
- [15] 23-01-2020
- [30] 30-08-2019 / AM, AZ, BZ, BA, GE, LI, MK, MD, MC, MN, ME, NO, OM, SG, CH, TN, TR, UA, GB, EU, AL, KG / DM/203 373
- [51] Cl. 10-07
- [54] 錶面  
Dial
- [73] BLANCPAIN SA  
Le Rocher 12,  
CH-1348 Le Brassus,  
Switzerland
- [74] SPRUSON & FERGUSON (HONG KONG) LIMITED  
5001 Hopewell Centre  
183 Queen's Road East,  
Wan Chai, Hong Kong

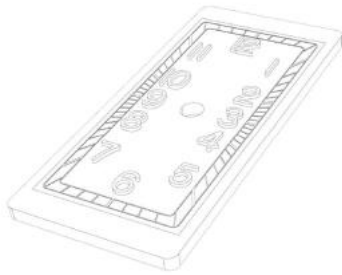

- 
- [11] 2015488.4M002
- [15] 23-01-2020
- [30] 30-08-2019 / AM, AZ, BZ, BA, GE, LI, MK, MD, MC, MN, ME, NO, OM, SG, CH, TN, TR, UA, GB, EU, AL, KG / DM/203 373
- [51] Cl. 10-07
- [54] 錶面  
Dial
- [73] BLANCPAIN SA  
Le Rocher 12,  
CH-1348 Le Brassus,  
Switzerland
- [74] SPRUSON & FERGUSON (HONG KONG) LIMITED  
5001 Hopewell Centre  
183 Queen's Road East,  
Wan Chai, Hong Kong





---

[11] 2015488.4M003

[15] 23-01-2020

[30] 30-08-2019 / AM, AZ, BZ, BA, GE, LI, MK, MD, MC, MN, ME, NO,  
OM, SG, CH, TN, TR, UA, GB, EU, AL, KG / DM/203 373

[51] Cl. 10-07

[54] 錶面  
Dial

[73] BLANCPAIN SA  
Le Rocher 12,  
CH-1348 Le Brassus,  
Switzerland

[74] SPRUSON & FERGUSON (HONG KONG) LIMITED  
5001 Hopewell Centre  
183 Queen's Road East,  
Wan Chai, Hong Kong



---

[11] 2015488.4M004

[15] 23-01-2020

[30] 30-08-2019 / AM, AZ, BZ, BA, GE, LI, MK, MD, MC, MN, ME, NO, OM, SG, CH, TN, TR, UA, GB, EU, AL, KG / DM/203 373

[51] Cl. 10-07

[54] 錶面  
Dial

[73] BLANCPAIN SA  
Le Rocher 12,  
CH-1348 Le Brassus,  
Switzerland

[74] SPRUSON & FERGUSON (HONG KONG) LIMITED  
5001 Hopewell Centre  
183 Queen's Road East,  
Wan Chai, Hong Kong



---

[11] 2015488.4M005

[15] 23-01-2020

[30] 30-08-2019 / AM, AZ, BZ, BA, GE, LI, MK, MD, MC, MN, ME, NO, OM, SG, CH, TN, TR, UA, GB, EU, AL, KG / DM/203 373

[51] Cl. 10-07

[54] 錶面  
Dial

[73] BLANCPAIN SA  
Le Rocher 12,  
CH-1348 Le Brassus,  
Switzerland

[74] SPRUSON & FERGUSON (HONG KONG) LIMITED  
5001 Hopewell Centre  
183 Queen's Road East,  
Wan Chai, Hong Kong



---

[11] 2015489.6

[15] 23-01-2020

[30] 19-08-2019 / US / 29/702,388

[51] Cl. 28-03

[54] 頭髮造型器

Hair styling apparatus

[73] Helen of Troy Limited

The Financial Services Centre,  
Bishop's Court Hill Suite 1, Ground Floor,  
St. Michael, BB14004,  
Barbados

[74] Bird & Bird

6/F, The Annex, Central Plaza  
18 Harbour Road  
Hong Kong

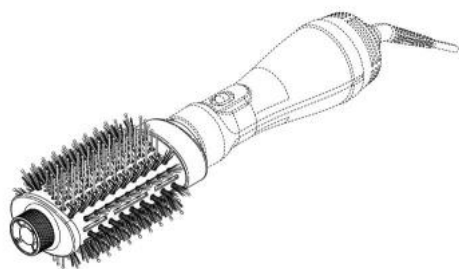

---

[11] 2015490.8

[15] 23-01-2020

[30] 30-07-2019 / IN / 320200-001

[51] Cl. 15-09

[54] 拉坯機

Potter's wheel

[73] R · 瓦殊戴夫

Vasudev · R

No. 17/9, 2nd Floor, Ibrahim Sahib Street,  
First Lane, George Town, Chennai - 600 001,  
Tamil Nadu, India

[74] JEAC I.P. AGENT COMPANY

Rm.1905 Nan Fung Centre,  
264-298 Castle Peak Road,  
Tsuen Wan, Hong Kong

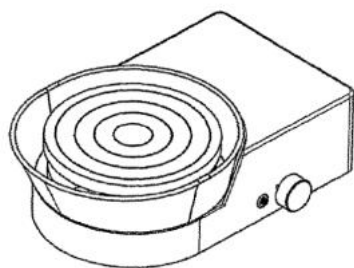

---

[11] 2015491.0

[15] 23-01-2020

[51] Cl. 21-01

[54] 立體玩具企鵝形拼圖

3-Dimensional toy penguin shaped puzzle

[73] 愛立實業有限公司

Jeruel Industrial Company Limited  
Unit F, 16/F., Gold King Industrial Building,  
35-41 Tai Lin Pai Road,  
Kwai Chung, N.T.,  
Hong Kong

[74] ACCOLADE IP LIMITED

10/F, Fu Fai Comm. Ctr.,  
27 Hillier Street,  
Sheung Wan, Hong Kong



---

[11] 2015492.2

[15] 24-01-2020

[30] 29-07-2019 / EU / 006652210

[51] Cl. 12-08

[54] 汽車

Car

[73] FERRARI S.p.A.

Via Emilia Est 1163

I-41100 Modena

Italy

[74] CHINA PATENT AGENT (HONG KONG) LIMITED

22/F, Great Eagle Centre,

23 Harbour Road,

Wanchai, Hong Kong

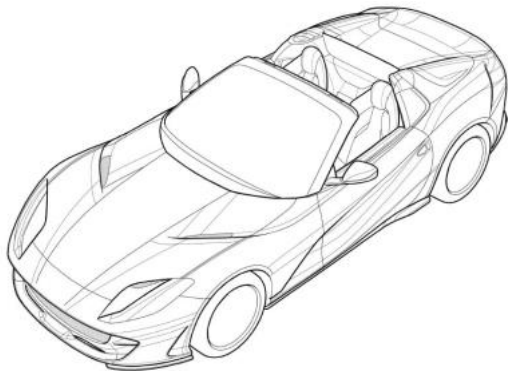

---

[11] 2015493.4

[15] 24-01-2020

[30] 29-07-2019 / EU / 006652236

[51] Cl. 21-01

[54] 玩具汽車  
Toy car

[73] FERRARI S.p.A.  
Via Emilia Est 1163  
I-41100 Modena  
Italy

[74] CHINA PATENT AGENT (HONG KONG) LIMITED  
22/F, Great Eagle Centre,  
23 Harbour Road,  
Wanchai, Hong Kong

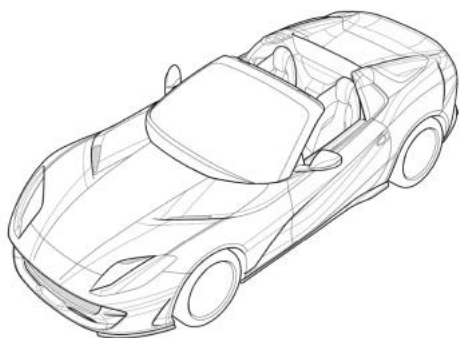

[11] 2015494.6M001

[15] 24-01-2020

[30] 01-08-2019 / CN / 201930416543.5

[51] Cl. 9-03

[54] 包裝盒  
Packing box

[73] 好侍食品集團本社株式會社  
HOUSE FOODS GROUP INC.  
日本大阪府東大阪市  
御厨栄町1丁目5番7號

[74] 范紀羅江律師行  
香港灣仔  
港灣道6-8號  
瑞安中心23樓



- [11] 2015494.6M002  
[15] 24-01-2020  
[30] 01-08-2019 / CN / 201930416543.5  
[51] Cl. 9-03  
[54] 包裝盒  
Packing box  
[73] 好侍食品集團本社株式會社  
HOUSE FOODS GROUP INC.  
日本大阪府東大阪市  
御厨栄町1丁目5番7號  
[74] 范紀羅江律師行  
香港灣仔  
港灣道6-8號  
瑞安中心23樓



- 
- [11] 2015495.9M001  
[15] 24-01-2020  
[30] 14-08-2019 / CN / 201930441842.4  
[51] Cl. 13-03  
[54] 開關  
Switch  
[73] SCHNEIDER ELECTRIC (AUSTRALIA) PTY LTD  
78 Waterloo Road  
Macquarie Park, Nsw 2113  
Australia  
[74] Wenping Patent & Trade Mark Agent Limited  
1701 Tung Wai Commercial Building,  
111 Gloucester Road,  
Hong Kong



---

[11] 2015495.9M002

[15] 24-01-2020

[30] 14-08-2019 / CN / 201930441842.4

[51] Cl. 13-03

[54] 開關

Switch

[73] SCHNEIDER ELECTRIC (AUSTRALIA) PTY LTD

78 Waterloo Road

Macquarie Park, Nsw 2113

Australia

[74] Wenping Patent & Trade Mark Agent Limited

1701 Tung Wai Commercial Building,

111 Gloucester Road,

Hong Kong



---

[11] 2015495.9M003



- [15] 24-01-2020
- [30] 14-08-2019 / CN / 201930441842.4
- [51] Cl. 13-03
- [54] 開關  
Switch
- [73] SCHNEIDER ELECTRIC (AUSTRALIA) PTY LTD  
78 Waterloo Road  
Macquarie Park, Nsw 2113  
Australia
- [74] Wenping Patent & Trade Mark Agent Limited  
1701 Tung Wai Commercial Building,  
111 Gloucester Road,  
Hong Kong



- 
- [11] 2015495.9M004
- [15] 24-01-2020
- [30] 14-08-2019 / CN / 201930441842.4
- [51] Cl. 13-03
- [54] 開關  
Switch
- [73] SCHNEIDER ELECTRIC (AUSTRALIA) PTY LTD  
78 Waterloo Road  
Macquarie Park, Nsw 2113  
Australia
- [74] Wenping Patent & Trade Mark Agent Limited  
1701 Tung Wai Commercial Building,  
111 Gloucester Road,  
Hong Kong



---

[11] 2015495.9M005

[15] 24-01-2020

[30] 14-08-2019 / CN / 201930441842.4

[51] Cl. 13-03

[54] 開關

Switch

[73] SCHNEIDER ELECTRIC (AUSTRALIA) PTY LTD

78 Waterloo Road

Macquarie Park, Nsw 2113

Australia

[74] Wenping Patent & Trade Mark Agent Limited

1701 Tung Wai Commercial Building,

111 Gloucester Road,

Hong Kong



[11] 2015495.9M006

[15] 24-01-2020

[30] 14-08-2019 / CN / 201930441842.4

[51] Cl. 13-03

[54] 開關

Switch

[73] SCHNEIDER ELECTRIC (AUSTRALIA) PTY LTD

78 Waterloo Road

Macquarie Park, Nsw 2113

Australia

[74] Wenping Patent & Trade Mark Agent Limited

1701 Tung Wai Commercial Building,

111 Gloucester Road,

Hong Kong



---

[11] 2015495.9M007

[15] 24-01-2020

[30] 14-08-2019 / CN / 201930441842.4

[51] Cl. 13-03

[54] 開關

Switch

[73] SCHNEIDER ELECTRIC (AUSTRALIA) PTY LTD

78 Waterloo Road

Macquarie Park, Nsw 2113

Australia

[74] Wenping Patent & Trade Mark Agent Limited

1701 Tung Wai Commercial Building,

111 Gloucester Road,

Hong Kong



---

[11] 2015495.9M008

[15] 24-01-2020

[30] 14-08-2019 / CN / 201930441842.4

[51] Cl. 13-03

[54] 開關

Switch

[73] SCHNEIDER ELECTRIC (AUSTRALIA) PTY LTD

78 Waterloo Road

Macquarie Park, Nsw 2113

Australia

[74] Wenping Patent & Trade Mark Agent Limited

1701 Tung Wai Commercial Building,

111 Gloucester Road,

Hong Kong



- [11] 2015496.1  
[15] 24-01-2020  
[30] 04-09-2019 / CN / 201930486222.2  
[51] C1. 3-04  
[54] 風扇  
Fan  
[73] 深圳市同創創精密電子有限公司  
中國內地  
深圳市寶安區西鄉街道  
固戍社區西井路 21 號  
塘西第二工業區 A 區  
D 棟 301/401/501/701/整層  
[74] 金信智權有限公司  
香港觀塘  
偉業街 221 號  
美德工業大廈 D 座 10/F 38 室



- 
- [11] 2015497.3  
[15] 24-01-2020  
[30] 04-09-2019 / CN / 201930486222.2  
[51] C1. 3-04  
[54] 風扇  
Fan  
[73] 深圳市同創創精密電子有限公司  
中國內地  
深圳市寶安區西鄉街道  
固戍社區西井路 21 號  
塘西第二工業區 A 區  
D 棟 301/401/501/701/整層  
[74] 金信智權有限公司  
香港觀塘

偉業街 221 號

美德工業大廈 D 座 10/F 38 室



---

[11] 2015498.5M001

[15] 29-01-2020

[30] 30-07-2019 / NO, OM, SG, CH, TN, TR, UA, GB, EU, AL / DM/202  
792

[51] Cl. 10-02

[54] 手錶

Wristwatch

[73] SWATCH AG (SWATCH SA) (SWATCH LTD.)

Nicolas G. Hayek Strasse 1,  
2502 Biel/Bienne,  
Switzerland

[74] SPRUSON & FERGUSON (HONG KONG) LIMITED

5001 Hopewell Centre  
183 Queen's Road East,  
Wan Chai, Hong Kong



- [11] 2015498.5M002
- [15] 29-01-2020
- [30] 30-07-2019 / NO, OM, SG, CH, TN, TR, UA, GB, EU, AL / DM/202  
792
- [51] Cl. 10-02
- [54] 手錶  
Wristwatch
- [73] SWATCH AG (SWATCH SA) (SWATCH LTD.)  
Nicolas G. Hayek Strasse 1,  
2502 Biel/Bienne,  
Switzerland
- [74] SPRUSON & FERGUSON (HONG KONG) LIMITED  
5001 Hopewell Centre  
183 Queen's Road East,  
Wan Chai, Hong Kong



- 
- [11] 2015498.5M003
- [15] 29-01-2020
- [30] 30-07-2019 / NO, OM, SG, CH, TN, TR, UA, GB, EU, AL / DM/202  
792
- [51] Cl. 10-02
- [54] 手錶  
Wristwatch
- [73] SWATCH AG (SWATCH SA) (SWATCH LTD.)  
Nicolas G. Hayek Strasse 1,  
2502 Biel/Bienne,  
Switzerland
- [74] SPRUSON & FERGUSON (HONG KONG) LIMITED  
5001 Hopewell Centre  
183 Queen's Road East,  
Wan Chai, Hong Kong



---

[11] 2015498.5M004

[15] 29-01-2020

[30] 30-07-2019 / NO, OM, SG, CH, TN, TR, UA, GB, EU, AL / DM/202  
792

[51] Cl. 10-02

[54] 手錶

Wristwatch

[73] SWATCH AG (SWATCH SA) (SWATCH LTD.)

Nicolas G. Hayek Strasse 1,

2502 Biel/Bienne,

Switzerland

[74] SPRUSON & FERGUSON (HONG KONG) LIMITED

5001 Hopewell Centre

183 Queen's Road East,

Wan Chai, Hong Kong



---

[11] 2015498.5M005

[15] 29-01-2020

[30] 30-07-2019 / NO, OM, SG, CH, TN, TR, UA, GB, EU, AL / DM/202  
792

[51] Cl. 10-02

[54] 手錶

Wristwatch

[73] SWATCH AG (SWATCH SA) (SWATCH LTD.)

Nicolas G. Hayek Strasse 1,



2502 Biel/Bienne,  
Switzerland

- [74] SPRUSON & FERGUSON (HONG KONG) LIMITED  
5001 Hopewell Centre  
183 Queen's Road East,  
Wan Chai, Hong Kong



- 
- [11] 2015499.7M001  
[15] 29-01-2020  
[30] 02-09-2019 / CA, AM, AZ, BZ, BA, GE, LI, MK, MD, MC, MN, ME,  
MA, NO, OM, RU, SG, CH, TN, TR, UA, GB, EU, AL, KG / DM/203  
520  
[51] Cl. 11-01  
[54] 項鍊  
Necklace  
[73] Harry Winston SA  
Chemin du Tourbillon 8,  
CH-1228 Plan-les-Ouates,  
Switzerland  
[74] SPRUSON & FERGUSON (HONG KONG) LIMITED  
5001 Hopewell Centre  
183 Queen's Road East,  
Wan Chai, Hong Kong



- 
- [11] 2015499.7M002

- [15] 29-01-2020
- [30] 02-09-2019 / CA, AM, AZ, BZ, BA, GE, LI, MK, MD, MC, MN, ME, MA, NO, OM, RU, SG, CH, TN, TR, UA, GB, EU, AL, KG / DM/203 520
- [51] Cl. 11-01
- [54] 手鐲  
Bracelet
- [73] Harry Winston SA  
Chemin du Tourbillon 8,  
CH-1228 Plan-les-Ouates,  
Switzerland
- [74] SPRUSON & FERGUSON (HONG KONG) LIMITED  
5001 Hopewell Centre  
183 Queen's Road East,  
Wan Chai, Hong Kong



- 
- [11] 2015499.7M003
- [15] 29-01-2020
- [30] 02-09-2019 / CA, AM, AZ, BZ, BA, GE, LI, MK, MD, MC, MN, ME, MA, NO, OM, RU, SG, CH, TN, TR, UA, GB, EU, AL, KG / DM/203 520
- [51] Cl. 11-01
- [54] 耳環  
Earring
- [73] Harry Winston SA  
Chemin du Tourbillon 8,  
CH-1228 Plan-les-Ouates,  
Switzerland
- [74] SPRUSON & FERGUSON (HONG KONG) LIMITED  
5001 Hopewell Centre  
183 Queen's Road East,  
Wan Chai, Hong Kong



---

[11] 2015499.7M004

[15] 29-01-2020

[30] 02-09-2019 / CA, AM, AZ, BZ, BA, GE, LI, MK, MD, MC, MN, ME, MA, NO, OM, RU, SG, CH, TN, TR, UA, GB, EU, AL, KG / DM/203 520

[51] Cl. 11-01

[54] 項鍊

Necklace

[73] Harry Winston SA

Chemin du Tourbillon 8,  
CH-1228 Plan-les-Ouates,  
Switzerland

[74] SPRUSON & FERGUSON (HONG KONG) LIMITED

5001 Hopewell Centre  
183 Queen's Road East,  
Wan Chai, Hong Kong



---

[11] 2015499.7M005

[15] 29-01-2020

- [30] 02-09-2019 / CA, AM, AZ, BZ, BA, GE, LI, MK, MD, MC, MN, ME, MA, NO, OM, RU, SG, CH, TN, TR, UA, GB, EU, AL, KG / DM/203 520
- [51] Cl. 11-01
- [54] 耳環  
Earring
- [73] Harry Winston SA  
Chemin du Tourbillon 8,  
CH-1228 Plan-les-Ouates,  
Switzerland
- [74] SPRUSON & FERGUSON (HONG KONG) LIMITED  
5001 Hopewell Centre  
183 Queen's Road East,  
Wan Chai, Hong Kong



- 
- [11] 2015499.7M006
- [15] 29-01-2020
- [30] 02-09-2019 / CA, AM, AZ, BZ, BA, GE, LI, MK, MD, MC, MN, ME, MA, NO, OM, RU, SG, CH, TN, TR, UA, GB, EU, AL, KG / DM/203 520
- [51] Cl. 11-01
- [54] 耳環  
Earring
- [73] Harry Winston SA  
Chemin du Tourbillon 8,  
CH-1228 Plan-les-Ouates,  
Switzerland
- [74] SPRUSON & FERGUSON (HONG KONG) LIMITED  
5001 Hopewell Centre  
183 Queen's Road East,  
Wan Chai, Hong Kong



---

[11] 2015500.2

[15] 30-01-2020

[30] 08-08-2019 / CN / 201930430000.9

[51] Cl. 7-02

[54] 電磁爐

Induction cooker

[73] 北京小米移動軟件有限公司

Beijing Xiaomi Mobile Software Co., Ltd.

中國內地

北京市海澱區西二旗中路 33 號院

6 號樓 8 層 018 號

[74] 隆天專利商標代理有限公司

香港長沙灣

青山道 485 號

九龍廣場 10 樓 11 室

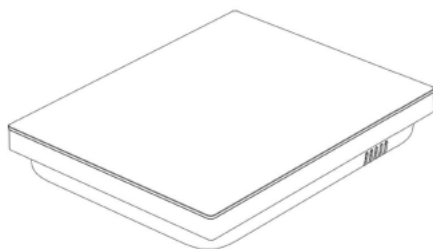

---

[11] 2015501.4

[15] 30-01-2020

- [30] 08-08-2019 / CN / 201930430560.4
- [51] Cl. 7-02
- [54] 電磁爐  
Induction cooker
- [73] 北京小米移動軟件有限公司  
Beijing Xiaomi Mobile Software Co., Ltd.  
中國內地  
北京市海澱區西二旗中路 33 號院  
6 號樓 8 層 018 號
- [74] 隆天專利商標代理有限公司  
香港長沙灣  
青山道 485 號  
九龍廣場 10 樓 11 室

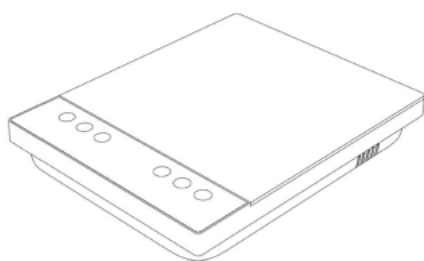

- 
- [11] 2015502.6M001
- [15] 30-01-2020
- [30] 29-08-2019 / EU / 006781803
- [51] Cl. 28-03
- [54] 剃鬚刀刀頭  
Head for shaver
- [73] Koninklijke Philips N.V.  
High Tech Campus 5,  
5656 AE Eindhoven,  
Netherlands
- [74] WILKINSON & GRIST  
6th Floor, Prince's Building,  
Chater Road,  
Hong Kong



---

[11] 2015502.6M002

[15] 30-01-2020

[30] 29-08-2019 / EU / 006781803

[51] Cl. 28-03

[54] 剃鬚刀刀頭

Head for shaver

[73] Koninklijke Philips N.V.

High Tech Campus 5,

5656 AE Eindhoven,

Netherlands

[74] WILKINSON & GRIST

6th Floor, Prince's Building,

Chater Road,

Hong Kong

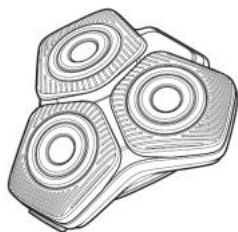

---

[11] 2015502.6M003

[15] 30-01-2020

[30] 29-08-2019 / EU / 006781803

[51] Cl. 28-03

[54] 剃鬚刀刀剪部件

Cutting unit for shaver

[73] Koninklijke Philips N.V.

High Tech Campus 5,

5656 AE Eindhoven,

Netherlands

[74] WILKINSON & GRIST  
6th Floor, Prince's Building,  
Chater Road,  
Hong Kong

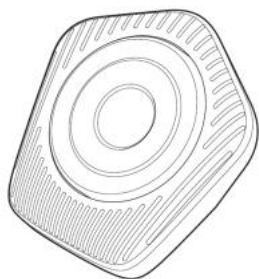

---

[11] 2015502.6M004

[15] 30-01-2020

[30] 29-08-2019 / EU / 006781803

[51] Cl. 28-03

[54] 剃鬚刀刀剪部件

Cutting unit for shaver

[73] Koninklijke Philips N.V.

High Tech Campus 5,

5656 AE Eindhoven,

Netherlands

[74] WILKINSON & GRIST

6th Floor, Prince's Building,

Chater Road,

Hong Kong



---

[11] 2015503.8

[15] 30-01-2020

[30] 29-07-2019 / US / 29/699,813

[51] Cl. 9-03



[54] 食品容器

Food container

[73] 祖美股份有限公司

ZUME, Inc.

250 Polaris Avenue Mountain View,

California 94043,

United States

[74] CHINAHONGKONG IP LIMITED

3011, 30/F, Office Tower,

Convention Plaza,

1 Harbour Road, Hong Kong



---

[11] 2015504.0

[15] 30-01-2020

[30] 29-07-2019 / US / 29/699,812

[51] Cl. 9-03

[54] 食品容器蓋

Lid for a food container

[73] 祖美股份有限公司

ZUME, Inc.

250 Polaris Avenue Mountain View,

California 94043,

United States

[74] CHINAHONGKONG IP LIMITED

3011, 30/F, Office Tower,

Convention Plaza,

1 Harbour Road, Hong Kong

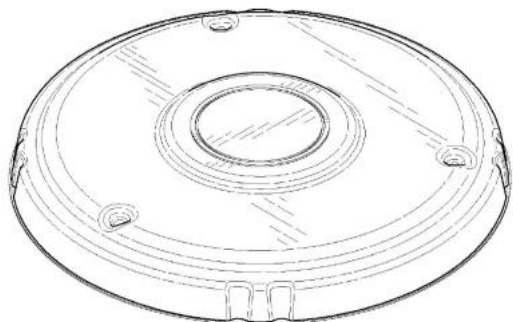

---

[11] 2015505.3

[15] 30-01-2020

[30] 05-08-2019 / CN / 201930421518.6

[51] Cl. 14-02

[54] 掃碼盒

Code scanning box

[73] Alibaba Group Holding Limited

Fourth Floor, One Capital Place, P.O. Box 847, George Town,  
Grand Cayman,  
Cayman Islands

[74] SPRUSON & FERGUSON (HONG KONG) LIMITED

5001 Hopewell Centre  
183 Queen's Road East,  
Wan Chai, Hong Kong



---

[11] 2015506.5M001

[15] 31-01-2020

[51] Cl. 3-01

[54] 行李箱

Luggage

[73] 新秀麗 IP 控股有限責任公司

Samsonite IP Holdings S.à r.l.

13-15 avenue de la Liberté,  
L-1931,  
Luxembourg

[74] WILKINSON & GRIST  
6th Floor, Prince's Building,  
Chater Road,  
Hong Kong

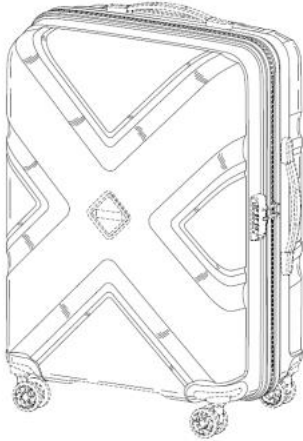

---

[11] 2015506.5M002

[15] 31-01-2020

[51] Cl. 3-01

[54] 行李箱  
Luggage

[73] 新秀麗 IP 控股有限責任公司  
Samsonite IP Holdings S.à r.l.  
13-15 avenue de la Liberté,  
L-1931,  
Luxembourg

[74] WILKINSON & GRIST  
6th Floor, Prince's Building,  
Chater Road,  
Hong Kong

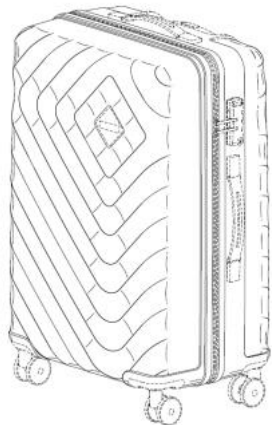

---

[11] 2015506.5M003

[15] 31-01-2020

[51] Cl. 3-01

[54] 行李箱  
Luggage

[73] 新秀麗 IP 控股有限責任公司  
Samsonite IP Holdings S.à r.l.  
13-15 avenue de la Liberté,  
L-1931,  
Luxembourg

[74] WILKINSON & GRIST  
6th Floor, Prince's Building,  
Chater Road,  
Hong Kong

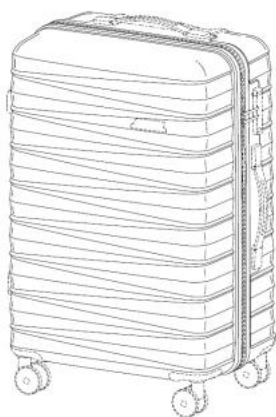

---

[11] 2015506.5M004

[15] 31-01-2020

[51] Cl. 3-01

[54] 行李箱

Luggage

[73] 新秀麗 IP 控股有限責任公司

Samsonite IP Holdings S.à r.l.

13-15 avenue de la Liberté,

L-1931,

Luxembourg

[74] WILKINSON & GRIST

6th Floor, Prince's Building,

Chater Road,

Hong Kong

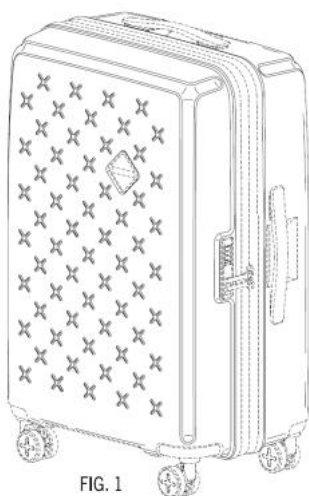

FIG. 1

---

[11] 2015506.5M005

[15] 31-01-2020

[51] Cl. 3-01

[54] 行李箱

Luggage

[73] 新秀麗 IP 控股有限責任公司

Samsonite IP Holdings S.à r.l.

13-15 avenue de la Liberté,

L-1931,

Luxembourg

[74] WILKINSON & GRIST

6th Floor, Prince's Building,

Chater Road,

Hong Kong

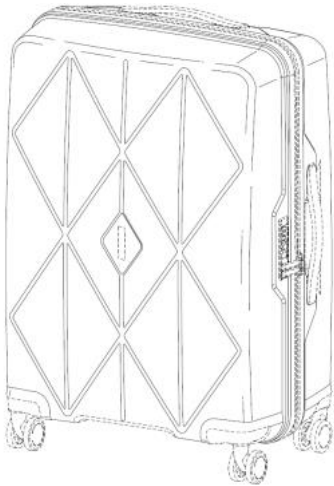

[11] 2015507.7

[15] 31-01-2020

[30] 07-10-2019 / AM, AZ, BZ, BA, GE, LI, MK, MD, MC, MN, ME, MA,  
NO, OM, RU, SG, CH, TN, TR, UA, GB, EU, AL, KG / DM/204 145

[51] Cl. 10-07

[54] 錶殼

Watch case

[73] BLANCPAIN SA

Le Rocher 12,

CH-1348 LE BRASSUS,

Switzerland

[74] SPRUSON & FERGUSON (HONG KONG) LIMITED

5001 Hopewell Centre

183 Queen's Road East,

Wan Chai, Hong Kong



- [11] 2015508.9M001  
[15] 31-01-2020  
[30] 05-08-2019 / CN / 201930421679.5  
[51] Cl. 14-02  
[54] 帶屏幕的收銀設備  
Payment device with screen  
[73] Alibaba Group Holding Limited  
Fourth Floor, One Capital Place, P.O. Box 847,  
George Town, Grand Cayman,  
Cayman Islands  
[74] SPRUSON & FERGUSON (HONG KONG) LIMITED  
5001 Hopewell Centre  
183 Queen's Road East,  
Wan Chai, Hong Kong

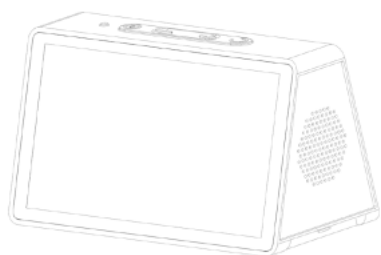

- 
- [11] 2015508.9M002  
[15] 31-01-2020  
[30] 05-08-2019 / CN / 201930421679.5  
[51] Cl. 14-02  
[54] 帶屏幕的收銀設備  
Payment device with screen  
[73] Alibaba Group Holding Limited  
Fourth Floor, One Capital Place, P.O. Box 847,  
George Town, Grand Cayman,  
Cayman Islands  
[74] SPRUSON & FERGUSON (HONG KONG) LIMITED  
5001 Hopewell Centre  
183 Queen's Road East,  
Wan Chai, Hong Kong

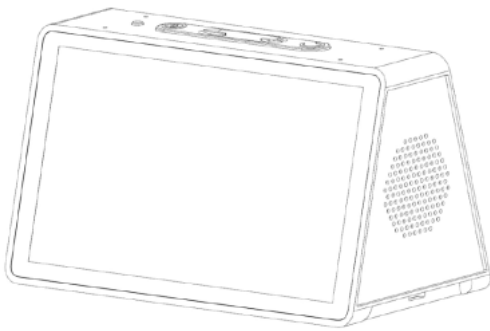

---

[11] 2015508.9M003

[15] 31-01-2020

[30] 05-08-2019 / CN / 201930421679.5

[51] Cl. 14-02

[54] 帶屏幕的收銀設備

Payment device with screen

[73] Alibaba Group Holding Limited

Fourth Floor, One Capital Place, P.O. Box 847,

George Town, Grand Cayman,

Cayman Islands

[74] SPRUSON & FERGUSON (HONG KONG) LIMITED

5001 Hopewell Centre

183 Queen's Road East,

Wan Chai, Hong Kong

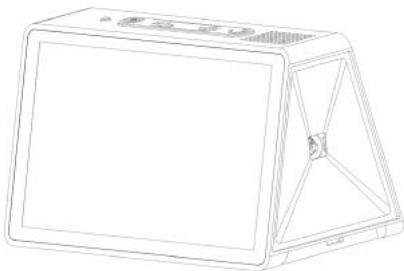

---

[11] 2015510.3M001

[15] 31-01-2020

[51] Cl. 11-01

[54] 首飾

Jewellery

[73] TASAKI & Co., Ltd.

3-2, 6-chome, Minatojima Naka-machi,



Chuo-ku, Kobe 650-0046,  
Japan

[74] DEACONS  
5th Floor, Alexandra House  
Central,  
Hong Kong

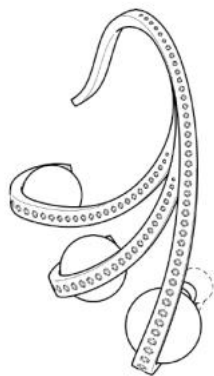

---

[11] 2015510.3M002

[15] 31-01-2020

[51] Cl. 11-01

[54] 首飾  
Jewellery

[73] TASAKI & Co., Ltd.  
3-2, 6-chome, Minatojima Naka-machi,  
Chuo-ku, Kobe 650-0046,  
Japan

[74] DEACONS  
5th Floor, Alexandra House  
Central,  
Hong Kong



[11] 2015510.3M003

[15] 31-01-2020

[51] Cl. 11-01

[54] 首飾

Jewellery

[73] TASAKI & Co., Ltd.

3-2, 6-chome, Minatojima Naka-machi,

Chuo-ku, Kobe 650-0046,

Japan

[74] DEACONS

5th Floor, Alexandra House

Central,

Hong Kong

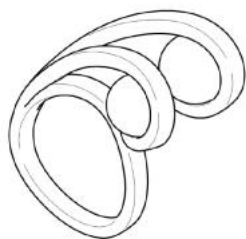

---

[11] 2015510.3M004

[15] 31-01-2020

[51] Cl. 11-01

[54] 首飾

Jewellery

[73] TASAKI & Co., Ltd.

3-2, 6-chome, Minatojima Naka-machi,

Chuo-ku, Kobe 650-0046,

Japan

[74] DEACONS

5th Floor, Alexandra House

Central,

Hong Kong

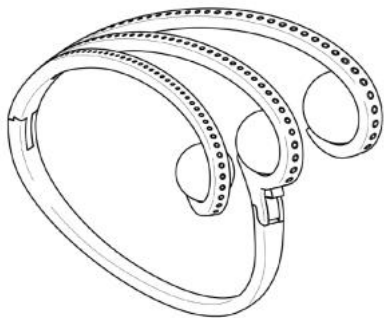

---

[11] 2015510.3M005

[15] 31-01-2020

[51] Cl. 11-01

[54] 首飾  
Jewellery

[73] TAsAKI & Co., Ltd.  
3-2, 6-chome, Minatojima Naka-machi,  
Chuo-ku, Kobe 650-0046,  
Japan

[74] DEACONS  
5th Floor, Alexandra House  
Central,  
Hong Kong

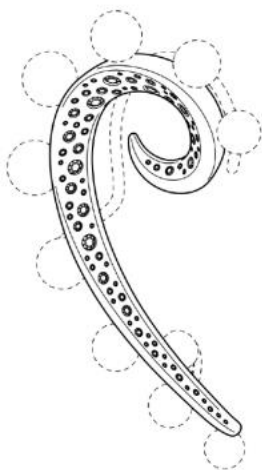

---

[11] 2015510.3M006

[15] 31-01-2020

[51] Cl. 11-01

[54] 首飾

Jewellery

[73] TASAKI & Co., Ltd.

3-2, 6-chome, Minatojima Naka-machi,  
Chuo-ku, Kobe 650-0046,  
Japan

[74] DEACONS

5th Floor, Alexandra House  
Central,  
Hong Kong

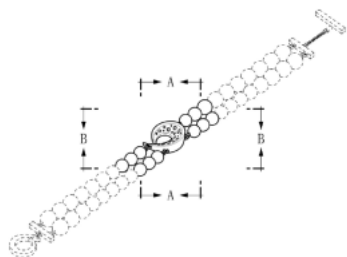

---

[11] 2015510.3M007

[15] 31-01-2020

[51] Cl. 11-01

[54] 首飾

Jewellery

[73] TASAKI & Co., Ltd.

3-2, 6-chome, Minatojima Naka-machi,  
Chuo-ku, Kobe 650-0046,  
Japan

[74] DEACONS

5th Floor, Alexandra House  
Central,  
Hong Kong

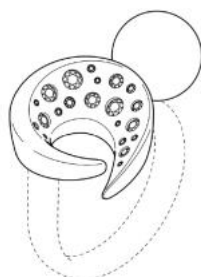

- [11] 2015512.7M001  
[15] 31-01-2020  
[30] 06-11-2019 / EU / 007189253-0003  
[51] Cl. 3-01  
[54] 流動電話外殼  
Case for mobile telephones  
[73] RIMOWA GmbH  
Richard-Byrd-Strasse 13,  
Cologne, 50829,  
Germany  
[74] ROBIN BRIDGE & JOHN LIU  
6th Floor, Emperor Commercial Centre,  
39 Des Voeux Road Central,  
Hong Kong



- 
- [11] 2015512.7M002  
[15] 31-01-2020  
[30] 06-11-2019 / EU / 007189303-0003  
[51] Cl. 3-01  
[54] 流動電話外殼  
Case for mobile telephones  
[73] RIMOWA GmbH  
Richard-Byrd-Strasse 13,  
Cologne, 50829,  
Germany  
[74] ROBIN BRIDGE & JOHN LIU  
6th Floor, Emperor Commercial Centre,  
39 Des Voeux Road Central,  
Hong Kong



- 
- [11] 2015513.9  
[15] 31-01-2020  
[30] 04-09-2019 / JP / 019708 of 2019  
[51] Cl. 12-16  
[54] 用於汽車煞車鼓器的鼓蓋  
Drum cover for drum brake of automobile  
[73] Kabushiki Kaisha Moonface (Moonface, Inc.)  
24 Nishiarai, Jojo-cho, Anjo-shi,  
Aichi-ken 446-0023,  
Japan  
[74] P C WOO & CO  
Room 1225, 12/F., Prince's Building,  
10 Chater Road,  
Central, Hong Kong

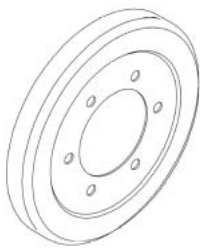

- 
- [11] 2015514.1M001  
[15] 31-01-2020  
[30] 10-09-2019 / CA, AM, AZ, BZ, BA, GE, LI, MK, MD, MC, MN, ME,  
MA, NO, OM, RU, SG, CH, TN, TR, UA, GB, EU, AL, KG / DM/203  
260  
[51] Cl. 11-01

[54] 指環  
Ring

[73] Harry Winston SA  
Chemin du Tourbillon 8,  
CH-1228 Plan-les-Ouates,  
Switzerland

[74] SPRUSON & FERGUSON (HONG KONG) LIMITED  
5001 Hopewell Centre  
183 Queen's Road East,  
Wan Chai, Hong Kong



---

[11] 2015514.1M002

[15] 31-01-2020

[30] 10-09-2019 / CA, AM, AZ, BZ, BA, GE, LI, MK, MD, MC, MN, ME,  
MA, NO, OM, RU, SG, CH, TN, TR, UA, GB, EU, AL, KG / DM/203  
260

[51] Cl. 11-01

[54] 指環  
Ring

[73] Harry Winston SA  
Chemin du Tourbillon 8,  
CH-1228 Plan-les-Ouates,  
Switzerland

[74] SPRUSON & FERGUSON (HONG KONG) LIMITED  
5001 Hopewell Centre  
183 Queen's Road East,  
Wan Chai, Hong Kong



---

[11] 2015515.4M001

[15] 31-01-2020

[51] Cl. 11-01

[54] 珠寶的裝飾元件

Decorative element of jewellery

[73] VAN CLEEF & ARPELS SA

Route des Biches 8,  
1752 Villars-sur-Glâne,  
Switzerland

[74] UNION PATENT SERVICE CENTRE

Units E-F, 20th Floor, Neich Tower,  
128 Gloucester Road,  
Hong Kong

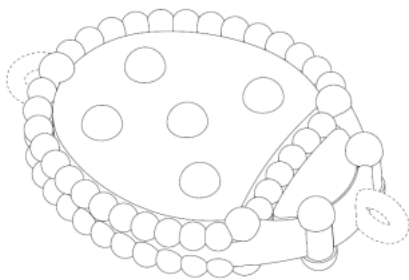

---

[11] 2015515.4M002

[15] 31-01-2020

[51] Cl. 11-01

[54] 珠寶的裝飾元件

Decorative element of jewellery



[73] VAN CLEEF & ARPELS SA  
Route des Biches 8,  
1752 Villars-sur-Glâne,  
Switzerland

[74] UNION PATENT SERVICE CENTRE  
Units E-F, 20th Floor, Neich Tower,  
128 Gloucester Road,  
Hong Kong

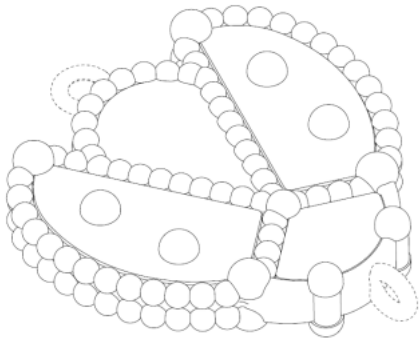

---

[11] 2015516.6M001

[15] 02-02-2020

[30] 02-08-2019 / MC, SG, CH, TR, UA, GB, EU / DM/202 832

[51] Cl. 11-01

[54] 項鍊

Necklace

[73] Chaumet International S.A.  
12, Place Vendôme,  
75001 Paris,  
France

[74] UNION PATENT SERVICE CENTRE  
Units E-F, 20th Floor, Neich Tower,  
128 Gloucester Road,  
Hong Kong



[11] 2015516.6M002

[15] 02-02-2020

[30] 02-08-2019 / MC, SG, CH, TR, UA, GB, EU / DM/202 832

[51] Cl. 11-01

[54] 戒指

Finger ring

[73] Chaumet International S.A.

12, Place Vendôme,

75001 Paris,

France

[74] UNION PATENT SERVICE CENTRE

Units E-F, 20th Floor, Neich Tower,

128 Gloucester Road,

Hong Kong



---

[11] 2015516.6M003

[15] 02-02-2020

[30] 02-08-2019 / MC, SG, CH, TR, UA, GB, EU / DM/202 832

[51] Cl. 11-01

[54] 耳環

Earring

[73] Chaumet International S.A.

12, Place Vendôme,

75001 Paris,

France

[74] UNION PATENT SERVICE CENTRE

Units E-F, 20th Floor, Neich Tower,

128 Gloucester Road,

Hong Kong



---

[11] 2015516.6M004

[15] 02-02-2020

[30] 02-08-2019 / MC, SG, CH, TR, UA, GB, EU / DM/202 832

[51] Cl. 11-01

[54] 耳環

Earring

[73] Chaumet International S.A.

12, Place Vendôme,

75001 Paris,

France

[74] UNION PATENT SERVICE CENTRE

Units E-F, 20th Floor, Neich Tower,

128 Gloucester Road,

Hong Kong



---

[11] 2015516.6M005

[15] 02-02-2020

[30] 02-08-2019 / MC, SG, CH, TR, UA, GB, EU / DM/202 832

[51] Cl. 11-01

[54] 項鍊

Necklace

[73] Chaumet International S.A.

12, Place Vendôme,

75001 Paris,  
France

[74] UNION PATENT SERVICE CENTRE  
Units E-F, 20th Floor, Neich Tower,  
128 Gloucester Road,  
Hong Kong



---

[11] 2015516.6M006

[15] 02-02-2020

[30] 02-08-2019 / MC, SG, CH, TR, UA, GB, EU / DM/202 832

[51] Cl. 11-01

[54] 項鍊

Necklace

[73] Chaumet International S.A.  
12, Place Vendôme,  
75001 Paris,  
France

[74] UNION PATENT SERVICE CENTRE  
Units E-F, 20th Floor, Neich Tower,  
128 Gloucester Road,  
Hong Kong



---

[11] 2015516.6M007

[15] 02-02-2020

[30] 02-08-2019 / MC, SG, CH, TR, UA, GB, EU / DM/202 832

[51] Cl. 11-01

[54] 項鍊

Necklace

[73] Chaumet International S.A.

12, Place Vendôme,

75001 Paris,

France

[74] UNION PATENT SERVICE CENTRE

Units E-F, 20th Floor, Neich Tower,

128 Gloucester Road,

Hong Kong



---

[11] 2015517.8M001

[15] 03-02-2020

[51] Cl. 7-04

[54] 拉動式食物料理機

A pull-out type food processor

[73] 汪恩光

WONG Yan Kwong

Unit 403-404, 4/F., Po Lung Centre

11 Wang Chiu Road,

Kowloon Bay, Kowloon

Hong Kong

貝印刃物中心

Kai R&D Center Co. , Ltd.

1110 Oyana, Seki-shi,

Gifu, 501-3992,

Japan

[74] FEDERATION OF HONG KONG INDUSTRIES

31/F, Billion Plaza,

8 Cheung Yue Street,

Cheung Sha Wan, Kowloon

Hong Kong



---

[11] 2015517.8M002

[15] 03-02-2020

[51] Cl. 7-04

[54] 拉動式食物料理機

A pull-out type food processor

[73] 汪恩光

WONG Yan Kwong

Unit 403-404, 4/F., Po Lung Centre

11 Wang Chiu Road,

Kowloon Bay, Kowloon

Hong Kong

貝印刃物中心

Kai R&D Center Co. , Ltd.

1110 Oyana, Seki-shi,

Gifu, 501-3992,

Japan

[74] FEDERATION OF HONG KONG INDUSTRIES

31/F, Billion Plaza,

8 Cheung Yue Street,

Cheung Sha Wan, Kowloon

Hong Kong

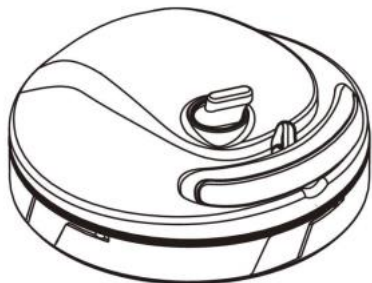

---

[11] 2015518.0

[15] 03-02-2020

[30] 27-09-2019 / EU / 006937835-0001

[51] Cl. 3-01

[54] 手袋

Handbag

[73] DELVAUX CREATEUR SA

Boulevard Louis Schmidt 7,

B-1040 Bruxelles,

Belgium

[74] ALAN & ASSOCIATES (HONG KONG) INTELLECTUAL PROPERTY AGENCY LTD

Unit A, 25/F, United Centre,

No. 95 Queensway,

Hong Kong



---

[11] 2015519.2M001

[15] 03-02-2020

[51] Cl. 11-01

[54] 首飾

Jewellery

[73] Master Dynamic Limited

Unit 103, 1/F, Lakeside 2 (Building 10W),

Phase 2, Hong Kong Science Park,

Pak Shek Kok, New Territories,

Hong Kong

[74] LETTERS & THOO LIMITED

Suite 1008, Prosperity Millennia Plaza,

663 King's Road,

Quarry Bay, Hong Kong

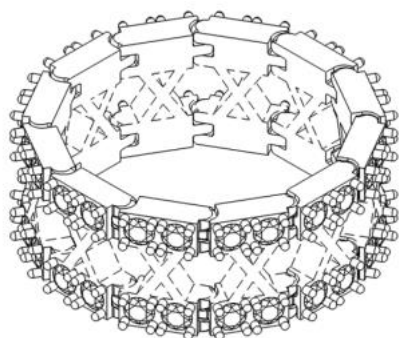

---

[11] 2015519.2M002

[15] 03-02-2020

[51] Cl. 11-01

[54] 首飾

Jewellery

[73] Master Dynamic Limited

Unit 103, 1/F, Lakeside 2 (Building 10W),  
Phase 2, Hong Kong Science Park,  
Pak Shek Kok, New Territories,  
Hong Kong

[74] LETTERS & THOO LIMITED

Suite 1008, Prosperity Millennia Plaza,  
663 King's Road,  
Quarry Bay, Hong Kong

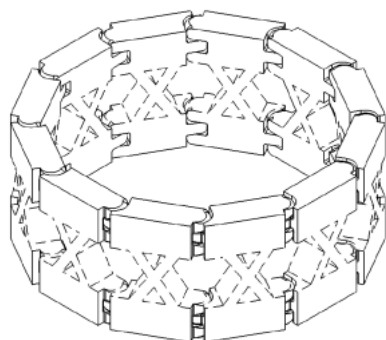

---

[11] 2015519.2M003

[15] 03-02-2020

[51] Cl. 11-01

[54] 首飾

Jewellery

[73] Master Dynamic Limited

Unit 103, 1/F, Lakeside 2 (Building 10W),  
Phase 2, Hong Kong Science Park,



Pak Shek Kok, New Territories,  
Hong Kong

- [74] LETTERS & THOO LIMITED  
Suite 1008, Prosperity Millennia Plaza,  
663 King's Road,  
Quarry Bay, Hong Kong

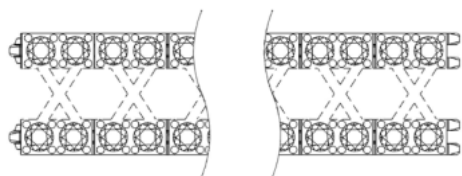

- 
- [11] 2015519.2M004  
[15] 03-02-2020  
[51] Cl. 11-01  
[54] 首飾  
Jewellery  
[73] Master Dynamic Limited  
Unit 103, 1/F, Lakeside 2 (Building 10W),  
Phase 2, Hong Kong Science Park,  
Pak Shek Kok, New Territories,  
Hong Kong  
[74] LETTERS & THOO LIMITED  
Suite 1008, Prosperity Millennia Plaza,  
663 King's Road,  
Quarry Bay, Hong Kong

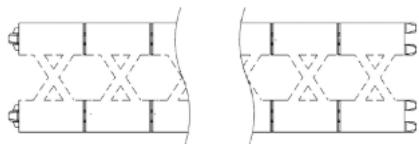

- 
- [11] 2015524.2M001  
[15] 04-02-2020  
[30] 13-08-2019 / CN / 201930439234.X  
[51] Cl. 10-06  
[54] 門鈴  
Doorbell  
[73] 北京小米移動軟件有限公司  
BEIJING XIAOMI MOBILE SOFTWARE CO., LTD.  
中國內地

北京市海澱區西二旗中路  
33 號院 6 號樓 8 層 018 號

- [74] 香港派特恩知識產權代理有限公司  
香港上環  
永樂街 121-125 號  
永達商業大廈 10 樓 C 室

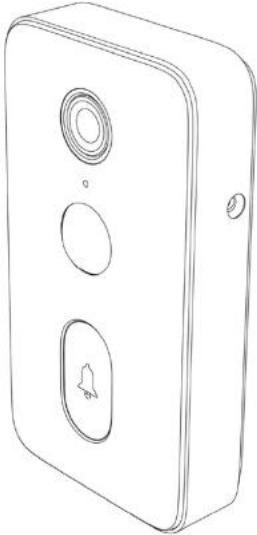

- 
- [11] 2015524.2M002  
[15] 04-02-2020  
[30] 13-08-2019 / CN / 201930439234.X  
[51] Cl. 10-06  
[54] 門鈴  
Doorbell  
[73] 北京小米移動軟件有限公司  
BEIJING XIAOMI MOBILE SOFTWARE CO., LTD.  
中國內地  
北京市海澱區西二旗中路  
33 號院 6 號樓 8 層 018 號  
[74] 香港派特恩知識產權代理有限公司  
香港上環  
永樂街 121-125 號  
永達商業大廈 10 樓 C 室

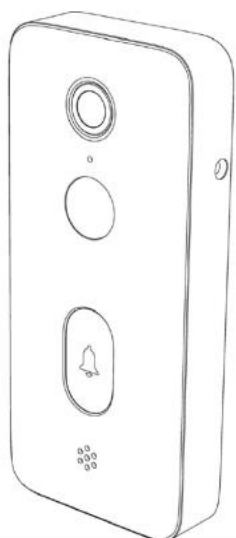

---

[11] 2015525.5

[15] 04-02-2020

[30] 13-08-2019 / CN / 201930439215.7

[51] C1. 10-06

[54] 門鈴接收器

Doorbell receiver

[73] 北京小米移動軟件有限公司

BEIJING XIAOMI MOBILE SOFTWARE CO., LTD.

中國內地

北京市海澱區西二旗中路

33 號院 6 號樓 8 層 018 號

[74] 香港派特恩知識產權代理有限公司

香港上環

永樂街 121-125 號

永達商業大廈 10 樓 C 室

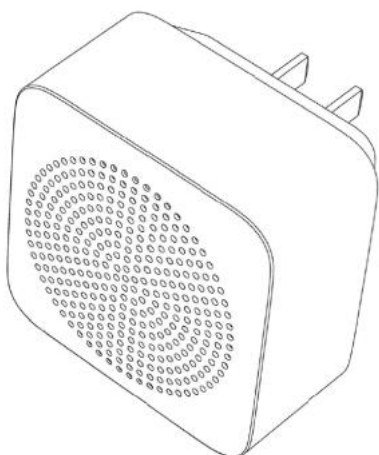





香港特別行政區政府知識產權署外觀設計註冊處

The Government of the Hong Kong Special Administrative Region

Designs Registry, Intellectual Property Department

根據註冊外觀設計條例第 28 條，下列註冊外觀設計因未繳續期費而停止有效。

各組記項按註冊外觀設計停止有效日期及註冊編號先後次序排列。

**Registered designs ceased through non-payment of renewal fees under section 28 of the Registered Designs Ordinance. Entries are listed below under their expiry dates.**

**01-05-2020 - 06-05-2020**

<b>01-05-2020</b>	1500985.5M001	1000839.1M002
0010539.5M001	1500985.5M002	1000839.1M004
	1500986.7	1000839.1M005
<b>02-05-2020</b>	1500987.9	1000839.1M006
1000797.1	1500988.1	1000841.5
1000799.5	1500989.3	1000842.7
1000803.5	1500991.7M001	1000843.9
1000804.7	1500991.7M002	1000844.1
1000807.4	1500992.9M001	1000845.4
1000808.6	1500992.9M002	1000846.6
1000809.8	1500993.1	1000847.8
	1500994.3M001	1501001.0
<b>03-05-2020</b>	1500994.3M002	1501002.2
0501018.4	1500996.8	1501004.6M001
1000812.4		1501004.6M002
1000813.6	<b>05-05-2020</b>	1501004.6M003
1500976.6M001	1000832.6	1501005.9
1500976.6M002	1000834.0M001	
1500976.6M003	1000834.0M002	
1500977.8	1500997.0M001	
1500978.0M001	1500997.0M002	
1500978.0M002	1500999.4	
1500978.0M003	1501000.8M001	
1500979.2M001	1501000.8M002	
<b>04-05-2020</b>	<b>06-05-2020</b>	
1000822.5	0501054.9M002	
1500979.2M002	0501054.9M004	
1500979.2M003	0501054.9M005	
1500979.2M004	0501054.9M006	
1500980.4	0501054.9M007	
1500981.6	0501054.9M008	
1500982.8	0501054.9M009	
1500983.0	1000839.1M001	



香港特別行政區政府知識產權署外觀設計註冊處

The Government of the Hong Kong Special Administrative Region

Designs Registry, Intellectual Property Department

根據註冊外觀設計規則第 31 條刪除的註冊外觀設計。各組記項按註冊外觀設計刪除日期及註冊編號先後次序排列。

**Registered designs removed under section 31 of the Registered Designs Rules. Entries are listed below under their removal dates.**

**12-06-2020 - 18-06-2020****12-06-2020**

0412492.9M001	0412522.5
0412492.9M002	0901836.3M001
0412495.6M003	1402050.3
0412495.6M004	1402052.7

0412495.6M005

**15-06-2020**

0412495.6M006 1402053.9

0412495.6M007

0412495.6M008

**16-06-2020**

0412496.8M001 0412531.4M003

0412496.8M002 0412531.4M004

0412496.8M003 0412531.4M005

0412496.8M004 0412532.6M002

0412496.8M005 0901844.9M001

0412496.8M006 0901844.9M003

0412497.0M002 1402058.0M001

0412497.0M003 1402058.0M003

0412497.0M004 1402059.2

0412506.2M002 1402061.6

0412506.2M003

0412506.2M004

**17-06-2020**

0412506.2M005 1402068.1

0412506.2M006 1402070.5

0500171.6M001 1402071.7

0500171.6M002 1402072.9M001

0500173.0M001 1402072.9M002

0500173.0M002

1402044.0

**18-06-2020**

1402045.3 1402075.6

1402046.5

1402048.9

**14-06-2020**

0412514.8