

# 香港知識產權公報

Hong Kong Intellectual Property Journal

2021 年 11 月 5 日  
05 November 2021

## 目錄 Contents

### 根據註冊外觀設計條例第 25 條註冊的外觀設計

#### **Designs Registered under section 25 of the Registered Designs Ordinance**

按註冊編號排列

Arranged by Registration Number

### 根據註冊外觀設計條例(第 522 章)公布的其他公告

#### **Other Notices Published under the Registered Designs Ordinance (Cap. 522)**

根據註冊外觀設計條例第 28 條，註冊外觀設計因未繳續期費而停止有效

Registered designs ceased through non-payment of renewal fees under section 28 of the Registered Designs Ordinance

根據註冊外觀設計規則第 31 條刪除的註冊外觀設計

Registered designs removed under section 31 of the Registered Designs Rules

### 以下事項沒有記錄

#### **No Records for the Following Matters**

根據註冊外觀設計條例第 30 條放棄的外觀設計的註冊

Surrender of Registration of Design under section 30 of the Registered Designs Ordinance

根據註冊外觀設計規則第 37 條，向處長作出轉介

Reference to Registrar under section 37 of the Registered Designs Rules

根據註冊外觀設計條例第 45 條，撤銷註冊

Revocation of Registration under section 45 of the Registered Designs Ordinance

根據註冊外觀設計規則第 46 條，向法院作出轉介

Reference to Court under section 46 of the Registered Designs Rules

根據註冊外觀設計規則第 63 條對不符合規定之處作出糾正

Rectification of Irregularities under section 63 of the Registered Designs Rules

根據註冊外觀設計條例第 66 條，糾正註冊紀錄冊

Rectification of Register under section 66 of the Registered Designs Ordinance

根據註冊外觀設計條例第 67 條 更正註冊紀錄冊內的錯誤

Correction of errors in Register under section 67 of the Registered Designs Ordinance

根據註冊外觀設計條例第 67 及 76 條，更正註冊紀錄冊內及已提交文件中的錯誤

Correction of Errors in Register and in Filed Documents under sections 67 and 76 of the Registered Designs Ordinance

根據註冊外觀設計條例第 76 條，更正已提交文件中的錯誤

Correction of errors in filed documents under section 76 of the Registered Designs Ordinance

勘誤

Corrigendum

## 註冊外觀設計公告註釋

### Notes on advertisements of registration of designs

方括號表示下列資料：

Square brackets indicate the following data：

[11] 註冊編號 Registration number / 聯合王國註冊編號 United Kingdom registration number

[15] 註冊日期 Registration date / 當作註冊日期 Deemed registration date / 聯合王國註冊日期 United Kingdom registration date

[17] 註冊有效期屆滿日期 Expiry date of the period of registration

[22] 提交日期 Filing date / 當作提交日期 Deemed filing date / 聯合王國提交日期 United Kingdom filing date

[30] 聲稱享有的優先權（提交日期 / 巴黎公約國或世界貿易組織成員 / 申請編號） Priority claimed (filing date / Paris Convention country or WTO member / application number)

[51] 國際外觀設計分類號（洛迦諾分類號） International Classification of designs (Locarno Classification)

[54] 物品 Article

[55] 外觀設計的表述 Representation of the design

[62] 分開前的申請編號及提交日期 Application number before division and filing date

[66] 過往註冊的聯繫外觀設計註冊編號 / 日期 Registration No. / Date of Previous Registration for Association

[72] 設計人 Designer

[73] 擁有人姓名和地址 Name and address of the owner

[74] 代理人 Agent /送達地址 Address for service



香港特別行政區政府知識產權署外觀設計註冊處

The Government of the Hong Kong Special Administrative Region

Designs Registry, Intellectual Property Department

## 根據註冊外觀設計條例第 25 條註冊的外觀設計

### Designs registered under section 25 of the Registered Designs Ordinance

按註冊編號排列

Arranged by Registration Number

[11] 2117916.7M001

[15] 27-04-2021

[30] 05-11-2020 / JP / 023854 of 2020

[51] Cl. 21-01

[54] 遊戲機

Game device

[73] Kabushiki Kaisha Bandai (Bandai Co., Ltd.)

4-8, Komagata 1-chome,

Taito-ku, Tokyo,

Japan

[74] SIMMONS & SIMMONS

30th Floor, One Taikoo Place,

979 King's Road,

Hong Kong

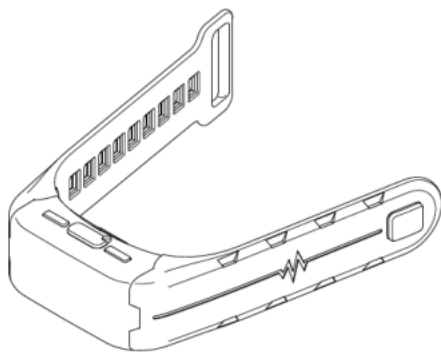

---

[11] 2117916.7M002

[15] 27-04-2021

[30] 05-11-2020 / JP / 023855 of 2020

[51] Cl. 21-01

- [54] 用於遊戲機的記錄媒體  
Record medium for game device
- [73] Kabushiki Kaisha Bandai (Bandai Co., Ltd.)  
4-8, Komagata 1-chome,  
Taito-ku, Tokyo,  
Japan
- [74] SIMMONS & SIMMONS  
30th Floor, One Taikoo Place,  
979 King's Road,  
Hong Kong

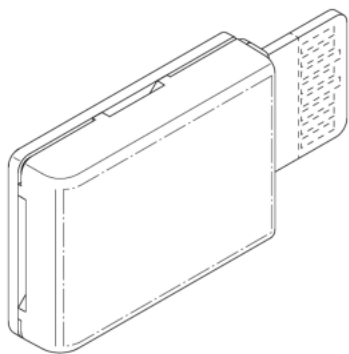

- 
- [11] 2117916.7M003
- [15] 27-04-2021
- [30] 02-12-2020 / JP / 025938 of 2020
- [51] Cl. 21-01
- [54] 用於遊戲機的帶固定板的記錄媒體  
Record medium with holding plate for game device
- [73] Kabushiki Kaisha Bandai (Bandai Co., Ltd.)  
4-8, Komagata 1-chome,  
Taito-ku, Tokyo,  
Japan
- [74] SIMMONS & SIMMONS  
30th Floor, One Taikoo Place,  
979 King's Road,  
Hong Kong

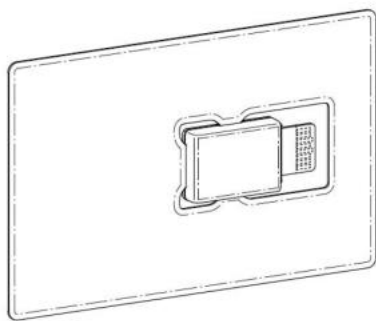

---

[11] 2118341.7

[15] 16-07-2021

[30] 18-01-2021 / CN / 202130034668.9

[51] Cl. 14-02

[54] 顯示器  
Monitor

[73] 北京小米移動軟件有限公司  
BEIJING XIAOMI MOBILE SOFTWARE CO., LTD.  
中國內地  
北京市海澱區西二旗中路 33 號院  
6 號樓 8 層 018 號

[74] 香港派特恩知識產權代理有限公司  
香港上環  
永樂街 121-125 號  
永達商業大廈 10 樓 C 室

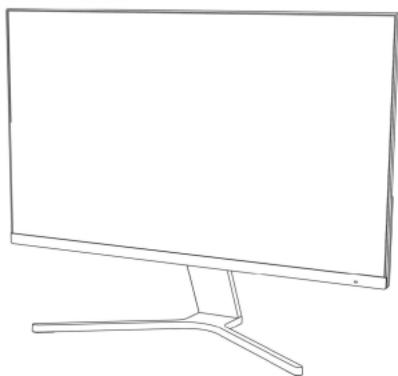

---

[11] 2118346.8

[15] 19-07-2021

[30] 19-01-2021 / CN / 202130037417.6



- [51] Cl. 15-05
- [54] 智能掃地機器人  
Intelligent sweeping robot
- [73] 北京小米移動軟件有限公司  
BEIJING XIAOMI MOBILE SOFTWARE CO., LTD.  
中國內地  
北京市海澱區西二旗中路 33 號院  
6 號樓 8 層 018 號
- [74] 香港派特恩知識產權代理有限公司  
香港上環  
永樂街 121-125 號  
永達商業大廈 10 樓 C 室



- 
- [11] 2118347.0
- [15] 19-07-2021
- [30] 19-01-2021 / CN / 202130037715.5
- [51] Cl. 15-05
- [54] 智能掃地機器人  
Intelligent sweeping robot
- [73] 北京小米移動軟件有限公司  
BEIJING XIAOMI MOBILE SOFTWARE CO., LTD.  
中國內地  
北京市海澱區西二旗中路 33 號院  
6 號樓 8 層 018 號
- [74] 香港派特恩知識產權代理有限公司  
香港上環  
永樂街 121-125 號  
永達商業大廈 10 樓 C 室

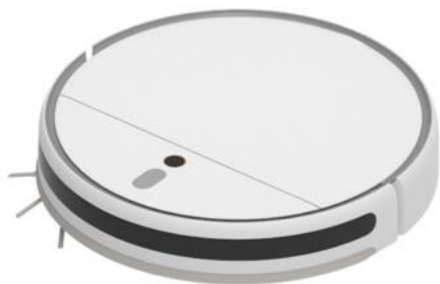

---

[11] 2118350.6

[15] 19-07-2021

[30] 22-01-2021 / US / 29/767,422

[51] Cl. 6-11

[54] 地墊安裝面板

Installation panel for mats

[73] New Pig Corporation

One Pork Avenue,

P.O. BOX 304,

Tipton, Pennsylvania 16684,

United States of America

[74] SPRUSON & FERGUSON (HONG KONG) LIMITED

5001 Hopewell Centre,

183 Queen's Road East,

Wan Chai, Hong Kong

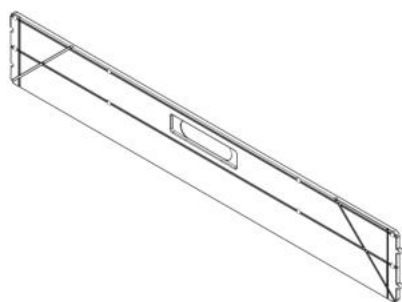

---

[11] 2118355.7M001

[15] 20-07-2021

[30] 20-01-2021 / EU / 008409296-0003

[51] Cl. 28-03

[54] 剃鬚器

Shaver

[73] Koninklijke Philips N.V.  
High Tech Campus 52,  
5656 AG Eindhoven,  
Netherlands

[74] Rouse & Co. International (Overseas) Limited  
26/F., Tesbury Centre,  
28 Queen's Road East,  
Hong Kong



---

[11] 2118355.7M002

[15] 20-07-2021

[30] 20-01-2021 / EU / 008409296-0007

[51] Cl. 28-03

[54] 剃鬚器手柄

Handle for shaver

[73] Koninklijke Philips N.V.  
High Tech Campus 52,  
5656 AG Eindhoven,  
Netherlands

[74] Rouse & Co. International (Overseas) Limited  
26/F., Tesbury Centre,  
28 Queen's Road East,  
Hong Kong

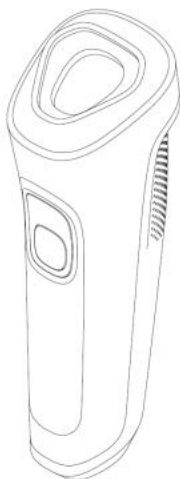

---

[11] 2118356.9M001

[15] 20-07-2021

[30] 20-01-2021 / EU / 008409361-0001

[51] Cl. 28-03

[54] 風筒

Hairdryer

[73] Koninklijke Philips N.V.

High Tech Campus 52,

5656 AG Eindhoven,

Netherlands

[74] Rouse & Co. International (Overseas) Limited

26/F., Tesbury Centre,

28 Queen's Road East,

Hong Kong

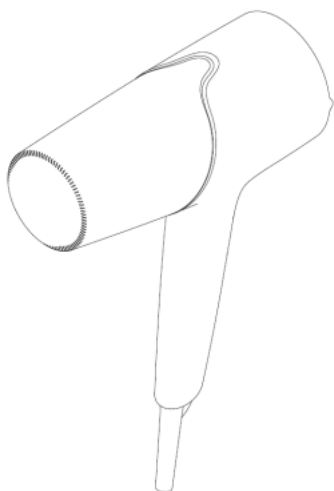

- [11] 2118356.9M002  
[15] 20-07-2021  
[30] 20-01-2021 / EU / 008409361-0004  
[51] Cl. 28-03  
[54] 風筒  
Hairdryer  
[73] Koninklijke Philips N.V.  
High Tech Campus 52,  
5656 AG Eindhoven,  
Netherlands  
[74] Rouse & Co. International (Overseas) Limited  
26/F., Tesbury Centre,  
28 Queen's Road East,  
Hong Kong

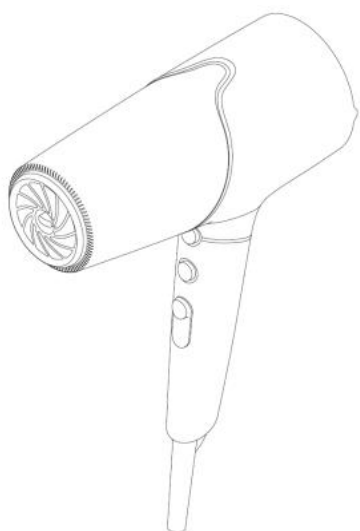

- 
- [11] 2118356.9M003  
[15] 20-07-2021  
[30] 20-01-2021 / EU / 008409361-0005  
[51] Cl. 28-03  
[54] 風筒  
Hairdryer  
[73] Koninklijke Philips N.V.  
High Tech Campus 52,  
5656 AG Eindhoven,  
Netherlands  
[74] Rouse & Co. International (Overseas) Limited  
26/F., Tesbury Centre,  
28 Queen's Road East,  
Hong Kong

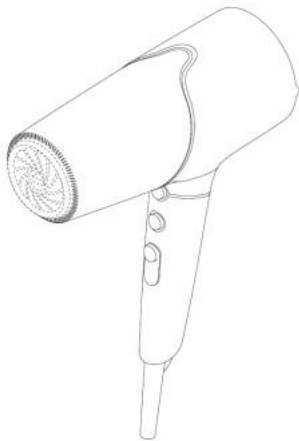

---

[11] 2118356.9M004

[15] 20-07-2021

[30] 20-01-2021 / EU / 008409361-0006

[51] Cl. 28-03

[54] 風筒

Hairdryer

[73] Koninklijke Philips N.V.

High Tech Campus 52,

5656 AG Eindhoven,

Netherlands

[74] Rouse & Co. International (Overseas) Limited

26/F., Tesbury Centre,

28 Queen's Road East,

Hong Kong

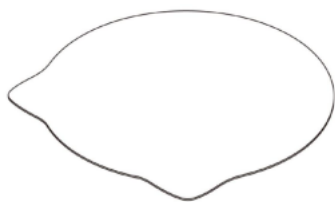

---

[11] 2118356.9M005

[15] 20-07-2021

[30] 20-01-2021 / EU / 008409361-0007

[51] Cl. 28-03

[54] 風筒

Hairdryer

[73] Koninklijke Philips N.V.

High Tech Campus 52,

5656 AG Eindhoven,

Netherlands

[74] Rouse & Co. International (Overseas) Limited

26/F., Tesbury Centre,

28 Queen's Road East,

Hong Kong

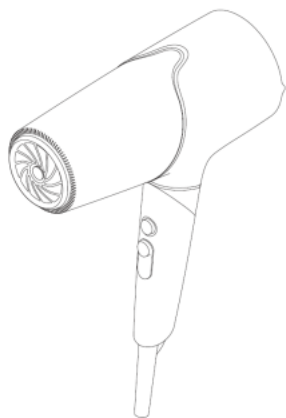

---

[11] 2118356.9M006

[15] 20-07-2021

[30] 20-01-2021 / EU / 008409361-0008

[51] Cl. 28-03

[54] 風筒

Hairdryer

[73] Koninklijke Philips N.V.

High Tech Campus 52,

5656 AG Eindhoven,

Netherlands

[74] Rouse & Co. International (Overseas) Limited

26/F., Tesbury Centre,

28 Queen's Road East,

Hong Kong



---

[11] 2118381.1

[15] 23-07-2021

[30] 25-01-2021 / CN / 202130052685.5

[51] Cl. 13-02

[54] 無線充電器

Wireless charger

[73] 北京小米移動軟件有限公司

BEIJING XIAOMI MOBILE SOFTWARE CO., LTD.

中國內地

北京市海澱區西二旗中路 33 號院

6 號樓 8 層 018 號

[74] 香港派特恩知識產權代理有限公司

香港上環

永樂街 121-125 號

永達商業大廈 10 樓 C 室

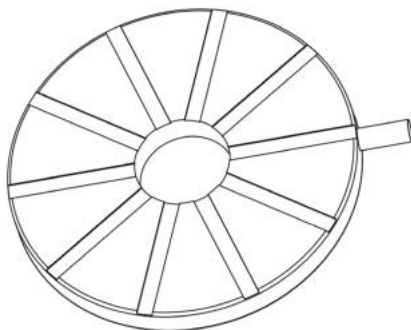

---

[11] 2118382.3



- [15] 23-07-2021
- [30] 12-05-2021 / CN / 202130282838.5
- [51] C1. 15-99
- [54] 倉儲機器人  
Storage robot
- [73] 深圳市海柔創新科技有限公司  
中國內地  
廣東省深圳市寶安區西鄉街道南昌社區航城大道  
華豐國際機器人產業園 G 棟  
G101-G111 號、二層 G201-G211 號 (郵編: 518000)
- [74] 陳鄧郭律師行  
香港灣仔  
軒尼詩道 48-62 號  
上海實業大廈 25 樓 2503-2504 室



- 
- [11] 2118383.5
- [15] 23-07-2021
- [30] 09-02-2021 / CN / 202130095315.X
- [51] C1. 12-05
- [54] 裝卸機組件  
Loader component
- [73] 深圳市海柔創新科技有限公司  
中國內地  
廣東省深圳市寶安區西鄉街道南昌社區航城大道  
華豐國際機器人產業園 G 棟  
G101-G111 號、二層 G201-G211 號 (郵編: 518000)
- [74] 陳鄧郭律師行  
香港灣仔

軒尼詩道 48-62 號

上海實業大廈 25 樓 2503-2504 室

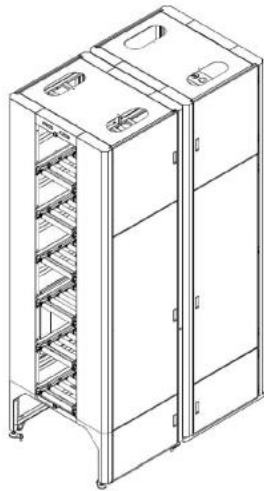

---

[11] 2118384.7

[15] 23-07-2021

[30] 26-01-2021 / CN / 202130057027.5

[51] C1. 14-03

[54] 手機

Mobile phone

[73] 北京小米移動軟件有限公司

BEIJING XIAOMI MOBILE SOFTWARE CO., LTD.

中國內地

北京市海澱區西二旗中路 33 號院

6 號樓 8 層 018 號

[74] 香港派特恩知識產權代理有限公司

香港上環

永樂街 121-125 號

永達商業大廈 10 樓 C 室



---

[11] 2118385.0

[15] 23-07-2021

[30] 25-01-2021 / CN / 202130053329.5

[51] Cl. 14-02

[54] 平板電腦

Tablet computer

[73] 北京小米移動軟件有限公司

BEIJING XIAOMI MOBILE SOFTWARE CO., LTD.

中國內地

北京市海澱區西二旗中路 33 號院

6 號樓 8 層 018 號

[74] 香港派特恩知識產權代理有限公司

香港上環

永樂街 121-125 號

永達商業大廈 10 樓 C 室

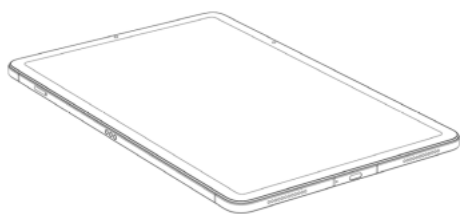

---

[11] 2118394.8

[15] 26-07-2021

[30] 27-01-2021 / CN / 202130060642.1

[51] Cl. 13-02

[54] 無線充電器  
Wireless charger

[73] 北京小米移動軟件有限公司  
BEIJING XIAOMI MOBILE SOFTWARE CO., LTD.  
中國內地  
北京市海澱區西二旗中路 33 號院  
6 號樓 8 層 018 號

[74] 香港派特恩知識產權代理有限公司  
香港上環  
永樂街 121-125 號  
永達商業大廈 10 樓 C 室

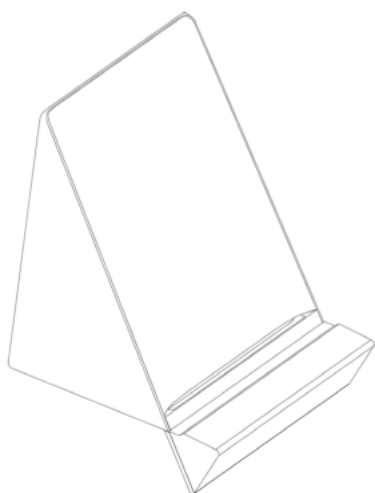

---

[11] 2118449.6

[15] 03-08-2021

[51] Cl. 10-04

[54] 酒精測試器  
Alcohol tester

[73] 冠一產品製造有限公司  
A&A Product Manufacturing Limited  
香港新界  
沙田安平街 6 號  
新貿中心 A 座 18 樓 9 室

PANG SHEK LIU  
香港新界

沙田安平街 6 號  
新貿中心 A 座 18 樓 9 室

- [74] A&A PRODUCT MANUFACTURING LTD (Attn: PANG SHEK LIU)  
香港新界  
沙田安平街 6 號  
新貿中心 A 座 18 樓 9 室

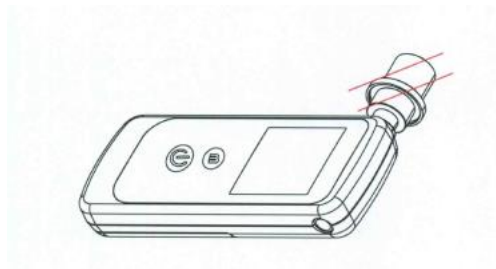

- 
- [11] 2118457.3M001  
[15] 04-08-2021  
[30] 19-02-2021 / EU / 008438428-0001  
[51] Cl. 10-07  
[54] 錶殼  
Watch case  
[73] Daniel Wellington AB  
Vasagatan 12,  
111 20 Stockholm,  
Sweden  
[74] AWA ASIA LIMITED  
Suite 1411, 14/F, Leighton Centre,  
77 Leighton Road,  
Causeway Bay, Hong Kong

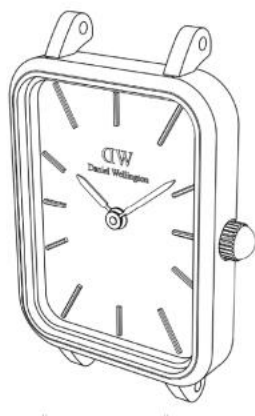

- [11] 2118457.3M002  
[15] 04-08-2021  
[30] 19-02-2021 / EU / 008438428-0002  
[51] Cl. 10-07  
[54] 錶殼  
Watch case  
[73] Daniel Wellington AB  
Vasagatan 12,  
111 20 Stockholm,  
Sweden  
[74] AWA ASIA LIMITED  
Suite 1411, 14/F, Leighton Centre,  
77 Leighton Road,  
Causeway Bay, Hong Kong

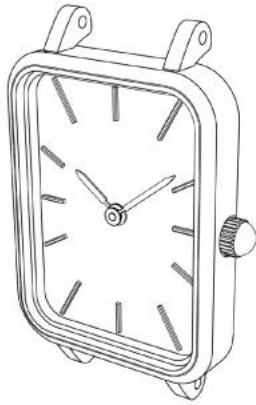

- 
- [11] 2118457.3M003  
[15] 04-08-2021  
[30] 19-02-2021 / EU / 008438428-0011  
[51] Cl. 10-02  
[54] 腕錶  
Wristwatch  
[73] Daniel Wellington AB  
Vasagatan 12,  
111 20 Stockholm,  
Sweden  
[74] AWA ASIA LIMITED  
Suite 1411, 14/F, Leighton Centre,  
77 Leighton Road,  
Causeway Bay, Hong Kong



---

[11] 2118458.5

[15] 04-08-2021

[30] 05-02-2021 / CN / 202130087481.5

[51] Cl. 14-03

[54] 手機

Mobile phone

[73] 北京小米移動軟件有限公司

BEIJING XIAOMI MOBILE SOFTWARE CO., LTD.

中國內地

北京市海澱區西二旗中路 33 號院

6 號樓 8 層 018 號

[74] 香港派特恩知識產權代理有限公司

香港上環

永樂街 121-125 號

永達商業大廈 10 樓 C 室



---

[11] 2118474.8

[15] 06-08-2021

[51] Cl. 8-07

[54] 鎖扣鋼

Interlocking steel

[73] GWP Engineering Limited

703 Hopeful Factory Centre,  
10-16 Wo Shing Street,  
Fo Tan, Shatin, Hong Kong

[74] OLDHAM LI & NIE SOLICITORS

503, St. George's Building,  
2 Ice House Street,  
Central, Hong Kong

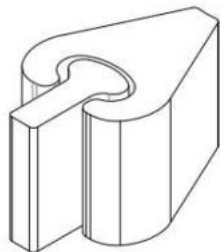

---

[11] 2118480.1

[15] 09-08-2021

[30] 09-02-2021 / CN / 202130094282.7

[51] Cl. 23-01

[54] 淨水器

Water purifier

[73] 北京小米移動軟件有限公司

BEIJING XIAOMI MOBILE SOFTWARE CO., LTD.

中國內地

北京市海澱區西二旗中路 33 號院

6 號樓 8 層 018 號

[74] 香港派特恩知識產權代理有限公司

香港上環

永樂街 121-125 號

永達商業大廈 10 樓 C 室



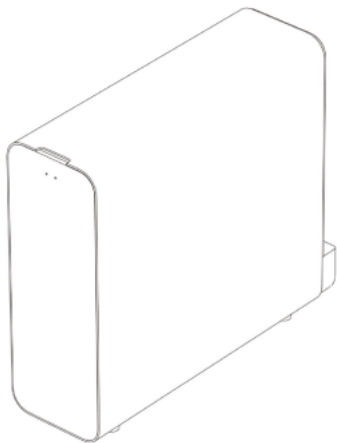

---

[11] 2118481.3

[15] 09-08-2021

[30] 09-02-2021 / CN / 202130093742.4

[51] C1. 23-01

[54] 水龍頭

Tap

[73] 北京小米移動軟件有限公司

BEIJING XIAOMI MOBILE SOFTWARE CO., LTD.

中國內地

北京市海澱區西二旗中路 33 號院

6 號樓 8 層 018 號

[74] 香港派特恩知識產權代理有限公司

香港上環

永樂街 121-125 號

永達商業大廈 10 樓 C 室

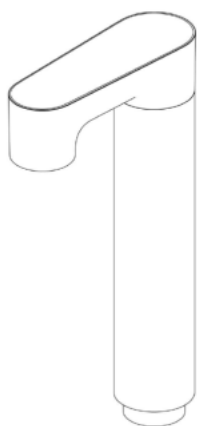

[11] 2118485.2M001

[15] 09-08-2021

[30] 09-02-2021 / CN / 202130095314.5

[51] C1. 12-05

[54] 裝卸機

Loader

[73] 深圳市海柔創新科技有限公司

中國內地

廣東省深圳市寶安區西鄉街道南昌社區航城大道

華豐國際機器人產業園 G 棟

G101-G111 號、二層 G201-G211 號 (郵編: 518000)

[74] 陳鄧郭律師行

香港灣仔

軒尼詩道 48-62 號

上海實業大廈 25 樓 2503-2504 室



[11] 2118485.2M002

[15] 09-08-2021

[30] 09-02-2021 / CN / 202130095314.5

[51] C1. 12-05

[54] 裝卸機

Loader

[73] 深圳市海柔創新科技有限公司

中國內地

廣東省深圳市寶安區西鄉街道南昌社區航城大道

華豐國際機器人產業園 G 棟

G101-G111 號、二層 G201-G211 號 (郵編: 518000)

- [74] 陳鄧郭律師行  
香港灣仔  
軒尼詩道 48-62 號  
上海實業大廈 25 樓 2503-2504 室



- 
- [11] 2118509.5  
[15] 17-08-2021  
[51] Cl. 21-01  
[54] 玩具  
Toy  
[73] The ElvesWand Visual Production Limited  
香港鰂魚涌  
海澤街 28 號  
東港中心 10 樓 1008 室  
[74] 李嘉榮  
香港鰂魚涌  
海澤街 28 號  
東港中心 10 樓 1008 室

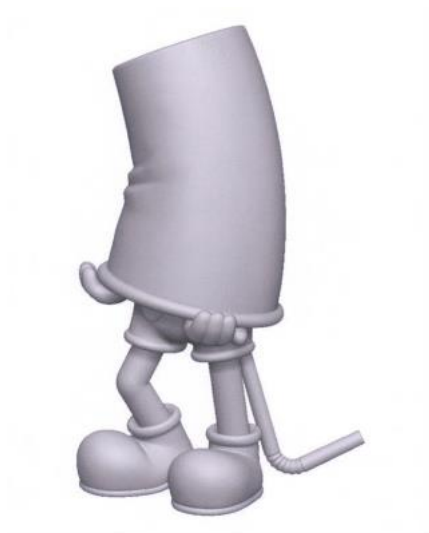

---

[11] 2118511.9

[15] 17-08-2021

[51] Cl. 11-02

[54] 小擺設  
Trinket

[73] 蔡快常

Choy Fai Sheung

香港新界荃灣

深井青山公路深井段 41-63 號

麗都花園 2 座 8 樓 G 室

[74] Choy Fai Sheung

香港新界荃灣

深井青山公路深井段 41-63 號

麗都花園 2 座 8 樓 G 室



[11] 2118513.3

[15] 17-08-2021

[51] Cl. 7-02

[54] 容器

Container

[73] 瀛海國際有限公司

Oceana International Co Limited

Flat/Room 18-19, Block A, 21/F, Regent Centre,

No. 63 Wo Yi Hop Road,

Kwai Chung, New Territories, Hong Kong

[74] GLOBAL INTELLECTUAL PROPERTY COMPANY LIMITED

Unit 602-3 & 5, 6/F, Exchange Tower,

33 Wang Chiu Road,

Kowloon Bay, Kowloon, Hong Kong



---

[11] 2118514.5

[15] 17-08-2021

[51] Cl. 1-01

[54] 朱古力

Chocolate

[73] 瀛海國際有限公司

Oceana International Co Limited

Flat/Room 18-19, Block A, 21/F, Regent Centre,

No. 63 Wo Yi Hop Road,

Kwai Chung, New Territories, Hong Kong

[74] GLOBAL INTELLECTUAL PROPERTY COMPANY LIMITED

Unit 602-3 & 5, 6/F, Exchange Tower,

33 Wang Chiu Road,

Kowloon Bay, Kowloon, Hong Kong



---

[11] 2118515.8

[15] 17-08-2021

[51] Cl. 1-01

[54] 朱古力

Chocolate

[73] 瀛海國際有限公司

Oceana International Co Limited

Flat/Room 18-19, Block A, 21/F, Regent Centre,

No. 63 Wo Yi Hop Road,

Kwai Chung, New Territories, Hong Kong

[74] GLOBAL INTELLECTUAL PROPERTY COMPANY LIMITED

Unit 602-3 & 5, 6/F, Exchange Tower,

33 Wang Chiu Road,

Kowloon Bay, Kowloon, Hong Kong



---

[11] 2118521.0

[15] 18-08-2021

[30] 19-02-2021 / US / 29/771,082

[51] Cl. 7-01

[54] 容器

Container

[73] Merrilee Kick

2114 McDaniel Drive,  
Carrollton, Texas 75006,  
United States of America

[74] LIU, SHEN & ASSOCIATES

Room 3716, 37/F, Sun Hung Kai Centre,  
30 Harbour Road,  
Wanchai, Hong Kong

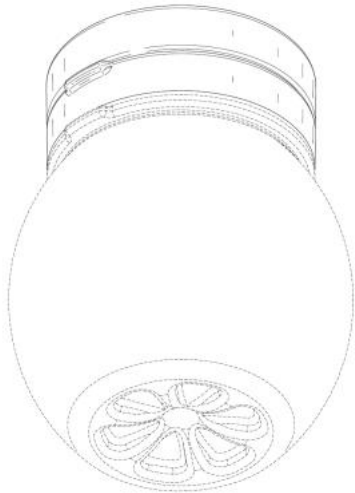

---

[11] 2118524.6

[15] 24-08-2021

[51] Cl. 17-99

[54] 結他效果器

Guitar effect pedal

[73] 徐揚宙

Tsui Yeung Chau

香港新界

葵涌石蔭街 101 號

國寶樓 6A 室

[74] 徐揚宙

香港新界

葵涌石蔭路 101 號

國寶樓 6A 室

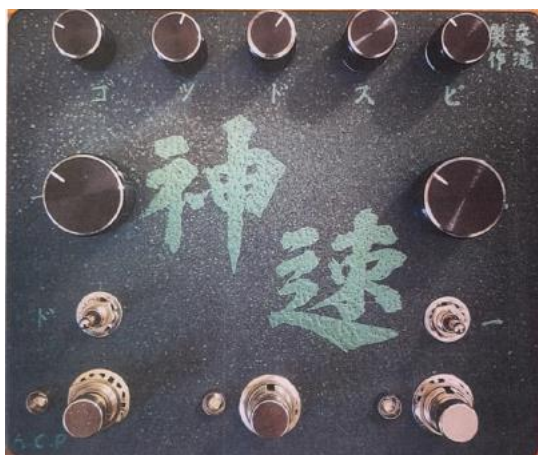

---

[11] 2118559.0

[15] 25-08-2021

[30] 30-06-2021 / US / 29/797,424

[51] Cl. 23-04

[54] 植物生長架的送風裝置

Air delivery apparatus for plant grow rack

[73] HGCI, Inc.

3993 Howard Hughes Parkway,  
Suite 250, Las Vegas, NV 89169,  
United States of America

[74] LIU, SHEN & ASSOCIATES

Room 3716, 37/F, Sun Hung Kai Centre,  
30 Harbour Road,  
Wanchai, Hong Kong

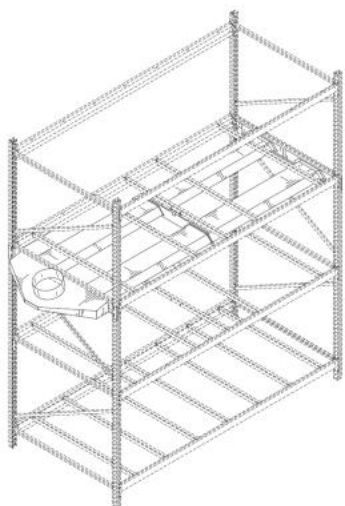

---

[11] 2118567.7



[15] 25-08-2021

[51] Cl. 26-02

[54] 燈籠  
Lantern

[73] 黃宏宇  
HUANG, Hongyu  
中國內地  
廣東省廣州市荔灣區錦佳四街  
2 號 C8 棟 5201

[74] 普衡知識產權代理有限公司  
香港上環  
永樂街 72-74 號  
永利大廈 9 字樓 C 室

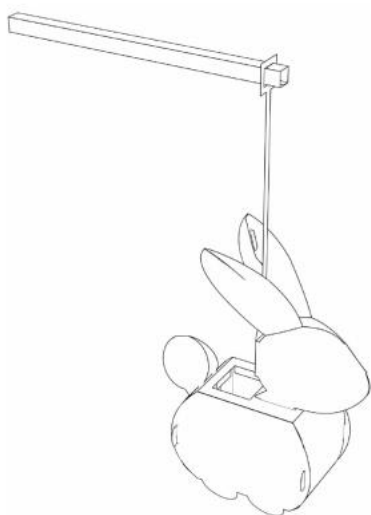

---

[11] 2118597.0M001

[15] 01-09-2021

[30] 01-03-2021 / CN / 202130111758.3

[51] Cl. 23-04

[54] 空調  
Air conditioner

[73] 北京小米移動軟件有限公司  
Beijing Xiaomi Mobile Software Co., Ltd.  
中國內地  
北京市海澱區西二旗中路 33 號院  
6 號樓 8 層 018 號

[74] 隆天專利商標代理有限公司  
香港長沙灣  
青山道 485 號  
九龍廣場 10 樓 11 室



---

[11] 2118597.0M002

[15] 01-09-2021

[30] 01-03-2021 / CN / 202130111758.3

[51] Cl. 23-04

[54] 空調

Air conditioner

[73] 北京小米移動軟件有限公司

Beijing Xiaomi Mobile Software Co., Ltd.

中國內地

北京市海澱區西二旗中路 33 號院

6 號樓 8 層 018 號

[74] 隆天專利商標代理有限公司

香港長沙灣

青山道 485 號

九龍廣場 10 樓 11 室

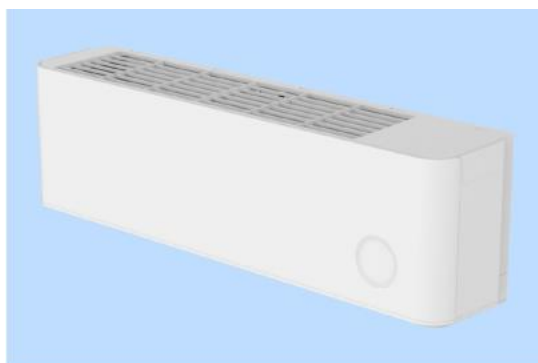

---

[11] 2118598.2

[15] 01-09-2021

[30] 01-03-2021 / CN / 202130112091.9

[51] Cl. 23-04

[54] 空調

Air conditioner

[73] 北京小米移動軟件有限公司  
Beijing Xiaomi Mobile Software Co., Ltd.  
中國內地  
北京市海澱區西二旗中路 33 號院  
6 號樓 8 層 018 號

[74] 隆天專利商標代理有限公司  
香港長沙灣  
青山道 485 號  
九龍廣場 10 樓 11 室

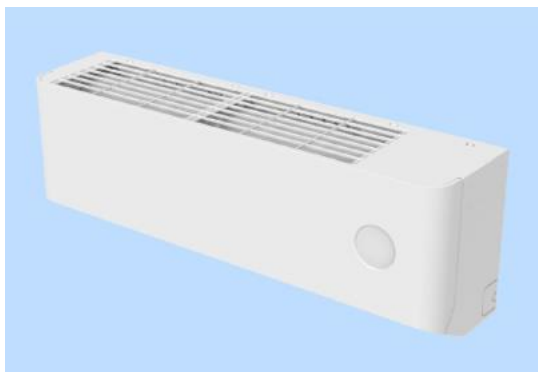

---

[11] 2118602.2

[15] 02-09-2021

[51] C1. 19-08

[54] 包裝標籤  
Packaging label

[73] 努恩安卡拉意面工貿股份公司  
NUH'UN ANKARA MAKARNASI SANAYI VE TICARET ANONIM SIRKETI  
土耳其  
安卡拉市辛坎區阿特諾度街 1 號  
集體工業園

[74] 旻貝國際知識產權代理有限公司  
香港新界  
白石角香港科學園  
第三期科技大道西 12 號 2 樓 230 室

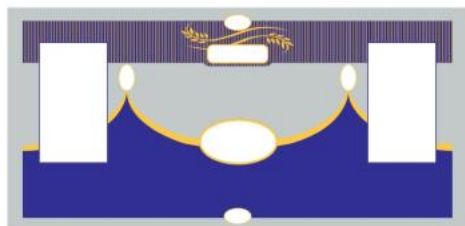

[11] 2118603.4

[15] 02-09-2021

[51] Cl. 19-08

[54] 包裝標籤

Packaging label

[73] 努恩安卡拉意面工貿股份公司

NUH'UN ANKARA MAKARNASI SANAYI VE TICARET ANONIM SIRKETI

土耳其

安卡拉市辛坎區阿特諾度街 1 號

集體工業園

[74] 旻貝國際知識產權代理有限公司

香港新界

白石角香港科學園

第三期科技大道西 12 號 2 樓 230 室



[11] 2118604.6

[15] 02-09-2021

[51] Cl. 19-08

[54] 包裝標籤

Packaging label

[73] 努恩安卡拉意面工貿股份公司

NUH'UN ANKARA MAKARNASI SANAYI VE TICARET ANONIM SIRKETI

土耳其

安卡拉市辛坎區阿特諾度街 1 號

集體工業園

[74] 旻貝國際知識產權代理有限公司

香港新界

白石角香港科學園

第三期科技大道西 12 號 2 樓 230 室

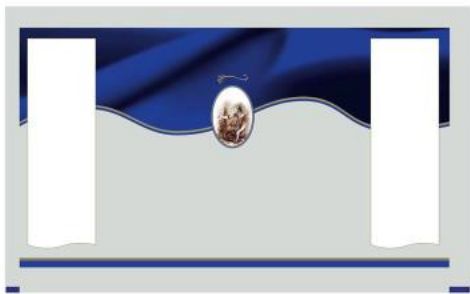

---

[11] 2118606.1M001

[15] 03-09-2021

[30] 07-06-2021 / US / 29/787,486

[51] Cl. 7-02

[54] 熱飲製造機

Hot beverage maker

[73] Starbucks Corporation

2401 Utah Avenue South,

Seattle, WA 98134,

United States of America

[74] CHINA PATENT AGENT (HONG KONG) LIMITED

22/F, Great Eagle Centre,

23 Harbour Road,

Wanchai, Hong Kong

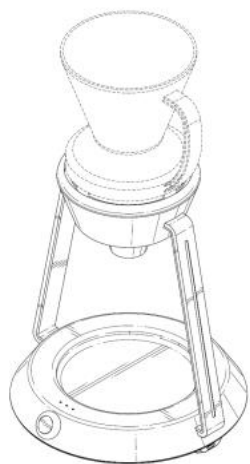

---

[11] 2118606.1M002

[15] 03-09-2021

[30] 07-06-2021 / US / 29/787,486

[51] Cl. 7-02

[54] 熱飲制造機

Hot beverage maker

[73] Starbucks Corporation

2401 Utah Avenue South,

Seattle, WA 98134,

United States of America

[74] CHINA PATENT AGENT (HONG KONG) LIMITED

22/F, Great Eagle Centre,

23 Harbour Road,

Wanchai, Hong Kong

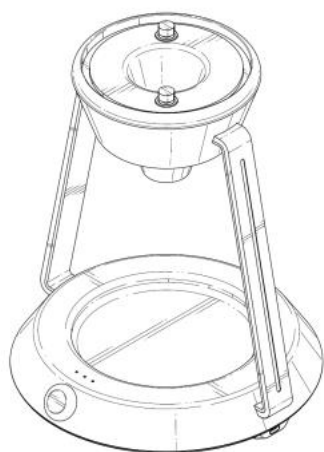

---

[11] 2118615.0M001

[15] 03-09-2021

[30] 05-03-2021 / CN / 202130122075.8

[51] C1. 15-05

[54] 洗衣機

Washing machine

[73] 北京小米移動軟件有限公司

BEIJING XIAOMI MOBILE SOFTWARE CO., LTD.

中國內地

北京市海澱區西二旗中路

33 號院 6 號樓 8 層 018 號

[74] 高保知識產權代理有限公司

香港荃灣

白田壩街 36-44 號

信義工業大廈 9 樓



---

[11] 2118615.0M002

[15] 03-09-2021

[30] 05-03-2021 / CN / 202130122075.8

[51] Cl. 15-05

[54] 洗衣機

Washing machine

[73] 北京小米移動軟件有限公司

BEIJING XIAOMI MOBILE SOFTWARE CO., LTD.

中國內地

北京市海澱區西二旗中路

33 號院 6 號樓 8 層 018 號

[74] 高保知識產權代理有限公司

香港荃灣

白田壩街 36-44 號

信義工業大廈 9 樓



[11] 2118615.0M003

[15] 03-09-2021

[30] 05-03-2021 / CN / 202130122075.8

[51] C1. 15-05

[54] 洗衣機

Washing machine

[73] 北京小米移動軟件有限公司

BEIJING XIAOMI MOBILE SOFTWARE CO., LTD.

中國內地

北京市海澱區西二旗中路

33 號院 6 號樓 8 層 018 號

[74] 高保知識產權代理有限公司

香港荃灣

白田壩街 36-44 號

信義工業大廈 9 樓



---

[11] 2118615.0M004

[15] 03-09-2021

[30] 05-03-2021 / CN / 202130122075.8

[51] C1. 15-05

[54] 洗衣機

Washing machine

[73] 北京小米移動軟件有限公司

BEIJING XIAOMI MOBILE SOFTWARE CO., LTD.

中國內地

北京市海澱區西二旗中路

33 號院 6 號樓 8 層 018 號



- [74] 高保知識產權代理有限公司  
香港荃灣  
白田壩街 36-44 號  
信義工業大廈 9 樓



- 
- [11] 2118616.2  
[15] 03-09-2021  
[30] 04-03-2021 / CN / 202130119274.3  
[51] Cl. 15-07  
[54] 冰箱  
Refrigerator  
[73] 北京小米移動軟件有限公司  
BEIJING XIAOMI MOBILE SOFTWARE CO., LTD.  
中國內地  
北京市海澱區西二旗中路  
33 號院 6 號樓 8 層 018 號  
[74] 高保知識產權代理有限公司  
香港荃灣  
白田壩街 36-44 號  
信義工業大廈 9 樓

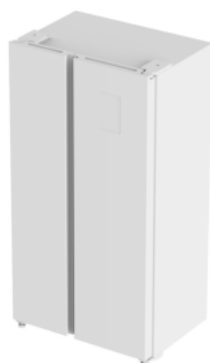

- 
- [11] 2118617.4  
[15] 03-09-2021  
[30] 04-03-2021 / CN / 202130119258.4  
[51] Cl. 15-07  
[54] 冰箱  
Refrigerator  
[73] 北京小米移動軟件有限公司  
BEIJING XIAOMI MOBILE SOFTWARE CO., LTD.  
中國內地  
北京市海澱區西二旗中路  
33 號院 6 號樓 8 層 018 號  
[74] 高保知識產權代理有限公司  
香港荃灣  
白田壩街 36-44 號  
信義工業大廈 9 樓



- 
- [11] 2118618.6M001  
[15] 03-09-2021  
[30] 31-03-2021 / CA, AM, AZ, BZ, BA, GE, LI, MK, MD, MC, MN, ME,  
MA, NO, OM, SG, CH, TN, TR, UA, GB, EU, AL, KG / DM/213 583

[51] Cl. 11-01

[54] 指環  
Ring

[73] Harry Winston SA  
Chemin du Tourbillon 8,  
CH-1228 Plan-les-Ouates,  
Switzerland

[74] SPRUSON & FERGUSON (HONG KONG) LIMITED  
5001 Hopewell Centre,  
183 Queen's Road East,  
Wan Chai, Hong Kong



---

[11] 2118618.6M002

[15] 03-09-2021

[30] 31-03-2021 / CA, AM, AZ, BZ, BA, GE, LI, MK, MD, MC, MN, ME,  
MA, NO, OM, SG, CH, TN, TR, UA, GB, EU, AL, KG / DM/213 583

[51] Cl. 11-01

[54] 耳環  
Earrings

[73] Harry Winston SA  
Chemin du Tourbillon 8,  
CH-1228 Plan-les-Ouates,  
Switzerland

[74] SPRUSON & FERGUSON (HONG KONG) LIMITED  
5001 Hopewell Centre,  
183 Queen's Road East,  
Wan Chai, Hong Kong



---

[11] 2118618.6M003

[15] 03-09-2021

[30] 31-03-2021 / CA, AM, AZ, BZ, BA, GE, LI, MK, MD, MC, MN, ME, MA, NO, OM, SG, CH, TN, TR, UA, GB, EU, AL, KG / DM/213 583

[51] Cl. 11-01

[54] 項鍊

Necklace

[73] Harry Winston SA

Chemin du Tourbillon 8,  
CH-1228 Plan-les-Ouates,  
Switzerland

[74] SPRUSON & FERGUSON (HONG KONG) LIMITED

5001 Hopewell Centre,  
183 Queen's Road East,  
Wan Chai, Hong Kong



---

[11] 2118618.6M004

[15] 03-09-2021

[30] 31-03-2021 / CA, AM, AZ, BZ, BA, GE, LI, MK, MD, MC, MN, ME, MA, NO, OM, SG, CH, TN, TR, UA, GB, EU, AL, KG / DM/213 583

[51] Cl. 11-01

[54] 手鏈

Bracelet

[73] Harry Winston SA

Chemin du Tourbillon 8,  
CH-1228 Plan-les-Ouates,  
Switzerland

[74] SPRUSON & FERGUSON (HONG KONG) LIMITED

5001 Hopewell Centre,  
183 Queen's Road East,  
Wan Chai, Hong Kong



---

[11] 2118618.6M005

[15] 03-09-2021

[30] 31-03-2021 / CA, AM, AZ, BZ, BA, GE, LI, MK, MD, MC, MN, ME,  
MA, NO, OM, SG, CH, TN, TR, UA, GB, EU, AL, KG / DM/213 583

[51] Cl. 11-01

[54] 指環

Ring

[73] Harry Winston SA

Chemin du Tourbillon 8,  
CH-1228 Plan-les-Ouates,  
Switzerland

[74] SPRUSON & FERGUSON (HONG KONG) LIMITED

5001 Hopewell Centre,  
183 Queen's Road East,  
Wan Chai, Hong Kong



---

[11] 2118626.3

[15] 06-09-2021

[30] 20-07-2021 / CN / 202130461770.7

[51] Cl. 28-99

[54] 洗衣凝珠

Laundry capsules

[73] 威萊亞太私人有限公司

WHEALTH LOHMANN CENTRALIN (ASIA PACIFIC) PTE. LTD.

新加坡

哈珀路 6 號#01-09

梁華大廈

[74] 精英知識產權服務有限公司

香港九龍

彌敦道 695 號

永如大廈 12 字樓

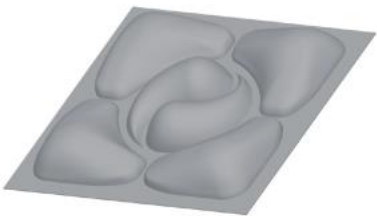

---

[11] 2118627.5

[15] 06-09-2021

[30] 20-07-2021 / CN / 202130461770.7

[51] Cl. 28-99

[54] 洗衣凝珠

Laundry capsules

[73] 威萊亞太私人有限公司

WHEALTH LOHMANN CENTRALIN (ASIA PACIFIC) PTE. LTD.

新加坡

哈珀路 6 號#01-09

梁華大廈

[74] 精英知識產權服務有限公司

香港九龍

彌敦道 695 號

永如大廈 12 字樓

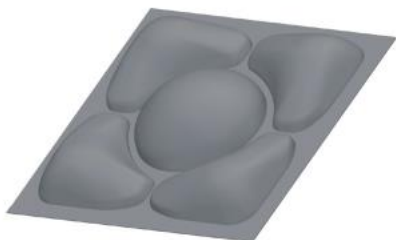

---

[11] 2118628.7

[15] 06-09-2021

[51] Cl. 16-06

[54] 眼鏡臂

Spectacle arm

[73] SUN HING OPTICAL MANUFACTORY LIMITED

1001C, 10th Floor, Sunbeam Centre,

27 Shing Yip Street,

Kwun Tong, Kowloon, Hong Kong

[74] IVAN WONG IP LIMITED

Unit 1102, 11/F.,

88 Gloucester Road,

Wanchai, Hong Kong



- [11] 2118631.3  
[15] 08-09-2021  
[30] 08-03-2021 / CN / 202130124696.X  
[51] Cl. 23-04  
[54] 新風空調  
Fresh air conditioner  
[73] 北京小米移動軟件有限公司  
Beijing Xiaomi Mobile Software Co., Ltd.  
中國內地  
北京市海澱區西二旗中路 33 號院  
6 號樓 8 層 018 號  
[74] 隆天專利商標代理有限公司  
香港  
長沙灣青山道 485 號  
九龍廣場 10 樓 11 室



- 
- [11] 2118632.5  
[15] 08-09-2021  
[30] 08-03-2021 / CN / 202130124452.1  
[51] Cl. 23-04  
[54] 空調  
Air conditioner  
[73] 北京小米移動軟件有限公司  
Beijing Xiaomi Mobile Software Co., Ltd.  
中國內地  
北京市海澱區西二旗中路 33 號院  
6 號樓 8 層 018 號  
[74] 隆天專利商標代理有限公司  
香港  
長沙灣青山道 485 號  
九龍廣場 10 樓 11 室





---

[11] 2118633.7

[15] 08-09-2021

[30] 08-03-2021 / CN / 202130124574.0

[51] Cl. 23-04

[54] 空調室外機

Air conditioner outdoor unit

[73] 北京小米移動軟件有限公司

Beijing Xiaomi Mobile Software Co., Ltd.

中國內地

北京市海澱區西二旗中路 33 號院

6 號樓 8 層 018 號

[74] 隆天專利商標代理有限公司

香港

長沙灣青山道 485 號

九龍廣場 10 樓 11 室



- [11] 2118634.9  
[15] 08-09-2021  
[51] Cl. 12-08  
[54] 客車  
Bus  
[73] 珠海廣通車輛製造有限公司  
中國內地  
廣東省珠海市金灣區三灶鎮機場北路 957 號  
廠房 2#廠房  
[74] 香港工業總會  
香港九龍  
長沙灣長裕街八號  
億京廣場三十一樓



- 
- [11] 2118641.4M001  
[15] 09-09-2021  
[30] 30-03-2021 / US / 29/776,495  
[51] Cl. 24-02  
[54] 手持式藥物遞送裝置  
Handheld drug delivery device  
[73] AMGEN INC.  
One Amgen Center Drive,  
Thousand Oaks, CA 91320-1799,  
United States of America  
[74] CHINA PATENT AGENT (HONG KONG) LIMITED  
22/F, Great Eagle Centre,  
23 Harbour Road,  
Wanchai, Hong Kong

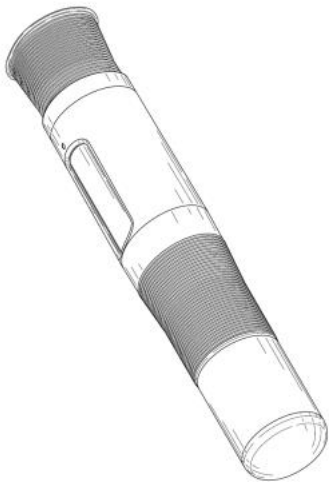

---

[11] 2118641.4M002

[15] 09-09-2021

[30] 30-03-2021 / US / 29/776,495

[51] Cl. 24-02

[54] 手持式藥物遞送裝置

Handheld drug delivery device

[73] AMGEN INC.

One Amgen Center Drive,  
Thousand Oaks, CA 91320-1799,  
United States of America

[74] CHINA PATENT AGENT (HONG KONG) LIMITED

22/F, Great Eagle Centre,  
23 Harbour Road,  
Wanchai, Hong Kong



[11] 2118641.4M003

[15] 09-09-2021

[30] 30-03-2021 / US / 29/776,495

[51] Cl. 24-02

[54] 手持式藥物遞送裝置

Handheld drug delivery device

[73] AMGEN INC.

One Amgen Center Drive,  
Thousand Oaks, CA 91320-1799,  
United States of America

[74] CHINA PATENT AGENT (HONG KONG) LIMITED

22/F, Great Eagle Centre,  
23 Harbour Road,  
Wanchai, Hong Kong

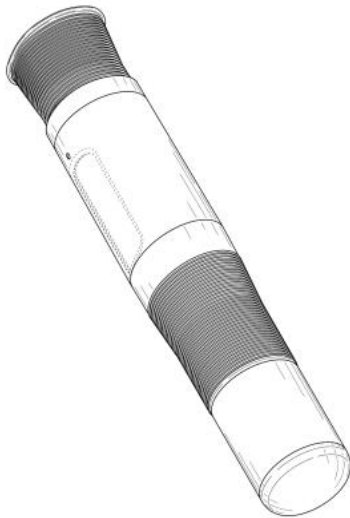

---

[11] 2118641.4M004

[15] 09-09-2021

[30] 30-03-2021 / US / 29/776,495

[51] Cl. 24-02

[54] 手持式藥物遞送裝置

Handheld drug delivery device

[73] AMGEN INC.

One Amgen Center Drive,  
Thousand Oaks, CA 91320-1799,  
United States of America

[74] CHINA PATENT AGENT (HONG KONG) LIMITED

22/F, Great Eagle Centre,  
23 Harbour Road,  
Wanchai, Hong Kong

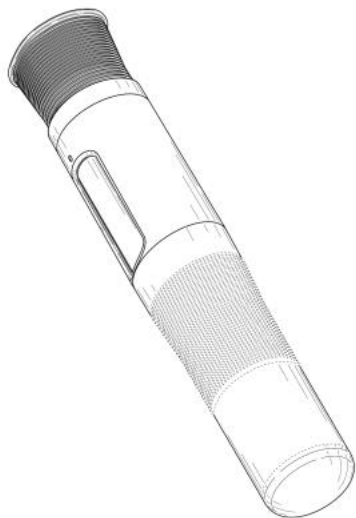

---

[11] 2118641.4M005

[15] 09-09-2021

[30] 30-03-2021 / US / 29/776,495

[51] Cl. 24-02

[54] 手持式藥物遞送裝置

Handheld drug delivery device

[73] AMGEN INC.

One Amgen Center Drive,  
Thousand Oaks, CA 91320-1799,  
United States of America

[74] CHINA PATENT AGENT (HONG KONG) LIMITED

22/F, Great Eagle Centre,  
23 Harbour Road,  
Wanchai, Hong Kong

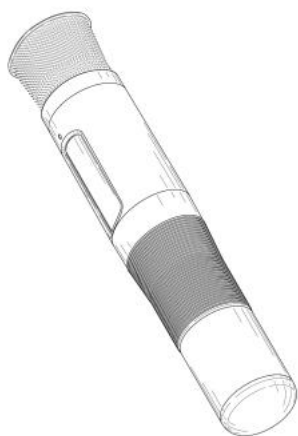

- [11] 2118641.4M006  
[15] 09-09-2021  
[30] 30-03-2021 / US / 29/776,495  
[51] Cl. 24-02  
[54] 手持式藥物遞送裝置  
Handheld drug delivery device  
[73] AMGEN INC.  
One Amgen Center Drive,  
Thousand Oaks, CA 91320-1799,  
United States of America  
[74] CHINA PATENT AGENT (HONG KONG) LIMITED  
22/F, Great Eagle Centre,  
23 Harbour Road,  
Wanchai, Hong Kong

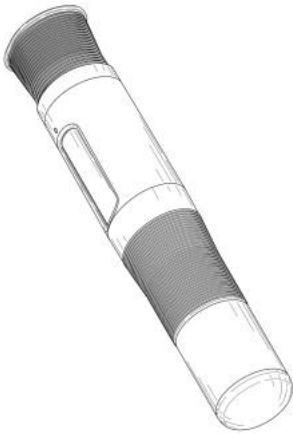

- 
- [11] 2118641.4M007  
[15] 09-09-2021  
[30] 30-03-2021 / US / 29/776,495  
[51] Cl. 24-02  
[54] 手持式藥物遞送裝置  
Handheld drug delivery device  
[73] AMGEN INC.  
One Amgen Center Drive,  
Thousand Oaks, CA 91320-1799,  
United States of America  
[74] CHINA PATENT AGENT (HONG KONG) LIMITED  
22/F, Great Eagle Centre,  
23 Harbour Road,  
Wanchai, Hong Kong

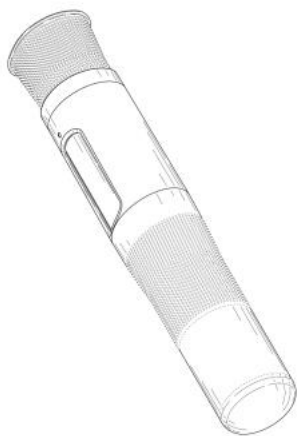

---

[11] 2118642.6M001

[15] 09-09-2021

[30] 10-03-2021 / US / 29/773,601

[51] Cl. 24-02

[54] 手持式藥物遞送裝置

Handheld drug delivery device

[73] AMGEN INC.

One Amgen Center Drive,  
Thousand Oaks, CA 91320-1799,  
United States of America

[74] CHINA PATENT AGENT (HONG KONG) LIMITED

22/F, Great Eagle Centre,  
23 Harbour Road,  
Wanchai, Hong Kong

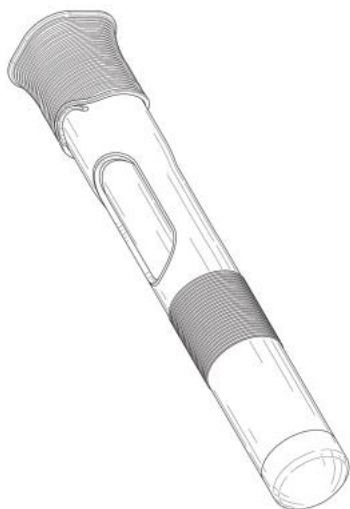

[11] 2118642.6M002

[15] 09-09-2021

[30] 10-03-2021 / US / 29/773,601

[51] Cl. 24-02

[54] 手持式藥物遞送裝置

Handheld drug delivery device

[73] AMGEN INC.

One Amgen Center Drive,  
Thousand Oaks, CA 91320-1799,  
United States of America

[74] CHINA PATENT AGENT (HONG KONG) LIMITED

22/F, Great Eagle Centre,  
23 Harbour Road,  
Wanchai, Hong Kong



---

[11] 2118642.6M003

[15] 09-09-2021

[30] 10-03-2021 / US / 29/773,601

[51] Cl. 24-02

[54] 手持式藥物遞送裝置

Handheld drug delivery device

[73] AMGEN INC.

One Amgen Center Drive,  
Thousand Oaks, CA 91320-1799,  
United States of America

[74] CHINA PATENT AGENT (HONG KONG) LIMITED

22/F, Great Eagle Centre,  
23 Harbour Road,  
Wanchai, Hong Kong



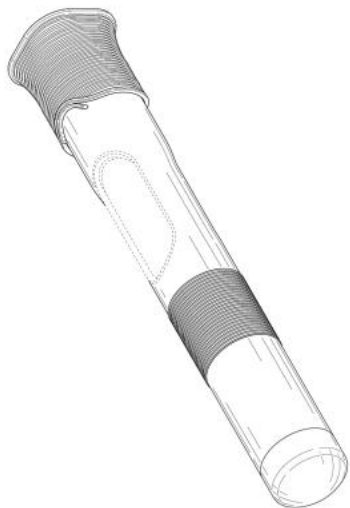

---

[11] 2118642.6M004

[15] 09-09-2021

[30] 10-03-2021 / US / 29/773,601

[51] Cl. 24-02

[54] 手持式藥物遞送裝置

Handheld drug delivery device

[73] AMGEN INC.

One Amgen Center Drive,  
Thousand Oaks, CA 91320-1799,  
United States of America

[74] CHINA PATENT AGENT (HONG KONG) LIMITED

22/F, Great Eagle Centre,  
23 Harbour Road,  
Wanchai, Hong Kong

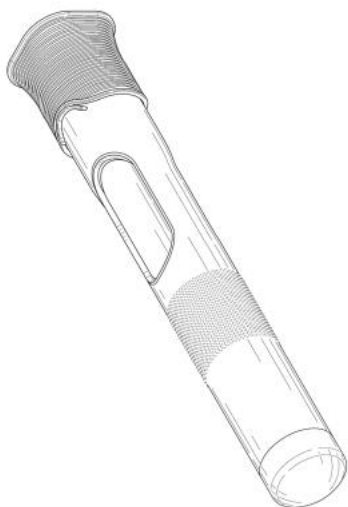

- [11] 2118642.6M005  
[15] 09-09-2021  
[30] 10-03-2021 / US / 29/773,601  
[51] C1. 24-02  
[54] 手持式藥物遞送裝置  
Handheld drug delivery device  
[73] AMGEN INC.  
One Amgen Center Drive,  
Thousand Oaks, CA 91320-1799,  
United States of America  
[74] CHINA PATENT AGENT (HONG KONG) LIMITED  
22/F, Great Eagle Centre,  
23 Harbour Road,  
Wanchai, Hong Kong

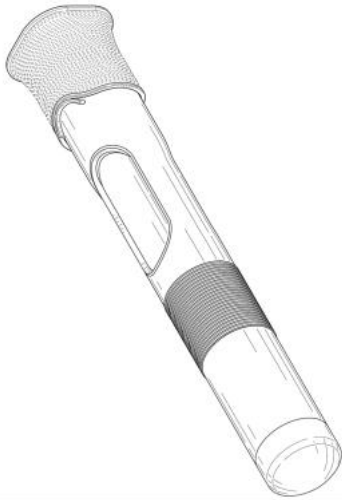

- 
- [11] 2118642.6M006  
[15] 09-09-2021  
[30] 10-03-2021 / US / 29/773,601  
[51] C1. 24-02  
[54] 手持式藥物遞送裝置  
Handheld drug delivery device  
[73] AMGEN INC.  
One Amgen Center Drive,  
Thousand Oaks, CA 91320-1799,  
United States of America  
[74] CHINA PATENT AGENT (HONG KONG) LIMITED  
22/F, Great Eagle Centre,  
23 Harbour Road,  
Wanchai, Hong Kong

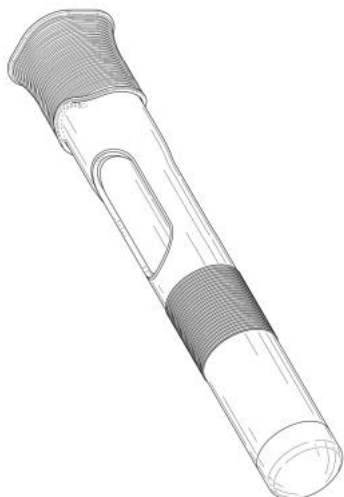

---

[11] 2118642.6M007

[15] 09-09-2021

[30] 10-03-2021 / US / 29/773,601

[51] Cl. 24-02

[54] 手持式藥物遞送裝置

Handheld drug delivery device

[73] AMGEN INC.

One Amgen Center Drive,  
Thousand Oaks, CA 91320-1799,  
United States of America

[74] CHINA PATENT AGENT (HONG KONG) LIMITED

22/F, Great Eagle Centre,  
23 Harbour Road,  
Wanchai, Hong Kong

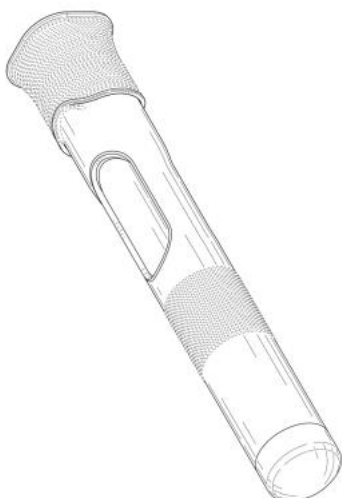

[11] 2118643.8M001

[15] 09-09-2021

[30] 10-03-2021 / US / 29/773,607

[51] C1. 24-02

[54] 手持式藥物遞送裝置

Handheld drug delivery device

[73] AMGEN INC.

One Amgen Center Drive,  
Thousand Oaks, CA 91320-1799,  
United States of America

[74] CHINA PATENT AGENT (HONG KONG) LIMITED

22/F, Great Eagle Centre,  
23 Harbour Road,  
Wanchai, Hong Kong

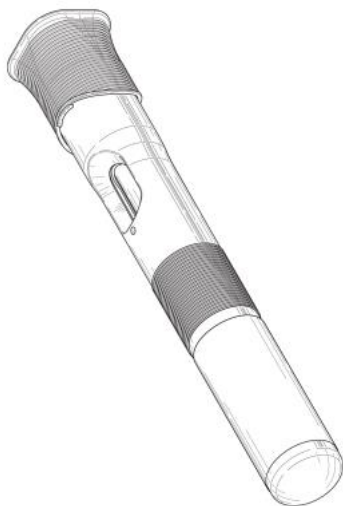

---

[11] 2118643.8M002

[15] 09-09-2021

[30] 10-03-2021 / US / 29/773,607

[51] C1. 24-02

[54] 手持式藥物遞送裝置

Handheld drug delivery device

[73] AMGEN INC.

One Amgen Center Drive,  
Thousand Oaks, CA 91320-1799,  
United States of America

[74] CHINA PATENT AGENT (HONG KONG) LIMITED

22/F, Great Eagle Centre,  
23 Harbour Road,  
Wanchai, Hong Kong



---

[11] 2118643.8M003

[15] 09-09-2021

[30] 10-03-2021 / US / 29/773,607

[51] Cl. 24-02

[54] 手持式藥物遞送裝置

Handheld drug delivery device

[73] AMGEN INC.

One Amgen Center Drive,  
Thousand Oaks, CA 91320-1799,  
United States of America

[74] CHINA PATENT AGENT (HONG KONG) LIMITED

22/F, Great Eagle Centre,  
23 Harbour Road,  
Wanchai, Hong Kong

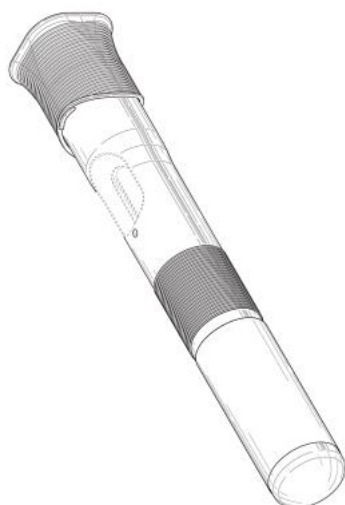

[11] 2118643.8M004

[15] 09-09-2021

[30] 10-03-2021 / US / 29/773,607

[51] C1. 24-02

[54] 手持式藥物遞送裝置

Handheld drug delivery device

[73] AMGEN INC.

One Amgen Center Drive,  
Thousand Oaks, CA 91320-1799,  
United States of America

[74] CHINA PATENT AGENT (HONG KONG) LIMITED

22/F, Great Eagle Centre,  
23 Harbour Road,  
Wanchai, Hong Kong

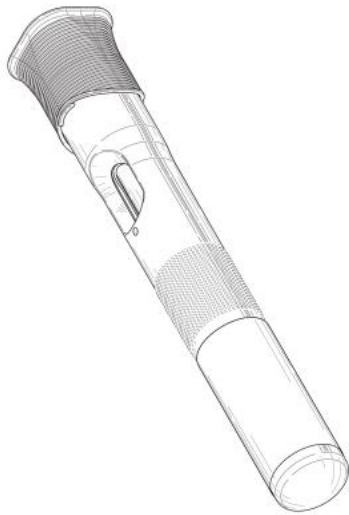

[11] 2118643.8M005

[15] 09-09-2021

[30] 10-03-2021 / US / 29/773,607

[51] C1. 24-02

[54] 手持式藥物遞送裝置

Handheld drug delivery device

[73] AMGEN INC.

One Amgen Center Drive,  
Thousand Oaks, CA 91320-1799,  
United States of America

[74] CHINA PATENT AGENT (HONG KONG) LIMITED

22/F, Great Eagle Centre,  
23 Harbour Road,  
Wanchai, Hong Kong

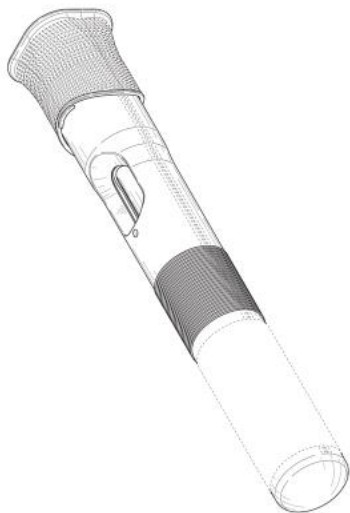

---

[11] 2118643.8M006

[15] 09-09-2021

[30] 10-03-2021 / US / 29/773,607

[51] Cl. 24-02

[54] 手持式藥物遞送裝置

Handheld drug delivery device

[73] AMGEN INC.

One Amgen Center Drive,  
Thousand Oaks, CA 91320-1799,  
United States of America

[74] CHINA PATENT AGENT (HONG KONG) LIMITED

22/F, Great Eagle Centre,  
23 Harbour Road,  
Wanchai, Hong Kong



- [11] 2118643.8M007  
[15] 09-09-2021  
[30] 10-03-2021 / US / 29/773,607  
[51] C1. 24-02  
[54] 手持式藥物遞送裝置  
Handheld drug delivery device  
[73] AMGEN INC.  
One Amgen Center Drive,  
Thousand Oaks, CA 91320-1799,  
United States of America  
[74] CHINA PATENT AGENT (HONG KONG) LIMITED  
22/F, Great Eagle Centre,  
23 Harbour Road,  
Wanchai, Hong Kong

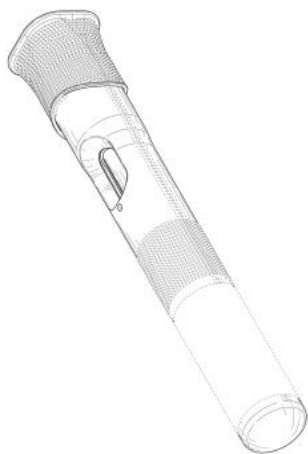

- 
- [11] 2118644.0M001  
[15] 09-09-2021  
[30] 10-03-2021 / US / 29/773,604  
[51] C1. 24-02  
[54] 手持式藥物遞送裝置  
Handheld drug delivery device  
[73] AMGEN INC.  
One Amgen Center Drive,  
Thousand Oaks, CA 91320-1799,  
United States of America  
[74] CHINA PATENT AGENT (HONG KONG) LIMITED  
22/F, Great Eagle Centre,  
23 Harbour Road,  
Wanchai, Hong Kong



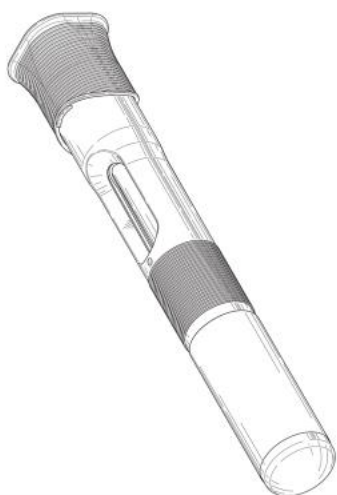

---

[11] 2118644.0M002

[15] 09-09-2021

[30] 10-03-2021 / US / 29/773,604

[51] Cl. 24-02

[54] 手持式藥物遞送裝置

Handheld drug delivery device

[73] AMGEN INC.

One Amgen Center Drive,  
Thousand Oaks, CA 91320-1799,  
United States of America

[74] CHINA PATENT AGENT (HONG KONG) LIMITED

22/F, Great Eagle Centre,  
23 Harbour Road,  
Wanchai, Hong Kong



[11] 2118644.0M003

[15] 09-09-2021

[30] 10-03-2021 / US / 29/773,604

[51] C1. 24-02

[54] 手持式藥物遞送裝置

Handheld drug delivery device

[73] AMGEN INC.

One Amgen Center Drive,  
Thousand Oaks, CA 91320-1799,  
United States of America

[74] CHINA PATENT AGENT (HONG KONG) LIMITED

22/F, Great Eagle Centre,  
23 Harbour Road,  
Wanchai, Hong Kong

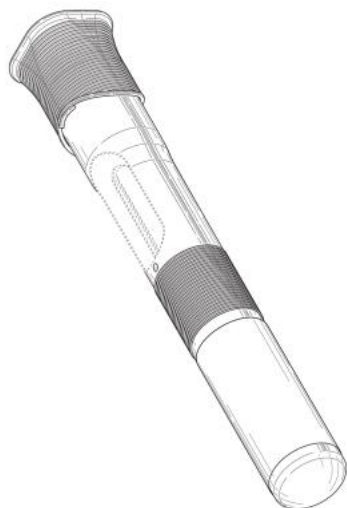

---

[11] 2118644.0M004

[15] 09-09-2021

[30] 10-03-2021 / US / 29/773,604

[51] C1. 24-02

[54] 手持式藥物遞送裝置

Handheld drug delivery device

[73] AMGEN INC.

One Amgen Center Drive,  
Thousand Oaks, CA 91320-1799,  
United States of America

[74] CHINA PATENT AGENT (HONG KONG) LIMITED

22/F, Great Eagle Centre,  
23 Harbour Road,  
Wanchai, Hong Kong

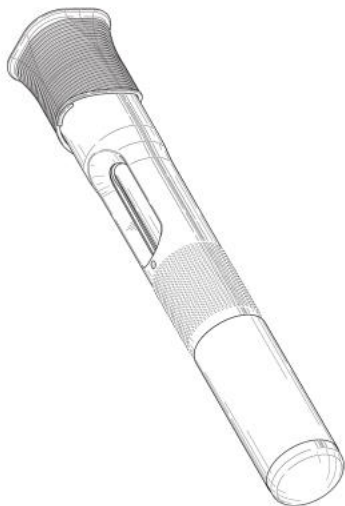

---

[11] 2118644.0M005

[15] 09-09-2021

[30] 10-03-2021 / US / 29/773,604

[51] Cl. 24-02

[54] 手持式藥物遞送裝置

Handheld drug delivery device

[73] AMGEN INC.

One Amgen Center Drive,  
Thousand Oaks, CA 91320-1799,  
United States of America

[74] CHINA PATENT AGENT (HONG KONG) LIMITED

22/F, Great Eagle Centre,  
23 Harbour Road,  
Wanchai, Hong Kong

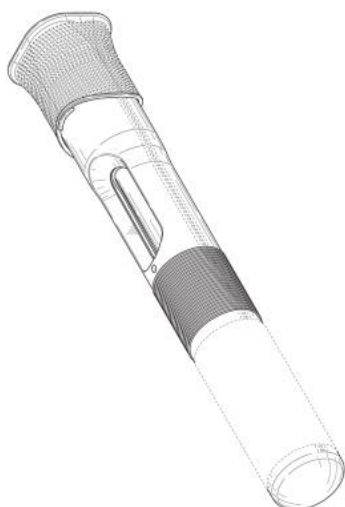

[11] 2118644.0M006

[15] 09-09-2021

[30] 10-03-2021 / US / 29/773,604

[51] Cl. 24-02

[54] 手持式藥物遞送裝置

Handheld drug delivery device

[73] AMGEN INC.

One Amgen Center Drive,  
Thousand Oaks, CA 91320-1799,  
United States of America

[74] CHINA PATENT AGENT (HONG KONG) LIMITED

22/F, Great Eagle Centre,  
23 Harbour Road,  
Wanchai, Hong Kong

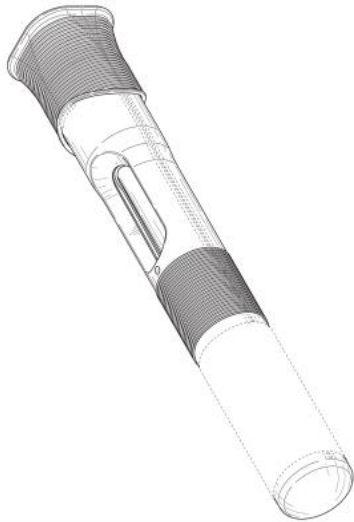

---

[11] 2118644.0M007

[15] 09-09-2021

[30] 10-03-2021 / US / 29/773,604

[51] Cl. 24-02

[54] 手持式藥物遞送裝置

Handheld drug delivery device

[73] AMGEN INC.

One Amgen Center Drive,  
Thousand Oaks, CA 91320-1799,  
United States of America

[74] CHINA PATENT AGENT (HONG KONG) LIMITED

22/F, Great Eagle Centre,  
23 Harbour Road,  
Wanchai, Hong Kong

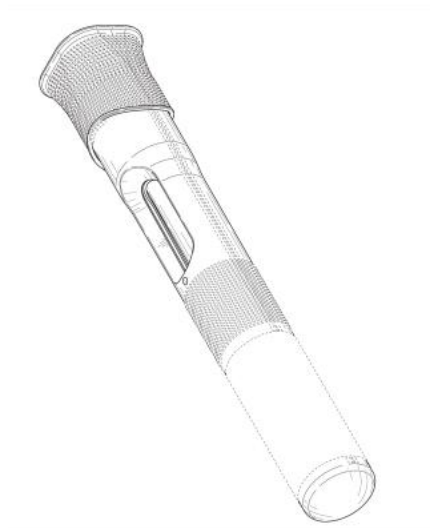

[11] 2118653.9M001

[15] 09-09-2021

[30] 22-03-2021 / JP / 005875 of 2021

[51] Cl. 6-09

[54] 頸枕

Neck pillow

[73] 花王株式會社

Kao Kabushiki Kaisha (Kao Corporation)

14-10, Nihonbashi Kayaba-cho 1-chome,

Chuo-ku, Tokyo,

Japan

[74] CHINAHONGKONG PATENT LIMITED

1502, 15/F, Capital Centre,

151 Gloucester Road,

Wanchai, Hong Kong

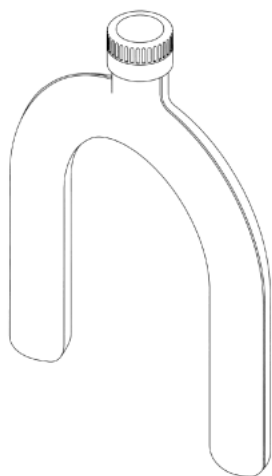

[11] 2118653.9M002

[15] 09-09-2021

[30] 22-03-2021 / JP / 005876 of 2021

[51] Cl. 6-09

[54] 頸枕

Neck pillow

[73] 花王株式會社

Kao Kabushiki Kaisha (Kao Corporation)

14-10, Nihonbashi Kayaba-cho 1-chome,

Chuo-ku, Tokyo,

Japan

[74] CHINAHONGKONG PATENT LIMITED

1502, 15/F, Capital Centre,

151 Gloucester Road,

Wanchai, Hong Kong

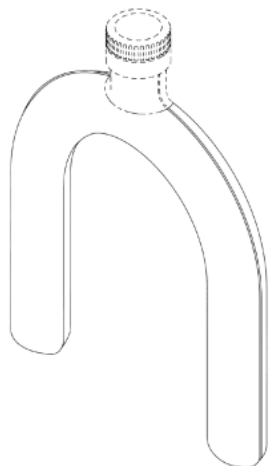

---

[11] 2118653.9M003

[15] 09-09-2021

[30] 22-03-2021 / JP / 005879 of 2021

[51] Cl. 6-09

[54] 頸枕

Neck pillow

[73] 花王株式會社

Kao Kabushiki Kaisha (Kao Corporation)

14-10, Nihonbashi Kayaba-cho 1-chome,

Chuo-ku, Tokyo,

Japan

[74] CHINAHONGKONG PATENT LIMITED

1502, 15/F, Capital Centre,

151 Gloucester Road,  
Wanchai, Hong Kong

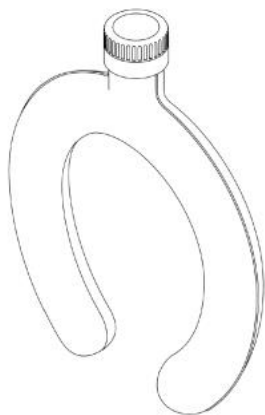

[11] 2118653.9M004

[15] 09-09-2021

[51] Cl. 6-09

[54] 頸枕

Neck pillow

[73] 花王株式會社

Kao Kabushiki Kaisha (Kao Corporation)

14-10, Nihonbashi Kayaba-cho 1-chome,

Chuo-ku, Tokyo,

Japan

[74] CHINAHONGKONG PATENT LIMITED

1502, 15/F, Capital Centre,

151 Gloucester Road,

Wanchai, Hong Kong

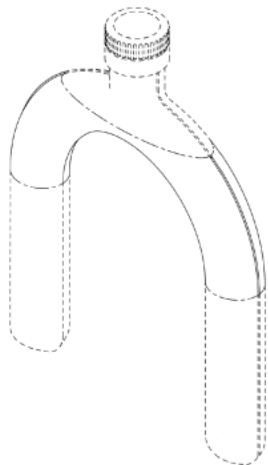

[11] 2118653.9M005

[15] 09-09-2021

[51] Cl. 6-09

[54] 頸枕

Neck pillow

[73] 花王株式會社

Kao Kabushiki Kaisha (Kao Corporation)

14-10, Nihonbashi Kayaba-cho 1-chome,

Chuo-ku, Tokyo,

Japan

[74] CHINAHONGKONG PATENT LIMITED

1502, 15/F, Capital Centre,

151 Gloucester Road,

Wanchai, Hong Kong

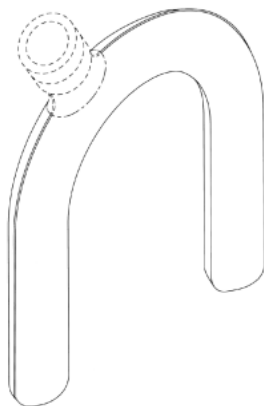

---

[11] 2118653.9M006

[15] 09-09-2021

[51] Cl. 6-09

[54] 頸枕

Neck pillow

[73] 花王株式會社

Kao Kabushiki Kaisha (Kao Corporation)

14-10, Nihonbashi Kayaba-cho 1-chome,

Chuo-ku, Tokyo,

Japan

[74] CHINAHONGKONG PATENT LIMITED

1502, 15/F, Capital Centre,



151 Gloucester Road,  
Wanchai, Hong Kong

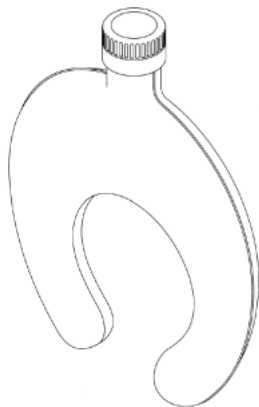

---

[11] 2118659.2

[15] 10-09-2021

[30] 07-07-2021 / MA, NO, OM, SG, CH, TN, TR, UA, GB, EU, AL /  
DM/215 247

[51] Cl. 10-02

[54] 手錶

Wristwatch

[73] SWATCH AG (SWATCH SA) (SWATCH LTD.)

Nicolas G. Hayek Strasse 1,  
2502 Biel/Bienne,  
Switzerland

[74] SPRUSON & FERGUSON (HONG KONG) LIMITED

5001 Hopewell Centre,  
183 Queen's Road East,  
Wan Chai, Hong Kong



---

[11] 2118660.4M001

- [15] 10-09-2021
- [30] 07-07-2021 / MA, NO, OM, SG, CH, TN, TR, UA, GB, EU, AL /  
DM/215 251
- [51] Cl. 10-02
- [54] 手錶  
Wristwatch
- [73] SWATCH AG (SWATCH SA) (SWATCH LTD.)  
Nicolas G. Hayek Strasse 1,  
2502 Biel/Bienne,  
Switzerland
- [74] SPRUSON & FERGUSON (HONG KONG) LIMITED  
5001 Hopewell Centre,  
183 Queen's Road East,  
Wan Chai, Hong Kong



- 
- [11] 2118660.4M002
- [15] 10-09-2021
- [30] 07-07-2021 / MA, NO, OM, SG, CH, TN, TR, UA, GB, EU, AL /  
DM/215 251
- [51] Cl. 10-02
- [54] 手錶  
Wristwatch
- [73] SWATCH AG (SWATCH SA) (SWATCH LTD.)  
Nicolas G. Hayek Strasse 1,  
2502 Biel/Bienne,  
Switzerland
- [74] SPRUSON & FERGUSON (HONG KONG) LIMITED  
5001 Hopewell Centre,  
183 Queen's Road East,  
Wan Chai, Hong Kong



---

[11] 2118667.9M001

[15] 13-09-2021

[51] Cl. 13-02

[54] 充電樁

Charging station

[73] Harvest Elite International Limited

Unit 12, 6/F, Kwai Cheong Centre,

50 Kwai Cheong Road,

Kwai Hing, N.T., Hong Kong

[74] HONG KONG INTELLECTUAL PROPERTY AGENT LIMITED

Unit 230, 2/F, Building 12W,

No. 12 Science Park West Avenue,

Phase 3, Hong Kong Science Park,

Pak Shek Kok, N.T., Hong Kong



---

[11] 2118667.9M002

[15] 13-09-2021

[51] Cl. 13-02

[54] 電池

Battery

- [73] Harvest Elite International Limited  
Unit 12, 6/F, Kwai Cheong Centre,  
50 Kwai Cheong Road,  
Kwai Hing, N.T., Hong Kong
- [74] HONG KONG INTELLECTUAL PROPERTY AGENT LIMITED  
Unit 230, 2/F, Building 12W,  
No. 12 Science Park West Avenue,  
Phase 3, Hong Kong Science Park,  
Pak Shek Kok, N.T., Hong Kong

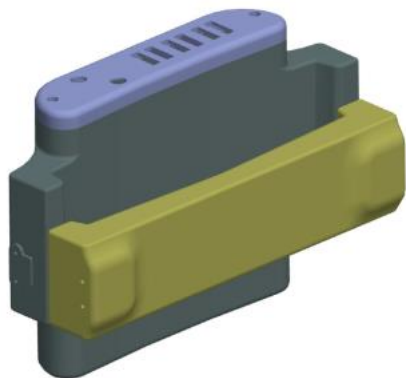

- 
- [11] 2118668.1M001
- [15] 13-09-2021
- [51] Cl. 15-99
- [54] 機械臂  
Robotic arm
- [73] Harvest Elite International Limited  
Unit 12, 6/F, Kwai Cheong Centre,  
50 Kwai Cheong Road,  
Kwai Hing, N.T., Hong Kong
- [74] HONG KONG INTELLECTUAL PROPERTY AGENT LIMITED  
Unit 230, 2/F, Building 12W,  
No. 12 Science Park West Avenue,  
Phase 3, Hong Kong Science Park,  
Pak Shek Kok, N.T., Hong Kong



---

[11] 2118668.1M002

[15] 13-09-2021

[51] Cl. 15-99

[54] 機械臂的底座

Base for robotic arm

[73] Harvest Elite International Limited

Unit 12, 6/F, Kwai Cheong Centre,  
50 Kwai Cheong Road,  
Kwai Hing, N.T., Hong Kong

[74] HONG KONG INTELLECTUAL PROPERTY AGENT LIMITED

Unit 230, 2/F, Building 12W,  
No. 12 Science Park West Avenue,  
Phase 3, Hong Kong Science Park,  
Pak Shek Kok, N.T., Hong Kong

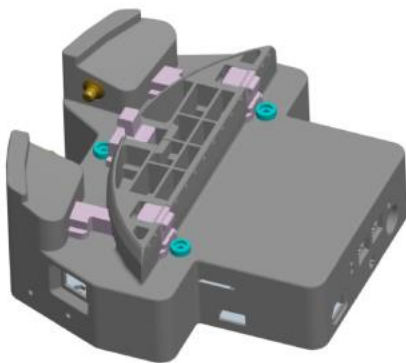

---

[11] 2118672.9

[15] 14-09-2021

- [30] 14-04-2021 / CN / 202130211180.9
- [51] Cl. 12-11
- [54] 電動摩托車  
Electric motorcycle
- [73] Sharkgulf Technology (Shanghai) CO., LTD  
Room J1707, Building 6, No. 1288,  
Yecheng Road, Jiading District,  
Shanghai, China
- [74] HONG KONG INTELLECTUAL PROPERTY AGENT LIMITED  
Unit 230, 2/F, Building 12W,  
No. 12 Science Park West Avenue,  
Phase 3, Hong Kong Science Park,  
Pak Shek Kok, N.T., Hong Kong



- 
- [11] 2118673.1
- [15] 14-09-2021
- [30] 06-04-2021 / KR / 30-2021-0016565
- [51] Cl. 27-07
- [54] 電子煙  
Electronic cigarette
- [73] KT&G Corporation  
71, Beotkkot-gil,  
Daedeok-gu, Daejeon,  
Korea, Republic of
- [74] MARKS & CLERK  
Level 9, Cyberport 1,  
100 Cyberport Road,  
Pok Fu Lam, Hong Kong

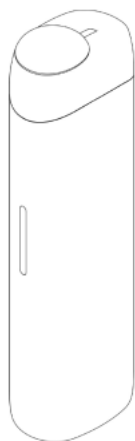

---

[11] 2118695.8

[15] 16-09-2021

[30] 17-03-2021 / CN / 202130144434.X

[51] Cl. 21-01

[54] 滑板車  
Scooter

[73] 北京小米移動軟件有限公司  
Beijing Xiaomi Mobile Software Co., Ltd.  
中國內地  
北京市海澱區西二旗中路 33 號院  
6 號樓 8 層 018 號

[74] 隆天專利商標代理有限公司  
香港  
長沙灣青山道 485 號  
九龍廣場 10 樓 11 室





香港特別行政區政府知識產權署外觀設計註冊處

The Government of the Hong Kong Special Administrative Region

Designs Registry, Intellectual Property Department

根據註冊外觀設計條例第 28 條，下列註冊外觀設計因未繳續期費而停止有效。

各組記項按註冊外觀設計停止有效日期及註冊編號先後次序排列。

**Registered designs ceased through non-payment of renewal fees under section 28 of the Registered Designs Ordinance. Entries are listed below under their expiry dates.**

**18-09-2021 - 22-09-2021**

<b>18-09-2021</b>	1601796.6M002	1601815.8
0602420.8	1601797.8	
1101605.8	1601798.0	
1601782.6	1601800.6M001	
1601785.3	1601800.6M002	
	1601801.8M001	
<b>19-09-2021</b>	1601801.8M002	
1101608.4	1601802.0M001	
1101610.8M001	1601802.0M002	
1101610.8M002	1601802.0M003	
1101610.8M003	1601802.0M004	
1101610.8M004		
1101610.8M005	<b>21-09-2021</b>	
1101610.8M006	0602450.1M001	
1101610.8M007	0602450.1M002	
1101610.8M008		
1101610.8M009	<b>22-09-2021</b>	
1101610.8M010	1101640.1	
1101611.0	1101641.3M001	
1101612.2	1101641.3M002	
1601786.5M001	1101645.2M002	
1601786.5M002	1101645.2M003	
1601787.7	1101647.6	
1601788.9M001	1601809.5M001	
1601788.9M002	1601809.5M002	
1601791.5	1601809.5M003	
	1601810.7	
<b>20-09-2021</b>	1601811.9	
0111428.1	1601812.1	
0602440.0	1601814.5M001	
1101623.5	1601814.5M002	
1101624.7	1601814.5M003	
1101631.2	1601814.5M004	
1601796.6M001	1601814.5M005	





香港特別行政區政府知識產權署外觀設計註冊處

The Government of the Hong Kong Special Administrative Region

Designs Registry, Intellectual Property Department

根據註冊外觀設計規則第 31 條刪除的註冊外觀設計。各組記項按註冊外觀設計刪除日期及註冊編號先後次序排列。

**Registered designs removed under section 31 of the Registered Designs Rules. Entries are listed below under their removal dates.**

**15-10-2021 - 21-10-2021**

<b>15-10-2021</b>	1100452.0	1600497.0M008
1100438.1M001	1600476.6	1600497.0M009
1100438.1M002	1600481.6M001	1600497.0M010
1100438.1M003	1600481.6M002	1600497.0M011
1100438.1M004	1600481.6M003	1600497.0M012
1100443.1M007	1600483.0	1600498.2M001
1100443.1M008	1600484.2	1600498.2M002
1100443.1M009		1600499.4M001
1600464.0M001	<b>18-10-2021</b>	1600499.4M002
1600464.0M002	0110397.3	1600499.4M003
1600464.0M003	0110398.5M001	1600499.4M004
1600464.0M004	0110398.5M002	
1600464.0M005	0110398.5M003	<b>20-10-2021</b>
1600464.0M006	0110398.5M004	0600710.2
1600464.0M007	0600674.4	0600716.5M001
1600464.0M008	0600675.7	0600716.5M002
1600464.0M009		1100461.9
1600464.0M010	<b>19-10-2021</b>	1600505.0M001
1600464.0M011	0600682.1	1600505.0M002
1600466.5	1100456.9	1600506.2
1600467.7	1600491.7M001	1600507.4
1600468.9	1600491.7M002	1600509.8
1600469.1	1600491.7M003	1600511.2
1600470.3	1600491.7M004	1600512.4
1600471.5	1600491.7M005	1600514.8
1600472.7	1600495.6	
1600473.9	1600496.8	<b>21-10-2021</b>
1600474.1	1600497.0M001	1100466.0M004
1600475.4	1600497.0M002	1100466.0M005
	1600497.0M003	1600520.1M001
<b>16-10-2021</b>	1600497.0M004	1600520.1M002
0600667.0	1600497.0M005	1600520.1M003
1100449.4	1600497.0M006	1600520.1M004
1100450.6	1600497.0M007	