

# 香港知識產權公報

Hong Kong Intellectual Property Journal

2020年11月6日  
06 November 2020

## 目錄 Contents

### 根據註冊外觀設計條例第 25 條註冊的外觀設計

#### **Designs Registered under section 25 of the Registered Designs Ordinance**

按註冊編號排列

Arranged by Registration Number

### 根據註冊外觀設計條例(第 522 章)公布的其他公告

#### **Other Notices Published under the Registered Designs Ordinance (Cap. 522)**

根據註冊外觀設計條例第 28 條，註冊外觀設計因未繳續期費而停止有效

Registered designs ceased through non-payment of renewal fees under section 28 of the Registered Designs Ordinance

根據註冊外觀設計條例第 30 條放棄的外觀設計的註冊

Surrender of Registration of Design under section 30 of the Registered Designs Ordinance

根據註冊外觀設計規則第 31 條刪除的註冊外觀設計

Registered designs removed under section 31 of the Registered Designs Rules

根據註冊外觀設計條例第 67 及 76 條，更正註冊紀錄冊內及已提交文件中的錯誤

Correction of Errors in Register and in Filed Documents under sections 67 and 76 of the Registered Designs Ordinance

根據註冊外觀設計條例第 76 條，更正已提交文件中的錯誤

Correction of errors in filed documents under section 76 of the Registered Designs Ordinance

## 以下事項沒有記錄

### **No Records for the Following Matters**

根據註冊外觀設計規則第 37 條，向處長作出轉介

Reference to Registrar under section 37 of the Registered Designs Rules

根據註冊外觀設計條例第 45 條，撤銷註冊

Revocation of Registration under section 45 of the Registered Designs Ordinance

根據註冊外觀設計規則第 46 條，向法院作出轉介

Reference to Court under section 46 of the Registered Designs Rules

根據註冊外觀設計規則第 63 條對不符合規定之處作出糾正

Rectification of Irregularities under section 63 of the Registered Designs Rules

根據註冊外觀設計條例第 66 條，糾正註冊紀錄冊

Rectification of Register under section 66 of the Registered Designs Ordinance

根據註冊外觀設計條例第 67 條 更正註冊紀錄冊內的錯誤

Correction of errors in Register under section 67 of the Registered Designs Ordinance

根據註冊外觀設計條例第 67 及 76 條，更正註冊紀錄冊內及已提交文件中的錯誤

Correction of Errors in Register and in Filed Documents under sections 67 and 76 of the Registered Designs Ordinance

根據註冊外觀設計條例第 76 條，更正已提交文件中的錯誤

Correction of errors in filed documents under section 76 of the Registered Designs Ordinance

勘誤

Corrigendum

## 註冊外觀設計公告註釋

### Notes on advertisements of registration of designs

方括號表示下列資料：

Square brackets indicate the following data：

[11] 註冊編號 Registration number / 聯合王國註冊編號 United Kingdom registration number

[15] 註冊日期 Registration date / 當作註冊日期 Deemed registration date / 聯合王國註冊日期 United Kingdom registration date

[17] 註冊有效期屆滿日期 Expiry date of the period of registration

[22] 提交日期 Filing date / 當作提交日期 Deemed filing date / 聯合王國提交日期 United Kingdom filing date

[30] 聲稱享有的優先權（提交日期 / 巴黎公約國或世界貿易組織成員 / 申請編號） Priority claimed (filing date / Paris Convention country or WTO member / application number)

[51] 國際外觀設計分類號（洛迦諾分類號） International Classification of designs (Locarno Classification)

[54] 物品 Article

[55] 外觀設計的表述 Representation of the design

[62] 分開前的申請編號及提交日期 Application number before division and filing date

[66] 過往註冊的聯繫外觀設計註冊編號 / 日期 Registration No. / Date of Previous Registration for Association

[72] 設計人 Designer

[73] 擁有人姓名和地址 Name and address of the owner

[74] 代理人 Agent / 送達地址 Address for service



香港特別行政區政府知識產權署外觀設計註冊處

The Government of the Hong Kong Special Administrative Region

Designs Registry, Intellectual Property Department

## 根據註冊外觀設計條例第 25 條註冊的外觀設計

### Designs registered under section 25 of the Registered Designs Ordinance

按註冊編號排列

Arranged by Registration Number

[11] 1914319.3M001

[15] 25-07-2019

[30] 25-01-2019 / US / 29/678,108

[51] Cl. 28-03

[54] 皮膚按摩器

Skin massager

[73] Filip Sedic

Room 1711-1720

75 South Wanping Road, Shanghai 200032

CHINA

[74] UNITALEN ATTORNEYS AT LAW LIMITED

RM 1201, 12/F,

GOLDEN ERA PLAZA,

39-55 SAI YEE ST, MONGKOK KLN

HONG KONG



[11] 1914319.3M002

- [15] 25-07-2019
- [30] 25-01-2019 / US / 29/678,108
- [51] Cl. 28-03
- [54] 皮膚按摩器  
Skin massager
- [73] Filip Sedic  
Room 1711-1720  
75 South Wanping Road, Shanghai 200032  
CHINA
- [74] UNITALEN ATTORNEYS AT LAW LIMITED  
RM 1201, 12/F,  
GOLDEN ERA PLAZA,  
39-55 SAI YEE ST, MONGKOK KLN  
HONG KONG



- 
- [11] 1914319.3M003
  - [15] 25-07-2019
  - [30] 25-01-2019 / US / 29/678,108
  - [51] Cl. 28-03
  - [54] 皮膚按摩器  
Skin massager
  - [73] Filip Sedic  
Room 1711-1720  
75 South Wanping Road, Shanghai 200032  
CHINA
  - [74] UNITALEN ATTORNEYS AT LAW LIMITED  
RM 1201, 12/F,  
GOLDEN ERA PLAZA,  
39-55 SAI YEE ST, MONGKOK KLN  
HONG KONG



---

[11] 1914319.3M004

[15] 25-07-2019

[30] 25-01-2019 / US / 29/678,108

[51] Cl. 28-03

[54] 皮膚按摩器  
Skin massager

[73] Filip Sedic  
Room 1711-1720  
75 South Wanping Road, Shanghai 200032  
CHINA

[74] UNITALEN ATTORNEYS AT LAW LIMITED  
RM 1201, 12/F,  
GOLDEN ERA PLAZA,  
39-55 SAI YEE ST, MONGKOK KLN  
HONG KONG





[11] 1914319.3M005

[15] 25-07-2019

[30] 25-01-2019 / US / 29/678,108

[51] Cl. 28-03

[54] 皮膚按摩器

Skin massager

[73] Filip Sedic

Room 1711-1720

75 South Wanping Road, Shanghai 200032

CHINA

[74] UNITALEN ATTORNEYS AT LAW LIMITED

RM 1201, 12/F,

GOLDEN ERA PLAZA,

39-55 SAI YEE ST, MONGKOK KLN

HONG KONG

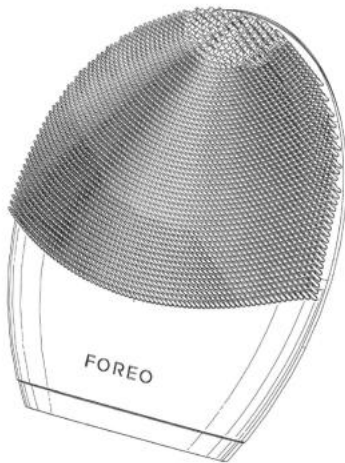

---

[11] 1914319.3M006

[15] 25-07-2019

[30] 25-01-2019 / US / 29/678,108

[51] Cl. 28-03

[54] 皮膚按摩器

Skin massager

[73] Filip Sedic

Room 1711-1720

75 South Wanping Road, Shanghai 200032

CHINA

[74] UNITALEN ATTORNEYS AT LAW LIMITED

RM 1201, 12/F,

GOLDEN ERA PLAZA,

39-55 SAI YEE ST, MONGKOK KLN

HONG KONG



---

[11] 1914319.3M007

[15] 25-07-2019

[30] 25-01-2019 / US / 29/678,108

[51] Cl. 28-03

[54] 皮膚按摩器

Skin massager

[73] Filip Sedic

Room 1711-1720

75 South Wanping Road, Shanghai 200032

CHINA

[74] UNITALEN ATTORNEYS AT LAW LIMITED

RM 1201, 12/F,

GOLDEN ERA PLAZA,

39-55 SAI YEE ST, MONGKOK KLN

HONG KONG



---

[11] 1914319.3M008

[15] 25-07-2019

[30] 25-01-2019 / US / 29/678,108

[51] Cl. 28-03

[54] 皮膚按摩器

Skin massager

[73] Filip Sedic

Room 1711-1720

75 South Wanping Road, Shanghai 200032

CHINA

[74] UNITALEN ATTORNEYS AT LAW LIMITED

RM 1201, 12/F,

GOLDEN ERA PLAZA,

39-55 SAI YEE ST, MONGKOK KLN

HONG KONG



---

[11] 1914319.3M009

[15] 25-07-2019

[30] 25-01-2019 / US / 29/678,108

[51] Cl. 28-03

[54] 皮膚按摩器

Skin massager

[73] Filip Sedic

Room 1711-1720

75 South Wanping Road, Shanghai 200032

CHINA

[74] UNITALEN ATTORNEYS AT LAW LIMITED

RM 1201, 12/F,

GOLDEN ERA PLAZA,

39-55 SAI YEE ST, MONGKOK KLN

HONG KONG

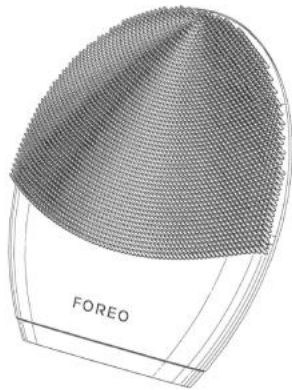

---

[11] 1914319.3M010

[15] 25-07-2019

[30] 25-01-2019 / US / 29/678,108

[51] Cl. 28-03

[54] 皮膚按摩器

Skin massager

[73] Filip Sedic

Room 1711-1720

75 South Wanping Road, Shanghai 200032

CHINA

[74] UNITALEN ATTORNEYS AT LAW LIMITED

RM 1201, 12/F,

GOLDEN ERA PLAZA,

39-55 SAI YEE ST, MONGKOK KLN

HONG KONG



---

[11] 1914319.3M011

[15] 25-07-2019

[30] 25-01-2019 / US / 29/678,108

[51] Cl. 28-03

[54] 皮膚按摩器

Skin massager

[73] Filip Sedic

Room 1711-1720

75 South Wanping Road, Shanghai 200032

CHINA

[74] UNITALEN ATTORNEYS AT LAW LIMITED

RM 1201, 12/F,

GOLDEN ERA PLAZA,

39-55 SAI YEE ST, MONGKOK KLN

HONG KONG



---

[11] 1914319.3M012

[15] 25-07-2019

[30] 25-01-2019 / US / 29/678,108

[51] Cl. 28-03

[54] 皮膚按摩器

Skin massager

[73] Filip Sedic

Room 1711-1720

75 South Wanping Road, Shanghai 200032

CHINA

[74] UNITALEN ATTORNEYS AT LAW LIMITED

RM 1201, 12/F,

GOLDEN ERA PLAZA,

39-55 SAI YEE ST, MONGKOK KLN

HONG KONG



---

[11] 2016002.6M001

[15] 17-04-2020

[30] 17-10-2019 / EU / 007040613

[51] Cl. 27-99

[54] 氣霧產生裝置

Aerosol generating device

[73] Philip Morris Products S.A.

Quai Jeanrenaud 3,

CH-2000 Neuchâtel,

SWITZERLAND

[74] CLT PATENT & TRADEMARK (H.K.) LIMITED

Unit 09, 34/F., Office Tower, Convention Plaza,

No. 1 Harbour Road,

Wanchai. Hong Kong



---

[11] 2016002.6M002

[15] 17-04-2020

[30] 17-10-2019 / EU / 007040613

[51] Cl. 27-99

[54] 氣霧產生裝置

Aerosol generating device

[73] Philip Morris Products S.A.

Quai Jeanrenaud 3,  
CH-2000 Neuchâtel,  
SWITZERLAND

[74] CLT PATENT & TRADEMARK (H.K.) LIMITED

Unit 09, 34/F., Office Tower, Convention Plaza,  
No. 1 Harbour Road,  
Wanchai. Hong Kong



---

[11] 2016002.6M003

[15] 17-04-2020

[30] 17-10-2019 / EU / 007040613

[51] Cl. 27-99

[54] 氣霧產生裝置

Aerosol generating device

[73] Philip Morris Products S.A.

Quai Jeanrenaud 3,  
CH-2000 Neuchâtel,  
SWITZERLAND

[74] CLT PATENT & TRADEMARK (H.K.) LIMITED

Unit 09, 34/F., Office Tower, Convention Plaza,  
No. 1 Harbour Road,  
Wanchai. Hong Kong



---

[11] 2016002.6M004

[15] 17-04-2020

[30] 17-10-2019 / EU / 007040613

[51] Cl. 27-99

[54] 氣霧產生裝置的部分

Part of aerosol generating device

[73] Philip Morris Products S.A.

Quai Jeanrenaud 3,

CH-2000 Neuchâtel,

SWITZERLAND

[74] CLT PATENT & TRADEMARK (H.K.) LIMITED

Unit 09, 34/F., Office Tower, Convention Plaza,

No. 1 Harbour Road,

Wanchai. Hong Kong

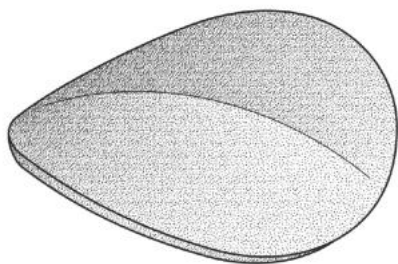

---

[11] 2016002.6M005

[15] 17-04-2020

[30] 17-10-2019 / EU / 007040613



[51] Cl. 27-99

[54] 氣霧產生裝置的部分

Part of aerosol generating device

[73] Philip Morris Products S.A.

Quai Jeanrenaud 3,

CH-2000 Neuchâtel,

SWITZERLAND

[74] CLT PATENT & TRADEMARK (H.K.) LIMITED

Unit 09, 34/F., Office Tower, Convention Plaza,

No. 1 Harbour Road,

Wanchai. Hong Kong

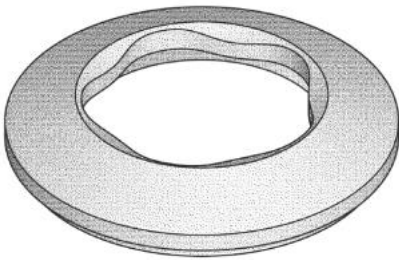

---

[11] 2016146.1M001

[15] 14-05-2020

[30] 09-01-2020 / AM, AZ, BZ, BA, GE, LI, MK, MD, MC, MN, ME, MA,  
NO, OM, SG, CH, TN, TR, UA, GB, EU, AL, KG / DM/205 974

[51] Cl. 10-02

[54] 錶

Watch

[73] MONTRES BREGUET SA (MONTRES BREGUET AG (MONTRES BREGUET LTD)

Ch-1344 L'abbaye,

Switzerland

[74] SPRUSON & FERGUSON (HONG KONG) LIMITED

5001 Hopewell Centre,

183 Queen's Road East,

Wan Chai. Hong Kong



[11] 2016146.1M002

[15] 14-05-2020

[30] 09-01-2020 / AM, AZ, BZ, BA, GE, LI, MK, MD, MC, MN, ME, MA,  
NO, OM, SG, CH, TN, TR, UA, GB, EU, AL, KG / DM/205 974

[51] Cl. 10-02

[54] 錶

Watch

[73] MONTRES BREGUET SA (MONTRES BREGUET AG (MONTRES BREGUET LTD)  
Ch-1344 L'abbaye,  
Switzerland

[74] SPRUSON & FERGUSON (HONG KONG) LIMITED  
5001 Hopewell Centre,  
183 Queen's Road East,  
Wan Chai. Hong Kong



---

[11] 2016146.1M003

[15] 14-05-2020

[30] 09-01-2020 / AM, AZ, BZ, BA, GE, LI, MK, MD, MC, MN, ME, MA,  
NO, OM, SG, CH, TN, TR, UA, GB, EU, AL, KG / DM/205 974

[51] Cl. 10-02

[54] 錶

Watch

[73] MONTRES BREGUET SA (MONTRES BREGUET AG (MONTRES BREGUET LTD)  
Ch-1344 L'abbaye,  
Switzerland

[74] SPRUSON & FERGUSON (HONG KONG) LIMITED  
5001 Hopewell Centre,  
183 Queen's Road East,  
Wan Chai. Hong Kong



---

[11] 2016278.0

[15] 04-06-2020

[30] 05-12-2019 / FR / 2019-5338

[51] Cl. 3-01

[54] 袋

Bag

[73] LOUIS VUITTON MALLETIER

2 rue du Pont-Neuf,

75001 Paris,

France

[74] BAKER & MCKENZIE

14th Floor, One Taikoo Place,

979 King's Road,

Quarry Bay, Hong Kong



---

[11] 2016312.3

[15] 10-06-2020

[51] Cl. 15-05

- [54] 玻璃清潔模塊  
Glass cleaning module
- [73] 奧馬迪機器人有限公司  
O-Matic Intelligent Robot Limited  
香港新界沙田  
香港科學園科技大道西 19 號  
19W 大樓 2 樓 227 室
- [74] 奧馬迪機器人有限公司  
香港新界沙田  
香港科學園科技大道西 19 號  
19W 大樓 2 樓 227 室

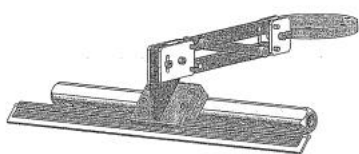

- 
- [11] 2016431.5M001
- [15] 03-07-2020
- [30] 03-01-2020 / US / 29/719,357
- [51] C1. 13-03
- [54] 電極陣列部件  
Electrode array
- [73] NOVOCURE GMBH  
Park 6, Root D4,  
CH-6039,  
Switzerland
- [74] CHINA PATENT AGENT (HONG KONG) LIMITED  
22/F, Great Eagle Centre,  
23 Harbour Road,  
Wanchai, Hong Kong

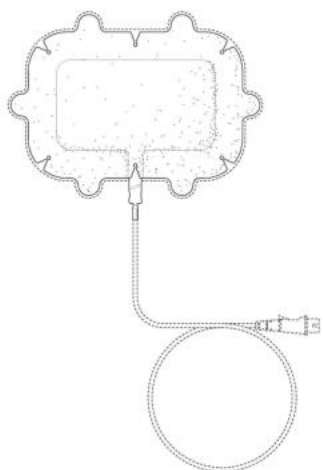

---

[11] 2016431.5M002

[15] 03-07-2020

[30] 03-01-2020 / US / 29/719,357

[51] Cl. 13-03

[54] 電極陣列部件

Electrode array

[73] NOVOCURE GMBH

Park 6, Root D4,

CH-6039,

Switzerland

[74] CHINA PATENT AGENT (HONG KONG) LIMITED

22/F, Great Eagle Centre,

23 Harbour Road,

Wanchai, Hong Kong

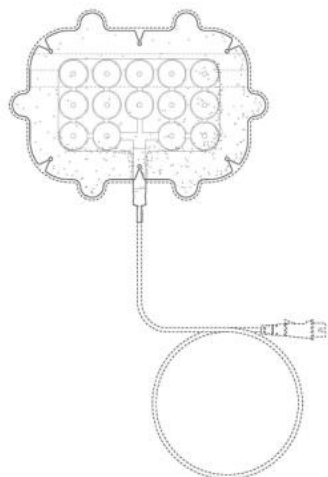

[11] 2016431.5M003

[15] 03-07-2020

[30] 03-01-2020 / US / 29/719,357

[51] Cl. 13-03

[54] 電極陣列部件

Electrode array

[73] NOVOCURE GMBH

Park 6, Root D4,

CH-6039,

Switzerland

[74] CHINA PATENT AGENT (HONG KONG) LIMITED

22/F, Great Eagle Centre,

23 Harbour Road,

Wanchai, Hong Kong

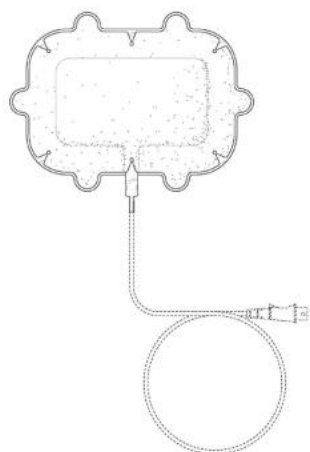

[11] 2016431.5M004

[15] 03-07-2020

[30] 03-01-2020 / US / 29/719,357

[51] Cl. 13-03

[54] 電極陣列部件

Electrode array

[73] NOVOCURE GMBH

Park 6, Root D4,

CH-6039,

Switzerland

[74] CHINA PATENT AGENT (HONG KONG) LIMITED

22/F, Great Eagle Centre,

23 Harbour Road,

Wanchai, Hong Kong

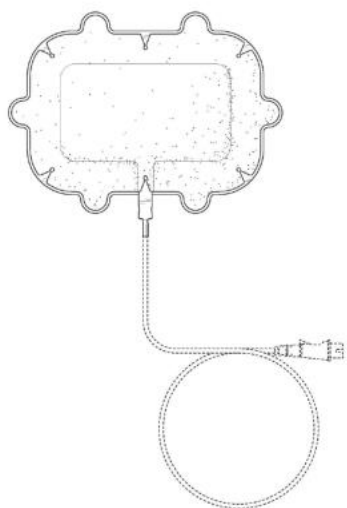

---

[11] 2016431.5M005

[15] 03-07-2020

[30] 03-01-2020 / US / 29/719,357

[51] Cl. 13-03

[54] 電極陣列部件

Electrode array

[73] NOVOCURE GMBH

Park 6, Root D4,

CH-6039,

Switzerland

[74] CHINA PATENT AGENT (HONG KONG) LIMITED

22/F, Great Eagle Centre,

23 Harbour Road,

Wanchai, Hong Kong

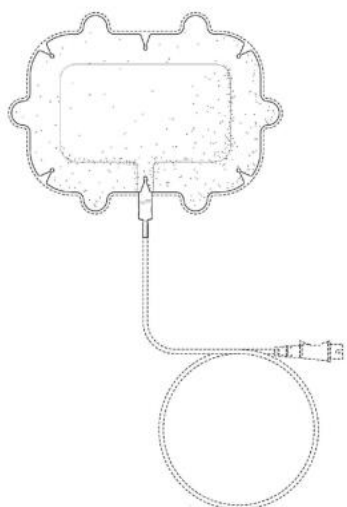

[11] 2016431.5M006

[15] 03-07-2020

[30] 03-01-2020 / US / 29/719,357

[51] Cl. 13-03

[54] 電極陣列部件

Electrode array

[73] NOVOCURE GMBH

Park 6, Root D4,

CH-6039,

Switzerland

[74] CHINA PATENT AGENT (HONG KONG) LIMITED

22/F, Great Eagle Centre,

23 Harbour Road,

Wanchai, Hong Kong

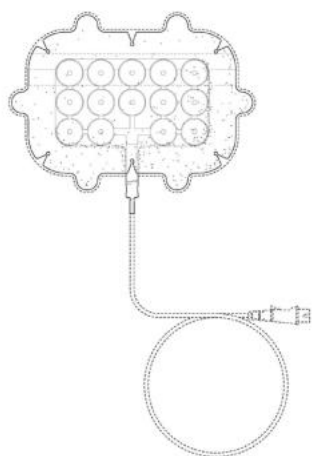

---

[11] 2016431.5M007

[15] 03-07-2020

[30] 03-01-2020 / US / 29/719,357

[51] Cl. 13-03

[54] 電極陣列部件

Electrode array

[73] NOVOCURE GMBH

Park 6, Root D4,

CH-6039,

Switzerland

[74] CHINA PATENT AGENT (HONG KONG) LIMITED

22/F, Great Eagle Centre,

23 Harbour Road,

Wanchai, Hong Kong



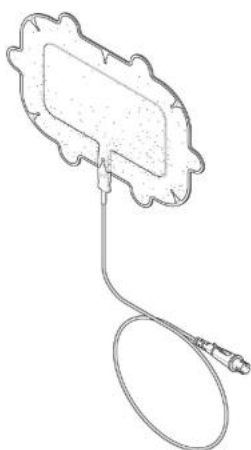

---

[11] 2016431.5M008

[15] 03-07-2020

[30] 03-01-2020 / US / 29/719,357

[51] Cl. 13-03

[54] 電極陣列部件

Electrode array

[73] NOVOCURE GMBH

Park 6, Root D4,

CH-6039,

Switzerland

[74] CHINA PATENT AGENT (HONG KONG) LIMITED

22/F, Great Eagle Centre,

23 Harbour Road,

Wanchai, Hong Kong

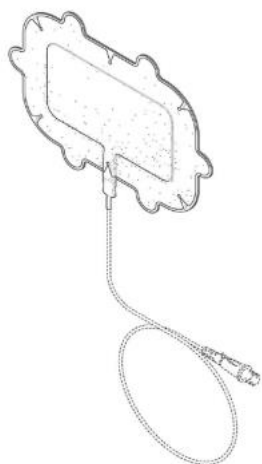

- [11] 2016447.9  
[15] 07-07-2020  
[30] 09-01-2020 / US / 29/720,111  
[51] Cl. 24-01  
[54] 進入設備  
Access device  
[73] Bausch Health Ireland Limited  
3013 Lake Drive, Citywest Business Campus, Dublin, Ireland 24,  
Ireland  
[74] LIU, SHEN & ASSOCIATES  
Room 3716, 37/F, Sun Hung Kai Centre,  
30 Harbour Road,  
Wanchai, Hong Kong

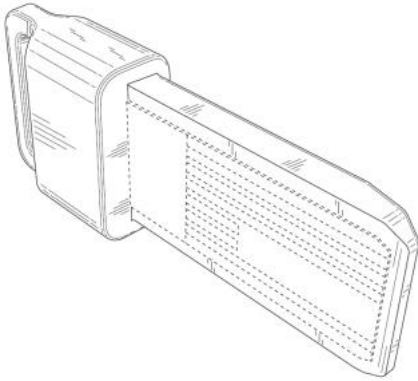

- 
- [11] 2016552.2M001  
[15] 22-07-2020  
[30] 27-01-2020 / US / 29/722,202  
[51] Cl. 19-08  
[54] 用於瓶子的標籤  
Label for vial  
[73] GENENTECH, INC.  
1 DNA Way, South San Francisco,  
California 94080-4990,  
United States  
[74] CHINAHONGKONG IP LIMITED  
3011, 30/F, Office Tower, Convention Plaza,  
1 Harbour Road,  
Hong Kong

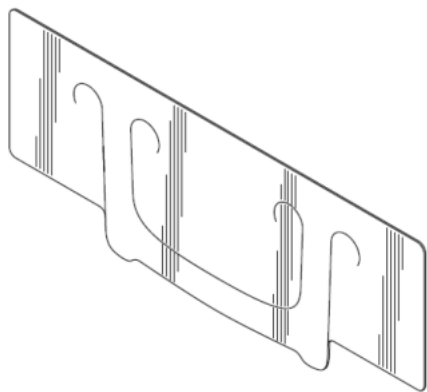

---

[11] 2016552.2M002

[15] 22-07-2020

[30] 27-01-2020 / US / 29/722,202

[51] Cl. 19-08

[54] 用於瓶子的標籤

Label for vial

[73] GENENTECH, INC.

1 DNA Way, South San Francisco,

California 94080-4990,

United States

[74] CHINAHONGKONG IP LIMITED

3011, 30/F, Office Tower, Convention Plaza,

1 Harbour Road,

Hong Kong

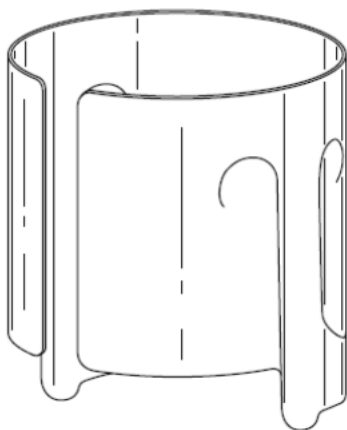

---

[11] 2016552.2M003

[15] 22-07-2020

[30] 27-01-2020 / US / 29/722,202

[51] Cl. 19-08

[54] 用於瓶子的標籤

Label for vial

[73] GENENTECH, INC.

1 DNA Way, South San Francisco,  
California 94080-4990,  
United States

[74] CHINAHONGKONG IP LIMITED

3011, 30/F, Office Tower, Convention Plaza,  
1 Harbour Road,  
Hong Kong

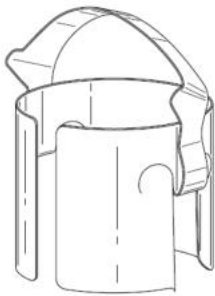

---

[11] 2016552.2M004

[15] 22-07-2020

[30] 27-01-2020 / US / 29/722,202

[51] Cl. 19-08

[54] 用於瓶子的標籤

Label for vial

[73] GENENTECH, INC.

1 DNA Way, South San Francisco,  
California 94080-4990,  
United States

[74] CHINAHONGKONG IP LIMITED

3011, 30/F, Office Tower, Convention Plaza,  
1 Harbour Road,  
Hong Kong

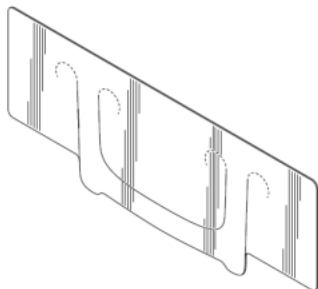

- [11] 2016552.2M005  
[15] 22-07-2020  
[30] 27-01-2020 / US / 29/722,202  
[51] Cl. 19-08  
[54] 用於瓶子的標籤  
Label for vial  
[73] GENENTECH, INC.  
1 DNA Way, South San Francisco,  
California 94080-4990,  
United States  
[74] CHINAHONGKONG IP LIMITED  
3011, 30/F, Office Tower, Convention Plaza,  
1 Harbour Road,  
Hong Kong

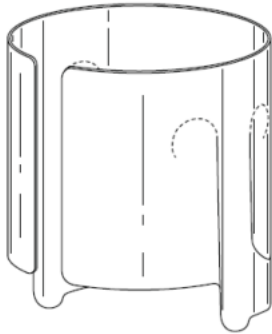

- 
- [11] 2016552.2M006  
[15] 22-07-2020  
[30] 27-01-2020 / US / 29/722,202  
[51] Cl. 19-08  
[54] 用於瓶子的標籤  
Label for vial  
[73] GENENTECH, INC.  
1 DNA Way, South San Francisco,  
California 94080-4990,  
United States  
[74] CHINAHONGKONG IP LIMITED  
3011, 30/F, Office Tower, Convention Plaza,  
1 Harbour Road,  
Hong Kong

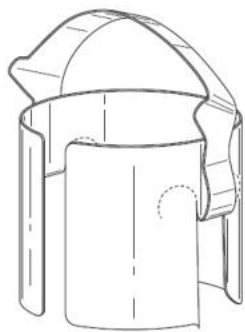

---

[11] 2016558.5M001

[15] 23-07-2020

[51] Cl. 9-05

[54] 包裝用容器

The container for a package

[73] 樂敦製藥株式會社

Rohto Pharmaceutical Co., Ltd.

8-1, Tatsuminishi 1-chome,

Ikuno-ku, Osaka-shi, Osaka,

Japan

[74] MARKS & CLERK

Level 9, Cyberport 1,

100 Cyberport Road,

Pok Fu Lam, Hong Kong



---

[11] 2016558.5M002

[15] 23-07-2020

[51] Cl. 9-05

[54] 包裝用容器  
The container for a package

[73] 樂敦製藥株式會社  
Rohto Pharmaceutical Co., Ltd.  
8-1, Tatsuminishi 1-chome,  
Ikuno-ku, Osaka-shi, Osaka,  
Japan

[74] MARKS & CLERK  
Level 9, Cyberport 1,  
100 Cyberport Road,  
Pok Fu Lam, Hong Kong



---

[11] 2016560.9M001

[15] 23-07-2020

[30] 24-01-2020 / US / 29/721,898

[51] Cl. 1-02

[54] 馬鈴薯切制食品  
Food cut from a potato

[73] 蘭博書斯頓有限責任公司  
Lamb Weston, Inc.  
599S. Rivershore Lane,  
Eagle, ID83616,  
United States

[74] MARKS & CLERK  
Level 9, Cyberport 1,  
100 Cyberport Road,  
Pok Fu Lam, Hong Kong

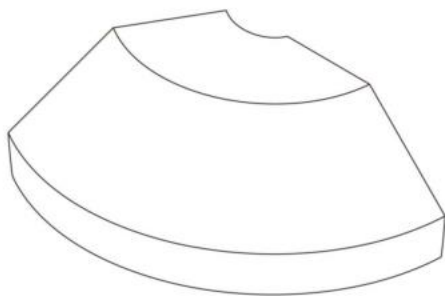

---

[11] 2016560.9M002

[15] 23-07-2020

[30] 24-01-2020 / US / 29/721,898

[51] Cl. 1-02

[54] 馬鈴薯切制食品

Food cut from a potato

[73] 蘭博書斯頓有限責任公司

Lamb Weston, Inc.

599S. Rivershore Lane,

Eagle, ID83616,

United States

[74] MARKS & CLERK

Level 9, Cyberport 1,

100 Cyberport Road,

Pok Fu Lam, Hong Kong

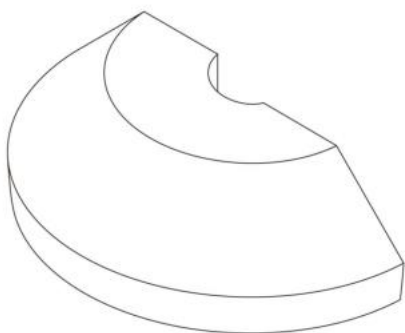

---

[11] 2016560.9M003

[15] 23-07-2020

[30] 24-01-2020 / US / 29/721,898

[51] Cl. 1-02

[54] 馬鈴薯切制食品

Food cut from a potato



- [73] 蘭博書斯頓有限責任公司  
Lamb Weston, Inc.  
599S. Rivershore Lane,  
Eagle, ID83616,  
United States
- [74] MARKS & CLERK  
Level 9, Cyberport 1,  
100 Cyberport Road,  
Pok Fu Lam, Hong Kong

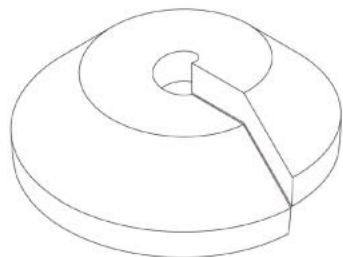

- 
- [11] 2016563.5
- [15] 24-07-2020
- [51] Cl. 9-05
- [54] 包裝袋  
Pouch of packaging
- [73] 卡萊美化妝品有限公司  
Colourmix Cosmetics Company Limited  
10th Floor, Wyler Centre Phase II,  
192-200 Tai Lin Pai Road,  
Kwai Chung, New Territories, Hong Kong
- [74] MARKPAL IP LIMITED  
Unit A, 11/F Amtel Building,  
144-148 Des Voeux Road Central,  
Hong Kong



[11] 2016564.7M001

[15] 27-07-2020

[30] 10-03-2020 / MA, RS, SG, CH, TR, UA, US, EU, KR / DM/206 964

[51] Cl. 11-01

[54] 戒指  
Ring

[73] CHOPARD INTERNATIONAL SA  
Route de Promenthoux,  
1197 Prangins,  
Switzerland

[74] WILKINSON & GRIST  
6th Floor, Prince's Building,  
Chater Road,  
Hong Kong

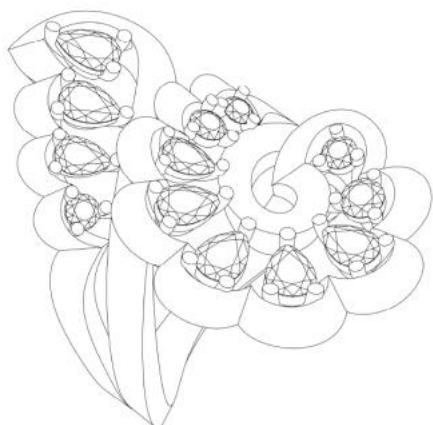

[11] 2016564.7M002

[15] 27-07-2020

[30] 10-03-2020 / MA, RS, SG, CH, TR, UA, US, EU, KR / DM/206 966

[51] Cl. 11-01

[54] 首飾元件

Jewelry element

[73] CHOPARD INTERNATIONAL SA

Route de Promenthoux,

1197 Prangins,

Switzerland

[74] WILKINSON & GRIST

6th Floor, Prince's Building,

Chater Road,

Hong Kong

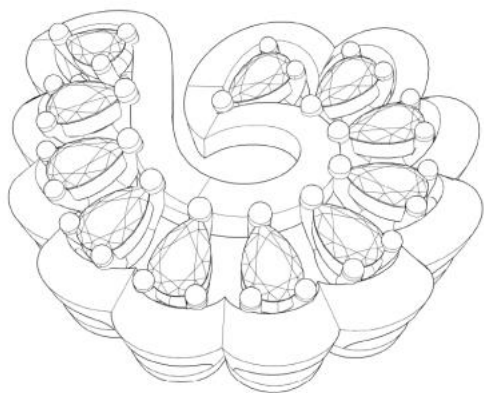

---

[11] 2016566.2

[15] 27-07-2020

[51] Cl. 21-01

[54] 玩具

Toy

[73] Dragon Rainbow Limited

Level 2, 1 Lam Wah Street,

Kowloon Bay, Kowloon,

Hong Kong

[74] CHINAHONGKONG IP LIMITED

3011, 30/F, Office Tower, Convention Plaza,

1 Harbour Road,

Hong Kong

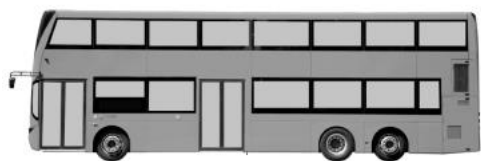

---

[11] 2016567.4

[15] 27-07-2020

[51] Cl. 12-08

[54] 巴士  
Bus

[73] Dragon Rainbow Limited  
Level 2, 1 Lam Wah Street,  
Kowloon Bay, Kowloon,  
Hong Kong

[74] CHINAHONGKONG IP LIMITED  
3011, 30/F, Office Tower, Convention Plaza,  
1 Harbour Road,  
Hong Kong

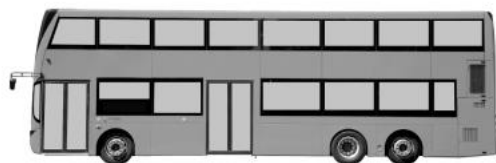

---

[11] 2016568.6

[15] 27-07-2020

[30] 27-01-2020 / US / 29/722,197

[51] Cl. 14-01

[54] 耳塞式耳機  
Earbud headset

[73] Skullcandy, Inc.  
6301 N. Landmark Dr. Park City, UT 84098  
United States

[74] CLT PATENT & TRADEMARK (H.K.) LIMITED  
Unit 09, 34/F., Office Tower, Convention Plaza,  
No. 1 Harbour Road,  
Wanchai, Hong Kong

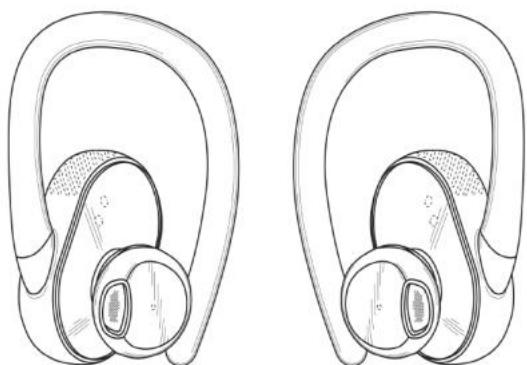

---

[11] 2016569.8M001

[15] 27-07-2020

[30] 26-03-2020 / CN / 202030108355.9

[51] Cl. 14-02

[54] 人臉識別一體機

Face recognition machine

[73] 深圳市商湯科技有限公司

SHENZHEN SENSETIME TECHNOLOGY CO., LTD.

中國內地

深圳市前海深港合作區前灣一路1號

A棟201室

[74] 香港派特恩知識產權代理有限公司

香港上環

永樂街121-125號

永達商業大廈10樓C室

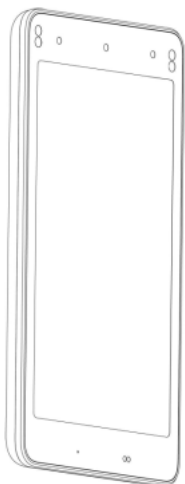

[11] 2016569.8M002

[15] 27-07-2020

[30] 26-03-2020 / CN / 202030108355.9

[51] C1. 14-02

[54] 人臉識別一體機

Face recognition machine

[73] 深圳市商湯科技有限公司

SHENZHEN SENSETIME TECHNOLOGY CO., LTD.

中國內地

深圳市前海深港合作區前灣一路1號

A棟201室

[74] 香港派特恩知識產權代理有限公司

香港上環

永樂街121-125號

永達商業大廈10樓C室





香港特別行政區政府知識產權署外觀設計註冊處

The Government of the Hong Kong Special Administrative Region

Designs Registry, Intellectual Property Department

根據註冊外觀設計條例第 28 條，下列註冊外觀設計因未繳續期費而停止有效。

各組記項按註冊外觀設計停止有效日期及註冊編號先後次序排列。

**Registered designs ceased through non-payment of renewal fees under section 28 of the Registered Designs Ordinance. Entries are listed below under their expiry dates.**

**26-08-2020 - 02-09-2020**

<b>26-08-2020</b>	1001570.1M002	1501930.0M002
1001556.2M001	1001571.3	
1001556.2M002	1501900.7	<b>01-09-2020</b>
1501885.4M001	1501901.9	0502035.1
1501885.4M002	1501902.1	0502042.5
1501885.4M003	1501903.3	1001584.0M001
1501886.6M001	1501904.5	1001584.0M002
1501886.6M002	1501905.8	1001586.5
	1501906.0M001	1001587.7
<b>27-08-2020</b>	1501906.0M002	1501931.2
1501888.0	1501906.0M003	1501933.6
1501889.2M001	1501907.2M001	1501934.8
1501889.2M003	1501907.2M005	1501936.3M001
1501890.4	1501907.2M006	1501936.3M002
1501895.5	1501908.4	1501937.5M001
1501896.7		1501937.5M002
	<b>31-08-2020</b>	1501938.7M001
<b>28-08-2020</b>	0011184.1M001	1501938.7M002
0011165.2	0011184.1M003	1501942.5
0011167.6	0011184.1M004	1501943.7
	0011184.1M006	1501944.9
<b>29-08-2020</b>	0011188.0	1501945.2
1001558.6M001	0011189.2M001	1501946.4
1001558.6M002	0011189.2M002	1501947.6
1001560.0	1001569.9M001	1501948.8
1001561.2	1001569.9M002	1501949.0
1001563.6M001	1001569.9M003	1501950.2
1001563.6M002	1001569.9M004	1501952.6
1001564.8M001	1001576.4	
1001564.8M002	1001579.0	<b>02-09-2020</b>
1001565.1	1001581.4	1001590.3M002
	1501919.7	1001597.8
<b>30-08-2020</b>	1501924.7	1001598.0
1001570.1M001	1501929.8	1001599.2

1001601.8

1001603.2





香港特別行政區政府知識產權署外觀設計註冊處

The Government of the Hong Kong Special Administrative Region

Designs Registry, Intellectual Property Department

### 根據註冊外觀設計條例第 30 條放棄的外觀設計的註冊

### **Surrender of registration of design under section 30 of the Registered Designs Ordinance**

[11] 1801925.3

[73] Yell Group Limited



香港特別行政區政府知識產權署外觀設計註冊處

The Government of the Hong Kong Special Administrative Region

Designs Registry, Intellectual Property Department

根據註冊外觀設計規則第 31 條刪除的註冊外觀設計。各組記項按註冊外觀設計刪除日期及註冊編號先後次序排列。

**Registered designs removed under section 31 of the Registered Designs Rules. Entries are listed below under their removal dates.**

**15-10-2020 - 22-10-2020**

<b>15-10-2020</b>	0500417.9M001
1500520.0	0500417.9M002
1500522.4M001	0500417.9M003
1500522.4M002	0500417.9M004
1500522.4M004	0500417.9M005
1500522.4M005	0500417.9M006
1500522.4M006	0500417.9M007
1500522.4M007	0500422.9
1500522.4M008	1000381.8
1500522.4M009	1000385.7M002
1500533.7	1500561.6M001
1500534.9	1500561.6M002

**18-10-2020**

0500399.9	1500561.6M003
1000333.7	1500561.6M004
	1500561.6M005
	1500561.6M006
	1500562.8

**21-10-2020**

0500402.7M001	1500563.0
0500404.1	1500564.2
0500406.6	1500567.9
0500408.0	
1500535.2	
1500543.8M001	
1500543.8M002	
1500544.0M002	
1500544.0M003	
1500544.0M004	
1500544.0M005	
1500544.0M006	
1500550.3	
1500552.7	

**22-10-2020**



香港特別行政區政府知識產權署外觀設計註冊處

The Government of the Hong Kong Special Administrative Region

Designs Registry, Intellectual Property Department

## 根據註冊外觀設計條例第 67 及 76 條，更正註冊紀錄冊內及已提交文件中的錯誤

### Correction of Errors in Register and in Filed Documents under sections 67 and 76 of the Registered Designs Ordinance

任何人士現可對下列更正錯誤的請求提出反對

Requests for correction of errors now open to opposition

如任何人士意欲反對下列請求，則須在本官方公報刊登是項更正請求的日期起計的兩個月內，根據註冊外觀設計規則第51(3)及62(4)條，採用指明外觀設計表格第D9號提交反對通知。如在限期內沒有收到任何反對通知，處長將依本公報刊登的更正請求的內容，准許是項更正請求。

If any person wishes to oppose the following requests, he shall file a notice of opposition in specified Designs Form D9 within two months from the date of advertisement in this official journal under sections 51(3) and 62(4) of the Registered Designs Rules. If no notice of opposition is received, the requests for correction will be allowed by the Registrar in the present advertised form.

請求更正外觀設計的表述的錯誤

Request made for correction of the representations of the design

[11] 2015722.2M001

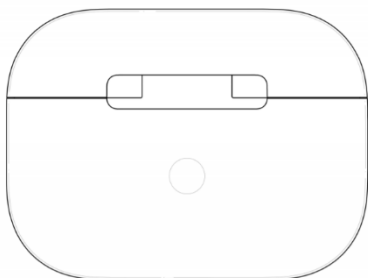

Rear view thereof



香港特別行政區政府知識產權署外觀設計註冊處

The Government of the Hong Kong Special Administrative Region

Designs Registry, Intellectual Property Department

## 根據註冊外觀設計條例第 76 條，更正已提交文件中的錯誤

### **Correction of errors in filed documents under section 76 of the Registered Designs Ordinance**

任何人士現可對下列更正錯誤的請求提出反對

Requests for correction of errors now open to opposition

如任何人士意欲反對下列請求，則須在本官方公報公告更正請求的日期起兩個月內，根據註冊外觀設計規則第 62(4) 條，採用指明外觀設計表格第 D9 號提交反對通知。如在限期內沒有收到任何反對通知，處長將依本公報公告更正請求的內容，准許更正請求。

If any person wishes to oppose the following request, he shall file a notice of opposition to the request in specified Designs Form D9 within two months from the date of advertisement in this official journal under section 62(4) of the Registered Designs Rules. If no notice of opposition is received, the request for correction will be allowed by the Registrar in the present advertised form.

[21] 1914318.1M001-M004

[54] 皮膚按摩器 Skin massager