

香港知識產權公報

Hong Kong Intellectual Property Journal

2019 年 11 月 8 日

8 November 2019

目錄

Contents

根據註冊外觀設計條例第 25 條註冊的外觀設計

Designs Registered under section 25 of the Registered Designs Ordinance

按註冊編號排列

Arranged by Registration Number

根據註冊外觀設計條例(第 522 章)公布的其他公告

Other Notices Published under the Registered Designs Ordinance (Cap. 522)

根據註冊外觀設計條例第 28 條，註冊外觀設計因未繳續期費而停止有效

Registered designs ceased through non-payment of renewal fees under section 28 of the Registered Designs Ordinance

根據註冊外觀設計規則第 31 條刪除的註冊外觀設計

Registered designs removed under section 31 of the Registered Designs Rules

根據註冊外觀設計條例第 67 及 76 條，更正註冊紀錄冊內及已提交文件中的錯誤

Correction of Errors in Register and in Filed Documents under sections 67 and 76 of the Registered Designs Ordinance

以下事項沒有記錄

No Records for the Following Matters

根據註冊外觀設計條例第 30 條放棄的外觀設計的註冊

Surrender of Registration of Design under section 30 of the Registered Designs Ordinance

根據註冊外觀設計規則第 37 條，向處長作出轉介

Reference to Registrar under section 37 of the Registered Designs Rules

根據註冊外觀設計條例第 45 條, 撤銷註冊

Revocation of Registration under section 45 of the Registered Designs Ordinance

根據註冊外觀設計規則第 46 條, 向法院作出轉介

Reference to Court under section 46 of the Registered Designs Rules

根據註冊外觀設計規則第 63 條對不符合規定之處作出糾正

Rectification of Irregularities under section 63 of the Registered Designs Rules

根據註冊外觀設計條例第 66 條, 糾正註冊紀錄冊

Rectification of Register under section 66 of the Registered Designs Ordinance

根據註冊外觀設計條例第 67 條, 更正註冊紀錄冊內的錯誤

Correction of Errors in Register under section 67 of the Registered Designs Ordinance

根據註冊外觀設計條例第 76 條, 更正已提交文件中的錯誤

Correction of Errors in Filed Documents under section 76 of the Registered Designs Ordinance

勘誤

Corrigendum

註冊外觀設計公告註釋

Notes on advertisements of registration of designs

方括號表示下列資料：

Square brackets indicate the following data：

- [11] 註冊編號 Registration number / 聯合王國註冊編號 United Kingdom registration number

- [15] 註冊日期 Registration date / 當作註冊日期 Deemed registration date / 聯合王國註冊日期 United Kingdom registration date

- [17] 註冊有效期屆滿日期 Expiry date of the period of registration

- [22] 提交日期 Filing date / 當作提交日期 Deemed filing date / 聯合王國提交日期 United Kingdom filing date

- [30] 聲稱享有的優先權 (提交日期 / 巴黎公約國或世界貿易組織成員 / 申請編號) Priority claimed (filing date / Paris Convention country or WTO member / application number)

- [51] 國際外觀設計分類號 (洛迦諾分類號) International Classification of designs (Locarno Classification)

- [54] 物品 Article

- [55] 外觀設計的表述 Representation of the design

- [62] 分開前的申請編號及提交日期 Application number before division and filing date

- [66] 過往註冊的聯繫外觀設計註冊編號 / 日期 Registration No. / Date of Previous Registration for Association

- [72] 設計人 Designer

[73] 擁有人姓名和地址 Name and address of the owner

[74] 代理人 Agent / 送達地址 Address for service



香港特別行政區政府知識產權署外觀設計註冊處

The Government of the Hong Kong Special Administrative Region

Designs Registry, Intellectual Property Department

根據註冊外觀設計條例第 25 條註冊的外觀設計

Designs registered under section 25 of the Registered Designs Ordinance

按註冊編號排列

Arranged by Registration Number

- [11] 1802488.5M001
- [15] 19-12-2018
- [30] 12-07-2018 / EM / 005501624-0001
- [51] Cl. 6-02
- [54] 嬰兒床
Crib
- [73] Artsana S.p.A.
Via Saldarini Catelli 1,
22070 Grandate CO,
ITALY
- [74] C&H IP LAW LIMITED
1206, Eastern Commercial Centre,
397 Hennessy Road, Wan Chai,
Hong Kong.



-
- [11] 1802488.5M002
 - [15] 19-12-2018
 - [30] 12-07-2018 / EM / 005501624-0002
 - [51] Cl. 6-02
 - [54] 嬰兒床
Crib

[73] Artsana S.p.A.
Via Saldarini Catelli 1,
22070 Grandate CO,
ITALY

[74] C&H IP LAW LIMITED
1206, Eastern Commercial Centre,
397 Hennessy Road, Wan Chai,
Hong Kong.

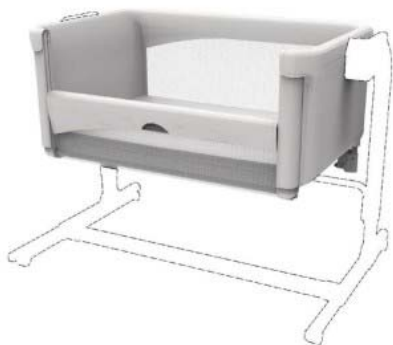

[11] 1802488.5M003

[15] 19-12-2018

[30] 12-07-2018 / EM / 005501624-0003

[51] Cl. 6-02

[54] 嬰兒床

Crib

[73] Artsana S.p.A.
Via Saldarini Catelli 1,
22070 Grandate CO,
ITALY

[74] C&H IP LAW LIMITED
1206, Eastern Commercial Centre,
397 Hennessy Road, Wan Chai,
Hong Kong.



- [11] 1802488.5M004
[15] 19-12-2018
[30] 12-07-2018 / EM / 005501624-0004
[51] Cl. 6-02
[54] 嬰兒床
Crib
[73] Artsana S.p.A.
Via Saldarini Catelli 1,
22070 Grandate CO,
ITALY
[74] C&H IP LAW LIMITED
1206, Eastern Commercial Centre,
397 Hennessy Road, Wan Chai,
Hong Kong.



-
- [11] 1802488.5M005
[15] 19-12-2018
[30] 12-07-2018 / EM / 005501624-0005
[51] Cl. 6-02
[54] 嬰兒床
Crib
[73] Artsana S.p.A.
Via Saldarini Catelli 1,
22070 Grandate CO,
ITALY
[74] C&H IP LAW LIMITED
1206, Eastern Commercial Centre,
397 Hennessy Road, Wan Chai,
Hong Kong.

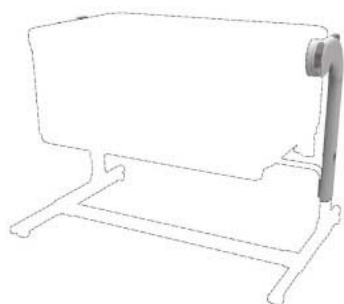

[11] 1900088.6

[15] 14-01-2019

[51] Cl. 11-01

[54] 戒指

Ring

[73] SURANA BROTHERS IP HOLDINGS LIMITED

Unit 2, 11/F., Tower B,

Hung Hom Commercial Centre,

37 Ma Tau Wai Road, Hunghom, Kowloon, Hong Kong

[74] CHAN, TANG & KWOK

Rooms 2503-04, 25/F.,

Shanghai Industrial Investment Building,

48-62 Hennessy Road, Wanchai, Hong Kong.

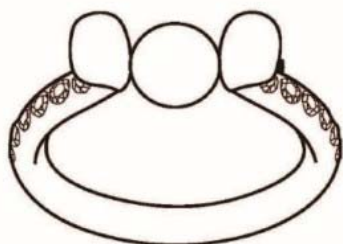

[11] 1900109.2M001

[15] 18-01-2019

[30] 25-07-2018 / CN / 201830402427.3

[51] Cl. 14-02

[54] 可捲曲鍵盤

Rollable keyboard

[73] 深圳市柔宇科技有限公司 中
國內地廣東省深圳市龍崗區
橫崗街道龍崗大道 8288 號
大運軟件小鎮 43 棟

[74] 香港金誠智慧顧問有限公司
香港上環
干諾道西 28 號
威勝商業大廈 5 樓 501-503 室

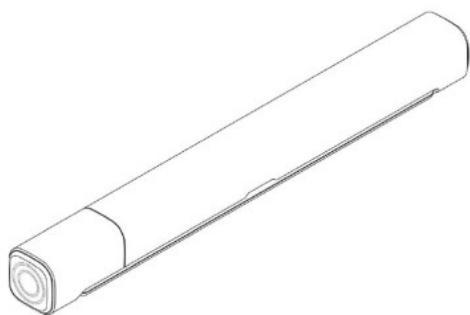

[11] 1900109.2M002

[15] 18-01-2019

[30] 25-07-2018 / CN / 201830402427.3

[51] Cl. 14-02

[54] 可捲曲鍵盤

Rollable keyboard

[73] 深圳市柔宇科技有限公司
中國內地廣東省深圳市龍崗區
橫崗街道龍崗大道 8288 號
大運軟件小鎮 43 棟

[74] 香港金誠智慧顧問有限公司
香港上環
干諾道西 28 號
威勝商業大廈 5 樓 501-503 室

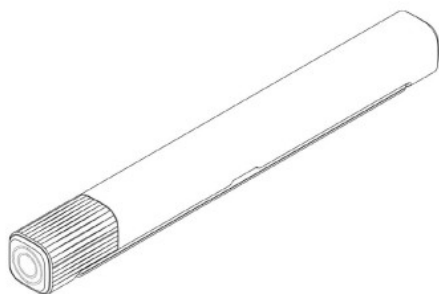

[11] 1900184.9

[15] 28-01-2019

[51] Cl. 7-02

[54] 氣體爐頭

Gas burner

[73] 陳獻楨

Hsien-Chen CHEN

18F.-2, No. 21, Ln. 35, Sec. 2, Sanmin Rd.,
Banqiao Dist., New Taipei City,
TAIWAN

[74] WENPING & CO.

1701 Tung Wai Commercial Building,
111 Gloucester Road,
Hong Kong.

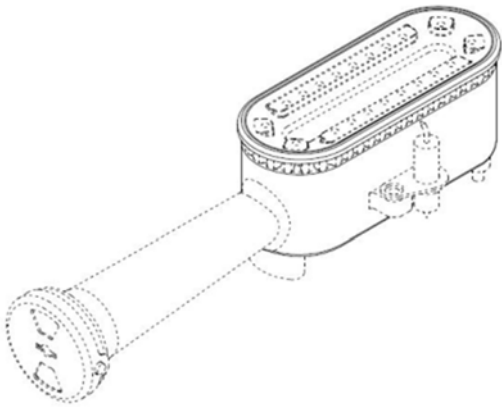

[11] 1900210.6M001

[15] 31-01-2019

[30] 31-07-2018 / US / 29/658,466

[51] Cl. 20-02

[54] 零售展示固定裝置組

Retail display fixture group

[73] 蘋果公司

APPLE INC.

ONE APPLE PARK WAY, CUPERTINO,
CALIFORNIA 95014, U.S.A.

UNITED STATES

[74] CLT Patent & Trademark (H.K.) Ltd.

Unit 09, 34/F., Office Tower,
Convention Plaza, No. 1 Harbour Road,
Wanchai, Hong Kong.

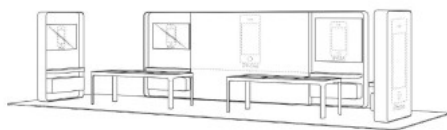

[11] 1900210.6M002

[15] 31-01-2019

[30] 31-07-2018 / US / 29/658,466

[51] Cl. 20-02

[54] 零售展示固定裝置組

Retail display fixture group

[73] 蘋果公司

APPLE INC.

ONE APPLE PARK WAY, CUPERTINO,
CALIFORNIA 95014, U.S.A.

UNITED STATES

[74] CLT Patent & Trademark (H.K.) Ltd.

Unit 09, 34/F., Office Tower,
Convention Plaza, No. 1 Harbour Road,
Wanchai, Hong Kong.

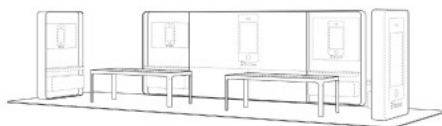

[11] 1900210.6M003

[15] 31-01-2019

[30] 31-07-2018 / US / 29/658,466

[51] Cl. 20-02

[54] 零售展示固定裝置組

Retail display fixture group

[73] 蘋果公司

APPLE INC.

ONE APPLE PARK WAY, CUPERTINO,
CALIFORNIA 95014, U.S.A.

UNITED STATES

[74] CLT Patent & Trademark (H.K.) Ltd.

Unit 09, 34/F., Office Tower,
Convention Plaza, No. 1 Harbour Road,
Wanchai, Hong Kong.

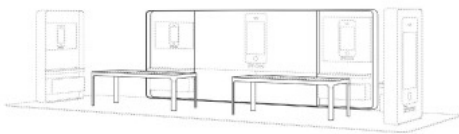

[11] 1900210.6M004

[15] 31-01-2019

[30] 31-07-2018 / US / 29/658,466

[51] Cl. 20-02

[54] 零售展示固定裝置組

Retail display fixture group

[73] 蘋果公司

APPLE INC.

ONE APPLE PARK WAY, CUPERTINO,

CALIFORNIA 95014, U.S.A.

UNITED STATES

[74] CLT Patent & Trademark (H.K.) Ltd.

Unit 09, 34/F., Office Tower,

Convention Plaza, No. 1 Harbour Road,

Wanchai, Hong Kong.

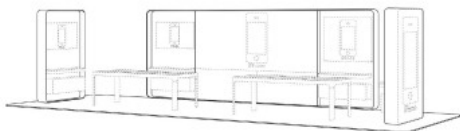

[11] 1900210.6M005

[15] 31-01-2019

[30] 31-07-2018 / US / 29/658,466

[51] Cl. 20-02

[54] 零售展示固定裝置組

Retail display fixture group

[73] 蘋果公司

APPLE INC.

ONE APPLE PARK WAY, CUPERTINO,

CALIFORNIA 95014, U.S.A.

UNITED STATES

[74] CLT Patent & Trademark (H.K.) Ltd.

Unit 09, 34/F., Office Tower,

Convention Plaza, No. 1 Harbour Road,
Wanchai, Hong Kong.

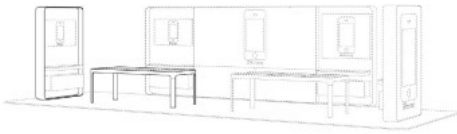

[11] 1900210.6M006

[15] 31-01-2019

[30] 31-07-2018 / US / 29/658,466

[51] Cl. 20-02

[54] 零售展示固定裝置組

Retail display fixture group

[73] 蘋果公司

APPLE INC.

ONE APPLE PARK WAY, CUPERTINO,
CALIFORNIA 95014, U.S.A.

UNITED STATES

[74] CLT Patent & Trademark (H.K.) Ltd.

Unit 09, 34/F., Office Tower,
Convention Plaza, No. 1 Harbour Road,
Wanchai, Hong Kong.



[11] 1900210.6M007

[15] 31-01-2019

[30] 31-07-2018 / US / 29/658,466

[51] Cl. 20-02

[54] 零售展示固定裝置組

Retail display fixture group

[73] 蘋果公司

APPLE INC.

ONE APPLE PARK WAY, CUPERTINO,
CALIFORNIA 95014, U.S.A.

UNITED STATES

- [74] CLT Patent & Trademark (H.K.) Ltd.
Unit 09, 34/F., Office Tower,
Convention Plaza, No. 1 Harbour Road,
Wanchai, Hong Kong.

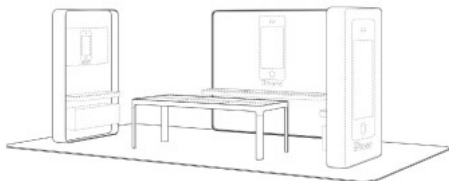

-
- [11] 1900210.6M008
[15] 31-01-2019
[30] 31-07-2018 / US / 29/658,466
[51] Cl. 20-02
[54] 零售展示固定裝置組
Retail display fixture group
[73] 蘋果公司
APPLE INC.
ONE APPLE PARK WAY, CUPERTINO,
CALIFORNIA 95014, U.S.A.
UNITED STATES
[74] CLT Patent & Trademark (H.K.) Ltd.
Unit 09, 34/F., Office Tower,
Convention Plaza, No. 1 Harbour Road,
Wanchai, Hong Kong.

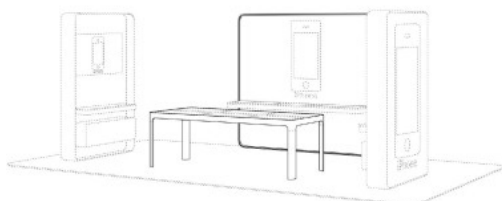

-
- [11] 1900210.6M009
[15] 31-01-2019
[30] 31-07-2018 / US / 29/658,466
[51] Cl. 20-02
[54] 零售展示固定裝置組
Retail display fixture group
[73] 蘋果公司
APPLE INC.
ONE APPLE PARK WAY, CUPERTINO,

CALIFORNIA 95014, U.S.A.

UNITED STATES

- [74] CLT Patent & Trademark (H.K.) Ltd.
Unit 09, 34/F., Office Tower,
Convention Plaza, No. 1 Harbour Road,
Wanchai, Hong Kong.

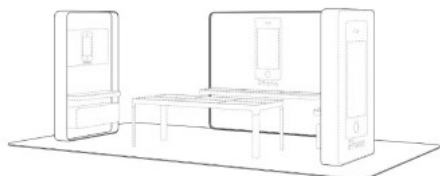

[11] 1900210.6M010

[15] 31-01-2019

[30] 31-07-2018 / US / 29/658,466

[51] Cl. 20-02

[54] 零售展示固定裝置組

Retail display fixture group

[73] 蘋果公司

APPLE INC.

ONE APPLE PARK WAY, CUPERTINO,

CALIFORNIA 95014, U.S.A.

UNITED STATES

- [74] CLT Patent & Trademark (H.K.) Ltd.
Unit 09, 34/F., Office Tower,
Convention Plaza, No. 1 Harbour Road,
Wanchai, Hong Kong.



[11] 1900213.2M001

[15] 31-01-2019

[30] 28-09-2018 / CN / 201830549094.7

[51] Cl. 12-11

[54] 電動車

Electric scooter

[73] GOVECS AG

Grillparzerstraße 18,
81675 Munich,
Germany

[74] CLYDE & CO

58/F, Central Plaza,
18 Harbour Road,
Wanchai, Hong Kong



[11] 1900213.2M002

[15] 31-01-2019

[30] 28-09-2018 / CN / 201830549740.X

[51] Cl. 12-16

[54] 電動車車架

Frame of an electric scooter

[73] GOVECS AG

Grillparzerstraße 18,
81675 Munich,
Germany

[74] CLYDE & CO

58/F, Central Plaza,
18 Harbour Road,
Wanchai, Hong Kong



[11] 1913040.0M001

[15] 15-02-2019

[51] Cl. 9-01

[54] 化粧品用樽

Bottle for cosmetics

[73] Kabushikigaisha Shiseido (SHISEIDO Co., Ltd.)

5-5, Ginza 7-chome, Chuo-ku

Tokyo

JAPAN

[74] MARKS & CLERK

Level 9, Cyberport 1

100 Cyberport Road, Pok Fu Lam

HONG KONG

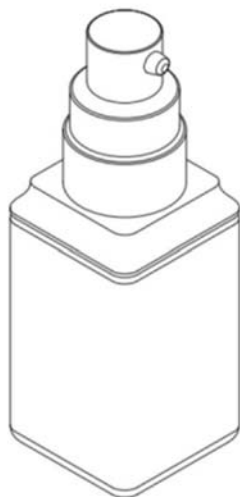

[11] 1913040.0M002

[15] 15-02-2019

[51] Cl. 9-01

[54] 化粧品用樽

Bottle for cosmetics

[73] Kabushikigaisha Shiseido (SHISEIDO Co., Ltd.)

5-5, Ginza 7-chome, Chuo-ku

Tokyo

JAPAN

[74] MARKS & CLERK

Level 9, Cyberport 1

100 Cyberport Road, Pok Fu Lam

HONG KONG

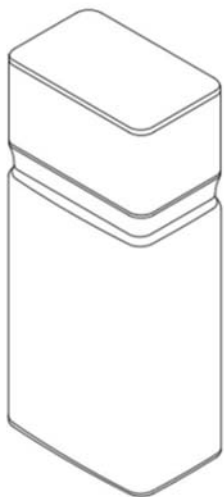

[11] 1913040.0M003

[15] 15-02-2019

[51] Cl. 9-01

[54] 包裝用管子

Tube for packing

[73] Kabushikigaisha Shiseido (SHISEIDO Co., Ltd.)

5-5, Ginza 7-chome, Chuo-ku

Tokyo

JAPAN

[74] MARKS & CLERK

Level 9, Cyberport 1

100 Cyberport Road, Pok Fu Lam

HONG KONG



[11] 1913067.7

[15] 21-02-2019

[51] Cl. 23-04

[54] 風扇的螺旋槳

Propeller of fan

[73] Mitsubishi Electric Corporation

7-3, Marunouchi 2-chome, Chiyoda-ku, Tokyo 100-8310

JAPAN

[74] LIU, SHEN & ASSOCIATES

Room 3716, 37/F, Sun Hung Kai Centre,

30 Harbour Road, Wanchai,

HONG KONG

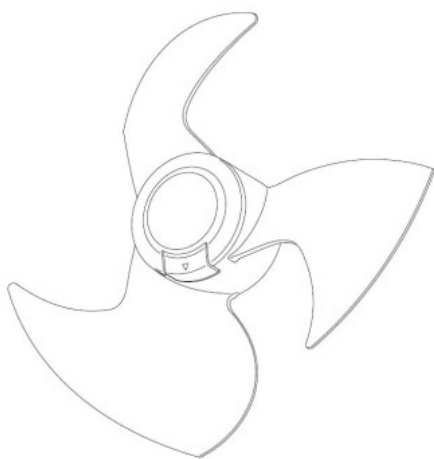

[11] 1913084.2

[15] 25-02-2019

[30] 24-08-2018 / JP / 2018 of 018493

[51] Cl. 28-03

[54] 美顏器

Facial treatment device

[73] 力仕株式会社

LUXMAN KABUSHIKI KAISHA(LUXMAN CORPORATION)

日本 神奈川県横

浜市

港北區新横浜 1 丁目 3 番地 1 號

[74] 中港知識產權有限公司

香港

港灣道 1 號

會展廣場辦公大樓 30 樓 3011 室

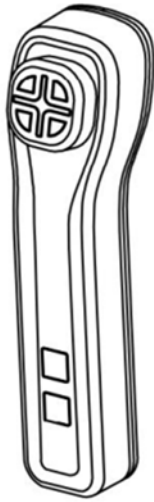

[11] 1913092.9

[15] 26-02-2019

[51] Cl. 14-03

[54] 調頻收音機連藍牙音箱外殼

FM radio with bluetooth speaker housing

[73] SHENZHEN AIRSMART TECHNOLOGY CO., LTD

616

Ant's Union Start-up Accelerator,

No.9 KeJi Road, Science and Technology Park,

Nanshan District Shenzhen, Guangdong

CHINA

[74] HK STANDARD INTELLECTUAL PROPERTY LIMITED

21/F CMA BUILDING, NO. 64 CONNAUGHT ROAD CENTRAL

HONG KONG

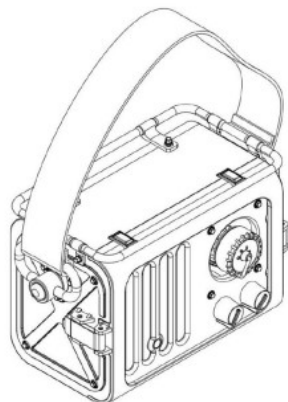

[11] 1913093.1

[15] 26-02-2019

[51] Cl. 14-03

[54] 調頻收音機連藍牙音箱外殼

FM radio with bluetooth speaker housing

[73] SHENZHEN AIRSMART TECHNOLOGY CO., LTD

616,

Ant's Union Start-up Accelerator,

No.9 KeJi Road, Science and Technology Park,

Nanshan District Shenzhen, Guangdong

CHINA

[74] HK STANDARD INTELLECTUAL PROPERTY LIMITED

21/F, CMA BUILDING, NO. 64 CONNAUGHT ROAD CENTRAL,

HONG KONG



[11] 1913095.6

[15] 26-02-2019

[51] Cl. 28-03

[54] 用於自動注射裝置的針頭部件
Needle unit for automatic injecting device

[73] BOMTECH ELECTRONICS Co., Ltd.
322, Gonghang-daero
Gangseo-gu, Seoul
KOREA, REPUBLIC OF

[74] BENNY KONG & TSAI
Unit 19B, Overseas Trust Bank Building
No. 160 Gloucester Road, Wanchai
HONG KONG

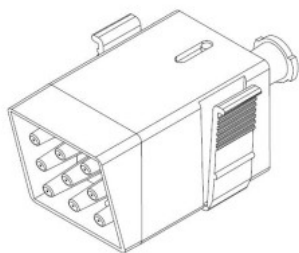

[11] 1913096.8

[15] 26-02-2019

[51] Cl. 25-99

[54] 馬路防滑板
Road anti-skid plate

[73] 黎廣昌
香港
新界大埔
泰亨祠堂村 103 地下

[74] 江炳滔律師事務所
香港
灣仔告士打道 160 號 海外信託銀行
大廈 19 樓 B 室



- [11] 1913101.0
[15] 27-02-2019
[51] Cl. 11-04
[54] 獨角馬花藝品
Floral Art of Unicorn
[73] PINK FABLE LIMITED
Unit 1118, 11th Floor, Tower B, Southmark, 11 Yip Hing Street,
Wong Chuk Hang, Hong Kong.
[74] VINCENT LUK & ASSOCIATES
Unit A, 13th Floor, Nathan Commercial Building,
430 Nathan Road, Kowloon, Hong Kong.



-
- [11] 1913105.9
[15] 28-02-2019
[51] Cl. 14-01
[54] 耳機
Earphone
[73] 創品科技有限公司
Inno3C Limited
香港九龍 觀塘鴻
圖道 41 號
華鴻工貿中心 8 樓 1 室
[74] 創品科技有限公司
香港九龍 觀塘鴻
圖道 41 號
華鴻工貿中心 8 樓 1 室
HONG KONG.



[11] 1913294.7M001

[15] 25-03-2019

[30] 28-09-2018 / EU, JP, KR, CH, GB / WIPO75912

[51] Cl. 11-01

[54] 戒指
Ring

[73] Cartier International AG
Hinterbergstrasse 22
6312 STEINHAUSEN
SWITZERLAND

[74] DEACONS
5th Floor, Alexandra House
Central
HONG KONG

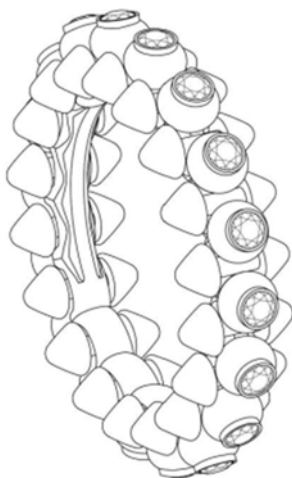

[11] 1913294.7M002

[15] 25-03-2019

[30] 28-09-2018 / EU, JP, KR, CH, GB / WIPO75912

[51] Cl. 11-01

[54] 戒指
Ring

[73] Cartier International AG
Hinterbergstrasse 22
6312 STEINHAUSEN
SWITZERLAND

[74] DEACONS
5th Floor, Alexandra House
Central
HONG KONG

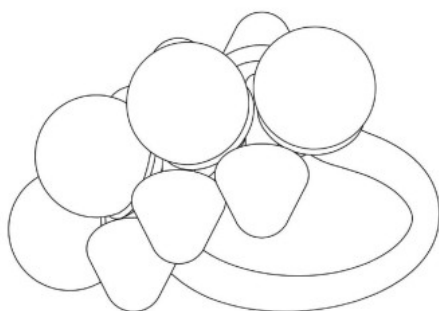

[11] 1913294.7M003

[15] 25-03-2019

[30] 28-09-2018 / EU, JP, KR, CH, GB / WIPO75912

[51] Cl. 11-01

[54] 戒指
Ring

[73] Cartier International AG
Hinterbergstrasse 22
6312 STEINHAUSEN
SWITZERLAND

[74] DEACONS
5th Floor, Alexandra House
Central
HONG KONG



[11] 1913294.7M004

[15] 25-03-2019

[30] 28-09-2018 / EU, JP, KR, CH, GB / WIPO75912

[51] Cl. 11-01

[54] 手鐲

Bracelet

[73] Cartier International AG

Hinterbergstrasse 22

6312 STEINHAUSEN

SWITZERLAND

[74] DEACONS

5th Floor, Alexandra House

Central

HONG KONG



[11] 1913294.7M005

[15] 25-03-2019

[30] 28-09-2018 / EU, JP, KR, CH, GB / WIPO75912

[51] Cl. 11-01

[54] 手鐲

Bracelet

[73] Cartier International AG
Hinterbergstrasse 22
6312 STEINHAUSEN
SWITZERLAND

[74] DEACONS
5th Floor, Alexandra House
Central
HONG KONG

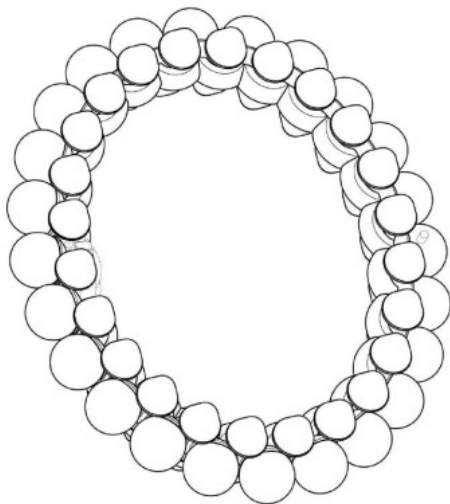

[11] 1913294.7M006

[15] 25-03-2019

[30] 28-09-2018 / EU, JP, KR, CH, GB / WIPO75912

[51] Cl. 11-01

[54] 手鐲
Bracelet

[73] Cartier International AG
Hinterbergstrasse 22
6312 STEINHAUSEN
SWITZERLAND

[74] DEACONS
5th Floor, Alexandra House
Central
HONG KONG



[11] 1913294.7M007

[15] 25-03-2019

[30] 28-09-2018 / EU, JP, KR, CH, GB / WIPO75912

[51] Cl. 11-01

[54] 項鍊

Necklace

[73] Cartier International AG

Hinterbergstrasse 22

6312 STEINHAUSEN

SWITZERLAND

[74] DEACONS

5th Floor, Alexandra House

Central

HONG KONG



[11] 1913294.7M008

[15] 25-03-2019

[30] 28-09-2018 / EU, JP, KR, CH, GB / WIPO75912

[51] Cl. 11-01

[54] 項鍊

Necklace

[73] Cartier International AG

Hinterbergstrasse 22

6312 STEINHAUSEN

SWITZERLAND

[74] DEACONS

5th Floor, Alexandra House

Central

HONG KONG



[11] 1913294.7M009

[15] 25-03-2019

[30] 28-09-2018 / EU, JP, KR, CH, GB / WIPO75912

[51] Cl. 11-01

[54] 耳環

Earrings

[73] Cartier International AG

Hinterbergstrasse 22

6312 STEINHAUSEN

SWITZERLAND

[74] DEACONS

5th Floor, Alexandra House

Central

HONG KONG

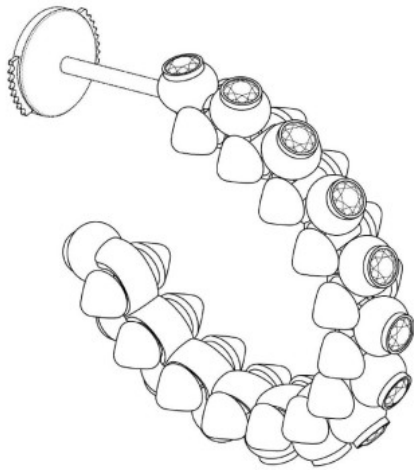

[11] 1913294.7M010

[15] 25-03-2019

[30] 28-09-2018 / EU, JP, KR, CH, GB / WIPO75912

[51] Cl. 11-01

[54] 耳環

Earrings

[73] Cartier International AG

Hinterbergstrasse 22

6312 STEINHAUSEN

SWITZERLAND

[74] DEACONS

5th Floor, Alexandra House

Central

HONG KONG

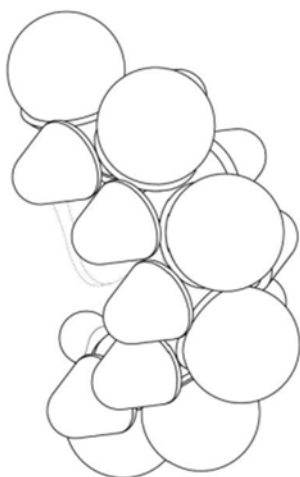

[11] 1913294.7M011

[15] 25-03-2019

[30] 28-09-2018 / EU, JP, KR, CH, GB / WIPO75912

[51] Cl. 11-01

[54] 耳環
Earrings

[73] Cartier International AG
Hinterbergstrasse 22
6312 STEINHAUSEN
SWITZERLAND

[74] DEACONS
5th Floor, Alexandra House
Central
HONG KONG



[11] 1913294.7M012

[15] 25-03-2019

[30] 28-09-2018 / EU, JP, KR, CH, GB / WIPO75912

[51] Cl. 11-01

[54] 裝飾零件
Decorative elements

[73] Cartier International AG
Hinterbergstrasse 22
6312 STEINHAUSEN
SWITZERLAND

[74] DEACONS
5th Floor, Alexandra House
Central
HONG KONG

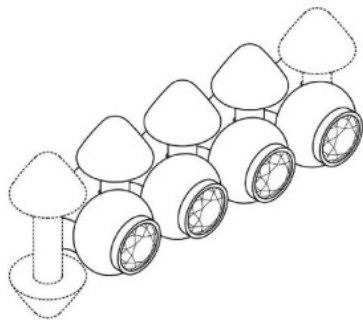

[11] 1913294.7M013

[15] 25-03-2019

[30] 28-09-2018 / EU, JP, KR, CH, GB / WIPO75912

[51] Cl. 11-01

[54] 裝飾零件

Decorative elements

[73] Cartier International AG

Hinterbergstrasse 22

6312 STEINHAUSEN

SWITZERLAND

[74] DEACONS

5th Floor, Alexandra House

Central

HONG KONG

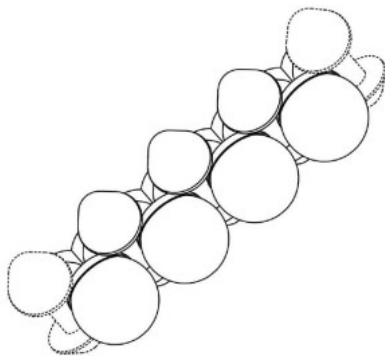

[11] 1913294.7M014

[15] 25-03-2019

[30] 28-09-2018 / EU, JP, KR, CH, GB / WIPO75912

[51] Cl. 11-01

[54] 裝飾零件

Decorative elements

[73] Cartier International AG
Hinterbergstrasse 22
6312 STEINHAUSEN
SWITZERLAND

[74] DEACONS
5th Floor, Alexandra House
Central
HONG KONG

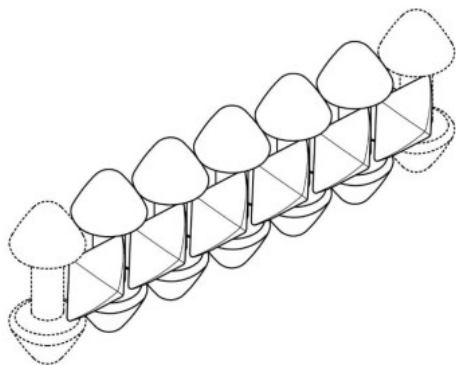

[11] 1913401.6

[15] 08-04-2019

[30] 10-10-2018 / US / 29/666,121

[51] Cl. 7-01

[54] 餐盒

Lunch box

[73] William Huckestein
5963 Olivas Park Drive, Suite F
Ventura CA 93003
UNITED STATES

Scott Kim

5963 Olivas Park Drive, Suite F
Ventura CA 93003
UNITED STATES

[74] IVAN WONG IP LIMITED
Unit 1406, 14th Floor, The Broadway,
54-62 Lockhart Road, Wanchai,
HONG KONG

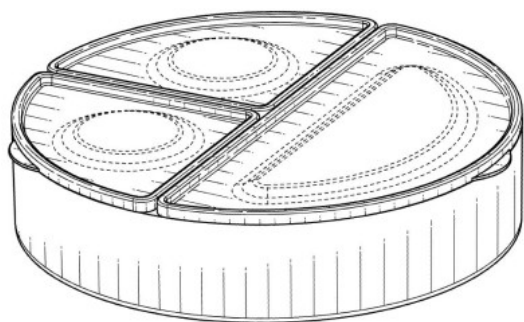

[11] 1913504.5

[15] 24-04-2019

[51] Cl. 19-06

[54] 滑動熒光筆

Sliding highlighter

[73] INTERMED ASIA LIMITED

5/F., BLOCK B, ELDEX IND BLDG., 21 MA TAU WAI ROAD
HUNG HOM, KOWLOON, HONG KONG

[74] CHINA PATENT AGENT (HONG KONG) LIMITED

22/F, Great Eagle Centre, 23 Harbour Road, Wanchai,
HONG KONG

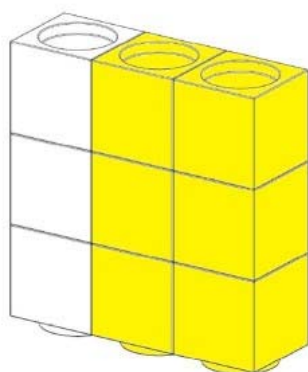

[11] 1913749.4M001

[15] 28-05-2019

[30] 30-11-2018 / JP / 2018 of 026062

[51] Cl. 2-04

[54] 襪

Sock

[73] OKAMOTO Corporation

150-1 Oaza Otsuka

Koryo-cho
Kitakatsuragi-gun
Nara, 635-8550
JAPAN

[74] DEACONS
5th Floor, Alexandra House
Central
HONG KONG

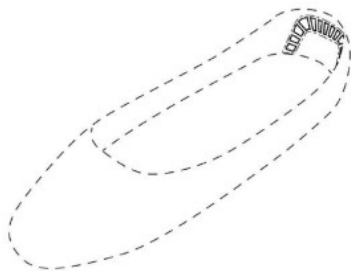

[11] 1913749.4M002

[15] 28-05-2019

[30] 30-11-2018 / JP / 2018 of 026063

[51] Cl. 2-04

[54] 襪

Sock

[73] OKAMOTO Corporation

150-1 Oaza Otsuka

Koryo-cho

Kitakatsuragi-gun

Nara, 635-8550

JAPAN

[74] DEACONS

5th Floor, Alexandra House

Central

HONG KONG

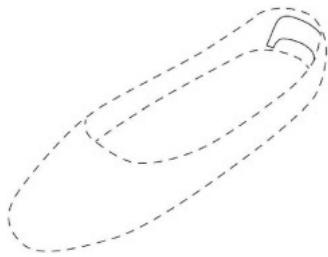

[11] 1913749.4M003

[15] 28-05-2019

[30] 30-11-2018 / JP / 2018 of 026064

[51] Cl. 2-04

[54] 襪

Sock

[73] OKAMOTO Corporation

150-1 Oaza Otsuka

Koryo-cho

Kitakatsuragi-gun

Nara, 635-8550

JAPAN

[74] DEACONS

5th Floor, Alexandra House

Central

HONG KONG



[11] 1913749.4M004

[15] 28-05-2019

[30] 30-11-2018 / JP / 2018 of 026065

[51] Cl. 2-04

[54] 襪

Sock

[73] OKAMOTO Corporation

150-1 Oaza Otsuka

Koryo-cho

Kitakatsuragi-gun

Nara, 635-8550

JAPAN

[74] DEACONS

5th Floor, Alexandra House

Central

HONG KONG

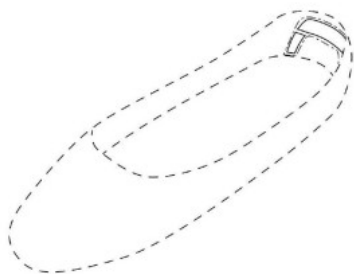

[11] 1913749.4M005

[15] 28-05-2019

[30] 30-11-2018 / JP / 2018 of 026066

[51] Cl. 2-04

[54] 襪

Sock

[73] OKAMOTO Corporation

150-1 Oaza Otsuka

Koryo-cho

Kitakatsuragi-gun

Nara, 635-8550

JAPAN

[74] DEACONS

5th Floor, Alexandra House

Central

HONG KONG

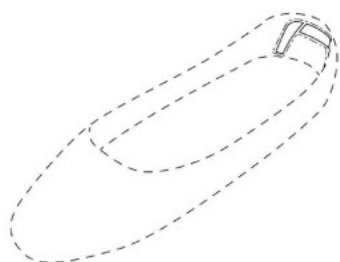

[11] 1913749.4M006

[15] 28-05-2019

[30] 30-11-2018 / JP / 2018 of 026069

[51] Cl. 2-04

[54] 襪

Sock

[73] OKAMOTO Corporation

150-1 Oaza Otsuka

Koryo-cho

Kitakatsuragi-gun

Nara, 635-8550

JAPAN

[74] DEACONS

5th Floor, Alexandra House

Central

HONG KONG

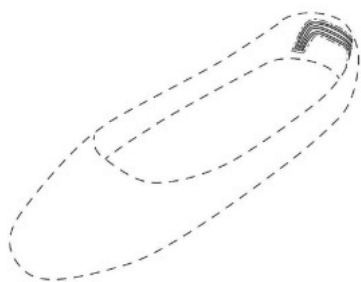

[11] 1913749.4M007

[15] 28-05-2019

[30] 30-11-2018 / JP / 2018 of 026070

[51] Cl. 2-04

[54] 襪

Sock

[73] OKAMOTO Corporation
150-1 Oaza Otsuka
Koryo-cho
Kitakatsuragi-gun
Nara, 635-8550
JAPAN

[74] DEACONS
5th Floor, Alexandra House
Central
HONG KONG

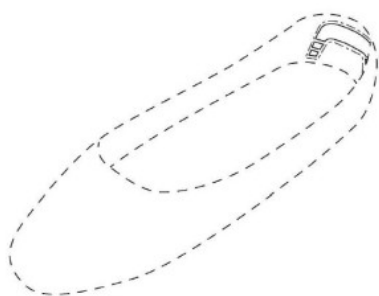

[11] 1913766.0M001

[15] 29-05-2019

[30] 14-12-2018 / EU, AZ, MC, AL, AM, BZ, GE, BA, LI, MN, ME, MA,
NO, OM, MD, SG, CH, TN, UA, GB, TR, KG, MK / DM/200 543

[51] Cl. 10-07

[54] 錶面
DIAL

[73] MONTRES JAQUET DROZ SA (MONTRES JAQUET DROZ AG) (MONTRES
JAQUET DROZ LTD.)
Allée du Tourbillon 2, CH-2300 La Chaux-de-Fonds,
SWITZERLAND

[74] SPRUSON & FERGUSON (HONG KONG) LIMITED
5001 Hopewell Centre
183 Queen's Road East, Wan Chai
HONG KONG



[11] 1913766.0M002

[15] 29-05-2019

[30] 14-12-2018 / EU, AZ, MC, AL, AM, BZ, GE, BA, LI, MN, ME, MA,
NO, OM, MD, SG, CH, TN, UA, GB, TR, KG, MK / DM/200 543

[51] Cl. 10-07

[54] 錶面
DIAL

[73] MONTRES JAQUET DROZ SA (MONTRES JAQUET DROZ AG) (MONTRES
JAQUET DROZ LTD.)
Allée du Tourbillon 2, CH-2300 La Chaux-de-Fonds,
SWITZERLAND

[74] SPRUSON & FERGUSON (HONG KONG) LIMITED
5001 Hopewell Centre
183 Queen's Road East, Wan Chai
HONG KONG



[11] 1913766.0M003

[15] 29-05-2019

[30] 14-12-2018 / EU, AZ, MC, AL, AM, BZ, GE, BA, LI, MN, ME, MA,
NO, OM, MD, SG, CH, TN, UA, GB, TR, KG, MK / DM/200 543

[51] Cl. 10-07

[54] 錶面
DIAL

[73] MONTRES JAQUET DROZ SA (MONTRES JAQUET DROZ AG) (MONTRES
JAQUET DROZ LTD.)
Allée du Tourbillon 2, CH-2300 La Chaux-de-Fonds,
SWITZERLAND

[74] SPRUSON & FERGUSON (HONG KONG) LIMITED
5001 Hopewell Centre
183 Queen's Road East, Wan Chai
HONG KONG

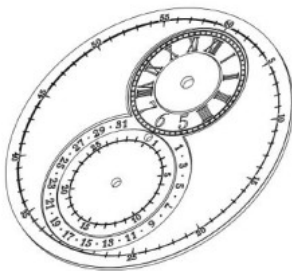

[11] 1913766.0M004

[15] 29-05-2019

[30] 14-12-2018 / EU, AZ, MC, AL, AM, BZ, GE, BA, LI, MN, ME, MA,
NO, OM, MD, SG, CH, TN, UA, GB, TR, KG, MK / DM/200 543

[51] Cl. 10-07

[54] 自動盤
OSCILLATING WEIGHT

[73] MONTRES JAQUET DROZ SA (MONTRES JAQUET DROZ AG) (MONTRES
JAQUET DROZ LTD.)
Allée du Tourbillon 2, CH-2300 La Chaux-de-Fonds,
SWITZERLAND

[74] SPRUSON & FERGUSON (HONG KONG) LIMITED
5001 Hopewell Centre
183 Queen's Road East, Wan Chai
HONG KONG

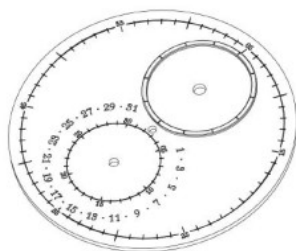

[11] 1913768.4M001

[15] 29-05-2019

[30] 21-12-2018 / EU, AZ, MC, AL, AU, BZ, GE, BA, LI, MN, ME, MA,
NO, OM, MD, SG, CH, TN, UA, GB, TR, KG, MK / DM/200 135

[51] Cl. 10-07

[54] 錶面
DIAL

[73] MONTRES JAQUET DROZ SA (MONTRES JAQUET DROZ AG) (MONTRES
JAQUET DROZ LTD.)
Allée du Tourbillon 2, CH-2300 La Chaux-de-Fonds,
SWITZERLAND

[74] SPRUSON & FERGUSON (HONG KONG) LIMITED
5001 Hopewell Centre
183 Queen's Road East, Wan Chai
HONG KONG

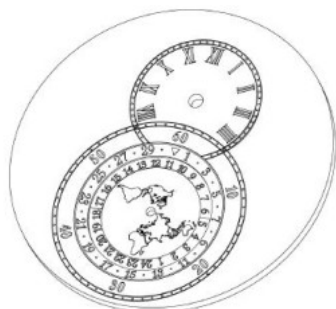

[11] 1913768.4M002

[15] 29-05-2019

- [30] 21-12-2018 / EU, AZ, MC, AL, AU, BZ, GE, BA, LI, MN, ME, MA, NO, OM, MD, SG, CH, TN, UA, GB, TR, KG, MK / DM/200 135
- [51] Cl. 10-07
- [54] 錶面
DIAL
- [73] MONTRES JAQUET DROZ SA (MONTRES JAQUET DROZ AG) (MONTRES JAQUET DROZ LTD.)
Allée du Tourbillon 2, CH-2300 La Chaux-de-Fonds,
SWITZERLAND
- [74] SPRUSON & FERGUSON (HONG KONG) LIMITED
5001 Hopewell Centre
183 Queen's Road East, Wan Chai
HONG KONG



-
- [11] 1913769.6
- [15] 29-05-2019
- [30] 18-02-2019 / EU, BO, AZ, MC, AL, AM, BZ, GE, LI, MN, ME, MA, NO, OM, MD, SG, CH, TN, UA, GB, TR, KG, MK / DM/201 013
- [51] Cl. 10-02
- [54] 錶
Watch
- [73] RADO UHREN AG (RADO WATCH CO. LTD.) (MONTRES RADO SA)
Bielstrasse 45, CH-2543 Lengnau,
SWITZERLAND
- [74] SPRUSON & FERGUSON (HONG KONG) LIMITED
5001 Hopewell Centre
183 Queen's Road East, Wan Chai
HONG KONG



[11] 1913772.2

[15] 29-05-2019

[51] Cl. 25-02

[54] 道路圍欄

Road barrier

[73] WORLD TECH HONG KONG GROUP LIMITED

FLAT 706, 7/F, KAR WAH INDUSTRIAL BUILDING,

LEUNG YIP STREET, YUEN LONG, NEW TERRITORIES, HONG KONG

HONG KONG

[74] IPMS CONSULTANTS LIMITED

UNIT 2004B, 20/F, TOWER 5, CHINA HONG KONG CITY,

33 CANTON ROAD, TSIM SHA TSUI, KOWLOON,

HONG KONG

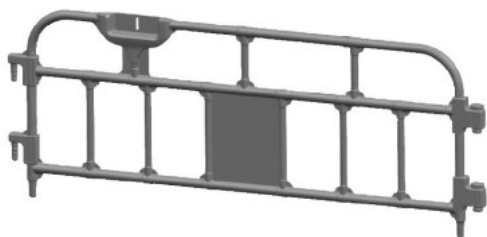

[11] 1913775.9M001

[15] 30-05-2019

[51] Cl. 3-01

[54] 行李箱

LUGGAGE

[73] 新秀麗 IP 控股有限責任公司

Samsonite IP Holdings S.à r.l.

13-15 avenue de la Liberté,

L-1931 Luxembourg,
LUXEMBOURG

[74] WILKINSON & GRIST
6th Floor, Prince's Building
Chater Road
HONG KONG

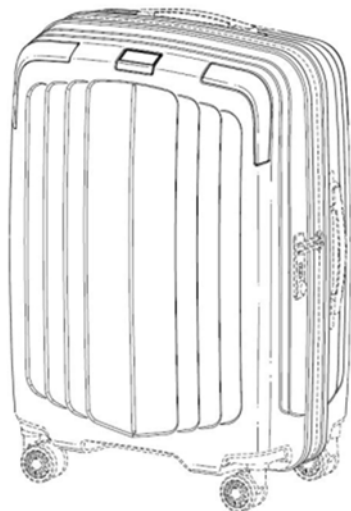

[11] 1913775.9M002

[15] 30-05-2019

[51] Cl. 3-01

[54] 行李箱

LUGGAGE

[73] 新秀麗 IP 控股有限責任公司
Samsonite IP Holdings S.à r.l.
13-15 avenue de la Liberté,
L-1931 Luxembourg,
LUXEMBOURG

[74] WILKINSON & GRIST
6th Floor, Prince's Building
Chater Road
HONG KONG

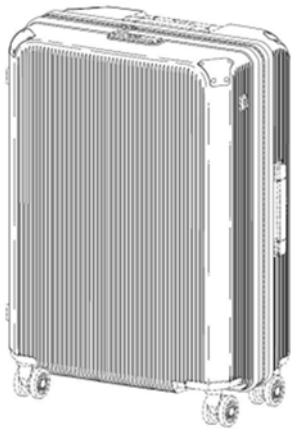

[11] 1913775.9M003

[15] 30-05-2019

[51] Cl. 3-01

[54] 行李箱

LUGGAGE

[73] 新秀麗 IP 控股有限責任公司

Samsonite IP Holdings S.à r.l.

13-15 avenue de la Liberté,

L-1931 Luxembourg,

LUXEMBOURG

[74] WILKINSON & GRIST

6th Floor, Prince's Building

Chater Road

HONG KONG

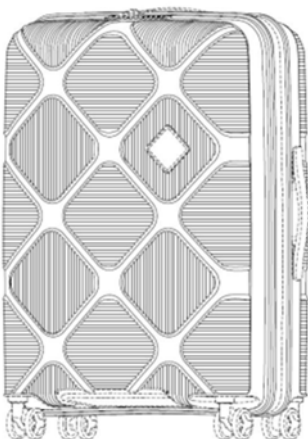

[11] 1913775.9M004

[15] 30-05-2019

[51] Cl. 3-01

[54] 行李箱

LUGGAGE

[73] 新秀麗 IP 控股有限責任公司

Samsonite IP Holdings S.à r.l.

13-15 avenue de la Liberté,

L-1931 Luxembourg,

LUXEMBOURG

[74] WILKINSON & GRIST

6th Floor, Prince's Building

Chater Road

HONG KONG



[11] 1913775.9M005

[15] 30-05-2019

[51] Cl. 3-01

[54] 行李箱

LUGGAGE

[73] 新秀麗 IP 控股有限責任公司

Samsonite IP Holdings S.à r.l.

13-15 avenue de la Liberté,

L-1931 Luxembourg,

LUXEMBOURG

[74] WILKINSON & GRIST

6th Floor, Prince's Building

Chater Road

HONG KONG

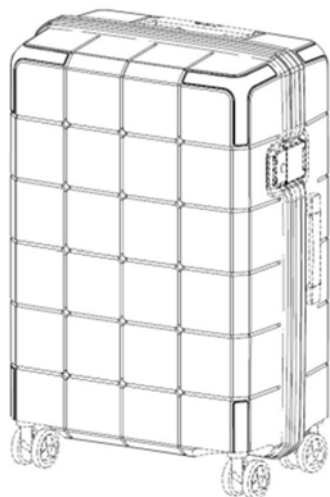

[11] 1913775.9M006

[15] 30-05-2019

[51] Cl. 3-01

[54] 行李箱

LUGGAGE

[73] 新秀麗 IP 控股有限責任公司

Samsonite IP Holdings S.à r.l.

13-15 avenue de la Liberté,

L-1931 Luxembourg,

LUXEMBOURG

[74] WILKINSON & GRIST

6th Floor, Prince's Building

Chater Road

HONG KONG

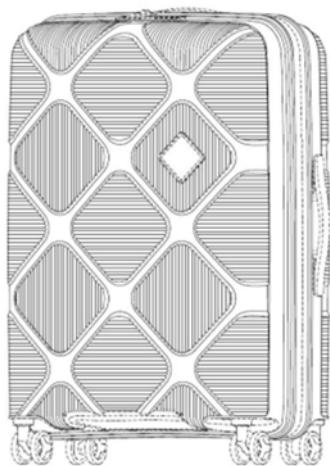

[11] 1913775.9M007

[15] 30-05-2019

[51] Cl. 3-01

[54] 行李箱

LUGGAGE

[73] 新秀麗 IP 控股有限責任公司

Samsonite IP Holdings S.à r.l.

13-15 avenue de la Liberté,

L-1931 Luxembourg,

LUXEMBOURG

[74] WILKINSON & GRIST

6th Floor, Prince's Building

Chater Road

HONG KONG



[11] 1913775.9M008

[15] 30-05-2019

[51] Cl. 3-01

[54] 行李箱

LUGGAGE

[73] 新秀麗 IP 控股有限責任公司

Samsonite IP Holdings S.à r.l.

13-15 avenue de la Liberté,

L-1931 Luxembourg,

LUXEMBOURG

[74] WILKINSON & GRIST

6th Floor, Prince's Building

Chater Road

HONG KONG

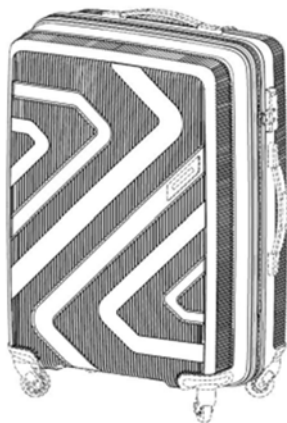

[11] 1913776.1M001

[15] 30-05-2019

[30] 29-12-2018 / CN / 201830771047.7

[51] Cl. 26-05

[54] 夜燈

Night light

[73] ZhongShan Winstar Electrical Co., Ltd.

SanDun Industry District,

MinZhong Town, Zhongshan, Guangdong

CHINA

[74] FEDERATION OF HONG KONG INDUSTRIES

31/F, Billion Plaza,

8 Cheung Yue Street, Cheung Sha Wan, Kowloon

HONG KONG

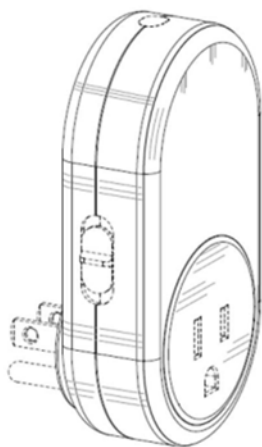

- [11] 1913776.1M002
[15] 30-05-2019
[30] 29-12-2018 / CN / 201830772808.0
[51] Cl. 26-05
[54] 夜燈
Night light
[73] ZhongShan Winstar Electrical Co., Ltd.
SanDun Industry District,
MinZhong Town, Zhongshan, Guangdong
CHINA
[74] FEDERATION OF HONG KONG INDUSTRIES
31/F, Billion Plaza,
8 Cheung Yue Street, Cheung Sha Wan, Kowloon
HONG KONG

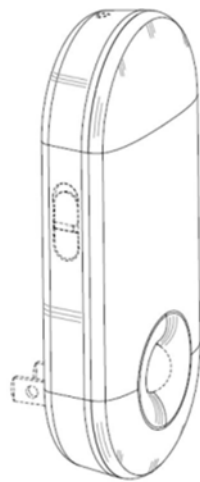

-
- [11] 1913776.1M003
[15] 30-05-2019
[30] 11-01-2019 / CN / 201930015018.2
[51] Cl. 26-05
[54] 夜燈
Night light
[73] ZhongShan Winstar Electrical Co., Ltd.
SanDun Industry District,
MinZhong Town, Zhongshan, Guangdong
CHINA
[74] FEDERATION OF HONG KONG INDUSTRIES
31/F, Billion Plaza,
8 Cheung Yue Street, Cheung Sha Wan, Kowloon
HONG KONG

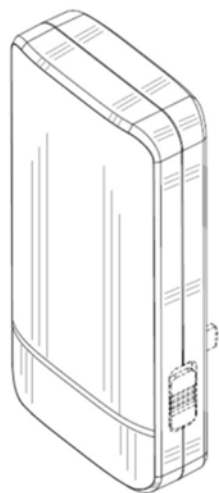

[11] 1913776.1M004

[15] 30-05-2019

[51] Cl. 26-05

[54] 夜燈

Night light

[73] ZhongShan Winstar Electrical Co., Ltd.

SanDun Industry District,

MinZhong Town, Zhongshan, Guangdong

CHINA

[74] FEDERATION OF HONG KONG INDUSTRIES

31/F, Billion Plaza,

8 Cheung Yue Street, Cheung Sha Wan, Kowloon

HONG KONG



[11] 1913777.3

[15] 30-05-2019

[30] 06-12-2018 / IT / 402018000003367

[51] Cl. 3-01

[54] 袋

Bag

[73] VALENTINO S.p.A.

Via Turati, 16/18

I-20121 MILANO

ITALY

[74] BARRON & YOUNG INTELLECTUAL PROPERTY LIMITED

Suite 617, Lakeside 2

No. 10 Science Park West Avenue, Hong Kong Science Park,

Shatin, N.T.

HONG KONG

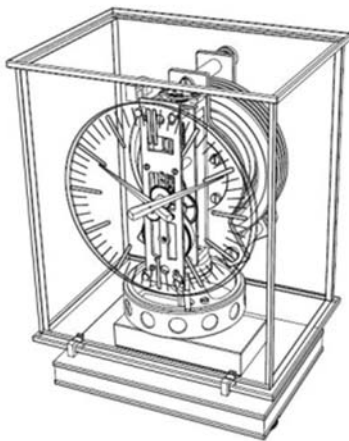

[11] 1913782.3M001

[15] 30-05-2019

[51] Cl. 23-04

[54] 香薰機

Aroma diffuser

[73] Bloomy Lotus Ltd

Unit 4711, 47/F., The Center,

99 Queen's Road Central, Central

HONG KONG

[74] FEDERATION OF HONG KONG INDUSTRIES

31/F, Billion Plaza,

8 Cheung Yue Street, Cheung Sha Wan, Kowloon

HONG KONG



[11] 1913782.3M002

[15] 30-05-2019

[51] Cl. 23-04

[54] 香薰機

Aroma diffuser

[73] Bloomy Lotus Ltd

Unit 4711, 47/F., The Center,
99 Queen's Road Central, Central
HONG KONG

[74] FEDERATION OF HONG KONG INDUSTRIES

31/F, Billion Plaza,
8 Cheung Yue Street, Cheung Sha Wan, Kowloon
HONG KONG



[11] 1913782.3M003

[15] 30-05-2019

[51] Cl. 23-04

[54] 香薰機

Aroma diffuser

[73] Bloomy Lotus Ltd

Unit 4711, 47/F., The Center,
99 Queen's Road Central, Central
HONG KONG

[74] FEDERATION OF HONG KONG INDUSTRIES

31/F, Billion Plaza,
8 Cheung Yue Street, Cheung Sha Wan, Kowloon
HONG KONG

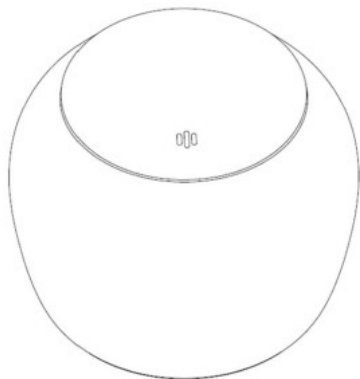

[11] 1913782.3M004

[15] 30-05-2019

[51] Cl. 23-04

[54] 香薰機

Aroma diffuser

[73] Bloomy Lotus Ltd

Unit 4711, 47/F., The Center,
99 Queen's Road Central, Central
HONG KONG

[74] FEDERATION OF HONG KONG INDUSTRIES

31/F, Billion Plaza,
8 Cheung Yue Street, Cheung Sha Wan, Kowloon
HONG KONG

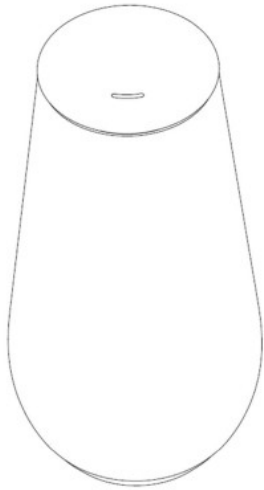

[11] 1913782.3M005

[15] 30-05-2019

[51] Cl. 23-04

[54] 香薰機

Aroma diffuser

[73] Bloomy Lotus Ltd

Unit 4711, 47/F., The Center,

99 Queen's Road Central, Central

HONG KONG

[74] FEDERATION OF HONG KONG INDUSTRIES

31/F, Billion Plaza,

8 Cheung Yue Street, Cheung Sha Wan, Kowloon

HONG KONG



[11] 1913798.7

[15] 31-05-2019

[30] 15-05-2019 / CN / 201930238710.1

[51] Cl. 23-04

[54] 香薰機

Aroma diffuser

[73] 璞真生活有限公司

PUZHEN LIFE CO., LTD.

Unit 1112-1116, 11/F, Delta House,

3 On Yiu Street, Shatin

HONG KONG

[74] 伍永強

Room 1002, 10/F,

88 Hing Fat Street, Causeway Bay, Hong Kong



[11] 1913799.9

[15] 31-05-2019

[30] 15-05-2019 / CN / 201930238711.6

[51] Cl. 23-04

[54] 香薰機

Aroma diffuser

[73] 璞真生活有限公司

PUZHEN LIFE CO., LTD.

Unit 1112-1116, 11/F, Delta House,

3 On Yiu Street, Shatin

HONG KONG

[74] 伍永強

Room 1002, 10/F,

88 Hing Fat Street, Causeway Bay, Hong Kong



[11] 1913800.3

[15] 31-05-2019

[30] 12-02-2019 / JP / 2019 of 002806

[51] Cl. 28-03

[54] 自發熱用具

Self-warming Tool

[73] 花王株式會社

Kao Kabushiki Kaisha (Kao Corporation)

14-10, Nihonbashi Kayabacho 1-chome, Chuo-ku, Tokyo

JAPAN

[74] CHINAHONGKONG PATENT LIMITED

3012, 30/F, Office Tower, Convention Plaza, 1 Harbour Road

HONG KONG

HONG KONG

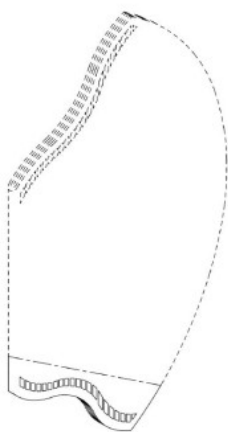

[11] 1913801.5

[15] 31-05-2019

[30] 17-12-2018 / CN / 201830731908.9

[51] Cl. 14-01

[54] 耳機

Earphone

[73] 索尼公司

SONY CORPORATION

1-7-1 KONAN, MINATO-KU

TOKYO 108-0075, JAPAN

JAPAN

[74] UNITALEN ATTORNEYS AT LAW LIMITED

RM 1201, 12/F, GOLDEN ERA PLAZA,

39-55 SAI YEE ST, MONGKOK KLN,

HONG KONG

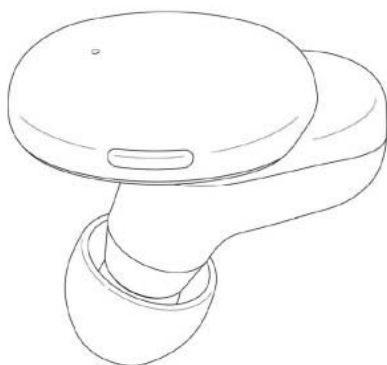

[11] 1913802.7M001

[15] 31-05-2019

[30] 05-12-2018 / EU, MC, KR, SG, CH, TR / WIPO77865

[51] Cl. 2-04

[54] 拖鞋

Slipper

[73] BOTTEGA VENETA S.R.L.

Località Conti Maltraverso 1,

36054 Montebello Vicentino (VI),

ITALY

[74] REBECCA LO & CO

1408 Dina House, Ruttonjee Centre

11 Duddell Street, Central

3104 8787

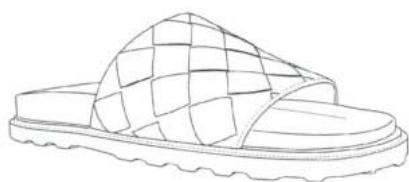

[11] 1913802.7M002

[15] 31-05-2019

[30] 05-12-2018 / EU, MC, KR, SG, CH, TR / WIPO77865

[51] Cl. 2-04

[54] 鞋
Shoe

[73] BOTTEGA VENETA S.R.L.
Località Conti Maltraverso 1,
36054 Montebello Vicentino (VI),
ITALY

[74] REBECCA LO & CO
1408 Dina House, Ruttonjee Centre
11 Duddell Street, Central
3104 8787

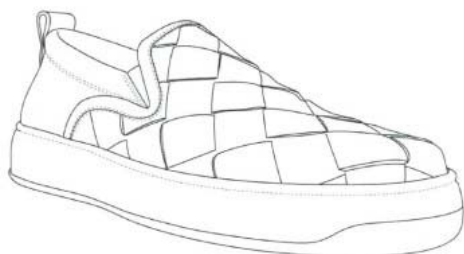

[11] 1913804.1

[15] 03-06-2019

[30] 26-12-2018 / JP / 028426 of 2018

[51] Cl. 9-03

[54] 包裝用容器
Container for packaging

[73] UTENA CO., LTD.
株式會社佑天蘭
10-22, MINAMI-KARASUYAMA 1-CHOME, SETAGAYA-KU, TOKYO 157-8567

- [74] 中國專利代理(香港)有限公司
香港
灣仔
港灣道 23 號鷹君中心 22 字樓

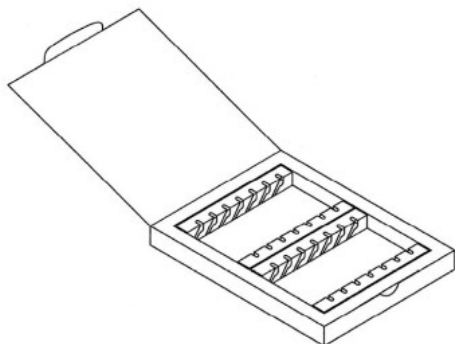

-
- [11] 1913806.6
[15] 03-06-2019
[30] 24-01-2019 / CN / 201930040300.6
[51] Cl. 26-02
[54] 手持式發光二極管照明設備
Handheld LED lighting equipment
[73] AEC Lighting Solutions Co., Ltd
上海智匯電器有限公司 中國內地上海
市 嘉定區馬陸鎮寶安公路 2548 號
郵編 201801
[74] 中港專利有限公司
香港
港灣道 1 號
會展廣場辦公大樓 30 樓 3012 室
HONG KONG



-
- [11] 1913807.8
[15] 03-06-2019
[30] 20-12-2018 / CN / 201830754373.7
[51] Cl. 26-02
[54] 超薄防水發光二極管直板燈
Ultra-thin waterproof LED flat lamp
[73] AEC Lighting Solutions Co., Ltd
上海智匯電器有限公司 中國內地上海
市 嘉定區馬陸鎮寶安公路 2548 號
郵編 201801
[74] 中港專利有限公司
香港
港灣道 1 號
會展廣場辦公大樓 30 樓 3012 室
HONG KONG



- [11] 1913808.0
[15] 03-06-2019
[30] 20-12-2018 / CN / 201830741393.0
[51] Cl. 26-02
[54] 鋁製手持式發光二極管燈
Aluminum handheld LED lamp
[73] AEC Lighting Solutions Co., Ltd
上海智匯電器有限公司 中國內地上海
市 嘉定區馬陸鎮寶安公路 2548 號
郵編 201801
[74] 中港專利有限公司
香港
港灣道 1 號
會展廣場辦公大樓 30 樓 3012 室
HONG KONG



-
- [11] 1913809.2M001
[15] 03-06-2019
[51] Cl. 10-07
[54] 錶外框
Watch bezel
[73] Nove Limited
Flat A, C & D, 3/F, Phase I, Kingsway Industrial Building, 167
- 175 Wo Yi Hop Road, Kwai Chung, New Territories, HONG KONG
[74] ALAN & ASSOCIATES (HONG KONG) INTELLECTUAL PROPERTY AGENCY LTD
Unit A, 25/F, United Centre,
No. 95 Queensway,
HONG KONG

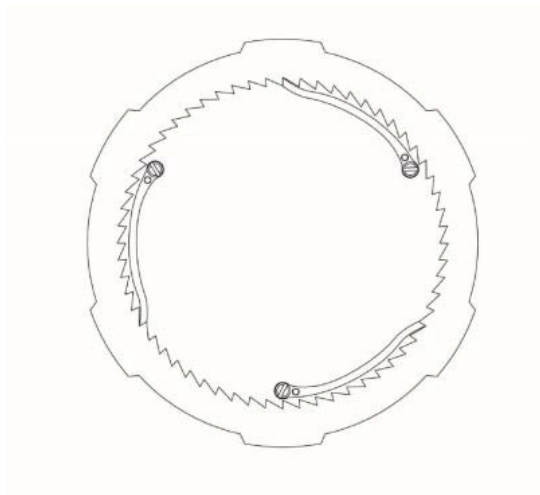

[11] 1913809.2M002

[15] 03-06-2019

[51] Cl. 10-07

[54] 錶面

Watch dial

[73] Nove Limited

Flat A, C & D, 3/F, Phase I, Kingsway Industrial Building, 167
- 175 Wo Yi Hop Road, Kwai Chung, New Territories, HONG KONG

[74] ALAN & ASSOCIATES (HONG KONG) INTELLECTUAL PROPERTY AGENCY LTD

Unit A, 25/F, United Centre,
No. 95 Queensway,
HONG KONG

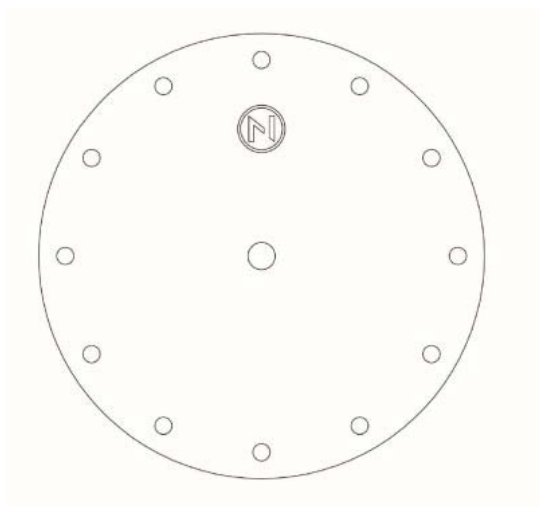

[11] 1913813.0M001

[15] 03-06-2019

[30] 19-12-2018 / US / 29/674,023

[51] Cl. 2-04

[54] 鞋子底部

Footwear sole

[73] TBL Licensing LLC

200 Domain Drive, Stratham,

New Hampshire 03885, US, UNITED STATES

[74] FEDERATION OF HONG KONG INDUSTRIES

31/F, Billion Plaza,

8 Cheung Yue Street, Cheung Sha Wan, Kowloon, HONG KONG



[11] 1913813.0M002

[15] 03-06-2019

[30] 19-12-2018 / US / 29/674,023

[51] Cl. 2-04

[54] 鞋子底部

Footwear sole

[73] TBL Licensing LLC

200 Domain Drive, Stratham,

New Hampshire 03885, US, UNITED STATES

[74] FEDERATION OF HONG KONG INDUSTRIES

31/F, Billion Plaza,

8 Cheung Yue Street, Cheung Sha Wan, Kowloon, HONG KONG

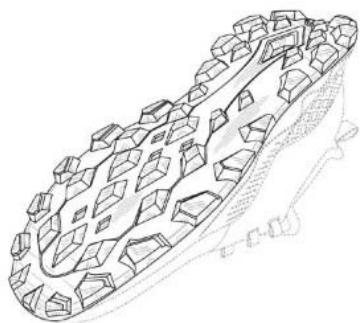

[11] 1913813.0M003

[15] 03-06-2019

[30] 19-12-2018 / US / 29/674,023

[51] Cl. 2-04

[54] 鞋子底部

Footwear sole

[73] TBL Licensing LLC

200 Domain Drive, Stratham,

New Hampshire 03885, US, UNITED STATES

[74] FEDERATION OF HONG KONG INDUSTRIES

31/F, Billion Plaza,

8 Cheung Yue Street, Cheung Sha Wan, Kowloon, HONG KONG

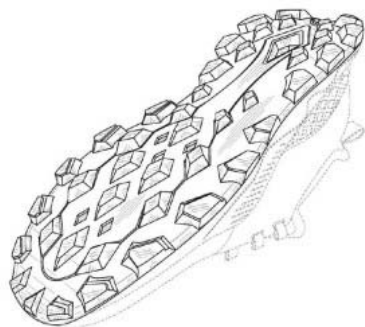

[11] 1913813.0M004

[15] 03-06-2019

[30] 19-12-2018 / US / 29/674,023

[51] Cl. 2-04

[54] 鞋子底部

Footwear sole

[73] TBL Licensing LLC

200 Domain Drive, Stratham,

New Hampshire 03885, US, UNITED STATES

[74] FEDERATION OF HONG KONG INDUSTRIES

31/F, Billion Plaza,

8 Cheung Yue Street, Cheung Sha Wan, Kowloon, HONG KONG

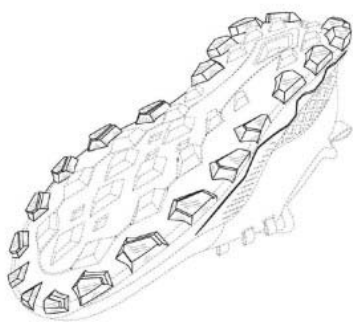

[11] 1913813.0M005

[15] 03-06-2019

[30] 19-12-2018 / US / 29/674,023

[51] Cl. 2-04

[54] 鞋子底部

Footwear sole

[73] TBL Licensing LLC

200 Domain Drive, Stratham,

New Hampshire 03885, US, UNITED STATES

[74] FEDERATION OF HONG KONG INDUSTRIES

31/F, Billion Plaza,

8 Cheung Yue Street, Cheung Sha Wan, Kowloon, HONG KONG

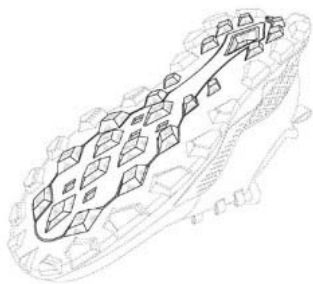

[11] 1913813.0M006

[15] 03-06-2019

[30] 19-12-2018 / US / 29/674,023

[51] Cl. 2-04

[54] 鞋子底部

Footwear sole

[73] TBL Licensing LLC
200 Domain Drive, Stratham,
New Hampshire 03885, US, UNITED STATES

[74] FEDERATION OF HONG KONG INDUSTRIES
31/F, Billion Plaza,
8 Cheung Yue Street, Cheung Sha Wan, Kowloon, HONG KONG

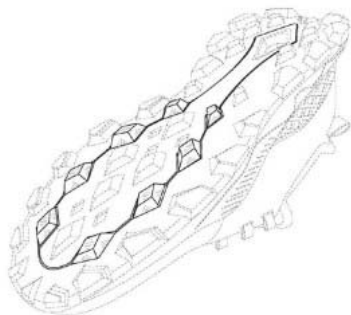

[11] 1913813.0M007

[15] 03-06-2019

[30] 19-12-2018 / US / 29/674,023

[51] Cl. 2-04

[54] 鞋子底部

Footwear sole

[73] TBL Licensing LLC
200 Domain Drive, Stratham,
New Hampshire 03885, US, UNITED STATES

[74] FEDERATION OF HONG KONG INDUSTRIES
31/F, Billion Plaza,
8 Cheung Yue Street, Cheung Sha Wan, Kowloon, HONG KONG

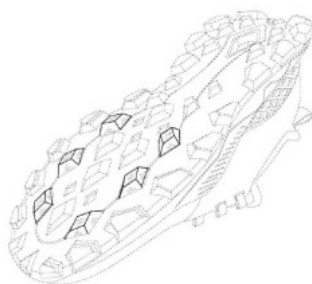

[11] 1913813.0M008

[15] 03-06-2019

[30] 19-12-2018 / US / 29/674,023

[51] Cl. 2-04

[54] 鞋子底部

Footwear sole

[73] TBL Licensing LLC

200 Domain Drive, Stratham,

New Hampshire 03885, US, UNITED STATES

[74] FEDERATION OF HONG KONG INDUSTRIES

31/F, Billion Plaza,

8 Cheung Yue Street, Cheung Sha Wan, Kowloon, HONG KONG

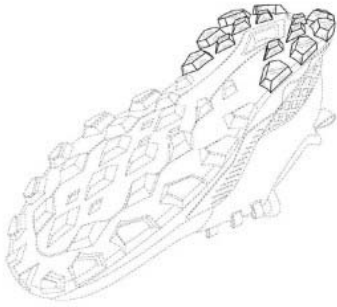

[11] 1913813.0M009

[15] 03-06-2019

[30] 19-12-2018 / US / 29/674,023

[51] Cl. 2-04

[54] 鞋子底部

Footwear sole

[73] TBL Licensing LLC

200 Domain Drive, Stratham,

New Hampshire 03885, US, UNITED STATES

[74] FEDERATION OF HONG KONG INDUSTRIES

31/F, Billion Plaza,

8 Cheung Yue Street, Cheung Sha Wan, Kowloon, HONG KONG

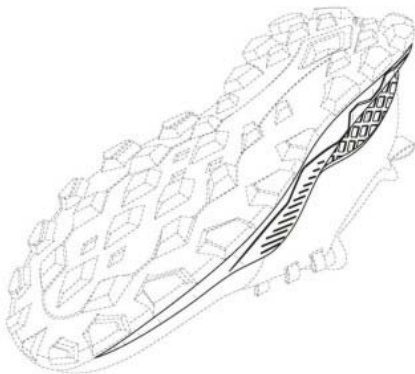

[11] 1913813.0M010

[15] 03-06-2019

[30] 19-12-2018 / US / 29/674,023

[51] Cl. 2-04

[54] 鞋子底部

Footwear sole

[73] TBL Licensing LLC

200 Domain Drive, Stratham,

New Hampshire 03885, US, UNITED STATES

[74] FEDERATION OF HONG KONG INDUSTRIES

31/F, Billion Plaza,

8 Cheung Yue Street, Cheung Sha Wan, Kowloon, HONG KONG

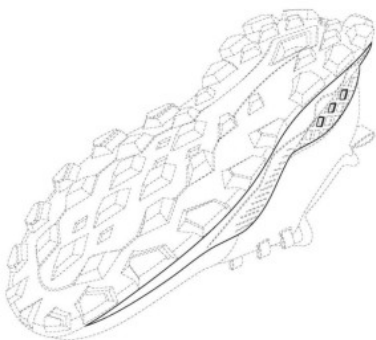

[11] 1913820.5

[15] 04-06-2019

[51] Cl. 28-03

[54] 化妝品包裝用噴霧容器

Spray container for cosmetic packaging

[73] AMOREPACIFIC CORPORATION

100, Hangang-daero, Yongsan-gu, Seoul,

KOREA, REPUBLIC OF

[74] TRADEMARKCN COMPANY LIMITED

Block A, 4/F., Granville Building,

14 Granville Road, Tsim Sha Tsui, Kowloon,

HONG KONG



[11] 1913821.7

[15] 04-06-2019

[51] Cl. 28-03

[54] 化妝品包裝用噴霧容器

Spray container for cosmetic packaging

[73] AMOREPACIFIC CORPORATION

100, Hangang-daero, Yongsan-gu, Seoul,
KOREA, REPUBLIC OF

[74] TRADEMARKCN COMPANY LIMITED

Block A, 4/F., Granville Building,
14 Granville Road, Tsim Sha Tsui, Kowloon,
HONG KONG



[11] 1913823.1M001

[15] 04-06-2019

[30] 19-03-2019 / US / 29/684,226

[51] Cl. 28-01

[54] 藥片

Pill

[73] NOVO NORDISK A/S

NOVO ALLÉ

2880 BAGSVAERD

DENMARK

[74] CHINA PATENT AGENT (HONG KONG) LIMITED

22/F, Great Eagle Centre, 23 Harbour Road,

Wanchai

HONG KONG

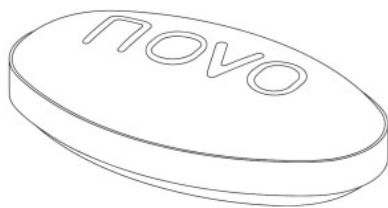

[11] 1913823.1M002

[15] 04-06-2019

[30] 19-03-2019 / US / 29/684,226

[51] Cl. 28-01

[54] 藥片

Pill

[73] NOVO NORDISK A/S

NOVO ALLÉ

2880 BAGSVAERD

DENMARK

[74] CHINA PATENT AGENT (HONG KONG) LIMITED

22/F, Great Eagle Centre, 23 Harbour Road,

Wanchai

HONG KONG

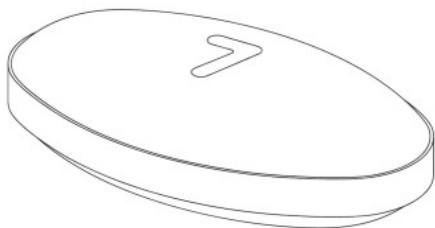

[11] 1913823.1M003

[15] 04-06-2019

[30] 19-03-2019 / US / 29/684,226

[51] Cl. 28-01

[54] 藥片

Pill

[73] NOVO NORDISK A/S

NOVO ALLÉ

2880 BAGSVAERD

DENMARK

[74] CHINA PATENT AGENT (HONG KONG) LIMITED

22/F, Great Eagle Centre, 23 Harbour Road,

Wanchai

HONG KONG

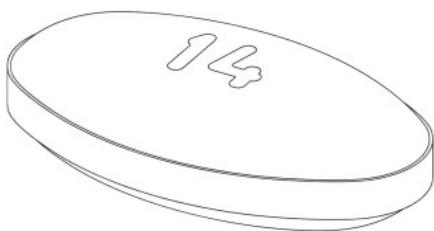

[11] 1913823.1M004

[15] 04-06-2019

[30] 19-03-2019 / US / 29/684,226

[51] Cl. 28-01

[54] 藥片

Pill

[73] NOVO NORDISK A/S

NOVO ALLÉ

2880 BAGSVAERD

DENMARK

[74] CHINA PATENT AGENT (HONG KONG) LIMITED

22/F, Great Eagle Centre, 23 Harbour Road,

Wanchai

HONG KONG

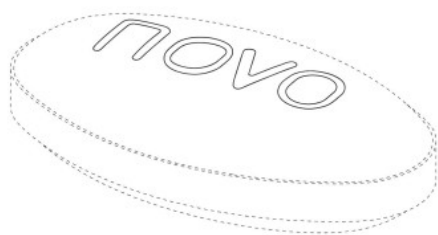

[11] 1913823.1M005

[15] 04-06-2019

[30] 19-03-2019 / US / 29/684,226

[51] Cl. 28-01

[54] 藥片
Pill

[73] NOVO NORDISK A/S
NOVO ALLÉ
2880 BAGSVAERD
DENMARK

[74] CHINA PATENT AGENT (HONG KONG) LIMITED
22/F, Great Eagle Centre, 23 Harbour Road,
Wanchai
HONG KONG

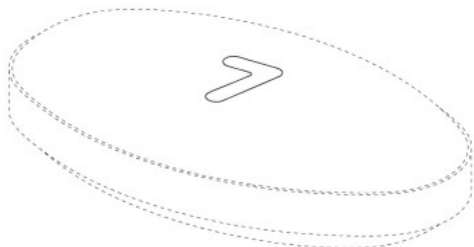

[11] 1913823.1M006

[15] 04-06-2019

[30] 19-03-2019 / US / 29/684,226

[51] Cl. 28-01

[54] 藥片
Pill

[73] NOVO NORDISK A/S
NOVO ALLÉ

2880 BAGSVAERD

DENMARK

[74] CHINA PATENT AGENT (HONG KONG) LIMITED
22/F, Great Eagle Centre, 23 Harbour Road,
Wanchai
HONG KONG

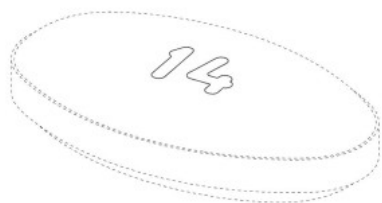

[11] 1913823.1M007

[15] 04-06-2019

[30] 19-03-2019 / US / 29/684,226

[51] Cl. 28-01

[54] 藥片
Pill

[73] NOVO NORDISK A/S
NOVO ALLÉ
2880 BAGSVAERD
DENMARK

[74] CHINA PATENT AGENT (HONG KONG) LIMITED
22/F, Great Eagle Centre, 23 Harbour Road,
Wanchai
HONG KONG

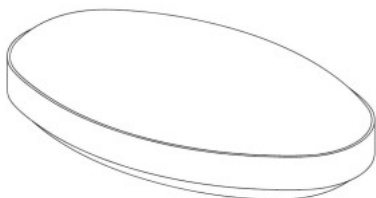

[11] 1913823.1M008

[15] 04-06-2019

[30] 19-03-2019 / US / 29/684,226

[51] Cl. 28-01

[54] 藥片
Pill

[73] NOVO NORDISK A/S
NOVO ALLÉ
2880 BAGSVAERD
DENMARK

[74] CHINA PATENT AGENT (HONG KONG) LIMITED
22/F, Great Eagle Centre, 23 Harbour Road,
Wanchai
HONG KONG

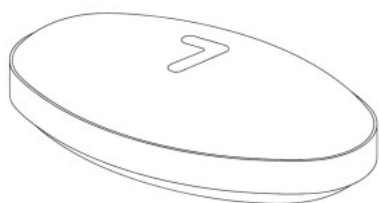

[11] 1913823.1M009

[15] 04-06-2019

[30] 19-03-2019 / US / 29/684,226

[51] Cl. 28-01

[54] 藥片
Pill

[73] NOVO NORDISK A/S
NOVO ALLÉ
2880 BAGSVAERD
DENMARK

[74] CHINA PATENT AGENT (HONG KONG) LIMITED
22/F, Great Eagle Centre, 23 Harbour Road,
Wanchai
HONG KONG

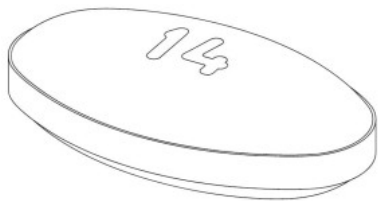

[11] 1913823.1M010

[15] 04-06-2019

[30] 19-03-2019 / US / 29/684,226

[51] Cl. 28-01

[54] 藥片
 Pill

[73] NOVO NORDISK A/S
 NOVO ALLÉ
 2880 BAGSVAERD
 DENMARK

[74] CHINA PATENT AGENT (HONG KONG) LIMITED
 22/F, Great Eagle Centre, 23 Harbour Road,
 Wanchai
 HONG KONG



[11] 1913823.1M011

[15] 04-06-2019

[30] 19-03-2019 / US / 29/684,226

[51] Cl. 28-01

[54] 藥片
Pill

[73] NOVO NORDISK A/S
NOVO ALLÉ
2880 BAGSVAERD
DENMARK

[74] CHINA PATENT AGENT (HONG KONG) LIMITED
22/F, Great Eagle Centre, 23 Harbour Road,
Wanchai
HONG KONG

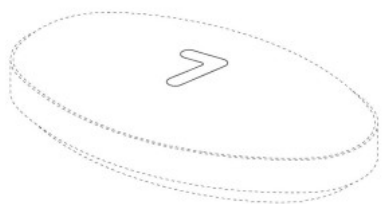

[11] 1913823.1M012

[15] 04-06-2019

[30] 19-03-2019 / US / 29/684,226

[51] Cl. 28-01

[54] 藥片
Pill

[73] NOVO NORDISK A/S
NOVO ALLÉ
2880 BAGSVAERD
DENMARK

[74] CHINA PATENT AGENT (HONG KONG) LIMITED
22/F, Great Eagle Centre, 23 Harbour Road,
Wanchai
HONG KONG

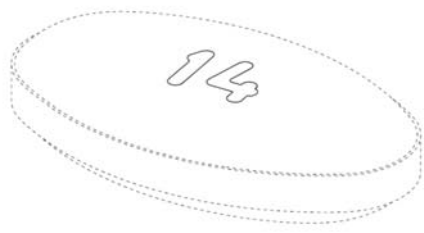



香港特別行政區政府知識產權署外觀設計註冊處

The Government of the Hong Kong Special Administrative Region

Designs Registry, Intellectual Property Department

根據註冊外觀設計條例第28條，下列註冊外觀設計因未繳續期費而停止有效。各組記項按註冊外觀設計停止有效日期及註冊編號先後次序排列。

Registered designs ceased through non-payment of renewal fees under section 28 of the Registered Designs Ordinance. Entries are listed below under their expiry dates.

10-10-2019 - 16-10-2019

10-10-2019	1401927.3	0901711.8
0412275.0	1401928.5	0901712.0
	1401929.7	0901713.2
11-10-2019	1401930.9	0901714.4
0412321.8M001	1401931.1	0901715.7
0412321.8M002	1401932.3	0901716.9M003
0901669.8	1401933.5	0901716.9M004
0901671.2M001	1401934.7	1401951.3
0901671.2M002	1401935.0	1401953.7
0901671.2M003	1401937.4	1401955.2M001
0901671.2M004	9911358.9M001	1401955.2M002
0901671.2M005	9911358.9M002	9911383.1
0901671.2M006		
0901671.2M007	13-10-2019	16-10-2019
0901671.2M008	0412343.4	1401959.0
0901671.2M009	1401941.2	1401960.2
0901671.2M010	1401942.4M001	1401962.6
0901671.2M011	1401943.6	1401965.3M001
0901671.2M012	9911363.9	1401965.3M002
0901671.2M013		1401965.3M003
0901671.2M014	14-10-2019	1401966.5M001
0901671.2M015	0901695.3	1401966.5M003
0901675.1	0901701.7	1401967.7
	0901702.9	1401970.3
12-10-2019	0901705.6M002	1401971.5
0412337.2	1401944.8	1501676.1
0901685.2	1401945.1	
1401921.0	1401946.3	
1401925.9M001		
1401925.9M002	15-10-2019	
1401925.9M003	0901707.0	
1401925.9M004	0901708.2	
1401925.9M006	0901709.4	
1401926.1	0901710.6	



香港特別行政區政府知識產權署外觀設計註冊處

The Government of the Hong Kong Special Administrative Region

Designs Registry, Intellectual Property Department

根據註冊外觀設計規則第 31 條刪除的註冊外觀設計。各組記項按註冊外觀設計 刪除日期及註冊編號先後次序排列。

Registered designs removed under section 31 of the Registered Designs Rules. Entries are listed below under their removal dates.

18-10-2019 - 24-10-2019

18-10-2019	1400705.2
1400674.4	
1400675.7	23-10-2019
1400676.9	0410792.4
1400681.9	1400713.8
1400682.1	9910442.6
1400683.3	9910443.8
1400684.5	9910444.0
1400686.0	
1400687.2	24-10-2019
1400688.4	0900600.2M001
1400689.6	0900600.2M002
1400690.8	0900600.2M003
1400691.0	0900609.1M001
1400692.2	0900609.1M002
1400693.4	0900609.1M003
1400694.6	0900612.7
	1400719.1
20-10-2019	1400720.3M001
0410769.6	1400720.3M002
	1400721.5
21-10-2019	1400722.7
0900578.4	1400729.2
1400695.9M001	1400731.6
1400695.9M002	1402129.1M001
1400696.1	1402129.1M002
1400702.5	1402129.1M003
1401304.1	1402129.1M004
	1402129.1M005
22-10-2019	1402129.1M006
0410782.3M002	1402129.1M007
0900586.1	1402129.1M008
0900587.3	1402129.1M009
0900588.5	1402129.1M010



香港特別行政區政府知識產權署外觀設計註冊處

The Government of the Hong Kong Special Administrative Region

Designs Registry, Intellectual Property Department

根據註冊外觀設計條例第 67 及 76 條, 更正註冊紀錄冊內及已提交文件中的錯誤

Correction of errors in register and in filed documents under sections 67 and 76 of the Registered Designs Ordinance

下列在 19.07.2019 官方公報刊登的更正錯誤的請求已在 20.09.2019 獲准許

The following request for correction of error advertised in the official journal on 19.07.2019 was allowed on 20.09.2019

[11] 1800108.9

[30] EU