

# 香港知識產權公報

Hong Kong Intellectual Property Journal

2021年9月10日  
10 September 2021

## 目錄

## Contents

### 根據註冊外觀設計條例第 25 條註冊的外觀設計

### **Designs Registered under section 25 of the Registered Designs Ordinance**

按註冊編號排列

Arranged by Registration Number

### 根據註冊外觀設計條例(第 522 章)公布的其他公告

### **Other Notices Published under the Registered Designs Ordinance (Cap. 522)**

根據註冊外觀設計條例第 28 條，註冊外觀設計因未繳續期費而停止有效

Registered designs ceased through non-payment of renewal fees under section 28 of the Registered Designs Ordinance

根據註冊外觀設計規則第 31 條刪除的註冊外觀設計

Registered designs removed under section 31 of the Registered Designs Rules

根據註冊外觀設計條例第 67 及 76 條，更正註冊紀錄冊內及已提交文件中的錯誤

Correction of Errors in Register and in Filed Documents under sections 67 and 76 of the Registered Designs Ordinance

根據註冊外觀設計條例第 76 條，更正已提交文件中的錯誤

Correction of errors in filed documents under section 76 of the Registered Designs Ordinance

### 以下事項沒有記錄

### **No Records for the Following Matters**

根據註冊外觀設計條例第 30 條放棄的外觀設計的註冊

Surrender of Registration of Design under section 30 of the Registered Designs Ordinance

根據註冊外觀設計規則第 37 條，向處長作出轉介

Reference to Registrar under section 37 of the Registered Designs Rules

根據註冊外觀設計條例第 45 條，撤銷註冊

Revocation of Registration under section 45 of the Registered Designs Ordinance

根據註冊外觀設計規則第 46 條，向法院作出轉介

Reference to Court under section 46 of the Registered Designs Rules

根據註冊外觀設計規則第 63 條對不符合規定之處作出糾正

Rectification of Irregularities under section 63 of the Registered Designs Rules

根據註冊外觀設計條例第 66 條，糾正註冊紀錄冊

Rectification of Register under section 66 of the Registered Designs Ordinance

根據註冊外觀設計條例第 67 條 更正註冊紀錄冊內的錯誤

Correction of errors in Register under section 67 of the Registered Designs Ordinance

勘誤

Corrigendum

## 註冊外觀設計公告註釋

### Notes on advertisements of registration of designs

方括號表示下列資料：

Square brackets indicate the following data：

[11] 註冊編號 Registration number / 聯合王國註冊編號 United Kingdom registration number

[15] 註冊日期 Registration date / 當作註冊日期 Deemed registration date / 聯合王國註冊日期 United Kingdom registration date

[17] 註冊有效期屆滿日期 Expiry date of the period of registration

[22] 提交日期 Filing date / 當作提交日期 Deemed filing date / 聯合王國提交日期 United Kingdom filing date

[30] 聲稱享有的優先權（提交日期 / 巴黎公約國或世界貿易組織成員 / 申請編號） Priority claimed (filing date / Paris Convention country or WTO member / application number)

[51] 國際外觀設計分類號（洛迦諾分類號） International Classification of designs (Locarno Classification)

[54] 物品 Article

[55] 外觀設計的表述 Representation of the design

[62] 分開前的申請編號及提交日期 Application number before division and filing date

[66] 過往註冊的聯繫外觀設計註冊編號 / 日期 Registration No. / Date of Previous Registration for Association

[72] 設計人 Designer

[73] 擁有人姓名和地址 Name and address of the owner

[74] 代理人 Agent /送達地址 Address for service



香港特別行政區政府知識產權署外觀設計註冊處

The Government of the Hong Kong Special Administrative Region

Designs Registry, Intellectual Property Department

## 根據註冊外觀設計條例第 25 條註冊的外觀設計

### Designs registered under section 25 of the Registered Designs Ordinance

按註冊編號排列

Arranged by Registration Number

- [11] 1915154.3
- [15] 02-12-2019
- [30] 30-05-2019 / US / 29/693,104
- [51] Cl. 24-02
- [54] 體檢用探針  
Medical examination probe
- [73] EchoNous, Inc.  
8310 154th Ave. NE, Bldg. B  
Redmond, Washington 98052  
UNITED STATES
- [74] Letters & Thoo Limited  
Suite 1008, Prosperity Millennia Plaza,  
663 King's Road,  
Quarry Bay, Hong Kong

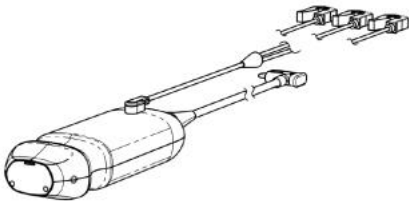

- 
- [11] 2117863.3M001
  - [15] 16-04-2021
  - [30] 16-10-2020 / RU / 2020504819
  - [51] Cl. 29-02
  - [54] 呼吸面罩  
Breathing mask
  - [73] Kirill Kulakovskij  
Libušina 930/12,

360 01 Karlovy Vary,  
Czechia

[74] BARRON & YOUNG INTELLECTUAL PROPERTY LIMITED  
Suite 617, Lakeside 2,  
No. 10 Science Park West Avenue,  
Hong Kong Science Park, Shatin, N.T., Hong Kong

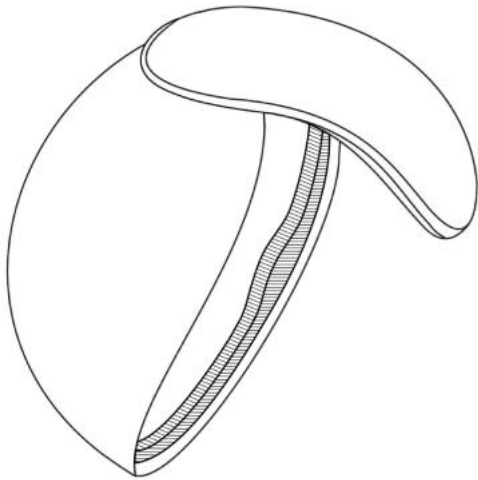

---

[11] 2117863.3M002

[15] 16-04-2021

[51] Cl. 29-02

[54] 呼吸面罩

Breathing mask

[73] Kirill Kulakovskij  
Libušina 930/12,  
360 01 Karlovy Vary,  
Czechia

[74] BARRON & YOUNG INTELLECTUAL PROPERTY LIMITED  
Suite 617, Lakeside 2,  
No. 10 Science Park West Avenue,  
Hong Kong Science Park, Shatin, N.T., Hong Kong

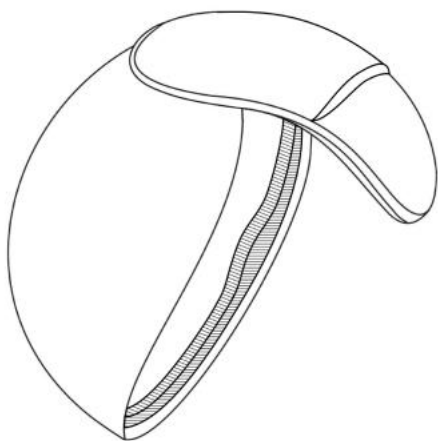

---

[11] 2117879.7M001

[15] 20-04-2021

[30] 22-10-2020 / EU / 008209738-0005

[51] Cl. 27-99

[54] 氣霧生成裝置，特別是煙草加熱裝置

Aerosol generating device, in particular tobacco heating device

[73] Philip Morris Products S.A.

Quai Jeanrenaud 3,

CH-2000 Neuchâtel,

Switzerland

[74] CLT PATENT & TRADEMARK (H.K.) LIMITED

Unit 09, 34/F., Office Tower, Convention Plaza,

No. 1 Harbour Road,

Wanchai, Hong Kong

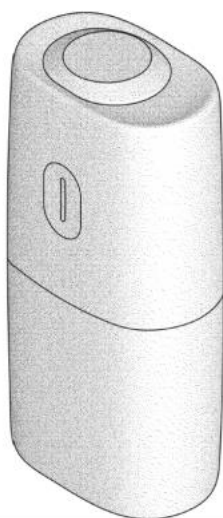



[11] 2117879.7M002

[15] 20-04-2021

[30] 22-10-2020 / EU / 008209738-0008

[51] Cl. 27-99

[54] 氣霧生成裝置，特別是煙草加熱裝置

Aerosol generating device, in particular tobacco heating device

[73] Philip Morris Products S.A.

Quai Jeanrenaud 3,

CH-2000 Neuchâtel,

Switzerland

[74] CLT PATENT & TRADEMARK (H.K.) LIMITED

Unit 09, 34/F., Office Tower, Convention Plaza,

No. 1 Harbour Road,

Wanchai, Hong Kong

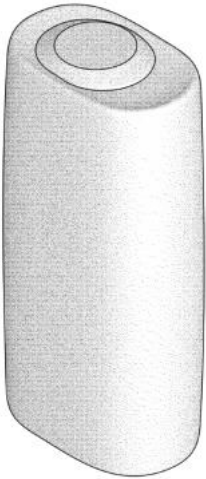

[11] 2117879.7M003

[15] 20-04-2021

[30] 22-10-2020 / EU / 008209738-0020

[51] Cl. 27-99

[54] 氣霧生成裝置，特別是煙草加熱裝置

Aerosol generating device, in particular tobacco heating device

[73] Philip Morris Products S.A.

Quai Jeanrenaud 3,

CH-2000 Neuchâtel,

Switzerland

[74] CLT PATENT & TRADEMARK (H.K.) LIMITED

Unit 09, 34/F., Office Tower, Convention Plaza,

No. 1 Harbour Road,  
Wanchai, Hong Kong

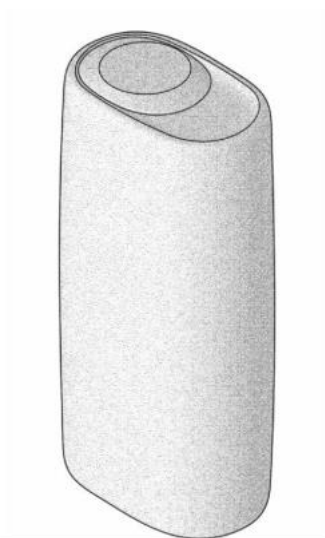

---

[11] 2117908.0M001

[15] 23-04-2021

[30] 12-11-2020 / CA / 199322

[51] Cl. 9-07

[54] 迷你溫室的罩

Dome for a mini green house

[73] MONDI PRODUCTS LTD.

4848 - 349 West Georgia Street,  
Vancouver BC V6B 4A4,  
Canada

[74] CHINAHONGKONG IP LIMITED

1502, 15/F, Capital Centre  
151 Gloucester Road, Wanchai  
Hong Kong  
HONG KONG

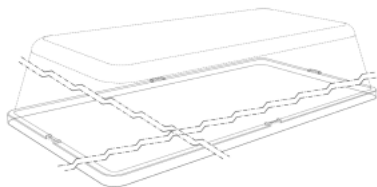

- [11] 2117908.0M002  
[15] 23-04-2021  
[30] 12-11-2020 / CA / 199322  
[51] Cl. 9-07  
[54] 迷你溫室的罩  
Dome for a mini green house  
[73] MONDI PRODUCTS LTD.  
4848 - 349 West Georgia Street,  
Vancouver BC V6B 4A4,  
Canada  
[74] CHINAHONGKONG IP LIMITED  
1502, 15/F, Capital Centre  
151 Gloucester Road, Wanchai  
Hong Kong  
HONG KONG

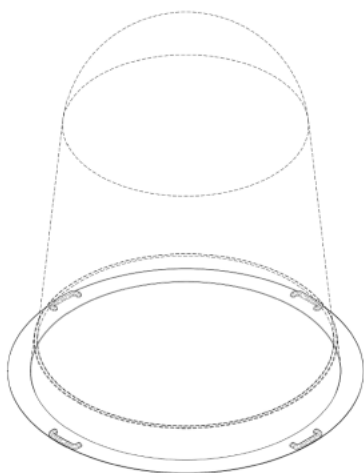

- 
- [11] 2117935.7M001  
[15] 28-04-2021  
[30] 28-10-2020 / JP / 023213 of 2020  
[51] Cl. 10-04  
[54] 身體尺寸測量工具  
Body size measuring tool  
[73] 株式會社 ZOZO  
ZOZO, Inc.  
1-15-16, Midori-cho, Inage-ku,  
Chiba-shi, Chiba, 263-0023,  
Japan  
[74] CHINAHONGKONG IP LIMITED  
1502, 15/F, Capital Centre  
151 Gloucester Road, Wanchai

Hong Kong  
HONG KONG



---

[11] 2117935.7M002

[15] 28-04-2021

[30] 28-10-2020 / JP / 023214 of 2020

[51] Cl. 10-04

[54] 身體尺寸測量工具

Body size measuring tool

[73] 株式會社 ZOZO

ZOZO, Inc.

1-15-16, Midori-cho, Inage-ku,

Chiba-shi, Chiba, 263-0023,

Japan

[74] CHINAHONGKONG IP LIMITED

1502, 15/F, Capital Centre

151 Gloucester Road, Wanchai

Hong Kong

HONG KONG



---

[11] 2118213.6

[15] 24-06-2021

[51] Cl. 19-07

[54] 教學用漢字字母表

Chinese alphabet list for teaching

[73] 鄧劉達  
香港新界  
將軍澳蓬萊路 8 號  
清水灣半島五座 49 樓 E 室

[74] 鄧劉達  
香港新界  
將軍澳蓬萊路 8 號  
清水灣半島五座 49 樓 E 室



- 
- [11] 2118219.9M001
  - [15] 22-06-2021
  - [30] 07-02-2021 / CN / 202130089852.3
  - [51] C1. 10-05
  - [54] 校準裝置  
Calibration apparatus
  - [73] 深圳市道通科技股份有限公司  
中國內地  
廣東省深圳市南山區  
南山智園 B1 棟 6、7、8、10 層
  - [74] 百睿知識產權有限公司  
香港新界  
沙田香港科學園  
科技大道西 10 號浚湖樓 617 室

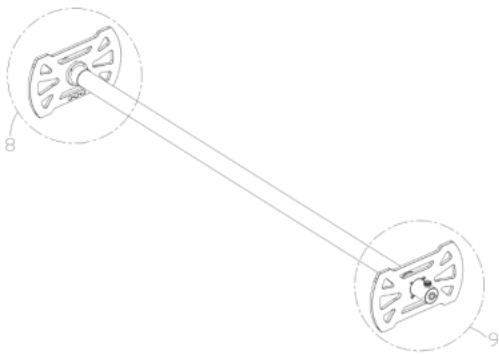

---

[11] 2118219.9M002

[15] 22-06-2021

[30] 07-02-2021 / CN / 202130089772.8

[51] C1. 10-05

[54] 校準支架裝置

Calibration support apparatus

[73] 深圳市道通科技股份有限公司

中國內地

廣東省深圳市南山區

南山智園 B1 棟 6、7、8、10 層

[74] 百睿知識產權有限公司

香港新界

沙田香港科學園

科技大道西 10 號浚湖樓 617 室

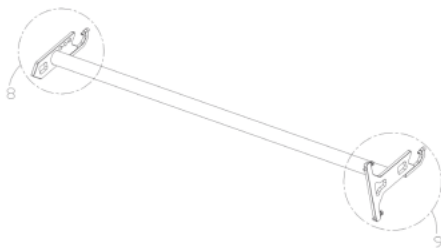

---

[11] 2118221.3M001

[15] 23-06-2021

[30] 01-04-2021 / KR / 30-2021-0015883

[51] C1. 24-01

[54] 超聲波治療設備用工作頭

Tip for ultrasound therapy device

[73] 科萊希思有限公司

CLASSYS INC.

240, Teheran-ro,

Gangnam-gu, Seoul 06221,

Korea, Republic of

[74] CHINA PATENT AGENT (HONG KONG) LIMITED

22/F, Great Eagle Centre,

23 Harbour Road,

Wanchai, Hong Kong

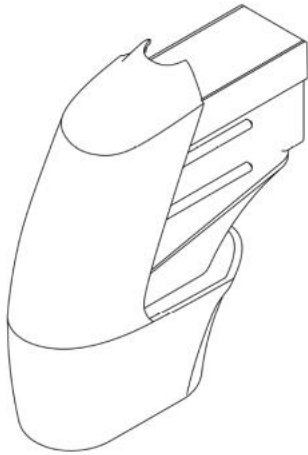

---

[11] 2118221.3M002

[15] 23-06-2021

[30] 01-04-2021 / KR / 30-2021-0015884

[51] Cl. 24-01

[54] 超聲波治療設備用工作頭

Tip for ultrasound therapy device

[73] 科萊希思有限公司

CLASSYS INC.

240, Teheran-ro,

Gangnam-gu, Seoul 06221,

Korea, Republic of

[74] CHINA PATENT AGENT (HONG KONG) LIMITED

22/F, Great Eagle Centre,

23 Harbour Road,

Wanchai, Hong Kong

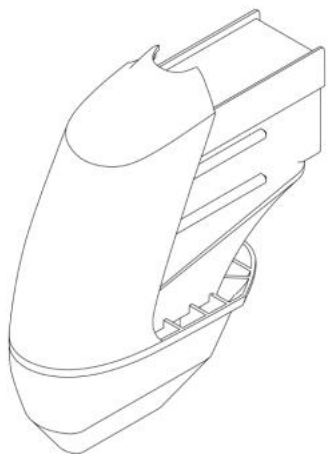

---

[11] 2118221.3M003

[15] 23-06-2021

[30] 01-04-2021 / KR / 30-2021-0015885

[51] Cl. 24-01

[54] 超聲波治療設備用工作頭

Tip for ultrasound therapy device

[73] 科萊希思有限公司

CLASSYS INC.

240, Teheran-ro,

Gangnam-gu, Seoul 06221,

Korea, Republic of

[74] CHINA PATENT AGENT (HONG KONG) LIMITED

22/F, Great Eagle Centre,

23 Harbour Road,

Wanchai, Hong Kong

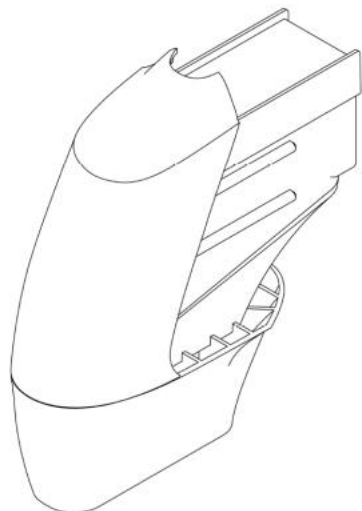



- [11] 2118222.5  
[15] 23-06-2021  
[30] 01-04-2021 / KR / 30-2021-0015886  
[51] Cl. 24-01  
[54] 超聲波治療設備用手柄  
Handpiece for ultrasound therapy device  
[73] 科萊希思有限公司  
CLASSYS INC.  
240, Teheran-ro,  
Gangnam-gu, Seoul 06221,  
Korea, Republic of  
[74] CHINA PATENT AGENT (HONG KONG) LIMITED  
22/F, Great Eagle Centre,  
23 Harbour Road,  
Wanchai, Hong Kong



- 
- [11] 2118223.7  
[15] 23-06-2021  
[30] 01-04-2021 / KR / 30-2021-0015880  
[51] Cl. 24-01  
[54] 超聲波治療設備  
Ultrasound therapy device  
[73] 科萊希思有限公司  
CLASSYS INC.  
240, Teheran-ro,  
Gangnam-gu, Seoul 06221,  
Korea, Republic of  
[74] CHINA PATENT AGENT (HONG KONG) LIMITED  
22/F, Great Eagle Centre,

23 Harbour Road,  
Wanchai, Hong Kong

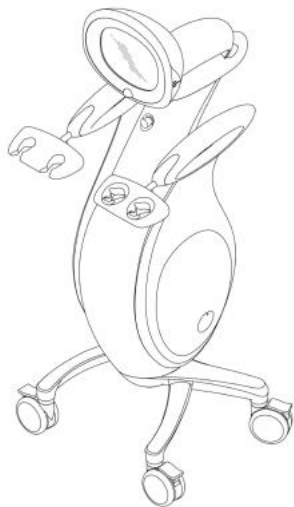

---

[11] 2118224.9M001

[15] 23-06-2021

[30] 01-04-2021 / KR / 30-2021-0015877

[51] Cl. 24-01

[54] 高頻率治療設備用工作頭  
Tip for high frequency therapy device

[73] 科萊希思有限公司  
CLASSYS INC.  
240, Teheran-ro,  
Gangnam-gu, Seoul 06221,  
Korea, Republic of

[74] CHINA PATENT AGENT (HONG KONG) LIMITED  
22/F, Great Eagle Centre,  
23 Harbour Road,  
Wanchai, Hong Kong

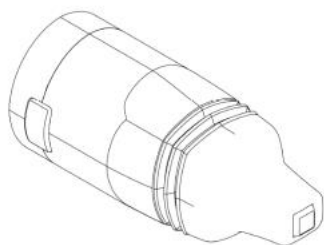

- [11] 2118224.9M002  
[15] 23-06-2021  
[30] 01-04-2021 / KR / 30-2021-0015878  
[51] C1. 24-01  
[54] 高頻率治療設備用工作頭  
Tip for high frequency therapy device  
[73] 科萊希思有限公司  
CLASSYS INC.  
240, Teheran-ro,  
Gangnam-gu, Seoul 06221,  
Korea, Republic of  
[74] CHINA PATENT AGENT (HONG KONG) LIMITED  
22/F, Great Eagle Centre,  
23 Harbour Road,  
Wanchai, Hong Kong

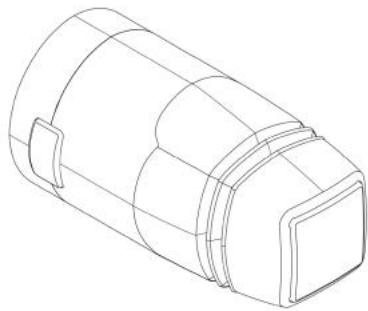

- 
- [11] 2118224.9M003  
[15] 23-06-2021  
[30] 01-04-2021 / KR / 30-2021-0015879  
[51] C1. 24-01  
[54] 高頻率治療設備用工作頭  
Tip for high frequency therapy device  
[73] 科萊希思有限公司  
CLASSYS INC.  
240, Teheran-ro,  
Gangnam-gu, Seoul 06221,  
Korea, Republic of  
[74] CHINA PATENT AGENT (HONG KONG) LIMITED  
22/F, Great Eagle Centre,  
23 Harbour Road,  
Wanchai, Hong Kong

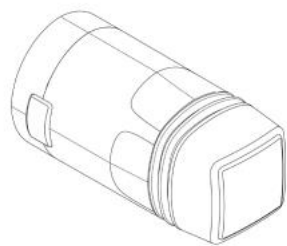

---

[11] 2118227.6

[15] 23-06-2021

[30] 01-04-2021 / KR / 30-2021-0015871

[51] Cl. 24-01

[54] 高頻率治療設備

High frequency therapy device

[73] 科萊希思有限公司

CLASSYS INC.

240, Teheran-ro, Gangnam-gu,

Seoul 06221,

Korea, Republic of

[74] CHINA PATENT AGENT (HONG KONG) LIMITED

22/F, Great Eagle Centre,

23 Harbour Road,

Wanchai, Hong Kong



---

[11] 2118228.8

[15] 23-06-2021

[30] 01-04-2021 / KR / 30-2021-0015887

[51] Cl. 24-01

[54] 超聲波治療設備用工作頭

Tip for ultrasound therapy device

[73] 科萊希思有限公司  
CLASSYS INC.  
240, Teheran-ro, Gangnam-gu,  
Seoul 06221,  
Korea, Republic of

[74] CHINA PATENT AGENT (HONG KONG) LIMITED  
22/F, Great Eagle Centre,  
23 Harbour Road,  
Wanchai, Hong Kong

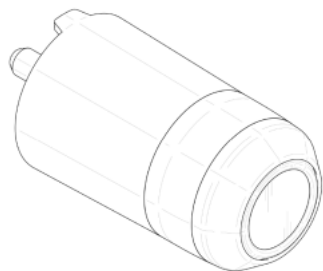

---

[11] 2118229.0

[15] 23-06-2021

[30] 01-04-2021 / KR / 30-2021-0015876

[51] Cl. 24-01

[54] 高頻率治療設備用工作頭  
Tip for high frequency therapy device

[73] 科萊希思有限公司  
CLASSYS INC.  
240, Teheran-ro, Gangnam-gu,  
Seoul 06221,  
Korea, Republic of

[74] CHINA PATENT AGENT (HONG KONG) LIMITED  
22/F, Great Eagle Centre,  
23 Harbour Road,  
Wanchai, Hong Kong

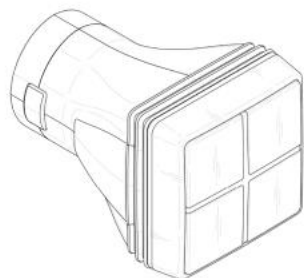

- [11] 2118230.2  
[15] 23-06-2021  
[30] 01-04-2021 / KR / 30-2021-0015875  
[51] Cl. 24-01  
[54] 高頻率治療設備用手柄  
Handpiece for high frequency therapy device  
[73] 科萊希思有限公司  
CLASSYS INC.  
240, Teheran-ro, Gangnam-gu,  
Seoul 06221,  
Korea, Republic of  
[74] CHINA PATENT AGENT (HONG KONG) LIMITED  
22/F, Great Eagle Centre,  
23 Harbour Road,  
Wanchai, Hong Kong



- 
- [11] 2118235.3  
[15] 24-06-2021  
[51] Cl. 11-01  
[54] 手鏈  
Bracelet  
[73] 周生生珠寶金行有限公司  
Chow Sang Sang Jewellery Company Limited  
4/F., Chow Sang Sang Building,  
229 Nathan Road,  
Kowloon, Hong Kong  
[74] HONG KONG INTELLECTUAL PROPERTY AGENT LIMITED  
Unit 230, 2/F, Building 12W,  
No. 12 Science Park West Avenue,  
Phase 3, Hong Kong Science Park,  
Pak Shek Kok, N.T., Hong Kong



---

[11] 2118236.5M001

[15] 24-06-2021

[30] 31-03-2021 / CH, TR, GB, EU / DM/213 551

[51] Cl. 10-02

[54] 手錶

Wristwatch

[73] ETA SA Manufacture Horlogere Suisse

CH-2540 Grenchen,

Switzerland

[74] SPRUSON & FERGUSON (HONG KONG) LIMITED

5001 Hopewell Centre,

183 Queen's Road East,

Wan Chai, Hong Kong



- [11] 2118236.5M002  
[15] 24-06-2021  
[30] 31-03-2021 / CH, TR, GB, EU / DM/213 551  
[51] Cl. 10-02  
[54] 手錶  
Wristwatch  
[73] ETA SA Manufacture Horlogere Suisse  
CH-2540 Grenchen,  
Switzerland  
[74] SPRUSON & FERGUSON (HONG KONG) LIMITED  
5001 Hopewell Centre,  
183 Queen's Road East,  
Wan Chai, Hong Kong



- 
- [11] 2118237.7  
[15] 24-06-2021  
[30] 25-12-2020 / JP / 028342 of 2020  
[51] Cl. 12-15  
[54] 汽車輪胎  
Automobile tire  
[73] The Yokohama Rubber Co., Ltd.  
36-11, Shimbashi 5-chome,  
Minato-ku, Tokyo 105-8685,  
Japan  
[74] EMILY YIP & CO LIMITED  
1st Floor, Kingsfield Centre,  
18 Shell Street,  
Fortress Hill, Hong Kong



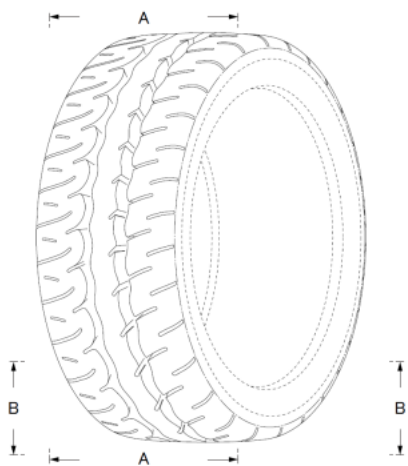

[11] 2118238.9

[15] 24-06-2021

[30] 25-12-2020 / JP / 028341 of 2020

[51] Cl. 12-15

[54] 汽車輪胎

Automobile tire

[73] The Yokohama Rubber Co., Ltd.

36-11, Shimbashi 5-chome,  
Minato-ku, Tokyo 105-8685,  
Japan

[74] EMILY YIP & CO LIMITED

1st Floor, Kingsfield Centre,  
18 Shell Street,  
Fortress Hill, Hong Kong

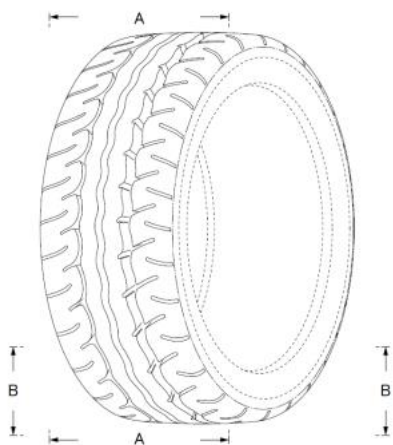

[11] 2118239.1

- [15] 24-06-2021
- [30] 25-12-2020 / JP / 028340 of 2020
- [51] Cl. 12-15
- [54] 汽車輪胎  
Automobile tire
- [73] The Yokohama Rubber Co., Ltd.  
36-11, Shimbashi 5-chome,  
Minato-ku, Tokyo 105-8685,  
Japan
- [74] EMILY YIP & CO LIMITED  
1st Floor, Kingsfield Centre,  
18 Shell Street,  
Fortress Hill, Hong Kong

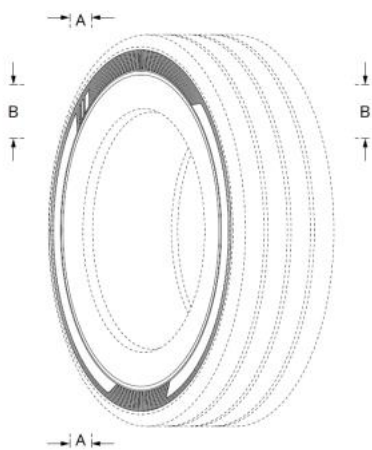

- 
- [11] 2118240.3
- [15] 25-06-2021
- [30] 17-06-2021 / EU / 008580864
- [51] Cl. 9-09
- [54] 垃圾桶  
Bin
- [73] Brabantia Nederland B.V.  
De Haak 14,  
5555 XK Valkenswaard,  
Netherlands
- [74] NTD PATENT & TRADE MARK AGENCY LIMITED  
Units 1805-6, 18/F.,  
Greenfield Tower, Concordia Plaza,  
No. 1 Science Museum Road,  
Tsimshatsui East, Kowloon, Hong Kong



---

[11] 2118241.5

[15] 25-06-2021

[30] 26-03-2021 / CH / 145880

[51] Cl. 10-07

[54] 錶面

Watch dial

[73] ROLEX SA

rue François-Dussaud 3-5-7,

1211 Genève 26,

Switzerland

[74] DEACONS

5th Floor, Alexandra House,

Central,

Hong Kong



---

[11] 2118242.7M001

[15] 25-06-2021

[51] Cl. 3-01

[54] 行李箱

Luggage

[73] 新秀麗 IP 控股有限責任公司

Samsonite IP Holdings S.à r.l.

13-15 avenue de la Liberté,

L-1931 Luxembourg,

Luxembourg

[74] WILKINSON & GRIST

6th Floor, Prince's Building,

Chater Road,

Hong Kong

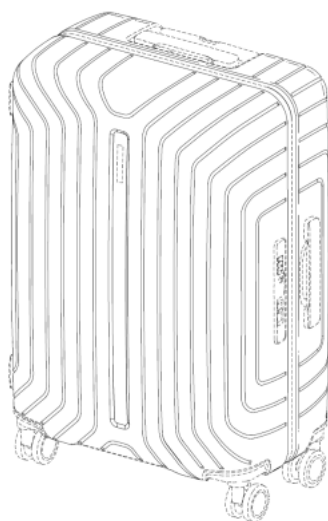

---

[11] 2118242.7M002

[15] 25-06-2021

[51] Cl. 3-01

[54] 行李箱

Luggage

[73] 新秀麗 IP 控股有限責任公司

Samsonite IP Holdings S.à r.l.

13-15 avenue de la Liberté,

L-1931 Luxembourg,

Luxembourg

[74] WILKINSON & GRIST

6th Floor, Prince's Building,

Chater Road,

Hong Kong

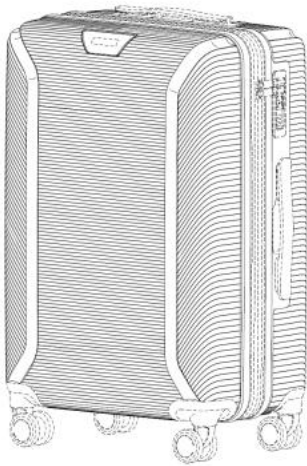

---

[11] 2118243.9M001

[15] 25-06-2021

[30] 21-01-2021 / CA, AM, AZ, BZ, BA, GE, LI, MK, MD, MC, MN, ME,  
MA, NO, OM, SG, CH, TN, TR, UA, GB, EU, AL, KG / DM/212 440

[51] Cl. 11-01

[54] 指環  
Ring

[73] Harry Winston SA  
Chemin du Tourbillon 8,  
CH-1228 Plan-les-Ouates,  
Switzerland

[74] SPRUSON & FERGUSON (HONG KONG) LIMITED  
5001 Hopewell Centre,  
183 Queen's Road East,  
Wan Chai, Hong Kong



---

[11] 2118243.9M002

[15] 25-06-2021

[30] 21-01-2021 / CA, AM, AZ, BZ, BA, GE, LI, MK, MD, MC, MN, ME, MA, NO, OM, SG, CH, TN, TR, UA, GB, EU, AL, KG / DM/212 440

[51] Cl. 11-01

[54] 指環  
Ring

[73] Harry Winston SA  
Chemin du Tourbillon 8,  
CH-1228 Plan-les-Ouates,  
Switzerland

[74] SPRUSON & FERGUSON (HONG KONG) LIMITED  
5001 Hopewell Centre,  
183 Queen's Road East,  
Wan Chai, Hong Kong



---

[11] 2118243.9M003

[15] 25-06-2021

[30] 21-01-2021 / CA, AM, AZ, BZ, BA, GE, LI, MK, MD, MC, MN, ME, MA, NO, OM, SG, CH, TN, TR, UA, GB, EU, AL, KG / DM/212 440

[51] Cl. 11-01

[54] 項鍊  
Necklace

[73] Harry Winston SA  
Chemin du Tourbillon 8,  
CH-1228 Plan-les-Ouates,  
Switzerland

[74] SPRUSON & FERGUSON (HONG KONG) LIMITED  
5001 Hopewell Centre,  
183 Queen's Road East,  
Wan Chai, Hong Kong



---

[11] 2118243.9M004

[15] 25-06-2021

[30] 21-01-2021 / CA, AM, AZ, BZ, BA, GE, LI, MK, MD, MC, MN, ME, MA, NO, OM, SG, CH, TN, TR, UA, GB, EU, AL, KG / DM/212 440

[51] Cl. 11-01

[54] 耳環

Earrings

[73] Harry Winston SA

Chemin du Tourbillon 8,  
CH-1228 Plan-les-Ouates,  
Switzerland

[74] SPRUSON & FERGUSON (HONG KONG) LIMITED

5001 Hopewell Centre,  
183 Queen's Road East,  
Wan Chai, Hong Kong



---

[11] 2118243.9M005

[15] 25-06-2021

[30] 21-01-2021 / CA, AM, AZ, BZ, BA, GE, LI, MK, MD, MC, MN, ME, MA, NO, OM, SG, CH, TN, TR, UA, GB, EU, AL, KG / DM/212 440

[51] Cl. 11-01

[54] 耳環

Earrings

[73] Harry Winston SA

Chemin du Tourbillon 8,  
CH-1228 Plan-les-Ouates,  
Switzerland

[74] SPRUSON & FERGUSON (HONG KONG) LIMITED

5001 Hopewell Centre,  
183 Queen's Road East,  
Wan Chai, Hong Kong

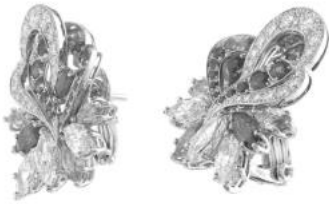

---

[11] 2118243.9M006

[15] 25-06-2021

[30] 21-01-2021 / CA, AM, AZ, BZ, BA, GE, LI, MK, MD, MC, MN, ME,  
MA, NO, OM, SG, CH, TN, TR, UA, GB, EU, AL, KG / DM/212 440

[51] Cl. 11-01

[54] 項鍊

Necklace

[73] Harry Winston SA

Chemin du Tourbillon 8,  
CH-1228 Plan-les-Ouates,  
Switzerland

[74] SPRUSON & FERGUSON (HONG KONG) LIMITED

5001 Hopewell Centre,  
183 Queen's Road East,  
Wan Chai, Hong Kong





[11] 2118245.4M001

[15] 28-06-2021

[30] 25-01-2021 / SG, CH, TR, GB, EU / DM/212 729

[51] Cl. 10-02

[54] 錶

Watch

[73] HAMILTON INTERNATIONAL AG (HAMILTON INTERNATIONAL SA)  
(HAMILTON INTERNATIONAL LTD.)

Mattenstrasse 149,  
2503 Biel/Bienne,  
Switzerland

[74] SPRUSON & FERGUSON (HONG KONG) LIMITED

5001 Hopewell Centre,  
183 Queen's Road East,  
Wan Chai, Hong Kong



---

[11] 2118245.4M002

[15] 28-06-2021

[30] 25-01-2021 / SG, CH, TR, GB, EU / DM/212 729

[51] Cl. 10-07

[54] 錶殼

Watch case

[73] HAMILTON INTERNATIONAL AG (HAMILTON INTERNATIONAL SA)  
(HAMILTON INTERNATIONAL LTD.)

Mattenstrasse 149,  
2503 Biel/Bienne,  
Switzerland

[74] SPRUSON & FERGUSON (HONG KONG) LIMITED

5001 Hopewell Centre,  
183 Queen's Road East,  
Wan Chai, Hong Kong

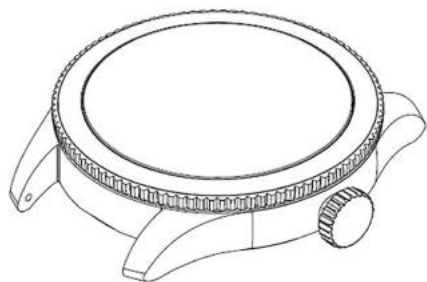

---

[11] 2118245.4M003

[15] 28-06-2021

[30] 25-01-2021 / SG, CH, TR, GB, EU / DM/212 729

[51] Cl. 10-07

[54] 錶面  
Dial

[73] HAMILTON INTERNATIONAL AG (HAMILTON INTERNATIONAL SA)  
(HAMILTON INTERNATIONAL LTD.)  
Mattenstrasse 149,  
2503 Biel/Bienne,  
Switzerland

[74] SPRUSON & FERGUSON (HONG KONG) LIMITED  
5001 Hopewell Centre,  
183 Queen's Road East,  
Wan Chai, Hong Kong

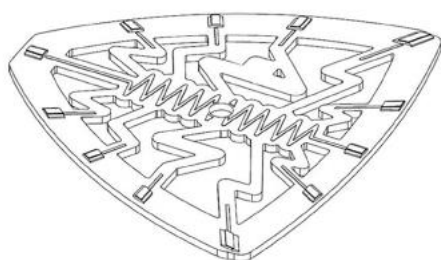

---

[11] 2118247.8

[15] 28-06-2021

[30] 25-01-2021 / BA, GE, MA, NO, OM, SG, CH, TN, TR, UA, GB, VN,  
EU / DM/212 692

[51] Cl. 10-02

[54] 手錶

Wristwatch

[73] RADO UHREN AG (RADO WATCH CO. LTD.) (MONTRES RADO SA)

Bielstrasse 45,  
CH-2543 Lengnau,  
Switzerland

[74] SPRUSON & FERGUSON (HONG KONG) LIMITED

5001 Hopewell Centre,  
183 Queen's Road East,  
Wan Chai, Hong Kong

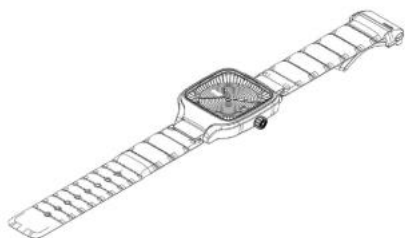

---

[11] 2118248.0

[15] 28-06-2021

[51] Cl. 14-01

[54] 藍牙音箱

Speaker

[73] 酷博創意有限公司

The Coop Idea Ltd.  
Flat 11, Block B, 5/F, Hong Kong Industrial Centre,  
489-491 Castle Peak Road,  
Kowloon, Hong Kong

[74] Propagate Intellectual Property Limited

A5, 16/F., TML Tower,  
3 Hoi Shing Road,  
Tsuen Wan, Hong Kong

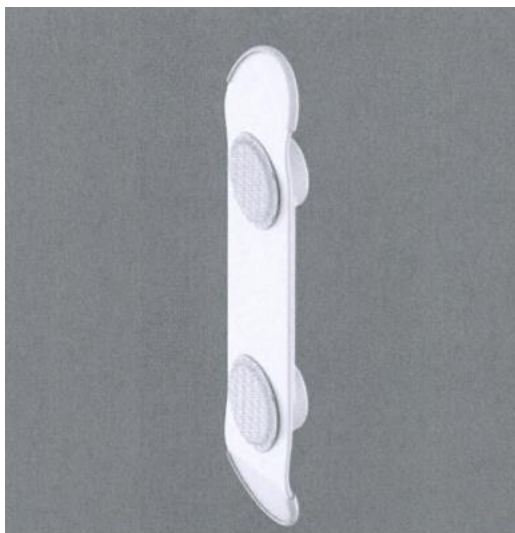

[11] 2118249.2

[15] 28-06-2021

[51] Cl. 9-03

[54] 咖啡豆盒

Coffee bean carton

[73] 黃冠旌以 co:llab coffee 之名營業

Wong Koon Shing Wilson Trading as co:llab coffee

Room B, 14/F, Bank Tower,

351-353 King's Road,

North Point, Hong Kong

[74] Wong Koon Shing Wilson

Room B, 14/F, Bank Tower,

351-353 King's Road,

North Point, Hong Kong



- [11] 2118250.4  
[15] 28-06-2021  
[30] 06-01-2021 / EU / 008387401-0001  
[51] Cl. 9-01  
[54] 瓶  
Flask  
[73] GUERLAIN  
68 Avenue des Champs-Élysées,  
75008 Paris,  
France  
[74] WENPING PATENT & TRADE MARK AGENT LIMITED  
1701 Tung Wai Commercial Building,  
111 Gloucester Road,  
Hong Kong



- 
- [11] 2118252.8M001  
[15] 28-06-2021  
[30] 26-02-2021 / NO, SG, CH, GB, EU / DM/212 952  
[51] Cl. 7-01  
[54] 玻璃瓶  
Carafe  
[73] Pi-Design AG  
Kantonsstrasse 100,  
CH-6234 Triengen,  
Switzerland  
[74] WENPING PATENT & TRADE MARK AGENT LIMITED  
1701 Tung Wai Commercial Building,  
111 Gloucester Road,  
Hong Kong



---

[11] 2118252.8M002

[15] 28-06-2021

[30] 26-02-2021 / NO, SG, CH, GB, EU / DM/212 952

[51] Cl. 7-01

[54] 玻璃瓶  
Carafe

[73] Pi-Design AG  
Kantonsstrasse 100,  
CH-6234 Triengen,  
Switzerland

[74] WENPING PATENT & TRADE MARK AGENT LIMITED  
1701 Tung Wai Commercial Building,  
111 Gloucester Road,  
Hong Kong





香港特別行政區政府知識產權署外觀設計註冊處

The Government of the Hong Kong Special Administrative Region

Designs Registry, Intellectual Property Department

根據註冊外觀設計條例第 28 條，下列註冊外觀設計因未繳續期費而停止有效。

各組記項按註冊外觀設計停止有效日期及註冊編號先後次序排列。

**Registered designs ceased through non-payment of renewal fees under section 28 of the Registered Designs Ordinance. Entries are listed below under their expiry dates.**

**18-06-2021 - 23-06-2021**

**18-06-2021**

0110909.1  
0601563.0

1601181.1M001  
1601181.1M002  
1601181.1M003  
1601181.1M004

1601201.5M001  
1601201.5M002  
1601201.5M004  
1601203.9M003

**19-06-2021**

0601580.6M002  
0601582.0M001  
0601582.0M002  
0601582.0M003  
0601582.0M004

1601181.1M005  
1601181.1M006  
1601181.1M007  
1601181.1M008

1601203.9M004  
1601203.9M005  
1601203.9M006

**20-06-2021**

1101038.4  
1101039.6  
1101040.8  
1101041.0  
1101042.2  
1101043.4  
1101044.6  
1101045.9  
1101046.1  
1101049.7  
1101050.9  
1101051.1M001  
1101051.1M002  
1101052.3  
1601178.5M001  
1601178.5M002  
1601180.9M001  
1601180.9M002  
1601180.9M003  
1601180.9M004  
1601180.9M005  
1601180.9M006  
1601180.9M007  
1601180.9M008

0601584.4  
0601585.7  
0601587.1  
0601594.5  
1101067.5  
1601182.3  
1601185.0  
1601186.2  
1601187.4  
1601188.6  
1601189.8  
1601190.0  
1601191.2  
1601192.4  
1601193.6  
1601194.8  
1601195.1

**22-06-2021**

0601610.1  
1101080.2  
1601205.4  
1601207.8M001  
1601207.8M002  
1601211.6

**23-06-2021**

1101089.1  
1101090.3  
1101094.1  
1601216.7  
1601217.9  
1601218.1  
1601219.3

**21-06-2021**

1101072.5  
1101074.9  
1101077.6  
1601197.5  
1601200.3



香港特別行政區政府知識產權署外觀設計註冊處

The Government of the Hong Kong Special Administrative Region

Designs Registry, Intellectual Property Department

根據註冊外觀設計規則第 31 條刪除的註冊外觀設計。各組記項按註冊外觀設計刪除日期及註冊編號先後次序排列。

**Registered designs removed under section 31 of the Registered Designs Rules. Entries are listed below under their removal dates.**

**20-08-2021 - 26-08-2021**

<b>20-08-2021</b>	0503103.6M004	
1502308.2M002	0503105.1M002	<b>26-08-2021</b>
1502670.9M001	1002437.0	1002458.4
1502670.9M002	1502686.3M001	1002459.6
1502670.9M003	1502686.3M002	1002460.8
1502670.9M004	1502688.7	1002463.4
1502671.1M001	1502690.1	1002464.6
1502671.1M002		1002467.3
1502671.1M003	<b>24-08-2021</b>	1502723.2
1502671.1M004	0503110.1	1502726.9M001
1502675.0	0503118.8	1502728.3M002
1502677.4	0503119.0	1502728.3M003
1502678.6	0503120.2	1502728.3M004
1502679.8	0503121.4	
1502680.0M001	0503122.6	
1502680.0M002	0503123.8	
1502682.4	1002440.6M004	
1600458.8	1502693.7	
	1502696.4M001	
<b>21-08-2021</b>	1502696.4M002	
0503078.2	1502696.4M003	
	1502696.4M004	
<b>22-08-2021</b>	1502697.6M001	
0011840.4	1502697.6M002	
1002418.0		
	<b>25-08-2021</b>	
<b>23-08-2021</b>	0503135.4	
0503101.2M001	1002444.4	
0503101.2M002	1002445.7	
0503101.2M003	1002448.3	
0503101.2M004	1002454.5	
0503103.6M001	1502685.1M002	
0503103.6M002	1502699.0	
0503103.6M003	1502702.8	





香港特別行政區政府知識產權署外觀設計註冊處

The Government of the Hong Kong Special Administrative Region

Designs Registry, Intellectual Property Department

**根據註冊外觀設計條例第 67 及 76 條，更正註冊紀錄冊內及已提交文件中的錯誤**  
**Correction of errors in register and in filed documents under sections 67 and 76 of the Registered Designs Ordinance**

下列在 21.05.2021 官方公報刊登的更正錯誤的請求已在 22.07.2021 獲准許

The following request for correction of error advertised in the official journal on 13.09.2019 was allowed on 14.11.2019

[11] 2016581.3M002

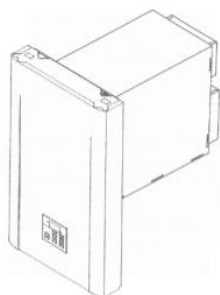



香港特別行政區政府知識產權署外觀設計註冊處

The Government of the Hong Kong Special Administrative Region

Designs Registry, Intellectual Property Department

## 根據註冊外觀設計條例第 76 條，更正已提交文件中的錯誤

### **Correction of errors in filed documents under section 76 of the Registered Designs Ordinance**

下列在 18.06.2021 官方公報刊登的更正錯誤的請求已在 19.08.2021 獲准許

The following request for correction of error advertised in the official journal on 18.06.2021 was allowed on 19.08.2021

[21] 1915154.3

[30] 30.05.2019 / US / 29/693,104