

香港知識產權公報

Hong Kong Intellectual Property Journal

2022年2月11日
11 February 2022

目錄 Contents

根據註冊外觀設計條例第 25 條註冊的外觀設計

Designs Registered under section 25 of the Registered Designs Ordinance

按註冊編號排列

Arranged by Registration Number

根據註冊外觀設計條例(第 522 章)公布的其他公告

Other Notices Published under the Registered Designs Ordinance (Cap. 522)

根據註冊外觀設計條例第 28 條，註冊外觀設計因未繳續期費而停止有效

Registered designs ceased through non-payment of renewal fees under section 28 of the Registered Designs Ordinance

根據註冊外觀設計規則第 31 條刪除的註冊外觀設計

Registered designs removed under section 31 of the Registered Designs Rules

以下事項沒有記錄

No Records for the Following Matters

根據註冊外觀設計條例第 30 條放棄的外觀設計的註冊

Surrender of Registration of Design under section 30 of the Registered Designs Ordinance

根據註冊外觀設計規則第 37 條，向處長作出轉介

Reference to Registrar under section 37 of the Registered Designs Rules

根據註冊外觀設計條例第 45 條，撤銷註冊

Revocation of Registration under section 45 of the Registered Designs Ordinance

根據註冊外觀設計規則第 46 條，向法院作出轉介

Reference to Court under section 46 of the Registered Designs Rules

根據註冊外觀設計規則第 63 條對不符合規定之處作出糾正

Rectification of Irregularities under section 63 of the Registered Designs Rules

根據註冊外觀設計條例第 66 條，糾正註冊紀錄冊

Rectification of Register under section 66 of the Registered Designs Ordinance

根據註冊外觀設計條例第 67 條 更正註冊紀錄冊內的錯誤

Correction of errors in Register under section 67 of the Registered Designs Ordinance

根據註冊外觀設計條例第 67 及 76 條，更正註冊紀錄冊內及已提交文件中的錯誤

Correction of Errors in Register and in Filed Documents under sections 67 and 76 of the Registered Designs Ordinance

根據註冊外觀設計條例第 76 條，更正已提交文件中的錯誤

Correction of errors in filed documents under section 76 of the Registered Designs Ordinance

勘誤

Corrigendum

註冊外觀設計公告註釋

Notes on advertisements of registration of designs

方括號表示下列資料：

Square brackets indicate the following data：

[11] 註冊編號 Registration number / 聯合王國註冊編號 United Kingdom registration number

[15] 註冊日期 Registration date / 當作註冊日期 Deemed registration date / 聯合王國註冊日期 United Kingdom registration date

[17] 註冊有效期屆滿日期 Expiry date of the period of registration

[22] 提交日期 Filing date / 當作提交日期 Deemed filing date / 聯合王國提交日期 United Kingdom filing date

[30] 聲稱享有的優先權（提交日期 / 巴黎公約國或世界貿易組織成員 / 申請編號） Priority claimed (filing date / Paris Convention country or WTO member / application number)

[51] 國際外觀設計分類號（洛迦諾分類號） International Classification of designs (Locarno Classification)

[54] 物品 Article

[55] 外觀設計的表述 Representation of the design

[62] 分開前的申請編號及提交日期 Application number before division and filing date

[66] 過往註冊的聯繫外觀設計註冊編號 / 日期 Registration No. / Date of Previous Registration for Association

[72] 設計人 Designer

[73] 擁有人姓名和地址 Name and address of the owner

[74] 代理人 Agent / 送達地址 Address for service



香港特別行政區政府知識產權署外觀設計註冊處

The Government of the Hong Kong Special Administrative Region

Designs Registry, Intellectual Property Department

根據註冊外觀設計條例第 25 條註冊的外觀設計

Designs registered under section 25 of the Registered Designs Ordinance

按註冊編號排列

Arranged by Registration Number

- [11] 2119198.4M001
- [15] 21-12-2021
- [30] 25-06-2021 / IT / 402021000001736
- [51] Cl. 2-04
- [54] 鞋
Shoe
- [73] VALENTINO S.p.A.
Via Turati, 16/18,
I-20121 Milano,
Italy
- [74] BARRON & YOUNG INTELLECTUAL PROPERTY LIMITED
Suite 617, Lakeside 2,
No. 10 Science Park West Avenue,
Hong Kong Science Park,
Shatin, N.T., Hong Kong

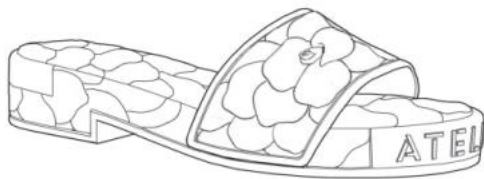

-
- [11] 2119198.4M002
 - [15] 21-12-2021
 - [30] 25-06-2021 / IT / 402021000001736
 - [51] Cl. 2-04
 - [54] 鞋
Shoe
 - [73] VALENTINO S.p.A.
Via Turati, 16/18,

I-20121 Milano,
Italy

[74] BARRON & YOUNG INTELLECTUAL PROPERTY LIMITED
Suite 617, Lakeside 2,
No. 10 Science Park West Avenue,
Hong Kong Science Park,
Shatin, N.T., Hong Kong



[11] 2119199.6M001

[15] 21-12-2021

[30] 16-07-2021 / AM, AZ, BZ, BA, GE, LI, MK, MD, MC, MN, ME, MA,
OM, SG, CH, TN, TR, UA, GB, EU, AL, KG / DM/215 729

[51] Cl. 10-07

[54] 錶殼連錶帶

Watch case with bracelet

[73] Harry Winston SA

Chemin du Tourbillon 8,
CH-1228 Plan-les-Ouates,
Switzerland

[74] SPRUSON & FERGUSON (HONG KONG) LIMITED

5001 Hopewell Centre,
183 Queen's Road East,
Wan Chai, Hong Kong



[11] 2119199.6M002

[15] 21-12-2021

[30] 16-07-2021 / AM, AZ, BZ, BA, GE, LI, MK, MD, MC, MN, ME, MA,
OM, SG, CH, TN, TR, UA, GB, EU, AL, KG / DM/215 729

[51] Cl. 10-07

[54] 錶面
Dial

[73] Harry Winston SA
Chemin du Tourbillon 8,
CH-1228 Plan-les-Ouates,
Switzerland

[74] SPRUSON & FERGUSON (HONG KONG) LIMITED
5001 Hopewell Centre,
183 Queen's Road East,
Wan Chai, Hong Kong

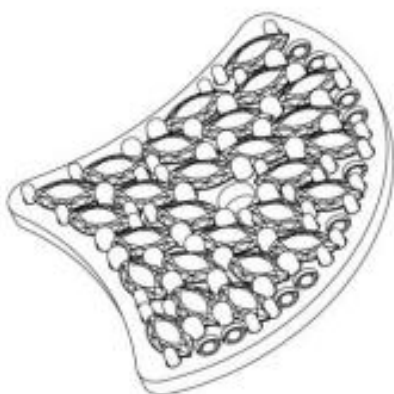

- [11] 2119200.0M001
[15] 21-12-2021
[30] 25-06-2021 / IT / 402021000001739
[51] Cl. 3-01
[54] 袋
Bag
[73] VALENTINO S.p.A.
Via Turati, 16/18,
I-20121 Milano,
Italy
[74] BARRON & YOUNG INTELLECTUAL PROPERTY LIMITED
Suite 617, Lakeside 2,
No. 10 Science Park West Avenue,
Hong Kong Science Park,
Shatin, N.T., Hong Kong



-
- [11] 2119200.0M002
[15] 21-12-2021
[30] 25-06-2021 / IT / 402021000001739
[51] Cl. 3-01
[54] 袋
Bag
[73] VALENTINO S.p.A.
Via Turati, 16/18,
I-20121 Milano,
Italy
[74] BARRON & YOUNG INTELLECTUAL PROPERTY LIMITED
Suite 617, Lakeside 2,
No. 10 Science Park West Avenue,

Hong Kong Science Park,
Shatin, N.T., Hong Kong



[11] 2119201.2

[15] 21-12-2021

[30] 07-07-2021 / MC, RU, SG, CH, GB, US, EU, JP, KR / WIPO106531

[51] Cl. 11-02

[54] 玻璃製品

Glass article

[73] COMPAGNIE DES CRISTALLERIES DE SAINT-LOUIS Société par actions
simplifiée

F-57620 Saint-Louis Les Bitche,
France

[74] DEACONS

5th Floor, Alexandra House,
Central,
Hong Kong



[11] 2119202.4M001

- [15] 22-12-2021
- [30] 26-06-2021 / CN / 202130399743.1
- [51] Cl. 14-02
- [54] 筆記本電腦
Notebook computer
- [73] 榮耀終端有限公司
HONOR DEVICE CO., LTD.
中國內地
廣東省深圳市福田區香蜜湖街道紅荔西路 8089 號
深業中城 6 號樓 A 單元 3401
- [74] 集佳知識產權有限公司
香港九龍
旺角洗衣街 39-55 號
金雞廣場 12 層 1201 室



-
- [11] 2119202.4M002
 - [15] 22-12-2021
 - [30] 26-06-2021 / CN / 202130399743.1
 - [51] Cl. 14-02
 - [54] 筆記本電腦
Notebook computer
 - [73] 榮耀終端有限公司
HONOR DEVICE CO., LTD.
中國內地
廣東省深圳市福田區香蜜湖街道紅荔西路 8089 號
深業中城 6 號樓 A 單元 3401
 - [74] 集佳知識產權有限公司
香港九龍
旺角洗衣街 39-55 號
金雞廣場 12 層 1201 室



- [11] 2119202.4M003
[15] 22-12-2021
[30] 26-06-2021 / CN / 202130399743.1
[51] Cl. 14-02
[54] 筆記本電腦
Notebook computer
[73] 榮耀終端有限公司
HONOR DEVICE CO., LTD.
中國內地
廣東省深圳市福田區香蜜湖街道紅荔西路 8089 號
深業中城 6 號樓 A 單元 3401
[74] 集佳知識產權有限公司
香港九龍
旺角洗衣街 39-55 號
金雞廣場 12 層 1201 室



- [11] 2119202.4M004
[15] 22-12-2021
[30] 26-06-2021 / CN / 202130399743.1
[51] Cl. 14-02
[54] 筆記本電腦
Notebook computer
[73] 榮耀終端有限公司
HONOR DEVICE CO., LTD.
中國內地
廣東省深圳市福田區香蜜湖街道紅荔西路 8089 號
深業中城 6 號樓 A 單元 3401
[74] 集佳知識產權有限公司
香港九龍
旺角洗衣街 39-55 號
金雞廣場 12 層 1201 室



-
- [11] 2119202.4M005
[15] 22-12-2021
[30] 26-06-2021 / CN / 202130399743.1
[51] Cl. 14-02
[54] 筆記本電腦
Notebook computer
[73] 榮耀終端有限公司
HONOR DEVICE CO., LTD.
中國內地
廣東省深圳市福田區香蜜湖街道紅荔西路 8089 號
深業中城 6 號樓 A 單元 3401
[74] 集佳知識產權有限公司
香港九龍
旺角洗衣街 39-55 號
金雞廣場 12 層 1201 室

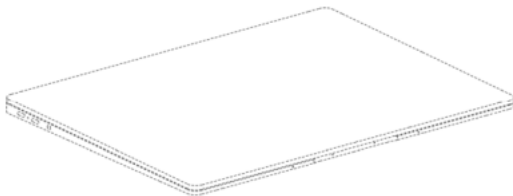

-
- [11] 2119202.4M006
[15] 22-12-2021
[30] 26-06-2021 / CN / 202130399743.1
[51] Cl. 14-02
[54] 筆記本電腦
Notebook computer
[73] 榮耀終端有限公司
HONOR DEVICE CO., LTD.
中國內地
廣東省深圳市福田區香蜜湖街道紅荔西路 8089 號
深業中城 6 號樓 A 單元 3401

- [74] 集佳知識產權有限公司
香港九龍
旺角洗衣街 39-55 號
金雞廣場 12 層 1201 室

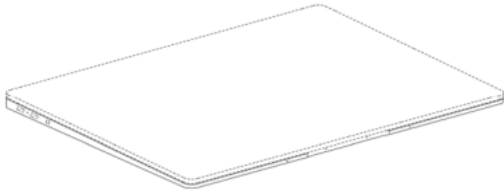

-
- [11] 2119202.4M007
[15] 22-12-2021
[30] 26-06-2021 / CN / 202130399743.1
[51] C1. 14-02
[54] 筆記本電腦
Notebook computer
[73] 榮耀終端有限公司
HONOR DEVICE CO., LTD.
中國內地
廣東省深圳市福田區香蜜湖街道紅荔西路 8089 號
深業中城 6 號樓 A 單元 3401
[74] 集佳知識產權有限公司
香港九龍
旺角洗衣街 39-55 號
金雞廣場 12 層 1201 室

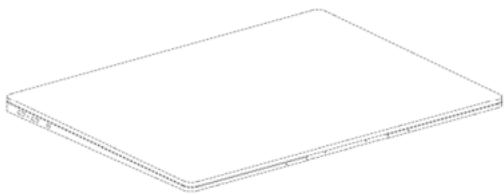

-
- [11] 2119202.4M008
[15] 22-12-2021
[30] 26-06-2021 / CN / 202130399743.1
[51] C1. 14-02
[54] 筆記本電腦
Notebook computer
[73] 榮耀終端有限公司
HONOR DEVICE CO., LTD.

中國內地

廣東省深圳市福田區香蜜湖街道紅荔西路 8089 號

深業中城 6 號樓 A 單元 3401

[74] 集佳知識產權有限公司

香港九龍

旺角洗衣街 39-55 號

金雞廣場 12 層 1201 室

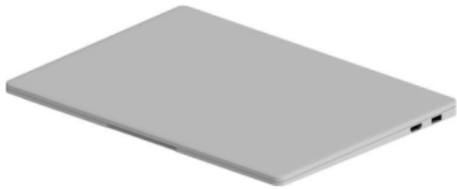

[11] 2119207.5

[15] 22-12-2021

[51] Cl. 1-01

[54] 蛋糕

Cake

[73] 李靜瑤

Lee Ching Yiu

香港

上水顯峯 9C

[74] 卓遠知識產權有限公司

香港上環

禧利街 27 號

富輝商業中心 10 樓



- [11] 2119208.7
[15] 22-12-2021
[51] Cl. 29-02
[54] 透明硅膠防護口罩
Transparent silicone protective mask
[73] 深圳市康利保科技有限公司
中國內地
深圳市龍崗區吉華街道
甘坑社區甘李二路1號
鴻利達廠A棟201
[74] 香港知識產權代理有限公司
香港新界
白石角香港科學園第三期
科技大道西12號2樓230室



-
- [11] 2119209.9
[15] 22-12-2021
[51] Cl. 25-02
[54] 聚乙烯膠板
PE board
[73] SUN EVER CORPORATION LIMITED
2 Tung Mau Square,
Tai Po Market,
Tai Po, N.T., Hong Kong
[74] HONG KONG INTELLECTUAL PROPERTY AGENT LIMITED
Unit 230, 2/F, Building 12W,
No. 12 Science Park West Avenue,
Phase 3, Hong Kong Science Park,
Pak Shek Kok, N.T., Hong Kong



[11] 2119210.1

[15] 22-12-2021

[51] Cl. 21-01

[54] 模型車

Model vehicle

[73] KABUSHIKI KAISHA TAMIYA (TAMIYA, INC.)

3-7, Ondawara,

Shizuoka-City, 422-8610,

Japan

[74] GLOBAL ZEN IP SERVICES LIMITED

Room 1707, 17th Floor Beverly House,

93-107 Lockhart Road,

Wanchai, Hong Kong

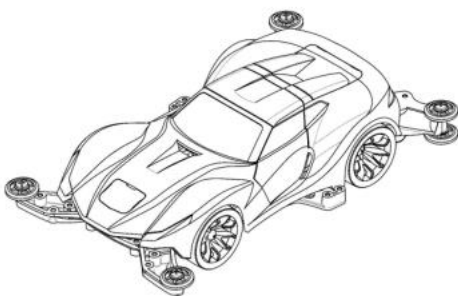

[11] 2119211.3

[15] 22-12-2021

[51] Cl. 29-02

[54] 口罩

Mask

[73] 救世香港有限公司
SAVEWO HONG KONG LIMITED
1/F, 266-270 Texaco Road,
Tsuen Wan, N.T.,
Hong Kong

[74] ACCOLADE IP LIMITED
10/F, Fu Fai Comm. Ctr.,
27 Hillier Street,
Sheung Wan, Hong Kong



[11] 2119212.5M001

[15] 22-12-2021

[30] 05-07-2021 / EU / 008 600 530

[51] Cl. 11-01

[54] 珠寶
Jewellery

[73] FRED PARIS
29 rue des Pyramides,
75001 Paris,
France

[74] LETTERS & THOO LIMITED
Suite 1008, Prosperity Millennia Plaza,
663 King's Road,
Quarry Bay, Hong Kong

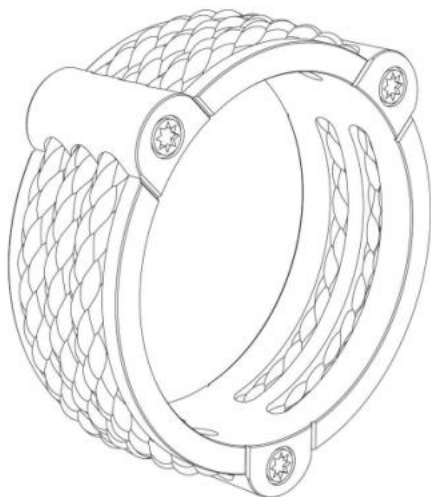

[11] 2119212.5M002

[15] 22-12-2021

[30] 05-07-2021 / EU / 008 600 530

[51] Cl. 11-01

[54] 珠寶

Jewellery

[73] FRED PARIS

29 rue des Pyramides,

75001 Paris,

France

[74] LETTERS & THOO LIMITED

Suite 1008, Prosperity Millennia Plaza,

663 King's Road,

Quarry Bay, Hong Kong

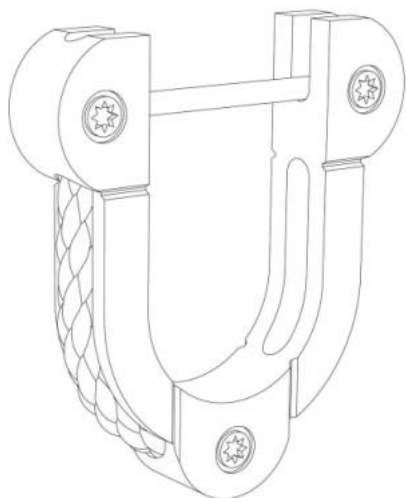

- [11] 2119212.5M003
[15] 22-12-2021
[30] 05-07-2021 / EU / 008 600 530
[51] Cl. 11-01
[54] 珠寶
Jewellery
[73] FRED PARIS
29 rue des Pyramides,
75001 Paris,
France
[74] LETTERS & THOO LIMITED
Suite 1008, Prosperity Millennia Plaza,
663 King's Road,
Quarry Bay, Hong Kong

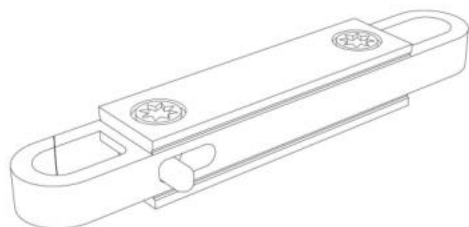

-
- [11] 2119212.5M004
[15] 22-12-2021
[30] 05-07-2021 / EU / 008 600 530
[51] Cl. 11-01
[54] 珠寶
Jewellery
[73] FRED PARIS
29 rue des Pyramides,
75001 Paris,
France
[74] LETTERS & THOO LIMITED
Suite 1008, Prosperity Millennia Plaza,
663 King's Road,
Quarry Bay, Hong Kong

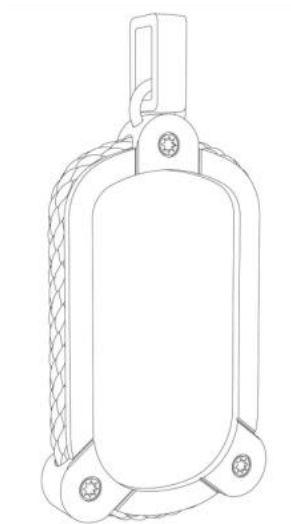

[11] 2119212.5M005

[15] 22-12-2021

[30] 05-07-2021 / EU / 008 600 530

[51] Cl. 11-01

[54] 珠寶

Jewellery

[73] FRED PARIS

29 rue des Pyramides,

75001 Paris,

France

[74] LETTERS & THOO LIMITED

Suite 1008, Prosperity Millennia Plaza,

663 King's Road,

Quarry Bay, Hong Kong

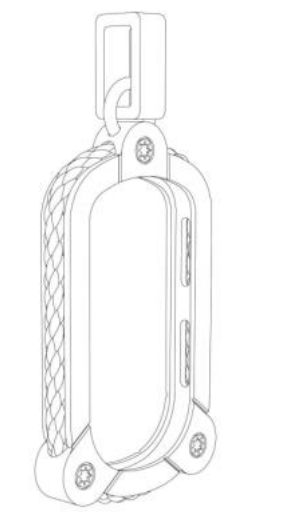

[11] 2119212.5M006

[15] 22-12-2021

[30] 05-07-2021 / EU / 008 600 530

[51] Cl. 11-01

[54] 珠寶

Jewellery

[73] FRED PARIS

29 rue des Pyramides,

75001 Paris,

France

[74] LETTERS & THOO LIMITED

Suite 1008, Prosperity Millennia Plaza,

663 King's Road,

Quarry Bay, Hong Kong

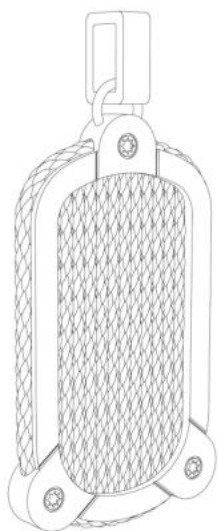

[11] 2119212.5M007

[15] 22-12-2021

[30] 05-07-2021 / EU / 008 600 530

[51] Cl. 11-01

[54] 珠寶

Jewellery

[73] FRED PARIS

29 rue des Pyramides,

75001 Paris,

France

[74] LETTERS & THOO LIMITED

Suite 1008, Prosperity Millennia Plaza,

663 King's Road,

Quarry Bay, Hong Kong

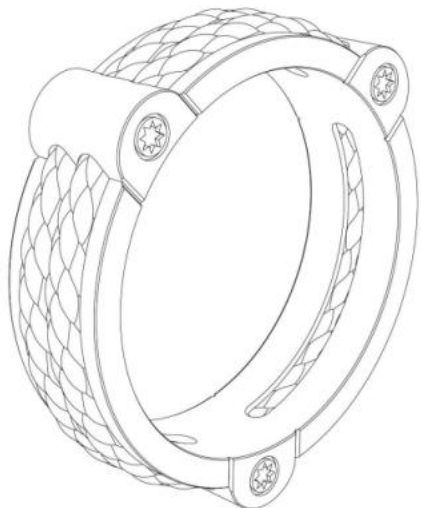

[11] 2119213.7

[15] 22-12-2021

[51] Cl. 7-02

[54] 火爐用燃燒器
Stove burner

[73] Rinnai Kabushiki Kaisha (Rinnai Corporation)
2-26, Fukuzumi-cho, Nakagawa-ku, Nagoya-shi,
Aichi-ken 454-0802,
Japan

[74] MINTERELLISON LLP
Level 32, Wu Chung House,
213 Queen's Road East,
Hong Kong

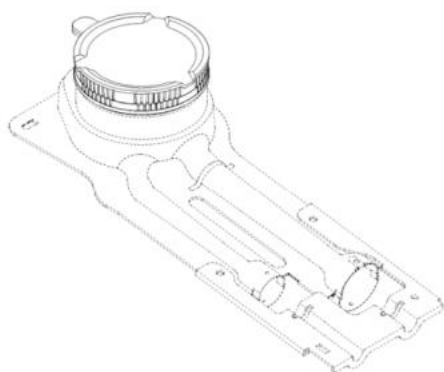

[11] 2119223.8

[15] 28-12-2021

[51] Cl. 4-02

[54] 牙刷

Toothbrush

[73] 好維股份有限公司

Hawley & Hazel (BVI) Co. Ltd.
Trident Chambers, P. O. Box 146,
Road Town, Tortola,
Virgin Islands, British

[74] BAKER & MCKENZIE

14th Floor, One Taikoo Place,
979 King's Road,
Quarry Bay, Hong Kong



[11] 2119224.0

[15] 28-12-2021

[51] Cl. 4-02

[54] 牙刷

Toothbrush

[73] 好維股份有限公司

Hawley & Hazel (BVI) Co. Ltd.
Trident Chambers, P. O. Box 146,
Road Town, Tortola,
Virgin Islands, British

[74] BAKER & MCKENZIE

14th Floor, One Taikoo Place,
979 King's Road,
Quarry Bay, Hong Kong



-
- [11] 2119226.5
[15] 28-12-2021
[30] 05-07-2021 / JP / 014591 of 2021
[51] Cl. 28-03
[54] 捲髮棒
Hair curler
[73] 株式會社 MTG
MTG Co., Ltd.
32, Honjin-Dori 2-Chome,
Nakamura-Ku, Nagoya-Shi,
Aichi-Ken 453-0041,
Japan
[74] CHINAHONGKONG IP LIMITED
1502, 15/F, Capital Centre,
151 Gloucester Road,
Wanchai, Hong Kong

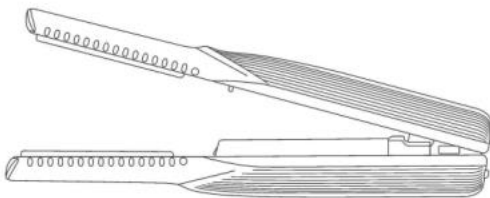

-
- [11] 2119228.9
[15] 28-12-2021
[51] Cl. 11-01

[54] 吊墜

Pendant

[73] 周生生珠寶金行有限公司

Chow Sang Sang Jewellery Company Limited

4/F., Chow Sang Sang Building,

229 Nathan Road,

Kowloon, Hong Kong

[74] HONG KONG INTELLECTUAL PROPERTY AGENT LIMITED

Unit 230, 2/F, Building 12W,

No. 12 Science Park West Avenue,

Phase 3, Hong Kong Science Park,

Pak Shek Kok, N.T., Hong Kong

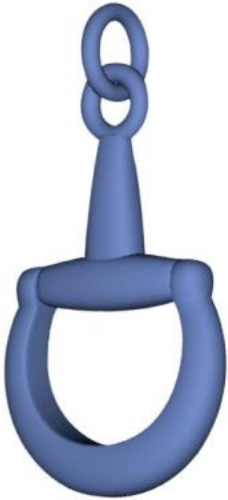

[11] 2119229.1

[15] 28-12-2021

[51] Cl. 11-01

[54] 戒指

Ring

[73] 周生生珠寶金行有限公司

Chow Sang Sang Jewellery Company Limited

4/F., Chow Sang Sang Building,

229 Nathan Road,

Kowloon, Hong Kong

[74] HONG KONG INTELLECTUAL PROPERTY AGENT LIMITED

Unit 230, 2/F, Building 12W,

No. 12 Science Park West Avenue,

Phase 3, Hong Kong Science Park,

Pak Shek Kok, N.T., Hong Kong



[11] 2119230.3

[15] 28-12-2021

[51] Cl. 9-01

[54] 酒瓶

Wine bottle

[73] 百益國際投資集團控股有限公司

B&Y International Investment Holding Company Limited

香港新界

大圍美田邨

美麗樓 30 樓 3003 室

[74] 卓遠知識產權有限公司

香港上環

禧利街 27 號

富輝商業中心 10 樓



- [11] 2119233.9
[15] 29-12-2021
[30] 26-11-2021 / CN / 202130781291.3
[51] Cl. 14-02
[54] 支付機
Payment machine
[73] 上海商湯智能科技有限公司
SHANGHAI SENSETIME INTELLIGENT TECHNOLOGY CO., LTD.
中國內地
上海市徐匯區桂平路 391 號
3 號樓 1605A 室
[74] 香港派特恩知識產權代理有限公司
香港上環
永樂街 121-125 號
永達商業大廈 10 樓 C 室



-
- [11] 2119234.1M001
[15] 29-12-2021
[30] 03-12-2021 / CN / 202130801067.6
[51] Cl. 14-01
[54] 耳機
Headphone
[73] 深圳市韶音科技有限公司
Shenzhen Shokz Co., Ltd.
中國內地
廣東省深圳市寶安區石岩街道浪心社區石新社區
山城工業區 26 棟廠房一層至四層

- [74] 中港知識產權有限公司
香港灣仔
告士打道 151 號
資本中心 15 樓 1502 室



[11] 2119234.1M002

[15] 29-12-2021

[30] 12-10-2021 / CN / 202130669610.1
29-06-2021 / CN / 202130403569.3

[51] Cl. 14-01

[54] 耳機
Headphone

[73] 深圳市韶音科技有限公司
Shenzhen Shokz Co., Ltd.
中國內地
廣東省深圳市寶安區石岩街道浪心社區石新社區
山城工業區 26 棟廠房一層至四層

[74] 中港知識產權有限公司
香港灣仔
告士打道 151 號
資本中心 15 樓 1502 室

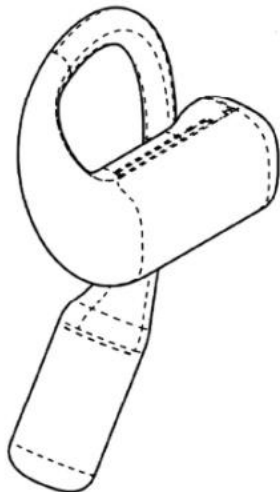

[11] 2119237.8

[15] 29-12-2021

[51] Cl. 6-01

[54] 椅子
Chair

[73] 株式會社 MTG
MTG Co., Ltd.
32, Honjin-Dori 2-Chome,
Nakamura-Ku, Nagoya-Shi,
Aichi-Ken 453-0041,
Japan

[74] CHINAHONGKONG IP LIMITED
1502, 15/F, Capital Centre,
151 Gloucester Road,
Wanchai, Hong Kong



[11] 2119239.2M001

[15] 29-12-2021

[51] Cl. 21-01

[54] 積木

Building block

[73] 佳樂專有限公司

KALOS BLOCKS COMPANY LIMITED

9/F., Southeast Industrial Building,

611-619 Castle Peak Road,

Tsuen Wan, Hong Kong

[74] HONG KONG INTELLECTUAL PROPERTY ADVISORY SERVICE LIMITED

1/F., Fuk Wo Industrial Building,

5 Sheung Hei Street,

San Po Kong, Kowloon, Hong Kong

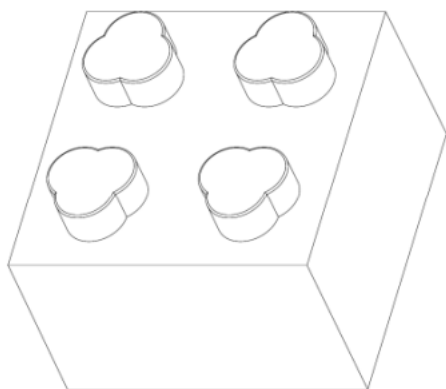

[11] 2119239.2M002

[15] 29-12-2021

[51] Cl. 21-01

[54] 積木

Building block

[73] 佳樂專有限公司

KALOS BLOCKS COMPANY LIMITED

9/F., Southeast Industrial Building,

611-619 Castle Peak Road,

Tsuen Wan, Hong Kong

[74] HONG KONG INTELLECTUAL PROPERTY ADVISORY SERVICE LIMITED

1/F., Fuk Wo Industrial Building,

5 Sheung Hei Street,

San Po Kong, Kowloon, Hong Kong

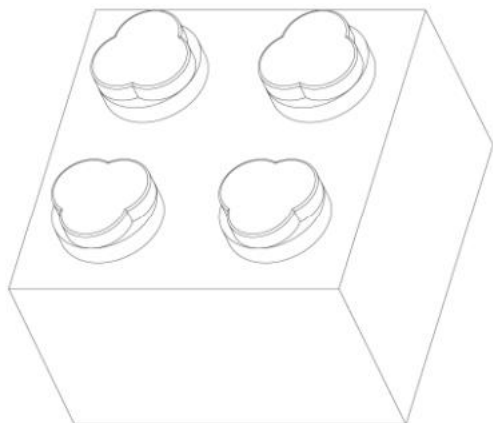

[11] 2119239.2M003

[15] 29-12-2021

[51] Cl. 21-01

[54] 積木

Building block

[73] 佳樂專有限公司

KALOS BLOCKS COMPANY LIMITED

9/F., Southeast Industrial Building,

611-619 Castle Peak Road,

Tsuen Wan, Hong Kong

[74] HONG KONG INTELLECTUAL PROPERTY ADVISORY SERVICE LIMITED

1/F., Fuk Wo Industrial Building,

5 Sheung Hei Street,

San Po Kong, Kowloon, Hong Kong

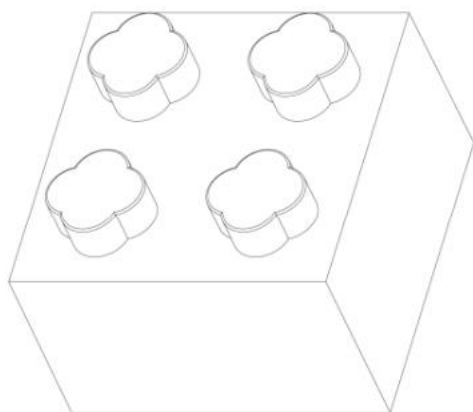

[11] 2119239.2M004

[15] 29-12-2021

[51] Cl. 21-01

[54] 積木

Building block

[73] 佳樂專有限公司

KALOS BLOCKS COMPANY LIMITED

9/F., Southeast Industrial Building,

611-619 Castle Peak Road,

Tsuen Wan, Hong Kong

[74] HONG KONG INTELLECTUAL PROPERTY ADVISORY SERVICE LIMITED

1/F., Fuk Wo Industrial Building,

5 Sheung Hei Street,

San Po Kong, Kowloon, Hong Kong

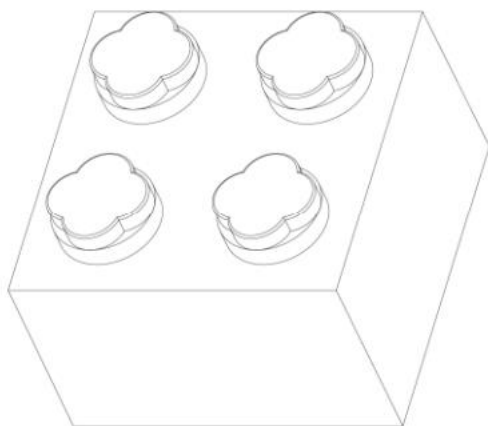

[11] 2119239.2M005

[15] 29-12-2021

[51] Cl. 21-01

[54] 積木

Building block

[73] 佳樂專有限公司

KALOS BLOCKS COMPANY LIMITED

9/F., Southeast Industrial Building,

611-619 Castle Peak Road,

Tsuen Wan, Hong Kong

[74] HONG KONG INTELLECTUAL PROPERTY ADVISORY SERVICE LIMITED

1/F., Fuk Wo Industrial Building,

5 Sheung Hei Street,

San Po Kong, Kowloon, Hong Kong

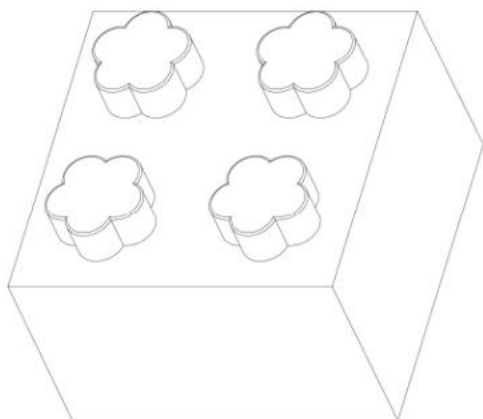

[11] 2119239.2M006

[15] 29-12-2021

[51] Cl. 21-01

[54] 積木

Building block

[73] 佳樂專有限公司

KALOS BLOCKS COMPANY LIMITED

9/F., Southeast Industrial Building,

611-619 Castle Peak Road,

Tsuen Wan, Hong Kong

[74] HONG KONG INTELLECTUAL PROPERTY ADVISORY SERVICE LIMITED

1/F., Fuk Wo Industrial Building,

5 Sheung Hei Street,

San Po Kong, Kowloon, Hong Kong

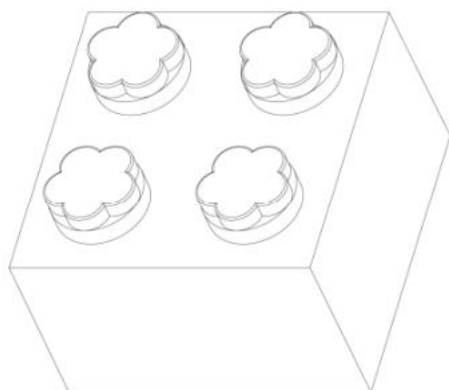

[11] 2119239.2M007

[15] 29-12-2021

[51] Cl. 21-01

[54] 積木

Building block

[73] 佳樂專有限公司

KALOS BLOCKS COMPANY LIMITED

9/F., Southeast Industrial Building,

611-619 Castle Peak Road,

Tsuen Wan, Hong Kong

[74] HONG KONG INTELLECTUAL PROPERTY ADVISORY SERVICE LIMITED

1/F., Fuk Wo Industrial Building,

5 Sheung Hei Street,

San Po Kong, Kowloon, Hong Kong

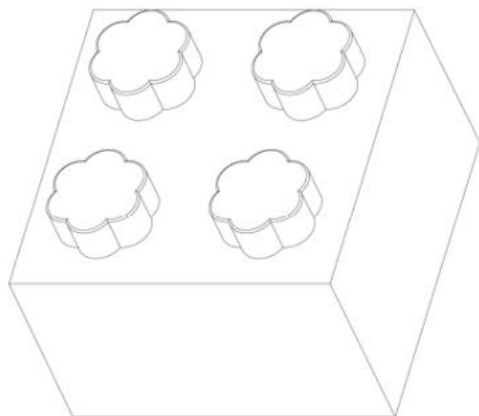

[11] 2119239.2M008

[15] 29-12-2021

[51] Cl. 21-01

[54] 積木

Building block

[73] 佳樂專有限公司

KALOS BLOCKS COMPANY LIMITED

9/F., Southeast Industrial Building,

611-619 Castle Peak Road,

Tsuen Wan, Hong Kong

[74] HONG KONG INTELLECTUAL PROPERTY ADVISORY SERVICE LIMITED

1/F., Fuk Wo Industrial Building,

5 Sheung Hei Street,

San Po Kong, Kowloon, Hong Kong

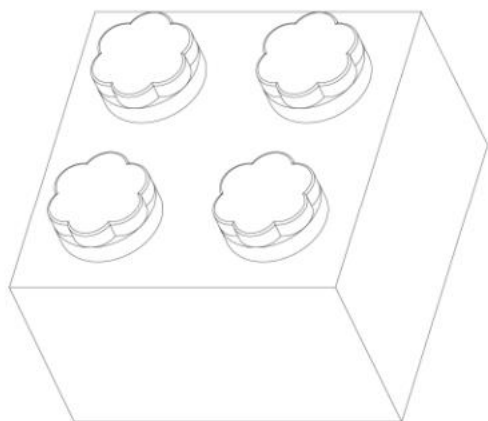

[11] 2119239.2M009

[15] 29-12-2021

[51] Cl. 21-01

[54] 積木

Building block

[73] 佳樂專有限公司

KALOS BLOCKS COMPANY LIMITED

9/F., Southeast Industrial Building,

611-619 Castle Peak Road,

Tsuen Wan, Hong Kong

[74] HONG KONG INTELLECTUAL PROPERTY ADVISORY SERVICE LIMITED

1/F., Fuk Wo Industrial Building,

5 Sheung Hei Street,

San Po Kong, Kowloon, Hong Kong

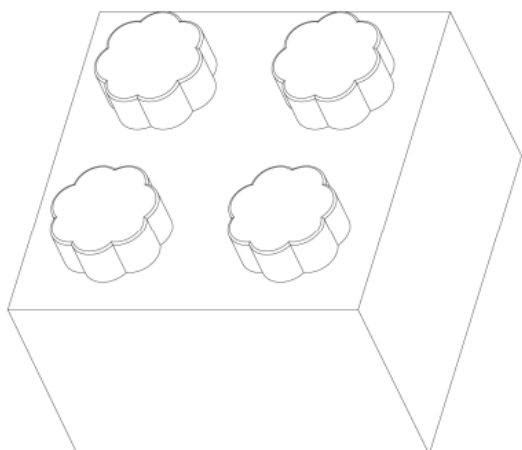

[11] 2119239.2M010

[15] 29-12-2021

[51] Cl. 21-01

[54] 積木

Building block

[73] 佳樂專有限公司

KALOS BLOCKS COMPANY LIMITED

9/F., Southeast Industrial Building,

611-619 Castle Peak Road,

Tsuen Wan, Hong Kong

[74] HONG KONG INTELLECTUAL PROPERTY ADVISORY SERVICE LIMITED

1/F., Fuk Wo Industrial Building,

5 Sheung Hei Street,

San Po Kong, Kowloon, Hong Kong

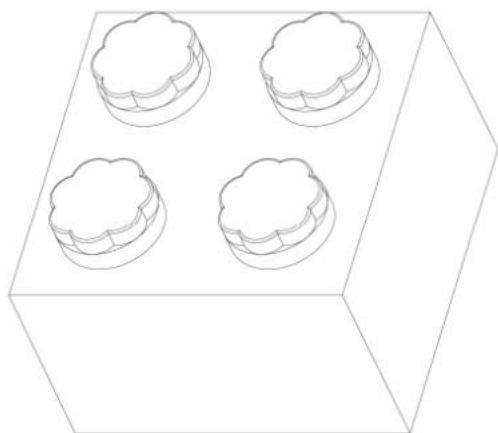

[11] 2119239.2M011

[15] 29-12-2021

[51] Cl. 21-01

[54] 積木

Building block

[73] 佳樂專有限公司

KALOS BLOCKS COMPANY LIMITED

9/F., Southeast Industrial Building,

611-619 Castle Peak Road,

Tsuen Wan, Hong Kong

[74] HONG KONG INTELLECTUAL PROPERTY ADVISORY SERVICE LIMITED

1/F., Fuk Wo Industrial Building,

5 Sheung Hei Street,

San Po Kong, Kowloon, Hong Kong

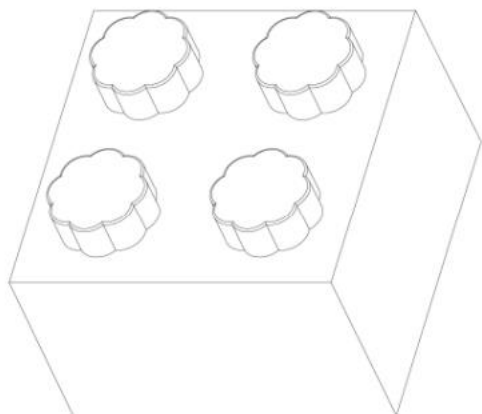

[11] 2119239.2M012

[15] 29-12-2021

[51] Cl. 21-01

[54] 積木

Building block

[73] 佳樂專有限公司

KALOS BLOCKS COMPANY LIMITED

9/F., Southeast Industrial Building,

611-619 Castle Peak Road,

Tsuen Wan, Hong Kong

[74] HONG KONG INTELLECTUAL PROPERTY ADVISORY SERVICE LIMITED

1/F., Fuk Wo Industrial Building,

5 Sheung Hei Street,

San Po Kong, Kowloon, Hong Kong

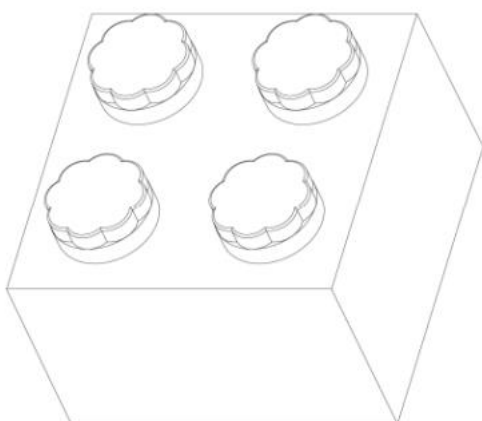



香港特別行政區政府知識產權署外觀設計註冊處

The Government of the Hong Kong Special Administrative Region

Designs Registry, Intellectual Property Department

根據註冊外觀設計條例第 28 條，下列註冊外觀設計因未繳續期費而停止有效。

各組記項按註冊外觀設計停止有效日期及註冊編號先後次序排列。

Registered designs ceased through non-payment of renewal fees under section 28 of the Registered Designs Ordinance. Entries are listed below under their expiry dates.

14-01-2022 - 19-01-2022

14-01-2022	1700071.8M005	1200105.7
0210049.7	1700071.8M006	1700085.8
0700108.6M002	1700071.8M007	1700086.0M001
0700108.6M003	1700072.0	1700086.0M002
0700108.6M004	1700075.7	1700086.0M003
0700108.6M005	1700076.9	
0700108.6M007		19-01-2022
0700108.6M018	17-01-2022	1200118.4
0700109.8	0700133.8	1700099.7
0700110.0M001	1200089.1M001	1700102.5
0700110.0M002	1200089.1M002	1700105.2
0700110.0M003	1200097.8	1700112.6
0700110.0M004	1200098.0M001	1700114.0M002
0700111.2M001	1200101.8	1700115.3
0700111.2M002	1700080.7	
	1700084.5M001	
15-01-2022	1700084.5M002	
1200071.3M001		
1200071.3M002	18-01-2022	
1200071.3M003	0700137.7M001	
1200074.9	0700137.7M002	
1700052.8	0700158.1	
1700054.2M001	0700159.3	
1700054.2M002	0700160.5	
1700054.2M003	0700162.9	
1700056.7	0700163.1M001	
	0700163.1M003	
16-01-2022	0700163.1M004	
0700122.5	0700163.1M005	
1200081.4M001	0700179.5	
1700071.8M001	0700182.1	
1700071.8M002	0700183.3	
1700071.8M003	0700184.5	
1700071.8M004	1200104.4	



香港特別行政區政府知識產權署外觀設計註冊處

The Government of the Hong Kong Special Administrative Region

Designs Registry, Intellectual Property Department

根據註冊外觀設計規則第 31 條刪除的註冊外觀設計。各組記項按註冊外觀設計刪除日期及註冊編號先後次序排列。

Registered designs removed under section 31 of the Registered Designs Rules. Entries are listed below under their removal dates.

21-01-2022 - 27-01-2022**21-01-2022**

0601849.7
1601344.7
1601346.2
1601347.4M001
1601347.4M003
1601347.4M004
1601351.2M002
1601352.4
1601354.8
1601359.9
1601361.3
1601362.5
1601363.7
1601364.9M001
1601364.9M002
1601365.2

22-01-2022

1101209.7
1101211.1
1601367.6M002
1601367.6M003
1601367.6M005
1601367.6M006
1601370.2
1601374.0
1601375.3
1601377.7
1601378.9

23-01-2022

1101212.3M001
1101212.3M002

24-01-2022

0601865.1
0601869.9
0601871.3

25-01-2022

1101219.8
1101220.0
1601379.1M001
1601379.1M002
1601380.3M001
1601380.3M002
1601381.5M001
1601382.7
1601387.8

26-01-2022

1101221.2
1101222.4
1601388.0

27-01-2022

1601390.4M001
1601390.4M002
1601393.0
1601394.2
1601395.5M001
1601395.5M002
1601395.5M003
1601395.5M004
1601395.5M005



香港特別行政區政府知識產權署外觀設計註冊處

The Government of the Hong Kong Special Administrative Region

Designs Registry, Intellectual Property Department

根據註冊外觀設計條例第 76 條，更正已提交文件中的錯誤

Correction of errors in filed documents under section 76 of the Registered Designs Ordinance

下列在 19.11.2021 官方公報刊登的更正錯誤的請求已在 20.01.2022 獲准許

The following request for correction of error advertised in the official journal on 19.11.2021 was allowed on 20.01.2022

[21] 2118492.6

[71] KOWA Inc.

[21] 2118493.8

[71] KOWA Inc.