



香港特別行政區政府知識產權署商標註冊處
Trade Marks Registry, Intellectual Property Department
The Government of the Hong Kong Special Administrative Region

接納註冊 (全文本)

商標註冊處處長已根據《商標條例》(第 559 章)第 42 條, 接納下列商標的註冊申請。現根據《商標條例》第 43 條及《商標規則》(第 559 章附屬法例)第 15 條, 公布申請的詳情。

根據《商標條例》第 44 條及《商標規則》第 16 條, 任何人擬就下列商標的註冊提出反對, 須在本公告公布日期起計的三個月內, 採用表格第 T6 號提交反對通知。(例如, 若果公布日期為 2003 年 4 月 4 日, 則該三個月的後一日為 2003 年 7 月 3 日。)反對通知須載有反對理由的陳述及《商標規則》第 16(2)條所提述的事宜。反對人須在提交反對通知的同時, 將該通知的副本送交有關申請人。

有關商標註冊處處長根據商標條例(第 43 章)第 13 條/商標條例(第 559 章)附表 5 第 10 條所接納的註冊申請, 請到 <http://www.gld.gov.hk/cgi-bin/gld/egazette/index.cgi?lang=c&agree=0> 檢視電子憲報。

ACCEPTANCE FOR REGISTRATION (FULL VERSION)

The Registrar of Trade Marks has accepted the following trade marks for registration under section 42 of the Trade Marks Ordinance (Cap. 559). Under section 43 of the Trade Marks Ordinance and rule 15 of the Trade Marks Rules (Cap. 559 sub. leg.), the particulars of the applications are published.

Under section 44 of the Trade Marks Ordinance and rule 16 of the Trade Marks Rules, any person who wishes to oppose the registration of any of these marks shall, within the 3-month period beginning on the date of this publication, file a notice of opposition on Form T6. (For example, if the publication date is 4 April 2003, the last day of the 3-month period is 3 July 2003.) The notice of opposition shall include a statement of the grounds of opposition and the matters referred to in rule 16(2). The opponent shall, at the same time as he files the notice of opposition, send a copy of it to the applicant of the application in question.

For applications for registration accepted by the Registrar of Trade Marks under section 13 of the Trade Marks Ordinance (Cap. 43)/section 10 of Schedule 5 to the Trade Marks Ordinance (Cap. 559), please view e-gazette at <http://www.gld.gov.hk/cgi-bin/gld/egazette/index.cgi?lang=c&agree=0>.

類別 Class 41

[210] 商標申請編號: 304834486
Application No.:

[540] 商標 :
Mark: **PATTERN**

[550] 商標種類 : Ordinary
Mark Type:
一系列商標 : NO
Series Mark:

[571] 商標描述 : N/A
Mark Description:

[730] 註冊申請人的姓名 / 名稱、地址 :
Applicant(s) ' PATTERN INC.
Name,Address: 1633 W INNOVATION WAY STE 300
LEHI, UTAH 84043
UNITED STATES OF AMERICA

[740/ 註冊申請人的送達地址 :
750] Applicant's Address for DORSEY & WHITNEY
Service: SUITE 3008, ONE PACIFIC PLACE
88 QUEENSWAY
HONG KONG

[511] 類別編號 : 35,41,42
Class(es) No(s) .:

[511] 貨品 / 服務說明 :
Specification: Class 41:
(A) Product photography for business services;
(B) photography; providing on-line videos, not
downloadable; providing on-line music, not
downloadable; educational services;
organization of competitions [education or
entertainment]; lending libraries; layout
services, other than for advertising purposes;
providing on-line electronic publications, not
downloadable; distribution of video tapes;
entertainment information; conducting fitness
classes; toy rental; games equipment rental;
conducting guided tours; animal training;
modeling for artists; organization of
lotteries; rental of indoor aquaria.

[526] 卸棄 : N/A
Disclaimer:

[529] 限制 : N/A
Limitation:

[527] 條件 : N/A
Condition:

其他 : N/A
Others

[220] 提交日期 : 20-02-2019
Date of Filing:

[320] 聲稱具有優先權的日期 : 14-11-2018
Date of Priority Claimed:

[310] 優先權申請編號 : 88194208
Priority Application Number:

[340] 聲稱具有優先權 (部分) : For services listed in (A) in Classes 35, 41
Priority Claim Details: and 42

[330] 優先權申請的 UNITED STATES OF AMERICA

國家、地區、地方：

Country, territory, area of
Priority Applications:

[210] 商標申請編號： 305085144
Application No.:

[540] 商標：
Mark:

SEEK

[550] 商標種類： Ordinary
Mark Type:
一系列商標： NO
Series Mark:

[571] 商標描述： N/A
Mark Description:

[730] 註冊申請人的姓名 / 名稱、地址： Seek Limited
Applicant(s) ' 541 St Kilda Road
Name, Address: Melbourne Victoria 3004
AUSTRALIA

[740/ 註冊申請人的送達地址： SO KEUNG YIP & SIN
750] Applicant's Address for Room 1009-1012, 10/F., Nan Fung Tower,
Service: No. 173 Des Voeux Road Central
HONG KONG

[511] 類別編號： 9, 16, 35, 36, 37, 38, 41, 42, 45
Class(es) No(s) .:

[511] 貨品 / 服務說明： Class 41:
Specification: Education; providing of training;
entertainment; sporting and cultural
activities; publishing of reviews; education
reviews; training reviews; provision of
education and training via global computer
network and via schools and educational
institutions; arranging and conducting of
educational and training workshops; vocational
guidance services in this class (education and
training); provision of vocational guidance
services in this class, including by a
telephone service; provision of advice and
information regarding educational services,
including educational services provided by
others, including via the Internet, databases
and call centres; career advisory services in
this class; career counselling services in
this class; career information and advisory
services in this class; consultancy,
information and advisory services regarding
the aforementioned services

[526]	卸棄:	N/A
	Disclaimer:	
[529]	限制:	N/A
	Limitation:	
[527]	條件:	N/A
	Condition:	
	其他:	By consent, No. 304489868
	Others	
[220]	提交日期:	16-10-2019
	Date of Filing:	
[320]	聲稱具有優先權的日期:	N/A
	Date of Priority Claimed:	
[310]	優先權申請編號:	N/A
	Priority Application Number:	
[340]	聲稱具有優先權 (部分):	N/A
	Priority Claim Details:	
[330]	優先權申請的	N/A
	國家、地區、地方:	
	Country, territory, area of	
	Priority Applications:	
<hr/>		
[210]	商標申請編號:	305085153
	Application No.:	
[540]	商標:	
	Mark:	
		
[550]	商標種類:	Ordinary
	Mark Type:	
	一系列商標:	NO
	Series Mark:	
[571]	商標描述:	N/A
	Mark Description:	
[730]	註冊申請人的姓名 / 名稱、地址:	Seek Limited
	Applicant(s) ' Name, Address:	541 St Kilda Road Melbourne Victoria 3004 AUSTRALIA
[740/750]	註冊申請人的送達地址:	SO KEUNG YIP & SIN
	Applicant's Address for Service:	Room 1009-1012, 10/F., Nan Fung Tower, No. 173 Des Voeux Road Central HONG KONG
[511]	類別編號:	9, 16, 35, 36, 37, 38, 41, 42, 45
	Class(es) No(s) .:	

[511] 貨品 / 服務說明 : Specification:	Class 41: Education; providing of training; entertainment; sporting and cultural activities; publishing of reviews; education reviews; training reviews; provision of education and training via global computer network and via schools and educational institutions; arranging and conducting of educational and training workshops; vocational guidance services in this class (education and training); provision of vocational guidance services in this class, including by a telephone service; provision of advice and information regarding educational services, including educational services provided by others, including via the Internet, databases and call centres; career advisory services in this class; career counselling services in this class; career information and advisory services in this class; consultancy, information and advisory services regarding the aforementioned services
[526] 卸棄 : Disclaimer:	N/A
[529] 限制 : Limitation:	N/A
[527] 條件 : Condition: 其他 : Others	N/A By consent, No. 304489868
[220] 提交日期 : Date of Filing:	16-10-2019
[320] 聲稱具有優先權的日期 : Date of Priority Claimed:	N/A
[310] 優先權申請編號 : Priority Application Number:	N/A
[340] 聲稱具有優先權 (部分) : Priority Claim Details:	N/A
[330] 優先權申請的 國家、地區、地方 : Country, territory, area of Priority Applications:	N/A

[210] 商標申請編號 : 305208444
Application No.:

[540] 商標 :

Mark:



[550] 商標種類 :

Ordinary

Mark Type:

一系列商標 :

NO

Series Mark:

[571] 商標描述 :

Mark Description:

The mark consists of a 3-dimensional shape of a building façade with the letter, numeral and word "K11 MUSEA" appearing on it. The applicant claims the shape of the configuration of a building façade as an element of the trade mark.

[730] 註冊申請人的姓名 / 名稱、地址 :

Applicant(s) ' Name,Address:

NEW WORLD DEVELOPMENT COMPANY LIMITED
30th Floor, New World Tower,
18 Queen's Road Central,
HONG KONG

[740/ 註冊申請人的送達地址 :

750] Applicant's Address for Service:

HOGAN LOVELLS
11th Floor, One Pacific Place
88 Queensway
HONG KONG

[511] 類別編號 :

Class(es) No(s) .:

35, 36, 41, 43

[511] 貨品 / 服務說明 :

Specification:

Class 41:
Education; providing of training; entertainment; sporting and cultural activities; arranging and conducting conferences and conventions; arranging and conducting of workshops; arranging professional workshop and training courses; art exhibition and gallery services; art gallery services relating to fine arts leasing; booking of tickets for entertainment activities; charitable services, namely academic mentoring, education or training; club services [entertainment or education]; conducting classes, seminars, and workshops in the fields of art, graphic and industrial design, healthcare, wellness, cooking, cuisine and food art; non-financial sponsorship of sporting competition and entertainment and of cultural events; on-line ticket reservation services for entertainment events; organisation of entertainment services including art exhibitions, sport, music, cultural and recreational events and competitions; organising charitable

fundraising events being the provision of entertainment, sporting and cultural services; organising of art exhibitions; organization and arranging of musical events and other cultural and artistic events; presentation of works of visual art or literature to the public for cultural or educational purposes; providing club recreation facilities; art gallery services; conducting lectures relating to art and movie; conducting workshops and seminars in art and movie appreciation; education services related to the arts; organization and arranging of artistic events; organizing and conducting of sports and cultural activities; organizing cultural and arts events; organizing of art exhibitions; provision of education, recreation, instruction, tuition and training both interactive and non-interactive; provision of entertainment, cultural or sporting event activities and booking or reservation services of entertainment, cultural or sporting event activities provided in relation to a loyalty program or incentive scheme; information, advisory and consultancy services relating to the aforesaid services.

[526] 卸棄 : N/A

Disclaimer:

[529] 限制 : N/A

Limitation:

[527] 條件 : N/A

Condition:

其他 :

Others

By consent, Nos. 303599768, 304180725, 304405112, 304587904 and 304670668.

[220] 提交日期 : 04-03-2020

Date of Filing:

[320] 聲稱具有優先權的日期 : N/A

Date of Priority Claimed:

[310] 優先權申請編號 : N/A

Priority Application Number:

[340] 聲稱具有優先權 (部分) : N/A

Priority Claim Details:

[330] 優先權申請的 : N/A

國家、地區、地方 :

Country, territory, area of

Priority Applications:

[210] 商標申請編號 : 305261706

Application No.:

[540] 商標：
Mark:



[550] 商標種類： 一般商標
Mark Type:
一系列商標： 否
Series Mark:

[571] 商標描述： 不適用
Mark Description:

[730] 註冊申請人的姓名 / 名稱、地址： 三七互娛（上海）科技有限公司
Applicant(s) ' 中國
Name, Address: 上海市嘉定區
南翔鎮銀翔路 655 號 809 室

[740/ 註冊申請人的送達地址： 標準香港企業註冊服務有限公司
750] Applicant's Address for 香港
Service: 九龍旺角彌敦道 678 號
華僑商業中心 15C

[511] 類別編號： 9, 41
Class(es) No(s) .:

[511] 貨品 / 服務說明： 類別 41：
Specification: 娛樂信息；提供不可下載在線視頻；遊戲器具出租；在計算機
網絡上提供在線遊戲；組織教育或娛樂競賽；組織體育比賽；
組織角色扮演娛樂活動；提供不可下載的在線電子出版物；除
廣告片外的影片製作；娛樂服務。

[526] 卸棄： 不適用
Disclaimer:

[529] 限制： 不適用
Limitation:

[527] 條件： 不適用
Condition:
其他： 不適用
Others

[220] 提交日期： 30-04-2020
Date of Filing:

[320] 聲稱具有優先權的日期： 不適用
Date of Priority Claimed:

[310] 優先權申請編號： 不適用
Priority Application Number:

[340] 聲稱具有優先權（部分）： 不適用
Priority Claim Details:

[330] 優先權申請的 不適用
國家、地區、地方：
Country, territory, area of
Priority Applications:

[210] 商標申請編號 : 305376105

Application No.:

[540] 商標 :

Mark:



[550] 商標種類 : Ordinary

Mark Type:

一系列商標 :

NO

Series Mark:

[571] 商標描述 : N/A

Mark Description:

[730] 註冊申請人的姓名 / 名稱、地址 :

Applicant(s)'

Name,Address:

Spin Digital Media, LLC
662 N. Sepulveda Blvd.,
Suite 300, Los Angeles,
California 90049, U.S.A.

[740/ 註冊申請人的送達地址 :

750] Applicant's Address for
Service:

Ronald Tong & Co
Room 501, 5/F., Sun Hung Kai Centre
30 Harbour Road
HONG KONG

[511] 類別編號 : 41

Class(es) No(s) .:

[511] 貨品 / 服務說明 :

Specification:

Class 41:
Entertainment in the nature of an ongoing series featuring topics in music, lifestyle, pop culture and celebrities, news, and entertainment, provided through television broadcasts, cable television, and the Internet; streaming podcasts/vodcasts in the fields of music, lifestyle, pop culture and celebrities, news, and entertainment; entertainment services including providing podcasts/vodcasts; entertainment services, namely, providing multimedia content featuring topics in music, lifestyle, pop culture and celebrities, news, and entertainment via various platforms across multiple forms of transmission media, the Internet, and digital networks; entertainment services, namely,

providing a web site portal featuring links to musical performances, musical videos, related film clips, photographs, and other multimedia entertainment materials; providing non-downloadable pre-recorded music and non-downloadable audio, and video musical presentations via global computer networks, mobile telephones, and other digital communication networks and wireless devices; entertainment services in the nature of the production and distribution of a television series; organizing and producing musical events and concerts; providing a web site portal featuring links to musical artist websites and music performance ticket information; providing temporary use of online non-downloadable computer software, namely, providing interactive multimedia computer software games; providing temporary use of online non-downloadable computer software for playing games with others over a global computer network; all excluding the fields of physical fitness and/or exercise (in particular table tennis and/or table tennis facilities).

[526]	卸棄 : Disclaimer:	N/A
[529]	限制 : Limitation:	N/A
[527]	條件 : Condition:	N/A
	其他 : Others	N/A
[220]	提交日期 : Date of Filing:	31-08-2020
[320]	聲稱具有優先權的日期 : Date of Priority Claimed:	26-03-2020
[310]	優先權申請編號 : Priority Application Number:	88/848,815
[340]	聲稱具有優先權 (部分) : Priority Claim Details:	N/A
[330]	優先權申請的 國家、地區、地方 : Country, territory, area of Priority Applications:	UNITED STATES OF AMERICA

[210]	商標申請編號 : Application No.:	305453992
-------	------------------------------	-----------

[540]	商標 : Mark:			
[550]	商標種類 : Mark Type:	一般商標		
	一系列商標 : Series Mark:	否		
[571]	商標描述 : Mark Description:	不適用		
[730]	註冊申請人的姓名/名稱、地址 : Applicant(s) ' Name, Address:	阿拉梅達研究有限責任公司 (ALAMEDA RESEARCH LLC) 美國 加利福尼亞州 伯克利中心街 2000 號 400 室, 郵編 94704		
[740/750]	註冊申請人的送達地址 : Applicant's Address for Service:	DEACONS 5th Floor, Alexandra House Central HONG KONG		
[511]	類別編號 : Class(es) No(s) .:	9, 35, 36, 41, 42		
[511]	貨品/服務說明 : Specification:	類別 41: (A) 培訓; 安排和組織會議; 流動圖書館; 電子書籍和雜誌的在 線出版; 提供不可下載的在線電子出版物; 文字出版 (廣告宣傳 文本除外); 通過計算機網絡在線提供的遊戲服務。(B) 教育 服務。		
[526]	卸棄 : Disclaimer:	不適用		
[529]	限制 : Limitation:	不適用		
[527]	條件 : Condition:	不適用		
	其他 : Others	不適用		
[220]	提交日期 : Date of Filing:	19-11-2020		
[320]	聲稱具有優先權的日期 : Date of Priority Claimed:	[310] 優先權申請編號 : Priority Application No.:	[340] 聲稱具有優先權 (部分) : Priority Claim Details:	[330] 優先權申請的 國家、地區、地方 : Country, territory, area of Priority Applications:
28-05-2020	46751586	適用於類別 9 內 (A) 項貨品		中國
28-05-2020	46725736	適用於類別 35 內 (A) 項服 務		中國

28-05-2020	46732302	適用於類別 36 內 (A) 項服務	中國
28-05-2020	46733784	適用於類別 41 內 (A) 項服務	中國
28-05-2020	46759885	適用於類別 42 內 (A) 項服務	中國

[210] 商標申請編號 :	305454009
Application No.:	
[540] 商標 :	
Mark:	
[550] 商標種類 :	一般商標
Mark Type:	
一系列商標 :	否
Series Mark:	
[571] 商標描述 :	不適用
Mark Description:	
[730] 註冊申請人的姓名/名稱、地址 :	阿拉梅達研究有限責任公司 (ALAMEDA RESEARCH LLC)
Applicant(s) ' Name, Address:	美國 加利福尼亞州 伯克利中心街 2000 號 400 室, 郵編 94704
[740/ 註冊申請人的送達地址 :	DEACONS
750] Applicant's Address for Service:	5th Floor, Alexandra House Central HONG KONG
[511] 類別編號 :	9, 35, 36, 41, 42
Class(es) No(s) .:	
[511] 貨品/服務說明 :	類別 41:
Specification:	(A) 培訓; 安排和組織會議; 流動圖書館; 電子書籍和雜誌的在線出版; 提供不可下載的在線電子出版物; 文字出版 (廣告宣傳文本除外); 通過計算機網絡在線提供的遊戲服務。(B) 教育服務。
[526] 卸棄 :	不適用
Disclaimer:	
[529] 限制 :	不適用
Limitation:	
[527] 條件 :	不適用
Condition:	
其他 :	不適用
Others	

[220] 提交日期: 19-11-2020

Date of Filing:

[320]	[310]	[340]	[330]
聲稱具有優先權的日期:	優先權申請編號:	聲稱具有優先權 (部分):	優先權申請的
Date of Priority	Priority Application	Priority Claim	國家、地區、地方:
Claimed:	No.:	Details:	Country, territory,
			area of Priority
			Applications:

28-05-2020 46759648 適用於類別 9 內 (A) 項貨品 中國

28-05-2020 46750650 適用於類別 35 內 (A) 項服
務 中國28-05-2020 46729087 適用於類別 36 內 (A) 項服
務 中國28-05-2020 46736855 適用於類別 41 內 (A) 項服
務 中國28-05-2020 46732326 適用於類別 42 內 (A) 項服
務 中國

[210] 商標申請編號: 305590945

Application No.:

[540] 商標:

Mark:

GROUND TRUTH

[550] 商標種類: Ordinary

Mark Type:

一系列商標:

NO

Series Mark:

[571] 商標描述: N/A

Mark Description:

[730] 註冊申請人的姓名 / 名稱、地址:

Applicant (s)'

Name, Address:

Argo AI, LLC
2545 Railroad Street,
Pittsburgh, Pennsylvania 15222,
UNITED STATES OF AMERICA

[740/ 註冊申請人的送達地址:

750] Applicant's Address for
Service:WILKINSON & GRIST
6th Floor, Prince's Building
Chater Road, Central
HONG KONG

[511] 類別編號 : 41
Class(es) No(s) :
[511] 貨品 / 服務說明 : Class 41:
Specification: On-line journals, namely, blogs featuring
autonomous vehicle technology.

[526] 卸棄 : N/A
Disclaimer:
[529] 限制 : N/A
Limitation:
[527] 條件 : N/A
Condition:
其他 : N/A
Others

[220] 提交日期 : 13-04-2021
Date of Filing:
[320] 聲稱具有優先權的日期 : 15-10-2020
Date of Priority Claimed:
[310] 優先權申請編號 : 90257093
Priority Application Number:
[340] 聲稱具有優先權 (部分) : N/A
Priority Claim Details:
[330] 優先權申請的 UNITED STATES OF AMERICA
國家、地區、地方 :
Country, territory, area of
Priority Applications:

[210] 商標申請編號 : 305592907
Application No.:

[540] 商標 : A PEBBLES
Mark: B Pebbles
C pebbles

D
P
E
B
B
L
E
S

- [550] 商標種類 : Ordinary
Mark Type:
一系列商標 : YES
Series Mark:
- [571] 商標描述 : N/A
Mark Description:
- [730] 註冊申請人的姓名 / 名稱、地址 : Pebbles Limited
Applicant(s) ' Shop A, G/F Commercial Building,
Name,Address: Harbour Place, 8 Oi King Street, Hunghom,
HONG KONG
- [740/ 註冊申請人的送達地址 : SO KEUNG YIP & SIN
750] Applicant's Address for Room 1009-1012, 10/F., Nan Fung Tower,
Service: No. 173 Des Voeux Road Central
HONG KONG
- [511] 類別編號 : 9,16,35,41
Class(es) No(s) .:
- [511] 貨品 / 服務說明 : Class 41:
Specification: Education; teaching and training services;
conducting educational activities such as
courses, seminars and conferences; providing
distance and online learning instruction;
providing information about education;
providing a website featuring non-downloadable
videos in the field of debate, education,
music, public speaking and sports; library
services; design of educational courses and
examinations; personal development training;
volunteer training and development; academies
[education]; educational testing services;
arranging and conducting of ceremonies
relating to the awarding of prizes and
rewards; arranging gala evenings for
educational and entertainment purposes;
presentation of live performances; art and
craft exhibition services; training,
demonstration and instruction services
relating to the use of computers, computer
hardware, computer software and technology;
arranging and conducting of conferences,

colloquiums, symposiums, congresses, seminars, workshops, conventions, concerts and exhibitions for cultural and educational purposes; event management services (organisation of educational, entertainment, sporting or cultural events); career counselling; career advisory services [education or training advice]; computer-based education services; arranging and conducting of educational courses, training workshops and practical training; tutorials, seminars, videos, webinars and workshops on college, university and post-secondary education; conducting training classes relating to computer software and hardware; design of educational courses and examinations; arranging and conducting of educational examinations; educational assessment services; courses relating to research and development; provision of correspondence courses; advisory services relating to education and training provided on-line from a computer database or the Internet; club services; boarding schools; nursery schools; playgroups; publication of texts, books, periodicals, printed matter, photographs, magazines, educational material, instructional materials and teaching materials; publication of educational articles in electronic form; on-line electronic publications (not downloadable); publication of audio or video works; editing of books, audio-visual materials, movies and printed matter; writing of texts; electronic desktop publishing; editing of written texts; editing of sound and images; editing of audio-visual data; distribution of blogs, vlogs, films, audio and video recordings; production, editing, presentation and recording of blogs, vlogs, films, audio and video recordings, images, texts and multimedia works; provision of distance learning courses; production of internet, radio and television programmes; production of films, videos, webinars and digital versatile disks; live performances (presentation of -); music composition services; musical conducting services; news reporters services; orchestra services; writing of texts; providing (publishing) on-line journals, namely, blogs and vlogs; organization of fetes; consulting with parents or guardians on appropriate schools for their children (educational consulting services); consulting with corporations on appropriate schools for their staff (training consulting services); organisation, production and presentation of events for educational,

cultural or philanthropic purposes;
publication of greeting cards by electronic
computer aided means; camp services;
photography; dubbing; translation;
interpretation services; coaching [training];
adult education services; employee training
services; management training services; know-
how transfer [training]; personnel training;
skills training; providing facilities for
training purposes; designing of training
courses; arranging and conducting an awards
program and ceremonies; nursery schools;
psychological examination and career advice
[education advice]; providing non-downloadable
digital music from a global computer network;
providing on-line computer games [not
downloadable]; entertainment; sporting and
cultural activities; consultancy, advisory
services and provision of information relating
to all the foregoing; all included in class
41.

- [526] 卸棄 : N/A
Disclaimer:
- [529] 限制 : N/A
Limitation:
- [527] 條件 : N/A
Condition:
其他 : N/A
Others
- [220] 提交日期 : 15-04-2021
Date of Filing:
- [320] 聲稱具有優先權的日期 : N/A
Date of Priority Claimed:
- [310] 優先權申請編號 : N/A
Priority Application Number:
- [340] 聲稱具有優先權 (部分) : N/A
Priority Claim Details:
- [330] 優先權申請的 : N/A
國家、地區、地方 :
Country, territory, area of
Priority Applications:

-
- [210] 商標申請編號 : 305600349
Application No.:
- [540] 商標 :
Mark:

苏氏研创院

[550] 商標種類: Ordinary
Mark Type:
一系列商標: NO
Series Mark:

[571] 商標描述: N/A
Mark Description:

[730] 註冊申請人的姓名 / 名稱、地址: Chimelong International Investment Company
Applicant(s) ' Limited
Name,Address: Vistra Corporate Services Centre, Wickhams Cay
II
Road Town, Tortola, VG1110
VIRGIN ISLANDS (BRITISH)

[740/ 註冊申請人的送達地址: BENNY KONG & TSAI
750] Applicant's Address for Unit 19B, Overseas Trust Bank Building
Service: No. 160 Gloucester Road, Wanchai
HONG KONG

[511] 類別編號: 39,41,42,43
Class(es) No(s) .:

[511] 貨品 / 服務說明: Class 41:
Specification: Entertainment services; Production of radio
and television programs; providing sports
facilities; instruction services; organising
performances; mobile library services;
publication of books; distribution [other than
transportation] of pre-recorded video-tapes;
toy rental; games equipment rental; conducting
guided tours; zoological garden services;
modelling for artists; organization of
lotteries; rental of indoor aquaria;
organisation of lottery

[526] 卸棄: N/A
Disclaimer:

[529] 限制: N/A
Limitation:

[527] 條件: N/A
Condition:
其他: N/A
Others

[220] 提交日期: 21-04-2021
Date of Filing:

[320] 聲稱具有優先權的日期: N/A
Date of Priority Claimed:

[310] 優先權申請編號: N/A
Priority Application Number:

[340] 聲稱具有優先權 (部分): N/A
Priority Claim Details:

[330] 優先權申請的 N/A
國家、地區、地方:
Country, territory, area of
Priority Applications:

[210]	商標申請編號 : Application No.:	305603698
[540]	商標 : Mark:	百佳荟外贸家
[550]	商標種類 : Mark Type:	一般商標
	一系列商標 : Series Mark:	否
[571]	商標描述 : Mark Description:	不適用
[730]	註冊申請人的姓名 / 名稱、地址 : Applicant (s) ' Name, Address:	杭州百佳薈對外貿易集團有限公司 中國 浙江省杭州市 余杭區倉前街道文一西路 1218 號 35 幢 1 單元 501 室
[740/750]	註冊申請人的送達地址 : Applicant's Address for Service:	中港知識產權有限公司 香港 灣仔告士打道 151 號 資本中心 15 樓 1502 室
[511]	類別編號 : Class(es) No(s) .:	9, 35, 38, 41, 42
[511]	貨品 / 服務說明 : Specification:	類別 41: 提供不可下載的在線電子出版物; 電子書籍和雜誌的在線出版; ; 書籍出版; 通過全球計算機網絡出版電子報紙; 教育; 培訓; ; 就業指導 (教育或培訓顧問); 廣告、推銷、市場營銷和商 業戰略規劃的培訓課程; 安排和組織現場教育論壇; 安排和組 織會議; 組織文化或教育展覽; 流動圖書館; 電視文娛節目; 娛樂服務; 提供不可下載的在線視頻; 通過互聯網方式提供的 電子遊戲服務; 俱樂部服務 (娛樂或教育); 導遊服務。
[526]	卸棄 : Disclaimer:	不適用
[529]	限制 : Limitation:	不適用
[527]	條件 : Condition:	不適用
	其他 : Others	不適用
[220]	提交日期 : Date of Filing:	23-04-2021
[320]	聲稱具有優先權的日期 : Date of Priority Claimed:	不適用
[310]	優先權申請編號 : Priority Application Number:	不適用
[340]	聲稱具有優先權 (部分) : Priority Claim Details:	不適用
[330]	優先權申請的	不適用

國家、地區、地方：

Country, territory, area of
Priority Applications:

[210] 商標申請編號： 305603706
Application No.:

[540] 商標：
Mark:



[550] 商標種類： 一般商標
Mark Type:

一系列商標： 否

Series Mark:

[571] 商標描述： 不適用

Mark Description:

[730] 註冊申請人的姓名 / 名稱、地址：
Applicant(s)'
Name, Address:

杭州百佳荟對外貿易集團有限公司

中國

浙江省杭州市

余杭區倉前街道文一西路 1218 號 35 幢 1 單元 501 室

[740/ 註冊申請人的送達地址：

中港知識產權有限公司

750] Applicant's Address for
Service:

香港

灣仔告士打道 151 號

資本中心 15 樓 1502 室

[511] 類別編號： 9, 35, 38, 41, 42
Class(es) No(s) .:

[511] 貨品 / 服務說明： 類別 41:

Specification:

提供不可下載的在線電子出版物；電子書籍和雜誌的在線出版；書籍出版；通過全球計算機網絡出版電子報紙；教育；培訓；就業指導（教育或培訓顧問）；廣告、推銷、市場營銷和商業戰略規劃的培訓課程；安排和組織現場教育論壇；安排和組織會議；組織文化或教育展覽；流動圖書館；電視文娛節目；娛樂服務；提供不可下載的在線視頻；通過互聯網方式提供的電子遊戲服務；俱樂部服務（娛樂或教育）；導遊服務。

[526] 卸棄： 不適用
Disclaimer:

[529] 限制： 不適用
Limitation:

[527] 條件： 不適用
Condition:

其他： 不適用

Others

[220] 提交日期： 23-04-2021
Date of Filing:

[320] 聲稱具有優先權的日期： 不適用

Date of Priority Claimed:

[310] 優先權申請編號: 不適用

Priority Application Number:

[340] 聲稱具有優先權 (部分): 不適用

Priority Claim Details:

[330] 優先權申請的 不適用

國家、地區、地方:

Country, territory, area of

Priority Applications:

[210] 商標申請編號: 305613543

Application No.:

[540] 商標:

Mark:

LELLOBEE

[550] 商標種類: Ordinary

Mark Type:

一系列商標:

NO

Series Mark:

[571] 商標描述: N/A

Mark Description:

[730] 註冊申請人的姓名 / 名稱、地址:

Moonbug Entertainment Limited

Applicant(s)'

Labs Upper Lock 2nd Floor 3-6 Water Lane

Name, Address:

Camden Town London NW1 8JZ

UNITED KINGDOM

[740/ 註冊申請人的送達地址:

BENNY KONG & TSAI

750] Applicant's Address for

Unit 19B, Overseas Trust Bank Building

Service:

No. 160 Gloucester Road, Wanchai

HONG KONG

[511] 類別編號: 3, 5, 8, 9, 10, 11, 12, 14, 15, 16, 18, 20, 21, 24, 25, 26, 27

Class(es) No(s) .:

, 28, 29, 30, 32, 35, 41, 42, 43

[511] 貨品 / 服務說明:

Class 41:

Specification:

Education; providing of training;
entertainment; sporting and cultural
activities; children's entertainment services;
providing, arranging and/or organising games;
online interactive entertainment; online game
services; video production; video library
services; video entertainment services;
production and/or provision of television
programmes, movies, animated cartoons, videos,
live performances, storytelling events;
production of entertainment shows and
interactive programs for distribution via
television, cable, satellite, audio and video
media, cartridges, laser discs, computer discs
and electronic means; presentation of live
performances; animation production; television

scheduling (programming); providing entertainment and education via website featuring interactive educational games, animated cartoons, videos and literature that promote character development in children; providing online non-downloadable e-books that promote character development in children; publishing services; digital video, audio and multimedia entertainment publishing services; publishing of activity and puzzle books; publishing of printed matter; publishing of newsletters; magazine publishing; issue of publications; publishing of electronic books; publication services; amusement park services; providing recreation facilities; providing amusement arcade services; presentation of circus performances; presentation of variety shows; theatre productions; production of shows; holiday camp services [entertainment]; organisation of shows [impresario services]; entertainment services featuring fictional characters; theme parks; adventure playground services; soft play centres; fun park services; information, consultancy and advisory services relating to all the aforesaid services.

- [526] 卸棄 : N/A
Disclaimer:
- [529] 限制 : N/A
Limitation:
- [527] 條件 : N/A
Condition:
其他 : N/A
Others
- [220] 提交日期 : 03-05-2021
Date of Filing:
- [320] 聲稱具有優先權的日期 : N/A
Date of Priority Claimed:
- [310] 優先權申請編號 : N/A
Priority Application Number:
- [340] 聲稱具有優先權 (部分) : N/A
Priority Claim Details:
- [330] 優先權申請的
國家、地區、地方 : N/A
Country, territory, area of
Priority Applications:

-
- [210] 商標申請編號 : 305614524
Application No.:

[540] 商標 : Mark:	A HENDERSON LAND B HENDERSON LAND
[550] 商標種類 : Mark Type:	Ordinary
一系類商標 : Series Mark:	YES
[571] 商標描述 : Mark Description:	N/A
[730] 註冊申請人的姓名 / 名稱、地址 : Applicant(s)' Name, Address:	Henderson Development Limited 72-76/F, Two International Finance Centre, 8 Finance Street, Central, HONG KONG
[740/ 註冊申請人的送達地址 : 750] Applicant's Address for Service:	WOO KWAN LEE & LO Room 2801, Sun Hung Kai Centre, 30 Harbour Road, Wanchai HONG KONG
[511] 類別編號 : Class(es) No(s) .:	35, 36, 37, 41, 43, 44
[511] 貨品 / 服務說明 : Specification:	Class 41: Providing entertainment facilities; providing recreation facilities; provision of swimming pool facilities; theme park services; publication of books, journals, magazines, periodicals and pamphlets; education; providing of training; entertainment; sporting and cultural activities; organizing, arranging and conducting of conferences, symposiums and seminars; arranging and conducting of training workshops; arranging and organizing of group recreation activities; club services (entertainment or education); health club services; electronic games services provided from a computer database or by means of the internet or through the use of a mobile application; all included in Class 41.
[526] 卸棄 : Disclaimer:	N/A
[529] 限制 : Limitation:	N/A
[527] 條件 : Condition:	N/A
其他 : Others	By consent, Nos. 300139464, 303139759, 303682990, 303683007, 303683016, 303683025, 303683034, 303683043, 303683052, 304240773, 305169628, 305169646, 305461164 and 305519386
[220] 提交日期 : Date of Filing:	04-05-2021
[320] 聲稱具有優先權的日期 : Date of Priority Claimed:	N/A
[310] 優先權申請編號 : Priority Application Number:	N/A

[340] 聲稱具有優先權 (部分): N/A
Priority Claim Details:

[330] 優先權申請的 N/A
國家、地區、地方:
Country, territory, area of
Priority Applications:

[210] 商標申請編號: 305614533
Application No.:

[540] 商標: A **HENDERSON LAND**
Mark: **恒基兆業地產**
B **HENDERSON LAND**
恒基兆業地產
C **HENDERSON LAND**
恒基兆業地產
D **HENDERSON LAND**
恒基兆業地產

[550] 商標種類: Ordinary
Mark Type:
一系列商標: YES
Series Mark:

[571] 商標描述: N/A
Mark Description:

[730] 註冊申請人的姓名 / 名稱、地址: Henderson Development Limited
Applicant(s) ' 72-76/F, Two International Finance Centre,
Name, Address: 8 Finance Street, Central,
HONG KONG

[740/ 註冊申請人的送達地址: WOO KWAN LEE & LO
750] Applicant's Address for Room 2801, Sun Hung Kai Centre,
Service: 30 Harbour Road, Wanchai
HONG KONG

[511] 類別編號: 35, 36, 37, 41, 43, 44
Class(es) No(s) .:

[511] 貨品 / 服務說明: Class 41:
Specification: Providing entertainment facilities; providing
recreation facilities; provision of swimming
pool facilities; theme park services;
publication of books, journals, magazines,
periodicals and pamphlets; education;
providing of training; entertainment; sporting
and cultural activities; organizing, arranging
and conducting of conferences, symposiums and

seminars; arranging and conducting of training workshops; arranging and organizing of group recreation activities; club services (entertainment or education); health club services; electronic games services provided from a computer database or by means of the internet or through the use of a mobile application; all included in Class 41.

[526] 卸棄: N/A

Disclaimer:

[529] 限制: N/A

Limitation:

[527] 條件: N/A

Condition:

其他:

Others

By consent, Nos. 300139464, 303139759, 303682990, 303683007, 303683016, 303683025, 303683034, 303683043, 303683052, 304240773, 305169628, 305169637, 305169646, 305169655, 305461164 and 305519386

[220] 提交日期: 04-05-2021

Date of Filing:

[320] 聲稱具有優先權的日期: N/A

Date of Priority Claimed:

[310] 優先權申請編號: N/A

Priority Application Number:

[340] 聲稱具有優先權 (部分): N/A

Priority Claim Details:

[330] 優先權申請的: N/A

國家、地區、地方:

Country, territory, area of

Priority Applications:

[210] 商標申請編號: 305620626

Application No.:

[540] 商標:

Mark:



DIFFERENCE
MAKERS

[550] 商標種類: Ordinary

Mark Type:

一系列商標:

NO

Series Mark:

[571] 商標描述:

Mark Description:

The applicant claims the colours red, blue, dark blue and black as elements of the trade mark.

[730] 註冊申請人的姓名 / 名稱、地址 : Chartered Accountants Australia and New Zealand
Applicant(s) ' 33 Erskine Street,
Name,Address: Sydney, New South Wales 2000,
AUSTRALIA

[740/ 註冊申請人的送達地址 : OLDDHAM LI & NIE SOLICITORS
750] Applicant's Address for 503, St. George's Building,
Service: 2 Ice House Street, Central,
HONG KONG

[511] 類別編號 : 35,41
Class(es) No(s) .:

[511] 貨品 / 服務說明 : Class 41:
Specification: Education, training, and entertainment services; weblog (blog) services (online publication of journals or diaries); arranging and conducting of seminars, conferences, symposiums, workshops and professional development programs; education examination services; vocational guidance; publishing, including electronic publishing; publication of texts; arranging and conducting training; correspondence courses; organisation of competitions for education or entertainment purposes; teaching and tuition services; research, information, advisory and consultancy services in relation to all aforementioned services; provision of all aforementioned services by an organisation for the benefit of its members; provision of all aforementioned services electronically, including via the Internet.

[526] 卸棄 : N/A
Disclaimer:

[529] 限制 : N/A
Limitation:

[527] 條件 : N/A
Condition:

其他 : By consent, No. 305214898.
Others

[220] 提交日期 : 11-05-2021
Date of Filing:

[320] 聲稱具有優先權的日期 : N/A
Date of Priority Claimed:

[310] 優先權申請編號 : N/A
Priority Application Number:

[340] 聲稱具有優先權 (部分) : N/A
Priority Claim Details:

[330] 優先權申請的 N/A
國家、地區、地方 :
Country, territory, area of
Priority Applications:

[210] 商標申請編號 : 305622020
Application No.:

[540] 商標 :
Mark: **CONNECTIVITY STANDARDS
ALLIANCE**

[550] 商標種類 : Ordinary
Mark Type:
一系列商標 : NO
Series Mark:

[571] 商標描述 : N/A
Mark Description:

[730] 註冊申請人的姓名 / 名稱、地址 : Zigbee Alliance
Applicant(s) ' 508 Second Street, Suite 206
Name, Address: Davis, California 95616
UNITED STATES OF AMERICA

[740/ 註冊申請人的送達地址 : DLA PIPER HONG KONG
750] Applicant's Address for 25th Floor, Three Exchange Square,
Service: 8 Connaught Place, Central,
HONG KONG

[511] 類別編號 : 9,35,41,42
Class(es) No(s) .:

[511] 貨品 / 服務說明 : Class 41:
Specification: Educational services, namely, conducting
workshops, conferences, seminars, classes, and
training services in the fields of
interoperability standards and wireless
communication standards.

[526] 卸棄 : N/A
Disclaimer:

[529] 限制 : N/A
Limitation:

[527] 條件 : N/A
Condition:
其他 : N/A
Others

[220] 提交日期 : 12-05-2021
Date of Filing:

[320] 聲稱具有優先權的日期 : 22-03-2021
Date of Priority Claimed:

[310] 優先權申請編號 : 90593533
Priority Application Number:

[340] 聲稱具有優先權 (部分) : N/A
Priority Claim Details:

[330] 優先權申請的
國家、地區、地方 : UNITED STATES OF AMERICA
Country, territory, area of
Priority Applications:

[210] 商標申請編號 : 305623768

Application No.:

[540] 商標 : A

Mark:



B



[550] 商標種類 : Ordinary

Mark Type:

一系列商標 : YES

Series Mark:

[571] 商標描述 : The applicant claims the colours navy blue and white as elements of mark A in the series.

Mark Description:

[730] 註冊申請人的姓名 / 名稱、地址 :

Applicant(s) '

Name,Address:

CliftonLarsonAllen, LLP
Suite 300, 220 South Sixth Street
Minneapolis, MINNESOTA 554021926
UNITED STATES OF AMERICA

[740/ 註冊申請人的送達地址 :

MARKS & CLERK

750] Applicant's Address for

Service:

Level 9, Cyberport 1
100 Cyberport Road, Pok Fu Lam
HONG KONG

[511] 類別編號 :

9, 16, 35, 36, 41, 42, 45

Class(es) No(s) .:

- [511] 貨品 / 服務說明 :
Specification:
- Class 41:
Training in the use and operation of computer hardware and software; education services, namely, conducting courses, seminars, conferences, workshops and classes in the field of accounting, auditing, tax, management consulting, business, financial management and analysis, information technology and online business activities and operations and, developing and distributing educational materials in connection therewith; all included in Class 41.
- [526] 卸棄 :
Disclaimer: N/A
- [529] 限制 :
Limitation: N/A
- [527] 條件 :
Condition: N/A
- 其他 :
Others: N/A
- [220] 提交日期 :
Date of Filing: 13-05-2021
- [320] 聲稱具有優先權的日期 :
Date of Priority Claimed: 13-04-2021
- [310] 優先權申請編號 :
Priority Application Number: 90642163
- [340] 聲稱具有優先權 (部分) :
Priority Claim Details: For mark "A" in the series.
- [330] 優先權申請的
國家、地區、地方 :
Country, territory, area of
Priority Applications: UNITED STATES OF AMERICA

- [210] 商標申請編號 :
Application No.: 305635026

- [540] 商標 :
Mark:



- [550] 商標種類 :
Mark Type: Ordinary

一系列商標 : NO
Series Mark:
[571] 商標描述 : N/A
Mark Description:
[730] 註冊申請人的姓名 / 名稱、地址 : New World Development Company Limited
Applicant(s) ' 30th Floor, New World Tower
Name,Address: 18 Queen's Road Central
HONG KONG
[740/ 註冊申請人的送達地址 : HOGAN LOVELLS
750] Applicant's Address for 11th Floor, One Pacific Place
Service: 88 Queensway
HONG KONG
[511] 類別編號 : 35,41
Class(es) No(s) .:
[511] 貨品 / 服務說明 : Class 41:
Specification: Education; providing of training;
entertainment; sporting and cultural
activities; arranging and conducting
conferences and conventions; arranging and
conducting of workshops; arranging
professional workshop and training courses;
art exhibition and gallery services; art
gallery services relating to fine arts
leasing; booking of tickets for entertainment
activities; charitable services, namely
academic mentoring, education or training;
club services [entertainment or education];
conducting classes, seminars, and workshops in
the fields of art, graphic and industrial
design, healthcare, wellness, cooking, cuisine
and food art; non-financial sponsorship of
sporting competition and entertainment and of
cultural events; on-line ticket reservation
services for entertainment events;
organisation of entertainment services
including art exhibitions, sport, music,
cultural and recreational events and
competitions; organising charitable
fundraising events being the provision of
entertainment, sporting and cultural services;
organising of art exhibitions; organization
and arranging of musical events and other
cultural and artistic events; presentation of
works of visual art or literature to the
public for cultural or educational purposes;
providing club recreation facilities; art
gallery services; conducting lectures relating
to art and movie; conducting workshops and
seminars in art and movie appreciation;
education services related to the arts;
organization and arranging of artistic events;
organizing and conducting of sports and
cultural activities; organizing cultural and
arts events; organizing of art exhibitions;
provision of education, recreation,
instruction, tuition and training both

interactive and non-interactive; provision of entertainment, cultural or sporting event activities and booking or reservation services of entertainment, cultural or sporting event activities provided in relation to a loyalty program or incentive scheme; information, advisory and consultancy services relating to the aforesaid services.

- [526] 卸棄 : N/A
Disclaimer:
- [529] 限制 : N/A
Limitation:
- [527] 條件 : N/A
Condition:
其他 : By consent, Nos. 303599768, 303980412,
Others 303980421, 304180725,
304180815, 304405112, 304456413, 304587904,
304670668, 304975642.
- [220] 提交日期 : 25-05-2021
Date of Filing:
- [320] 聲稱具有優先權的日期 : N/A
Date of Priority Claimed:
- [310] 優先權申請編號 : N/A
Priority Application Number:
- [340] 聲稱具有優先權 (部分) : N/A
Priority Claim Details:
- [330] 優先權申請的 : N/A
國家、地區、地方 :
Country, territory, area of
Priority Applications:
-
-

- [210] 商標申請編號 : 305652739
Application No.:
- [540] 商標 :
Mark:

MEETSOCIAL

- [550] 商標種類 : 一般商標
Mark Type:
一系列商標 : 否
Series Mark:
- [571] 商標描述 : 不適用
Mark Description:

[730] 註冊申請人的姓名 / 名稱、地址 : 飛書深諾數字科技 (上海) 股份有限公司
Applicant (s) ' 中國
Name, Address: 上海市普陀區
中江路 879 弄 28 號樓 4036 室

[740/ 註冊申請人的送達地址 : 柯伍陳律師事務所
750] Applicant's Address for 香港
Service: 中環康樂廣場 8 號
交易廣場第三期 19 樓
9, 35, 36, 38, 41, 42, 45

[511] 類別編號 :
Class (es) No (s) . :
[511] 貨品 / 服務說明 : 類別 41 :
Specification: 教育 ; 培訓 ; 職業再培訓 ; 組織教育或娛樂競賽 ; 安排和組織
培訓班 ; 安排和組織會議 ; 電子書籍和雜誌的在綫出版 ; 提供
不可下載的在綫電子出版物 ; 提供不可下載的在綫視頻 ; 俱樂部
服務 (娛樂或教育) 。

[526] 卸棄 : 不適用
Disclaimer:
[529] 限制 : 不適用
Limitation:
[527] 條件 : 不適用
Condition:
其他 : 不適用
Others

[220] 提交日期 : 09-06-2021
Date of Filing:
[320] 聲稱具有優先權的日期 : 不適用
Date of Priority Claimed:
[310] 優先權申請編號 : 不適用
Priority Application Number:
[340] 聲稱具有優先權 (部分) : 不適用
Priority Claim Details:
[330] 優先權申請的 不適用
國家、地區、地方 :
Country, territory, area of
Priority Applications:

[210] 商標申請編號 : 305657888
Application No.:

[540] 商標 : A
Mark:



B



[550] 商標種類 : Ordinary
Mark Type:
一系列商標 : YES
Series Mark:

[571] 商標描述 : The applicant claims the colour brown as an element of mark "A" in the series.
Mark Description:

[730] 註冊申請人的姓名 / 名稱、地址 : REGISTERED FINANCIAL PLANNING CENTER, INC.
Applicant(s) ' TRADING AS REGISTERED FINANCIAL PLANNERS
Name,Address: INSTITUTE
2001 COOPER FOSTER PARK ROAD,
AMHERST OH 44001
UNITED STATES OF AMERICA





[740/ 註冊申請人的送達地址 : RUBY YEUNG & CO.
750] Applicant's Address for UNIT 701, 7TH FLOOR, WING ON HOUSE
Service: 71 DES VOEUX ROAD CENTRAL
HONG KONG

[511] 類別編號 : 41
Class(es) No(s) .:

[511] 貨品 / 服務說明 : Class 41:
Specification: educational and instructional services in the field of insurance, investment planning, tax planning, financial planning, financial management, retirement planning, banking and mortgage banking, loans and financing, real estate, capital investment, stocks and bonds brokerage services; arranging of conventions for educational and training purposes; education information services; publishing services; provision of aforesaid services from a computer database or via Internet.

[526] 卸棄 : N/A
Disclaimer:

[529] 限制 : N/A
Limitation:

[527] 條件 :	N/A
Condition:	
其他 :	N/A
Others	
[220] 提交日期 :	16-06-2021
Date of Filing:	
[320] 聲稱具有優先權的日期 :	N/A
Date of Priority Claimed:	
[310] 優先權申請編號 :	N/A
Priority Application Number:	
[340] 聲稱具有優先權 (部分) :	N/A
Priority Claim Details:	
[330] 優先權申請的	N/A
國家、地區、地方 :	
Country, territory, area of	
Priority Applications:	
<hr/>	
[210] 商標申請編號 :	305712697
Application No.:	
[540] 商標 :	A  HENDERSON LAND DEVELOPMENT COMPANY LIMITED 恒基兆業地產有限公司
Mark:	B  HENDERSON LAND DEVELOPMENT COMPANY LIMITED 恒基兆業地產有限公司
	C  HENDERSON LAND DEVELOPMENT COMPANY LIMITED 恒基兆業地產有限公司
	D  HENDERSON LAND DEVELOPMENT COMPANY LIMITED 恒基兆業地產有限公司
[550] 商標種類 :	Ordinary
Mark Type:	
一系列商標 :	YES
Series Mark:	
[571] 商標描述 :	N/A
Mark Description:	
[730] 註冊申請人的姓名 / 名稱、地址 :	Henderson Development Limited
Applicant(s) ' Name, Address:	72-76/F, Two International Finance Centre, 8 Finance Street, Central, HONG KONG
[740/ 註冊申請人的送達地址 :	WOO KWAN LEE & LO
750] Applicant's Address for Service:	Room 2801, Sun Hung Kai Centre, 30 Harbour Road, Wanchai HONG KONG
[511] 類別編號 :	35, 36, 37, 41, 43, 44
Class(es) No(s) .:	
[511] 貨品 / 服務說明 :	Class 41:
Specification:	Providing entertainment facilities; providing recreation facilities; provision of swimming pool facilities; theme park services; publication of books, journals, magazines,

periodicals and pamphlets; education; providing of training; entertainment; sporting and cultural activities; organizing, arranging and conducting of conferences, symposiums and seminars; arranging and conducting of training workshops; arranging and organizing of group recreation activities; club services (entertainment or education); health club services; electronic games services provided from a computer database or by means of the internet or through the use of a mobile application; all included in Class 41.

[526] 卸棄: N/A

Disclaimer:

[529] 限制: N/A

Limitation:

[527] 條件: N/A

Condition:

其他:

Others

By consent, Nos. 300139464, 300517743, 303139759, 303682990, 303683007, 303683016, 303683025, 303683034, 303683043, 303683052, 304240773, 305169628, 305169637, 305169646, 305169655, 305461164 and 305519386

[220] 提交日期: 10-08-2021

Date of Filing:

[320] 聲稱具有優先權的日期: N/A

Date of Priority Claimed:

[310] 優先權申請編號: N/A

Priority Application Number:

[340] 聲稱具有優先權 (部分): N/A

Priority Claim Details:

[330] 優先權申請的: N/A

國家、地區、地方:

Country, territory, area of

Priority Applications:

[210] 商標申請編號: 305712705

Application No.:

[540] 商標:

Mark:





- [550] 商標種類 : Ordinary
 Mark Type:
 一系列商標 : YES
 Series Mark:
- [571] 商標描述 : N/A
 Mark Description:
- [730] 註冊申請人的姓名 / 名稱、地址 : Henderson Development Limited
 Applicant(s) ' 72-76/F, Two International Finance Centre,
 Name, Address: 8 Finance Street, Central,
 HONG KONG
- [740/ 註冊申請人的送達地址 : WOO KWAN LEE & LO
 750] Applicant's Address for Room 2801, Sun Hung Kai Centre,
 Service: 30 Harbour Road, Wanchai
 HONG KONG
- [511] 類別編號 : 35, 36, 37, 41, 43, 44
 Class(es) No(s) .:
- [511] 貨品 / 服務說明 : Class 41:
 Specification: Providing entertainment facilities; providing recreation facilities; provision of swimming pool facilities; theme park services; publication of books, journals, magazines, periodicals and pamphlets; education; providing of training; entertainment; sporting and cultural activities; organizing, arranging and conducting of conferences, symposiums and seminars; arranging and conducting of training workshops; arranging and organizing of group recreation activities; club services (entertainment or education); health club services; electronic games services provided from a computer database or by means of the internet or through the use of a mobile application; all included in Class 41.
- [526] 卸棄 : N/A
 Disclaimer:
- [529] 限制 : N/A
 Limitation:
- [527] 條件 : N/A
 Condition:
 其他 : By consent, Nos. 300139464, 300517743,
 Others 303139759, 303682990, 303683007, 303683016,
 303683025, 303683034, 303683043, 303683052,
 304240773, 305169628, 305169637, 305169646,
 305169655, 305461164 and 305519386
- [220] 提交日期 : 10-08-2021
 Date of Filing:
- [320] 聲稱具有優先權的日期 : N/A
 Date of Priority Claimed:
- [310] 優先權申請編號 : N/A
 Priority Application Number:

[340] 聲稱具有優先權 (部分): N/A
Priority Claim Details:

[330] 優先權申請的 N/A
國家、地區、地方:
Country, territory, area of
Priority Applications:

[210] 商標申請編號: 305733171
Application No.:

[540] 商標:
Mark:



[550] 商標種類: Ordinary
Mark Type:
一系列商標: NO
Series Mark:

[571] 商標描述: N/A
Mark Description:

[730] 註冊申請人的姓名 / 名稱、地址: Aston Martin Lagonda Limited
Applicant(s) ' Banbury Road, Gaydon,
Name,Address: Warwick CV35 0DB
UNITED KINGDOM

[740/ 註冊申請人的送達地址: SIMONE INTELLECTUAL PROPERTY SERVICES ASIA
750] Applicant's Address for LIMITED
Service: 25th Floor, 3 Lockhart Road,
Wanchai,
HONG KONG

[511] 類別編號: 3, 6, 7, 8, 9, 12, 14, 16, 18, 20, 21, 24, 25, 27, 28, 33, 34,
Class(es) No(s) .: 35, 36, 37, 39, 40, 41, 42, 43

[511] 貨品 / 服務說明: Class 41:
Specification: Entertainment, sporting and cultural
activities and services; adventure
entertainment; entertainment by way of
providing rides and driving experiences in
vehicles, luxury vehicles, rare vehicles;
automobile racing teams for entertainment,
gaming, sporting purposes; sportscar teams for
entertainment, gaming, sporting purposes;
provision of club-based entertainment,
sporting and cultural activities; automotive
and driver club services; vehicle racing club
services; country club services; fan club
services; sports club services; education,
training, tuition in motor vehicle driving,
motor vehicle care and motor vehicle
maintenance, road safety, driver safety, low-
emission vehicles; racing information
services; racing driver training; organisation

of racing events, racing competitions, motor racing competitions, automobile racing events, vehicle racing events, automobile rallies, automobile tours; car shows, automobile shows; provision of sports and sporting facilities; organisation, production and presentation of competitions, contests and games; video production services; museums, museum exhibitions, curating museums and cultural exhibits and exhibitions; providing entertainment as part of travel, accommodation and holiday packages; hospitality services (entertainment); corporate hospitality services (entertainment); publishing services; publication of printed matter, books, journals, manuals, magazines, newsletters, news and entertainment articles and publications.

- [526] 卸棄 : N/A
Disclaimer:
- [529] 限制 : N/A
Limitation:
- [527] 條件 : N/A
Condition:
其他 : N/A
Others
- [220] 提交日期 : 31-08-2021
Date of Filing:
- [320] 聲稱具有優先權的日期 : 01-03-2021
Date of Priority Claimed:
- [310] 優先權申請編號 : 82787
Priority Application Number:
- [340] 聲稱具有優先權 (部分) : for goods listed in "A" in Classes 9 and 12
Priority Claim Details: and for all goods and services in Classes 3, 6, 7, 8, 14, 16, 18, 20, 21, 24, 25, 27, 28, 33, 34, 35, 36, 37, 39, 40, 41, 42 and 43
- [330] 優先權申請的
國家、地區、地方 : JAMAICA
Country, territory, area of
Priority Applications:

- [210] 商標申請編號 : 305733180
Application No.:

- [540] 商標 :
Mark:



- [550] 商標種類 : Ordinary

Mark Type:

一系列商標 :

NO

Series Mark:

[571] 商標描述 :

N/A

Mark Description:

[730] 註冊申請人的姓名 / 名稱、地址 :

Aston Martin Lagonda Limited

Applicant(s) '

Banbury Road, Gaydon,

Name,Address:

Warwick CV35 0DB

UNITED KINGDOM

[740/ 註冊申請人的送達地址 :

SIMONE INTELLECTUAL PROPERTY SERVICES ASIA

750] Applicant's Address for

LIMITED

Service:

25th Floor, 3 Lockhart Road,

Wanchai,

HONG KONG

[511] 類別編號 :

3, 6, 7, 8, 9, 12, 14, 16, 18, 20, 21, 24, 25, 27, 28, 33, 34,

Class(es) No(s) .:

35, 36, 37, 39, 40, 41, 42, 43

[511] 貨品 / 服務說明 :

Class 41:

Specification:

Entertainment, sporting and cultural activities and services; adventure entertainment; entertainment by way of providing rides and driving experiences in vehicles, luxury vehicles, rare vehicles; automobile racing teams for entertainment, gaming, sporting purposes; sportscar teams for entertainment, gaming, sporting purposes; provision of club-based entertainment, sporting and cultural activities; automotive and driver club services; vehicle racing club services; country club services; fan club services; sports club services; education, training, tuition in motor vehicle driving, motor vehicle care and motor vehicle maintenance, road safety, driver safety, low-emission vehicles; racing information services; racing driver training; organisation of racing events, racing competitions, motor racing competitions, automobile racing events, vehicle racing events, automobile rallies, automobile tours; car shows, automobile shows; provision of sports and sporting facilities; organisation, production and presentation of competitions, contests and games; video production services; museums, museum exhibitions, curating museums and cultural exhibits and exhibitions; providing entertainment as part of travel, accommodation and holiday packages; hospitality services (entertainment); corporate hospitality services (entertainment); publishing services; publication of printed matter, books, journals, manuals, magazines, newsletters, news and entertainment articles and publications.

[526] 卸棄: N/A
Disclaimer:

[529] 限制: N/A
Limitation:

[527] 條件: N/A
Condition:
其他: N/A
Others

[220] 提交日期: 31-08-2021
Date of Filing:

[320] 聲稱具有優先權的日期: 01-03-2021
Date of Priority Claimed:

[310] 優先權申請編號: 82788
Priority Application Number:

[340] 聲稱具有優先權 (部分): for goods listed in "A" in Classes 9 and 12
Priority Claim Details: and for all goods and services in Classes 3,
6, 7, 8, 14, 16, 18, 20, 21, 24, 25, 27, 28,
33, 34, 35, 36, 37, 39, 40, 41, 42 and 43

[330] 優先權申請的
國家、地區、地方: JAMAICA
Country, territory, area of
Priority Applications:

[210] 商標申請編號: 305751586
Application No.:

[540] 商標:
Mark:



majUP

[550] 商標種類: Ordinary
Mark Type:
一系列商標: NO
Series Mark:

[571] 商標描述: The applicant claims the colours blue, white
Mark Description: and turquoise as elements of the trade mark.

[730] 註冊申請人的姓名 / 名稱、地址 : Majorel Berlin GmbH
Applicant(s)' Wohlrabedamm 32
Name,Address: 13629 Berlin
GERMANY

[740/ 註冊申請人的送達地址 : DEACONS
750] Applicant's Address for 5th Floor,
Service: Alexandra House Central
HONG KONG

[511] 類別編號 : 9,35,36,38,39,41,42,43,45
Class(es) No(s) .:

[511] 貨品 / 服務說明 : Class 41:
Specification: Education at academies; Provision of training
services for business; Career counseling
[education]; Calligraphy services; Coaching
[training]; Arranging and conducting of
colloquiums, conferences, congresses,
educational in-person events, workshops,
seminars and symposiums; Organization of
competitions [education or entertainment];
Distance learning; Education; Training;
Instruction; Conducting educational exams;
Demonstration lessons in practical exercises;
Training on simulators; Organization and
implementation of educational in-person
events; Education and training advice; Taking
photos [photography]; Creation of photo
reports; Vocational retraining; Compilation of
radio and television programs; Providing non-
downloadable television broadcasts via video-
on-demand; Translation services; Private
lessons [education]; Recording of video
recordings; Providing non-downloadable films
via video on demand; Publishing of
publications and desktop publishing [creating
publications with computers]; Microfilming;
Montage [editing] of video tapes; Party
planning [entertainment]; Lip synchronization
(dubbing); Seat reservations for entertainment
events.

[526] 卸棄 : N/A
Disclaimer:

[529] 限制 : N/A
Limitation:

[527] 條件 : N/A
Condition:
其他 : N/A
Others

[220] 提交日期 : 20-09-2021
Date of Filing:

[320] 聲稱具有優先權的日期 : 19-03-2021
Date of Priority Claimed:

[310] 優先權申請編號 : 302021006047
Priority Application Number:

[340] 聲稱具有優先權 (部分) : N/A

Priority Claim Details:

[330] 優先權申請的 GERMANY

國家、地區、地方:

Country, territory, area of

Priority Applications:

[210] 商標申請編號: 305752314

Application No.:

[540] 商標:

Mark:

Olympic Virtual Series

[550] 商標種類: Ordinary

Mark Type:

一系列商標: NO

Series Mark:

[571] 商標描述: N/A

Mark Description:

[730] 註冊申請人的姓名 / 名稱、地址: Comité International Olympique

Applicant(s) ' Château de Vidy

Name,Address: Lausanne 1007

SWITZERLAND

[740/ 註冊申請人的送達地址: BIRD & BIRD

750] Applicant's Address for 6/F, The Annex, Central Plaza

Service: 18 Harbour Road

HONG KONG

[511] 類別編號: 9,25,35,38,41

Class(es) No(s) .:

[511] 貨品 / 服務說明: Class 41:

Specification:

Education; Providing of training;
Entertainment; Sporting and cultural
activities; Publishing, reporting, and writing
of texts; education, entertainment and sport
services; organisation of conferences,
exhibitions and competitions; gambling
services; audio, video and multimedia
production, and photography; sports and
fitness services; education and instruction
services; rental services relating to
equipment and facilities for education,
entertainment, sports and culture; library
services and rental of media; rental of sports
equipment and facilities; rental of
audio/visual and photographic equipment and
facilities; translation and interpretation;
ticket reservation and booking services for
education, entertainment and sports activities
and events.

[526] 卸棄: N/A
Disclaimer:
[529] 限制: N/A
Limitation:
[527] 條件: N/A
Condition:
其他: N/A
Others
[220] 提交日期: 21-09-2021
Date of Filing:
[320] 聲稱具有優先權的日期: 23-03-2021
Date of Priority Claimed:
[310] 優先權申請編號: 04599/2021
Priority Application Number:
[340] 聲稱具有優先權 (部分): N/A
Priority Claim Details:
[330] 優先權申請的 SWITZERLAND
國家、地區、地方:
Country, territory, area of
Priority Applications:

[210] 商標申請編號: 305767958
Application No.:

[540] 商標:
Mark:

SHAREPLAY

[550] 商標種類: Ordinary
Mark Type:
一系列商標: NO
Series Mark:

[571] 商標描述: N/A
Mark Description:

[730] 註冊申請人的姓名 / 名稱、地址: APPLE INC.
Applicant(s) ' ONE APPLE PARK WAY,
Name, Address: CUPERTINO, CALIFORNIA 95014,
UNITED STATES OF AMERICA

[740/ 註冊申請人的送達地址: BAKER & MCKENZIE
750] Applicant's Address for 14TH FLOOR, ONE TAIKOO PLACE,
Service: 979 KING'S ROAD, QUARRY BAY,
HONG KONG

[511] 類別編號: 9, 35, 38, 41, 42
Class(es) No(s) .:

[511] 貨品 / 服務說明: Class 41:
Specification: Educational services; arranging, organizing,
conducting, and presenting concerts, live
performances, entertainment special events,

arts and cultural events, theatrical entertainment, competitions, contests, fairs, festivals, exhibitions, expositions, and sporting events; development, production, distribution, rental, and presentation of radio programs, television programs, motion pictures, multimedia entertainment content, podcasts, and sound recordings; providing ongoing television, radio, audio, video, podcast, and webcast programs; providing entertainment, sports, animation, music, informational, news, reality, documentary, current events, and arts and culture programming by means of telecommunications networks, computer networks, the Internet, satellite, radio, wireless communications networks, television, and cable television for entertainment purposes; providing non-downloadable entertainment, sports, animation, music, informational, news, reality, documentary, current events, and arts and culture programming for entertainment purposes; providing interactive guides for searching, selecting, recording, and archiving television programs, motion pictures, multimedia entertainment content, podcasts, and sound recordings; providing websites and computer applications featuring entertainment, sports, animation, music, informational, news, reality, documentary, current events, and arts and culture programming for entertainment purposes; providing websites and computer applications featuring information in the field of entertainment, sports, music, news, documentaries (news programs), current events (news programs), and arts and culture; entertainment information; providing information, schedules, reviews and personalized recommendations of educational programs, entertainment, motion pictures, theatre, arts and cultural events, concerts, live performances, competitions, fairs, festivals, exhibitions, expositions, and sporting events; publication and presentation of reviews, surveys, and ratings, and providing interactive websites and computer applications for the posting and sharing of reviews, survey, and ratings relating to educational programs, entertainment, motion pictures, theatre, arts and cultural events, concerts, live performances, competitions, fairs, festivals, exhibitions, expositions, and sporting events; providing a website for the uploading, storing, sharing, viewing and posting of images, audio, videos, online journals, blogs, podcasts, and multimedia

content; publication of books, periodicals, newspapers, newsletters, manuals, blogs, journals, and other publications; providing websites and computer applications featuring books, periodicals, newspapers, newsletters, manuals, blogs, journals, and other publications.

[526] 卸棄: N/A
Disclaimer:
[529] 限制: N/A
Limitation:
[527] 條件: N/A
Condition:
其他: N/A
Others
[220] 提交日期: 08-10-2021
Date of Filing:
[320] 聲稱具有優先權的日期: 09-04-2021
Date of Priority Claimed:
[310] 優先權申請編號: 2021-319
Priority Application Number:
[340] 聲稱具有優先權 (部分): N/A
Priority Claim Details:
[330] 優先權申請的 LIECHTENSTEIN
國家、地區、地方:
Country, territory, area of
Priority Applications:

[210] 商標申請編號: 305771601
Application No.:
[540] 商標:
Mark:

REGENT

[550] 商標種類: Ordinary
Mark Type:
一系列商標: NO
Series Mark:
[571] 商標描述: N/A
Mark Description:
[730] 註冊申請人的姓名 / 名稱、地址: REGENT Craft Inc.
Applicant(s) ' 111 South Bedford St. Suite 200
Name, Address: Burlington, MASSACHUSETTS 01803
UNITED STATES OF AMERICA

[740/ 註冊申請人的送達地址 :
750] Applicant's Address for
Service: BAIRUI PATENT & TRADEMARK OFFICE LIMITED
Flat/Rm1502 Easey Commercial Building
253-261 Hennessy Road, Wan Chai
HONG KONG

[511] 類別編號 :
Class(es) No(s) .: 12,37,41

[511] 貨品 / 服務說明 :
Specification: Class 41:
Training in the use and operation of wing-in-
ground-effect vehicles.

[526] 卸棄 :
Disclaimer: N/A

[529] 限制 :
Limitation: N/A

[527] 條件 :
Condition: N/A

其他 :
Others N/A

[220] 提交日期 :
Date of Filing: 14-10-2021

[320] 聲稱具有優先權的日期 :
Date of Priority Claimed: 14-04-2021

[310] 優先權申請編號 :
Priority Application Number: 90646327

[340] 聲稱具有優先權 (部分) :
Priority Claim Details: N/A

[330] 優先權申請的
國家、地區、地方 : UNITED STATES OF AMERICA
Country, territory, area of
Priority Applications:

[210] 商標申請編號 :
Application No.: 305782771

[540] 商標 :
Mark: A

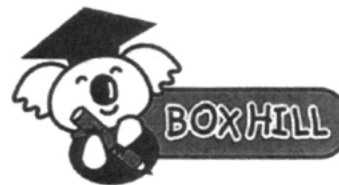

Confidence for a brighter future

B

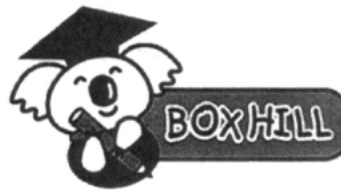

Confidence for a brighter future

C

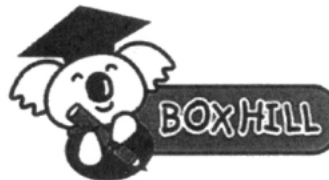

Confidence for a brighter future

D

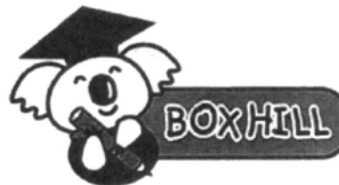

Confidence for a brighter future

[550] 商標種類:

Ordinary

Mark Type:

一系列商標:

YES

Series Mark:

[571] 商標描述:

Mark Description:

The applicant claims the colour black as an element of mark "A" in the series, the colour blue as an element of mark "B" in the series, the colour white as an element of mark "C" in the series, and the colour red as an element of mark "D" in the series.

The pink areas are only used to represent the marks "A", "B", "C" and "D" graphically. These pink areas represent transparent areas. The colour pink is not claimed as part of mark "A", mark "B", mark "C" or mark "D".

[730] 註冊申請人的姓名 / 名稱、地址:

Applicant(s) '
Name, Address:

Box Hill Holdings Limited
Unit 22-23, 18/F., Grandtech Centre
No. 8 On Ping Street, Shatin, N.T.
HONG KONG

[740/ 註冊申請人的送達地址:

750] Applicant's Address for
Service:

Box Hill Holdings Limited
Unit 22-23, 18/F., Grandtech Centre
No. 8 On Ping Street, Shatin, N.T.
HONG KONG

[511] 類別編號:

Class(es) No(s) .:

41

[511] 貨品 / 服務說明 : Specification:	Class 41: Educational information; practical training; correspondence courses; nursery schools; academies; tuition; instruction services; teaching.
[526] 卸棄 : Disclaimer:	N/A
[529] 限制 : Limitation:	N/A
[527] 條件 : Condition: 其他 : Others	N/A
[220] 提交日期 : Date of Filing:	26-10-2021
[320] 聲稱具有優先權的日期 : Date of Priority Claimed:	N/A
[310] 優先權申請編號 : Priority Application Number:	N/A
[340] 聲稱具有優先權 (部分) : Priority Claim Details:	N/A
[330] 優先權申請的 國家、地區、地方 : Country, territory, area of Priority Applications:	N/A

[210] 商標申請編號 : Application No.:	305786182
[540] 商標 : Mark:	A  B 
[550] 商標種類 : Mark Type: 一系列商標 : Series Mark:	Ordinary YES
[571] 商標描述 : Mark Description:	The applicant claims the colours blue and orange as elements of mark "A" in the series.
[730] 註冊申請人的姓名 / 名稱、地址 : Applicant(s)' Name,Address:	INSPIRINGHK SPORTS FOUNDATION LIMITED (凝動香港體育基金有限公司) Unit 1801-02, Jubilee Centre,

46 Gloucester Road, Wanchai
HONG KONG

- [740/ 註冊申請人的送達地址 : BIRD & BIRD
750] Applicant's Address for 6/F, The Annex, Central Plaza
Service: 18 Harbour Road
HONG KONG
- [511] 類別編號 : 36,38,41,42
Class(es) No(s) .:
- [511] 貨品 / 服務說明 : Class 41:
Specification: Education; providing of training;
entertainment; sporting and cultural
activities; online training, instruction and
education services; provision of information
relating to education, training,
entertainment, cultural, art, infotainment,
sport and recreation; provision of information
and interactive information relating to
education, training, entertainment, cultural,
art, infotainment, sport and recreation
provided on-line from computer databases,
computer networks, the Internet or by
electronic means, or accessible via
communication and computer networks; providing
online electronic publications, not
downloadable; providing online videos, not
downloadable.
- [526] 卸棄 : N/A
Disclaimer:
- [529] 限制 : N/A
Limitation:
- [527] 條件 : N/A
Condition:
- 其他 : N/A
Others
- [220] 提交日期 : 29-10-2021
Date of Filing:
- [320] 聲稱具有優先權的日期 : N/A
Date of Priority Claimed:
- [310] 優先權申請編號 : N/A
Priority Application Number:
- [340] 聲稱具有優先權 (部分) : N/A
Priority Claim Details:
- [330] 優先權申請的 N/A
國家、地區、地方 :
Country, territory, area of
Priority Applications:
-
-

- [210] 商標申請編號 : 305792978
Application No.:

[540] 商標 :
Mark:



[550] 商標種類 : Ordinary
Mark Type:
一系列商標 : NO
Series Mark:

[571] 商標描述 : N/A
Mark Description:

[730] 註冊申請人的姓名 / 名稱、地址 : Bauerfeind AG
Applicant(s) ' Triebeser Straße 16
Name,Address: 07937 Zeulenroda-Triebes
GERMANY

[740/ 註冊申請人的送達地址 : CLT PATENT & TRADEMARK (H.K.) LIMITED
750] Applicant's Address for Unit 09, 34/F., Office Tower, Convention Plaza
Service: 1 Harbour Road, Wanchai
HONG KONG

[511] 類別編號 : 10,25,28,35,41
Class(es) No(s) .:

[511] 貨品 / 服務說明 : Class 41:
Specification: Services in the field of education, upbringing, entertainment and sports activities; education and training consulting; education and training in the field of medicine, health care, nutritional supplements, therapeutic treatments and orthopedic medicine; conducting courses, seminars and workshops; sports training, coaching and education, as well as organizing and conducting sports activities; fitness training, fitness teaching and fitness consulting; providing information to consumers regarding educational services, entertainment services and sporting services.

[526] 卸棄 : N/A
Disclaimer:

[529] 限制 : N/A
Limitation:

[527] 條件 : N/A
Condition:

其他 : N/A
Others
[220] 提交日期 : 05-11-2021
Date of Filing:
[320] 聲稱具有優先權的日期 : 14-10-2021
Date of Priority Claimed:
[310] 優先權申請編號 : 018577729
Priority Application Number:
[340] 聲稱具有優先權 (部分) : N/A
Priority Claim Details:
[330] 優先權申請的
國家、地區、地方 : EUROPEAN UNION
Country, territory, area of
Priority Applications:

[210] 商標申請編號 : 305796532
Application No.:

[540] 商標 :
Mark:

ANTKAST

[550] 商標種類 : Ordinary
Mark Type:
一系列商標 : NO
Series Mark:

[571] 商標描述 : N/A
Mark Description:

[730] 註冊申請人的姓名 / 名稱、地址 : Advanced New Technologies Co., Ltd.
Applicant(s) ' Cayman Corporate Centre, 27 Hospital Road,
Name, Address: George Town, Grand Cayman KY1-9008,
CAYMAN ISLANDS

[740/ 註冊申請人的送達地址 : SIMMONS & SIMMONS
750] Applicant's Address for 30th Floor, One Taikoo Place
Service: 979 King's Road,
HONG KONG

[511] 類別編號 : 9, 38, 41, 42
Class(es) No(s) .:

[511] 貨品 / 服務說明 : Class 41:
Specification: Education; providing of training;
entertainment; sporting and cultural
activities; publication of texts, books and
journals (others than publicity texts);
publication of diagrams, images and
photographs; publication of newspapers,
magazines and periodicals; education, training
and instruction services relating to
telecommunications, computers, computer
programs, cloud computing, web site design, e-

commerce, business management, financial management and advertising; provision of education, recreation, instruction, tuition and training both interactive and non-interactive; design of educational courses, examinations and qualifications; entertainment provided via electronic and digital interactive media; electronic games services provided by means of the Internet; provision of information relating to education, training, entertainment, recreation, sporting, social and cultural activities; providing online electronic publications (not downloadable); arranging, organizing, hosting and conducting singing competitions; arranging, organizing, hosting and conducting concerts; arranging, organizing, hosting and conducting events and competitions for education or entertainment purposes; arranging, organizing, hosting and conducting game shows and quests; entertainment ticket agency services; information relating to entertainment or education, provided online from a computer database or the Internet; providing digital music (not downloadable) from the Internet; providing digital music (not downloadable) from MP3 (Moving Picture Experts Group-1 audio layer 3) Internet web sites; entertainment and education services relating to planning, production and distribution of sound, images, digital music, movies, live or recorded audio, visual or audiovisual material for broadcasting on terrestrial cable, satellite channels, the Internet, wireless or wire-link systems and other means of communications; music entertainment services; rental of sound recordings; preparation of entertainment, educational, documentary and news programmes for broadcasting; news reporters' services; information relating to sporting or cultural events, current affairs and breaking news provided by satellite television transmission, the Internet or by other electronic means; television, radio and film production; preparation and production of television programmes; provision of information, data, graphics, sound, music, videos, animation and text for entertainment purpose; game services; provision of club recreation, sporting and gymnasium facilities; band performances; club entertainment, discotheque, fashion show and night club services; club services relating to entertainment, education and cultural services; arranging, conducting and provision of conferences, conventions, congresses,

seminars and training workshops; arranging, conducting and provision of conferences, conventions, congresses, seminars and training workshops in relation to telecommunications, computers, computer programs, cloud computing, web site design, e-commerce, business management, financial management and advertising; organizing and conducting exhibitions, fashion shows, educational shows and cultural shows and performances; art exhibition and gallery services; art gallery services relating to fine arts leasing; training services in relation to occupation health and safety, and environmental conservation; provision of cigar classes, wine tasting classes; providing education information about research materials and agency thereof; arranging, organizing, planning and management of seminars; animal training; direction in producing broadcasting programs; instructional services relating to operation of machines and equipment, including audiovisual equipment, used for the production of broadcasting programs; providing audio and visual studios; providing sports facilities; providing facilities for movies, shows, plays, music or educational training; entertainment booking agencies; rental and leasing of motion pictures (cine -films); rental and leasing of musical instruments; rental and leasing of television programmes; rental and leasing of television sets; lending libraries; archive library services; subtitling services; sign language interpretation services; providing video games, computer games, sound or images, or movies through telecommunication or computer networks; providing online computer games and contests; rental of pre-recorded video tapes; rental and leasing of game machines; lending of arcade game equipment; lending of pictures; photography; translation; language interpretation; educational and training programs in the field of risk management; educational and training programs relating to certification; provision of news; lottery services; providing online videos, not downloadable; tutoring; education and provision of training in relation to climate change and green initiatives; entertainment podcasts (entertainment services); consultancy, information and advisory services relating to the aforesaid services.

[526] 卸棄: N/A

Disclaimer:

[529] 限制: N/A

Limitation:

[527] 條件 : N/A
Condition:
其他 : N/A
Others

[220] 提交日期 : 09-11-2021
Date of Filing:

[320] 聲稱具有優先權的日期 : N/A
Date of Priority Claimed:

[310] 優先權申請編號 : N/A
Priority Application Number:

[340] 聲稱具有優先權 (部分) : N/A
Priority Claim Details:

[330] 優先權申請的
國家、地區、地方 : N/A
Country, territory, area of
Priority Applications:

[210] 商標申請編號 : 305808394
Application No.:

[540] 商標 :
Mark:



[550] 商標種類 : Ordinary
Mark Type:
一系列商標 : NO
Series Mark:

[571] 商標描述 : N/A
Mark Description:

[730] 註冊申請人的姓名 / 名稱、地址 : Chan Zuckerberg Initiative, LLC
Applicant(s) ' 2682 Middlefield Road, Suite i,
Name,Address: Redwood City, California 94063,
UNITED STATES OF AMERICA

[740/ 註冊申請人的送達地址 : MINTERELLISON LLP
750] Applicant's Address for Level 32, Wu Chung House
Service:

213 Queen's Road East
HONG KONG

- [511] 類別編號 : 36, 41, 42
Class(es) No(s) .:
- [511] 貨品 / 服務說明 : Class 41:
Specification: Training of others in the fields of social movements and community building; providing education information in the fields of health, medical and scientific research, computer technology, biotechnology, immigration reform, child welfare, social justice, community building, data analytics, and data science via a website, newsletters and blog articles
- [526] 卸棄 : N/A
Disclaimer:
- [529] 限制 : N/A
Limitation:
- [527] 條件 : N/A
Condition:
其他 : N/A
Others
- [220] 提交日期 : 22-11-2021
Date of Filing:
- [320] 聲稱具有優先權的日期 : 02-06-2021
Date of Priority Claimed:
- [310] 優先權申請編號 : 90750307
Priority Application Number:
- [340] 聲稱具有優先權 (部分) : N/A
Priority Claim Details:
- [330] 優先權申請的
國家、地區、地方 : UNITED STATES OF AMERICA
Country, territory, area of
Priority Applications:
-
-

- [210] 商標申請編號 : 305808402
Application No.:
- [540] 商標 :
Mark:

CZI

- [550] 商標種類 : Ordinary
Mark Type:

一系列商標 : NO
Series Mark:
[571] 商標描述 : N/A
Mark Description:
[730] 註冊申請人的姓名 / 名稱、地址 : Chan Zuckerberg Initiative, LLC
Applicant(s) ' 2682 Middlefield Road, Suite i,
Name,Address: Redwood City, California 94063,
UNITED STATES OF AMERICA
[740/ 註冊申請人的送達地址 : MINTERELLISON LLP
750] Applicant's Address for Level 32, Wu Chung House
Service: 213 Queen's Road East
HONG KONG
[511] 類別編號 : 36,41,42
Class(es) No(s) .:
[511] 貨品 / 服務說明 : Class 41:
Specification: Training of others in the fields of social
movements and community building; providing
education information in the fields of health,
medical and scientific research, computer
technology, biotechnology, immigration reform,
child welfare, social justice, community
building, data analytics, and data science via
a website, newsletters and blog articles
[526] 卸棄 : N/A
Disclaimer:
[529] 限制 : N/A
Limitation:
[527] 條件 : N/A
Condition:
其他 : N/A
Others
[220] 提交日期 : 22-11-2021
Date of Filing:
[320] 聲稱具有優先權的日期 : 02-06-2021
Date of Priority Claimed:
[310] 優先權申請編號 : 90750294
Priority Application Number:
[340] 聲稱具有優先權 (部分) : N/A
Priority Claim Details:
[330] 優先權申請的 UNITED STATES OF AMERICA
國家、地區、地方 :
Country, territory, area of
Priority Applications:

[210] 商標申請編號 : 305808411
Application No.:

[540] 商標 :

CHAN ZUCKERBERG INITIATIVE

Mark:

[550] 商標種類: Ordinary
Mark Type:
一系列商標: NO
Series Mark:

[571] 商標描述: N/A
Mark Description:

[730] 註冊申請人的姓名 / 名稱、地址: Chan Zuckerberg Initiative, LLC
Applicant(s) ' 2682 Middlefield Road, Suite i,
Name, Address: Redwood City, California 94063,
UNITED STATES OF AMERICA

[740/ 註冊申請人的送達地址: MINTERELLISON LLP
750] Applicant's Address for Level 32, Wu Chung House
Service: 213 Queen's Road East
HONG KONG

[511] 類別編號: 36,41,42
Class(es) No(s) .:

[511] 貨品 / 服務說明: Class 41:
Specification: Training of others in the fields of social
movements and community building; providing
education information in the fields of health,
medical and scientific research, computer
technology, biotechnology, immigration reform,
child welfare, social justice, community
building, data analytics, and data science via
a website, newsletters and blog articles

[526] 卸棄: N/A
Disclaimer:

[529] 限制: N/A
Limitation:

[527] 條件: N/A
Condition:
其他: N/A
Others

[220] 提交日期: 22-11-2021
Date of Filing:

[320] 聲稱具有優先權的日期: 02-06-2021
Date of Priority Claimed:

[310] 優先權申請編號: 90750268
Priority Application Number:

[340] 聲稱具有優先權 (部分): N/A
Priority Claim Details:

[330] 優先權申請的 UNITED STATES OF AMERICA
國家、地區、地方:
Country, territory, area of
Priority Applications:

- [210] 商標申請編號 : 305808592
Application No.:
- [540] 商標 :
Mark:
- 
- [550] 商標種類 : Ordinary
Mark Type:
一系列商標 : NO
Series Mark:
- [571] 商標描述 : N/A
Mark Description:
- [730] 註冊申請人的姓名 / 名稱、地址 : L'OREAL
Applicant(s) ' 14 RUE ROYALE,
Name, Address: 75008 PARIS,
FRANCE
- [740/ 註冊申請人的送達地址 : BAKER & MCKENZIE
750] Applicant's Address for 14TH FLOOR, ONE TAIKOO PLACE,
Service: 979 KING'S ROAD, QUARRY BAY,
HONG KONG
- [511] 類別編號 : 35, 41, 42
Class(es) No(s) .:
- [511] 貨品 / 服務說明 : Class 41:
Specification: Educational services relating to environmental
sustainability issues and sustainable
consumption choices with respect to beauty
products; training in the field of
environmental sustainability issues and
sustainable consumption choices with respect
to beauty products.
- [526] 卸棄 : N/A
Disclaimer:
- [529] 限制 : N/A
Limitation:
- [527] 條件 : N/A
Condition:
其他 : N/A
Others
- [220] 提交日期 : 22-11-2021
Date of Filing:
- [320] 聲稱具有優先權的日期 : 18-10-2021
Date of Priority Claimed:
- [310] 優先權申請編號 : 4809428
Priority Application Number:
- [340] 聲稱具有優先權 (部分) : N/A
Priority Claim Details:
- [330] 優先權申請的 FRANCE
國家、地區、地方 :
Country, territory, area of
Priority Applications:

[210] 商標申請編號 : 305808899
Application No.:

[540] 商標 :
Mark:

TANSO

[550] 商標種類 : Ordinary
Mark Type:
一系列商標 : NO
Series Mark:

[571] 商標描述 : N/A
Mark Description:

[730] 註冊申請人的姓名 / 名稱、地址 : NCK LIMITED
Applicant(s) ' Name, Address: FLAT/RM E, BLK2, 28/F, VIGOR IND BLDG,
49-53 TA CHUEN PING STREET, KWAI CHUNG, N.T.,
HONG KONG

[740/ 註冊申請人的送達地址 : PROREG INTELLECTUAL PROPERTY CONSULTING
750] Applicant's Address for Service: LIMITED
29/F, Tower 5 The Gateway, Harbour City,
15 Canton Road, Tsim Sha Tsui, Kowloon,
HONG KONG

[511] 類別編號 : 16, 41
Class(es) No(s):

[511] 貨品 / 服務說明 : Class 41:
Specification: Book publishing; advisory services relating to
electronic publishing; advisory services
relating to publishing; books and magazines
publishing services; consulting services
relating to publishing; desk top publishing;
electronic desktop publishing; electronic
publishing services; magazine publishing;
music publishing services; provision of
information relation to publishing; publishing
of books; publishing of instructional books;
publishing of magazines; publishing of printed
matter; publishing of stories; publishing
services; presentation of works of visual art
or literature to the public for cultural or
educational purposes; computer publications in
electronic form provided on the Internet [not
downloadable]; consultation services relating
to publication of books, magazines and written
texts; consultation services relating to the
publication of books, magazines, periodical
and written texts; online publication of
electronic books and journals; providing
electronic publications [not downloadable];
publication of books, manuals and
documentations; publication of instructional

literature; publication of leaflets; publication of literature; publication of music books; publication of posters; rental of publications; Education services; educational, training and instruction services; school services; academic educational services; education services, namely, organizing, planning, arranging, conducting and providing educational programmes, tutorials, courses and examinations, learning courses, preschool courses, educational sessions and lectures; teaching services; training services, namely, providing, arranging and conducting of training programmes and courses, sessions, lectures and workshops including those featuring information of and relating to parent-child relationship and education; arranging and conducting business conferences; arranging and conducting business or commercial conventions or conferences; arranging and conducting of conferences relating to business; arranging and conducting of conferences relating to trade; all the aforesaid services included in Class 41.

- [526] 卸棄 : N/A
Disclaimer:
- [529] 限制 : N/A
Limitation:
- [527] 條件 : N/A
Condition:
其他 : N/A
Others
- [220] 提交日期 : 22-11-2021
Date of Filing:
- [320] 聲稱具有優先權的日期 : N/A
Date of Priority Claimed:
- [310] 優先權申請編號 : N/A
Priority Application Number:
- [340] 聲稱具有優先權 (部分) : N/A
Priority Claim Details:
- [330] 優先權申請的 : N/A
國家、地區、地方 :
Country, territory, area of
Priority Applications:

-
- [210] 商標申請編號 : 305810201
Application No.:

[540] 商標 :	
Mark:	
[550] 商標種類 :	Ordinary
Mark Type:	
一系列商標 :	NO
Series Mark:	
[571] 商標描述 :	N/A
Mark Description:	
[730] 註冊申請人的姓名 / 名稱、地址 :	APPLE INC.
Applicant(s) ' Name, Address:	ONE APPLE PARK WAY, CUPERTINO, CALIFORNIA 95014, UNITED STATES OF AMERICA
[740/ 註冊申請人的送達地址 :	BAKER & MCKENZIE
750] Applicant's Address for Service:	14TH FLOOR, ONE TAIKOO PLACE, 979 KING'S ROAD, QUARRY BAY, HONG KONG
[511] 類別編號 :	9, 41
Class(es) No(s) .:	
[511] 貨品 / 服務說明 :	Class 41:
Specification:	Audio engineering services, namely mixing, recording, reproducing, manipulating, and equalizing sound and music recordings; providing consulting and information services concerning audio and music production; providing audio and music production services; entertainment services, namely providing prerecorded audio content, information and commentary in the field of music on-line via a global computer network; entertainment services, namely recording, production, and post-production services in the field of music.
[526] 卸棄 :	N/A
Disclaimer:	
[529] 限制 :	N/A
Limitation:	
[527] 條件 :	N/A
Condition:	
其他 :	N/A
Others	
[220] 提交日期 :	23-11-2021
Date of Filing:	
[320] 聲稱具有優先權的日期 :	19-08-2021
Date of Priority Claimed:	
[310] 優先權申請編號 :	84114
Priority Application Number:	
[340] 聲稱具有優先權 (部分) :	N/A
Priority Claim Details:	
[330] 優先權申請的 國家、地區、地方 :	JAMAICA

Country, territory, area of
Priority Applications:

[210] 商標申請編號 : 305811020
Application No.:

[540] 商標 :
Mark:

The logo for 'Regnan' is displayed in a bold, black, serif font. The letter 'R' is significantly larger and more prominent than the other letters, which are of a standard size and weight.

[550] 商標種類 : Ordinary
Mark Type:
一系列商標 : NO
Series Mark:

[571] 商標描述 : N/A
Mark Description:

[730] 註冊申請人的姓名 / 名稱、地址 : Pendal Group Limited
Applicant(s) ' L14 The Chifley Tower, 2 Chifley Sq,
Name,Address: SYDNEY, NSW, 2000,
AUSTRALIA

[740/ 註冊申請人的送達地址 : MINTERELLISON LLP
750] Applicant's Address for Level 32, Wu Chung House
Service: 213 Queen's Road East
HONG KONG

[511] 類別編號 : 16,35,36,41
Class(es) No(s) .:

[511] 貨品 / 服務說明 : Class 41:
Specification: Education services; business educational
services; training; business training
services; commercial training services;
educational seminars; arranging and conducting
of seminars and workshops (training);
arranging and conducting of seminars and
workshops (training) for trustees; conducting
training seminars; practical training
(demonstration); arranging and conducting of
symposiums; arranging and conducting of
conferences; publication of educational
materials; information, advisory and
consultancy services in relation to the
aforementioned services; including provision
of all the aforementioned services
electronically including via the internet

[526] 卸棄 : N/A
Disclaimer:

[529] 限制 : N/A
Limitation:

[527] 條件 : N/A
Condition:
其他 : N/A
Others

[220] 提交日期 : 24-11-2021
Date of Filing:

[320] 聲稱具有優先權的日期 : 03-06-2021
Date of Priority Claimed:

[310] 優先權申請編號 : 2184054
Priority Application Number:

[340] 聲稱具有優先權 (部分) : N/A
Priority Claim Details:

[330] 優先權申請的
國家、地區、地方 : AUSTRALIA
Country, territory, area of
Priority Applications:

[210] 商標申請編號 : 305813668
Application No.:

[540] 商標 :
Mark:

KAMISMAX

[550] 商標種類 : Ordinary
Mark Type:
一系列商標 : NO
Series Mark:

[571] 商標描述 : N/A
Mark Description:

[730] 註冊申請人的姓名 / 名稱、地址 : INVADE Co., Ltd.
Applicant(s) ' GINZA SIX 11F, 6-10-1, Ginza,
Name, Address: Chuo-ku, Tokyo,
JAPAN

[740/ 註冊申請人的送達地址 :
750] Applicant's Address for MAYER BROWN
Service: 16th-19th Floors, Prince's Building,
10 Chater Road, Central,
HONG KONG

[511] 類別編號 : 3, 9, 35, 41, 42, 44
Class(es) No(s) .:

[511] 貨品 / 服務說明 : Class 41:
Specification: Providing videos from the internet, not
downloadable; movie theatre presentations or
movie film production and distribution;
providing digital music from the internet, not
downloadable; presentation of live show
performances; direction or presentation of
plays; presentation of musical performances;

beauty arts instruction; educational and instruction services relating to arts, crafts, sports or general knowledge; arranging, conducting and organization of seminars; arranging of beauty contests; organization of fashion shows for entertainment purposes; organization of entertainment events excluding movies, shows, plays, musical performances, sports, horse races, bicycle races, boat races and auto races; providing electronic publications; services of reference libraries for literature and documentary records; book rental; art exhibitions; gardens for public admission; caves for public admission; publication of books; arranging and planning of movies, shows, plays or musical performances; production of radio or television programs; production of videotape film in the field of education, culture, entertainment or sports [not for movies or television programs and not for advertising or publicity]; organization, arranging and conducting of sports competitions; providing audio or video studio services; providing sports facilities; providing amusement facilities; game services provided online from a computer network; providing facilities for movies, shows, plays, music or educational training; ticket agency services [entertainment]; booking of seats for shows; rental of records or sound-recorded magnetic tapes; rental of image-recorded magnetic tapes; photography; language interpretation; translation.

- [526] 卸棄 : N/A
Disclaimer:
- [529] 限制 : N/A
Limitation:
- [527] 條件 : N/A
Condition:
其他 : N/A
Others
- [220] 提交日期 : 25-11-2021
Date of Filing:
- [320] 聲稱具有優先權的日期 : 09-11-2021
Date of Priority Claimed:
- [310] 優先權申請編號 : 2021-139384
Priority Application Number:
- [340] 聲稱具有優先權 (部分) : N/A
Priority Claim Details:
- [330] 優先權申請的 JAPAN
國家、地區、地方 :
Country, territory, area of
Priority Applications:

[210] 商標申請編號 : 305815297
Application No.:

[540] 商標 :
Mark:

BIENVI

[550] 商標種類 : Ordinary
Mark Type:

一系列商標 : NO
Series Mark:

[571] 商標描述 : N/A
Mark Description:

[730] 註冊申請人的姓名 / 名稱、地址 : GlaxoSmithKline Consumer Healthcare (UK) IP
Applicant(s) ' Limited
Name, Address: 980 Great West Road,
Brentford, Middlesex, TW8 9GS, England
UNITED KINGDOM

[740/ 註冊申請人的送達地址 : WILKINSON & GRIST
750] Applicant's Address for 6th Floor, Prince's Building
Service: Chater Road, Central
HONG KONG

[511] 類別編號 : 3, 5, 9, 10, 21, 29, 30, 32, 35, 36, 41, 42, 44
Class(es) No(s) .:

[511] 貨品 / 服務說明 : Class 41:
Specification: Educational services relating to
pharmaceutical, diagnostic, vaccines,
proprietary medicines, health, medical,
toiletries, skin care and cosmetic industries;
education, providing of training,
entertainment, educational services and
providing of training in relation to smoking
control and smoking cessation; educational
services relating to weight loss, diet,
nutrition and fitness.

[526] 卸棄 : N/A
Disclaimer:

[529] 限制 : N/A
Limitation:

[527] 條件 : N/A
Condition:
其他 : N/A
Others

[220] 提交日期 : 29-11-2021
Date of Filing:

[320] 聲稱具有優先權的日期 : 03-06-2021
Date of Priority Claimed:

[310] 優先權申請編號 : 83440

Priority Application Number:

- [340] 聲稱具有優先權 (部分): for Classes 3, 5, 9, 10, 21, 29, 30, 32, 35,
Priority Claim Details: 41, 42 and 44
- [330] 優先權申請的 JAMAICA
國家、地區、地方:
Country, territory, area of
Priority Applications:
-
-

- [210] 商標申請編號: 305815314
Application No.:

- [540] 商標:
Mark:

HALEON

- [550] 商標種類: Ordinary
Mark Type:
一系列商標: NO
Series Mark:

- [571] 商標描述: N/A
Mark Description:

- [730] 註冊申請人的姓名 / 名稱、地址: GlaxoSmithKline Consumer Healthcare (UK) IP
Applicant(s) ' Limited
Name,Address: 980 Great West Road,
Brentford, Middlesex, TW8 9GS, England,
UNITED KINGDOM

- [740/ 註冊申請人的送達地址: WILKINSON & GRIST
750] Applicant's Address for 6th Floor, Prince's Building
Service: Chater Road, Central
HONG KONG

- [511] 類別編號: 3, 5, 9, 10, 21, 29, 30, 32, 35, 36, 41, 42, 44
Class(es) No(s) .:

- [511] 貨品 / 服務說明: Class 41:
Specification: Educational services relating to
pharmaceutical, diagnostic, vaccines,
proprietary medicines, health, medical,
toiletries, skin care and cosmetic industries,
excluding educational services relating to the
surgical and/or professional vision care
fields; education, providing of training,
entertainment, educational services and
providing of training in relation to smoking
control and smoking cessation; educational
services relating to weight loss, diet,
nutrition and fitness.

- [526] 卸棄: N/A
Disclaimer:

- [529] 限制: N/A
Limitation:

- [527] 條件 : N/A
Condition:
其他 : N/A
Others
- [220] 提交日期 : 29-11-2021
Date of Filing:
- [320] 聲稱具有優先權的日期 : 03-06-2021
Date of Priority Claimed:
- [310] 優先權申請編號 : 83438
Priority Application Number:
- [340] 聲稱具有優先權 (部分) : for Classes 3, 5, 9, 10, 21, 29, 30, 32, 35,
Priority Claim Details: 41, 42 and 44
- [330] 優先權申請的
國家、地區、地方 : JAMAICA
Country, territory, area of
Priority Applications:
-
- [210] 商標申請編號 : 305816287
Application No.:
- [540] 商標 : **TO BE CONTINUED**
Mark:
- [550] 商標種類 : Ordinary
Mark Type:
一系列商標 : NO
Series Mark:
- [571] 商標描述 : N/A
Mark Description:
- [730] 註冊申請人的姓名 / 名稱、地址 : To Be Continued Clothing Limited
Applicant(s) ' Clarendon House, 1 Market Square,
Name, Address: Bicester, Oxfordshire, OX26 6AA
UNITED KINGDOM
- [740/ 註冊申請人的送達地址 : ROBIN BRIDGE & JOHN LIU
750] Applicant's Address for 6th Floor, Emperor Commercial Centre,
Service: 39 Des Voeux Road Central,
HONG KONG
- [511] 類別編號 : 3, 4, 5, 8, 9, 14, 16, 18, 25, 28, 35, 41
Class(es) No(s) .:
- [511] 貨品 / 服務說明 : Class 41:
Specification: Education; providing of training;
entertainment; cultural activities; academies
[education]; arranging and conducting of
concerts; organisation of seminars and
conferences; arranging and conducting of
workshops [training]; arranging of beauty
contests; education information; consultation
services relating to the publication of

magazines; electronic desktop publishing; entertainer services; entertainment information; film production, other than advertising films; game services provided on-line from a computer network; instruction in relation to beauty and fashion comprising guidance, ideas, tips and insights connected to style, fashion, beauty and cosmetics; news reports; night clubs; operating online electronic publications; organisation of competitions; organisation of fashion shows; organisation of parties, festivals and entertainment events; photography; photographic reporting and photographic journalism; presentation of live performances; production of radio and television programmes; providing on-line electronic publications, not downloadable; providing recreation facilities; publication of books; publication of electronic books and journals on-line; publication services relating to electronic magazines; publication of web magazines; publication of books, texts, newspapers, magazines and other printed matter; on-line library services, namely, providing electronic library services which feature newspapers, magazines, photographs and pictures via an online computer network; library services related to data stored and retrieved by electronic means; publication of texts, other than publicity texts; radio entertainment; publishing, editing and production of audio-visual programmes; publishing services for books, magazines and newspapers; recreation information; provision of news information; television production services, television programming services; television production and television programming services provided via streaming on the Internet entertainment club services; discotheque services; education services relating to fashion; provision of training in the field of fashion; model teaching, tuition and training; provision of modelling studios; production and distribution services in the field of sound and/or visual recordings and entertainment; music publishing services; recording studio services; electronic games services provided by means of the Internet (non-downloadable); showing of cinematic films and videos; production and showing of films, sound and video recordings via computer networks, the Internet, wireless communication networks, DSL, cable networks, digital download, digital streaming, video-on-demand, near-video-on-demand, TV, satellite, podcasts, vodcasts, telephone, mobile

telephone, electronic data transfer or radio; on-line entertainment services via computer networks, the Internet, wireless communication networks, DSL, cable networks, digital download, digital streaming, video-on-demand, near-video-on-demand, TV, satellite, podcasts, vodcasts, telephone, mobile telephone, electronic data transfer or radio; production of podcast and vodcasts; booking of entertainment; organisation of competitions, contest, awards and cultural events; arranging of award ceremonies; information, advisory and consultancy services relating to the aforesaid.

- [526] 卸棄 : N/A
Disclaimer:
- [529] 限制 : N/A
Limitation:
- [527] 條件 : N/A
Condition:
其他 : N/A
Others
- [220] 提交日期 : 29-11-2021
Date of Filing:
- [320] 聲稱具有優先權的日期 : 27-05-2021
Date of Priority Claimed:
- [310] 優先權申請編號 : UK00003647835
Priority Application Number:
- [340] 聲稱具有優先權 (部分) : N/A
Priority Claim Details:
- [330] 優先權申請的
國家、地區、地方 : UNITED KINGDOM
Country, territory, area of
Priority Applications:

[210] 商標申請編號 : 305817240
Application No.:

[540] 商標 :
Mark:

A

伙伴創未來

B

夥伴創未來

C

伙伴创未来

- [550] 商標種類 : Ordinary
Mark Type:
一系列商標 : YES
Series Mark:
- [571] 商標描述 : N/A
Mark Description:
- [730] 註冊申請人的姓名 / 名稱、地址 : The Young Entrepreneurs Development Council
Applicant(s) ' Limited
Name,Address: 1/F., 15 Wang Chiu Road,
Kowloon Bay,
HONG KONG
- [740/ 註冊申請人的送達地址 : Rouse & Co. International (Overseas) Limited
750] Applicant's Address for 26/F., Tesbury Centre,
Service: 28 Queen's Road East
HONG KONG
- [511] 類別編號 : 9,16,41
Class(es) No(s) .:
- [511] 貨品 / 服務說明 : Class 41:
Specification: Education, instruction, recreation, teaching and training programs and services (both not provided on-line and provided on-line from computer databases or Internet, non-downloadable); education, instruction, recreation, teaching and training programs and services (provided by way of multi-media means, video games, podcasts, videocasts, webinars and other visual and/or audio means); provision of education, instruction, recreation, teaching, tuition and training (both interactive and non-interactive); coaching; correspondence courses; entertainment services; tutoring; vocational retraining; arranging and conducting of competitions, conferences, conventions, demonstrations, displays, exhibitions, forums, lectures, presentations, shows, seminars, symposiums and workshops for education, instruction, recreation, teaching and training purposes; organization and conducting of education, instruction, teaching and training activities; design of education, instruction, teaching and training courses, programs, examinations and qualifications; dissemination of education, instruction, recreation, teaching and training materials; publication of books, manuals and journals; publication of electronic books, manuals and journals on-line; club services for education, instruction, recreation, teaching and training purposes; lending libraries; publication of texts, books and journals (other than publicity texts); publication of diagrams, images and photographs; publication of newspapers, magazines and periodicals; entertainment provided via electronic and

digital interactive media; electronic games services provided by means of the Internet; providing digital music (not downloadable) from the Internet; providing digital music (not downloadable) from MP3 (Moving Picture Experts Group-1 audio layer 3) Internet web sites; provision of information, data, graphics, sound, music, videos, animation and text for education, instruction, recreation, teaching and training purposes; game services and club services relating to education, entertainment, instruction, recreation, teaching and training services; arranging, providing facilities for movies, shows, plays, music, education, entertainment, instruction, recreation, teaching and training; archive library services; rental of computer game software; rental of education, instruction, recreation, teaching and training materials; providing video games, computer games, sound or images, or movies through telecommunication or computer networks; providing online computer games and contests; rental of pre-recorded video tapes; production of cine-films, video and/or audio tapes, films, disks, mini discs, pre-recorded audio or video tapes, cassettes, compact discs, compact disc read only memories, digital video discs, digital video disc read only memories, laser discs; provision of consultancy, information and advisory services relating to all the aforesaid services; all included in class 41.

- [526] 卸棄 : N/A
Disclaimer:
- [529] 限制 : N/A
Limitation:
- [527] 條件 : N/A
Condition:
其他 : N/A
Others
- [220] 提交日期 : 30-11-2021
Date of Filing:
- [320] 聲稱具有優先權的日期 : N/A
Date of Priority Claimed:
- [310] 優先權申請編號 : N/A
Priority Application Number:
- [340] 聲稱具有優先權 (部分) : N/A
Priority Claim Details:
- [330] 優先權申請的
國家、地區、地方 : N/A
Country, territory, area of
Priority Applications:

[210]	商標申請編號 : Application No.:	305818474
[540]	商標 : Mark:	
[550]	商標種類 : Mark Type:	Ordinary
	一系列商標 : Series Mark:	NO
[571]	商標描述 : Mark Description:	N/A
[730]	註冊申請人的姓名 / 名稱、地址 : Applicant(s)' Name, Address:	Sustainable Apparel Coalition, Inc. #100-272 1714 Franklin Street Oakland CALIFORNIA 946123409 UNITED STATES OF AMERICA
[740/750]	註冊申請人的送達地址 : Applicant's Address for Service:	SPRUSON & FERGUSON (HONG KONG) LIMITED 5001 Hopewell Centre 183 Queen's Road East, Wan Chai HONG KONG
[511]	類別編號 : Class(es) No(s) .:	41
[511]	貨品 / 服務說明 : Specification:	Class 41: Training services to measure environmental impact and management practices of manufacturing facilities for use in sustainability performance measurement.
[526]	卸棄 : Disclaimer:	N/A
[529]	限制 : Limitation:	N/A
[527]	條件 : Condition:	N/A
	其他 : Others	N/A
[220]	提交日期 : Date of Filing:	01-12-2021
[320]	聲稱具有優先權的日期 : Date of Priority Claimed:	24-06-2021
[310]	優先權申請編號 : Priority Application Number:	90/792,171
[340]	聲稱具有優先權 (部分) : Priority Claim Details:	N/A
[330]	優先權申請的 國家、地區、地方 :	UNITED STATES OF AMERICA

Country, territory, area of
Priority Applications:

[210] 商標申請編號 : 305819770
Application No.:

[540] 商標 :
Mark: SONG OF NUNU: A LEAGUE OF LEGENDS STORY

[550] 商標種類 : Ordinary
Mark Type:
一系列商標 : NO
Series Mark:

[571] 商標描述 : N/A
Mark Description:

[730] 註冊申請人的姓名 / 名稱、地址 : Riot Games, Inc.
Applicant(s) ' 12333 W. Olympic Blvd.
Name,Address: Los Angeles, California 90064
UNITED STATES OF AMERICA

[740/ 註冊申請人的送達地址 : BIRD & BIRD
750] Applicant's Address for 6/F, The Annex, Central Plaza
Service: 18 Harbour Road
HONG KONG

[511] 類別編號 : 9,18,25,28,41
Class(es) No(s) .:

[511] 貨品 / 服務說明 : Class 41:
Specification: Providing amusement park rides; amusement park services; entertainment services in the nature of production and presentation of live shows; providing non-downloadable online augmented reality games; providing non-downloadable entertainment information; providing non-downloadable online information about video games; providing non-downloadable online comic books, short stories, and graphic novels; providing non-downloadable video clips and other multimedia digital content; providing non-downloadable video games; providing non-downloadable virtual reality games.

[526] 卸棄 : N/A
Disclaimer:

[529] 限制 : N/A
Limitation:

[527] 條件 : N/A
Condition:
其他 : N/A
Others

[220] 提交日期 : 02-12-2021
Date of Filing:

[320] 聲稱具有優先權的日期 : 16-11-2021
Date of Priority Claimed:

[310] 優先權申請編號 : TO/M/2021/04191
Priority Application Number:

[340] 聲稱具有優先權 (部分) : N/A
Priority Claim Details:

[330] 優先權申請的
國家、地區、地方 : TONGA
Country, territory, area of
Priority Applications:

[210] 商標申請編號 : 305825566
Application No.:

[540] 商標 : A
Mark: 

B

[550] 商標種類 : Ordinary
Mark Type:
一系列商標 : YES
Series Mark:

[571] 商標描述 : N/A
Mark Description:

[730] 註冊申請人的姓名 / 名稱、地址 : Thousand Wisdom Limited (串智有限公司)
Applicant(s) ' Office 1001, 10/F, West Tower, Shun Tak
Name,Address: Centre,
200 Connaught Road Central,
HONG KONG

[740/ 註冊申請人的送達地址 : ACCOLADE IP LIMITED
750] Applicant's Address for 10/F, Fu Fai Comm. Ctr.,
Service: 27 Hillier Street, Sheung Wan,
HONG KONG

[511] 類別編號 : 16,41
Class(es) No(s) .:

[511] 貨品 / 服務說明 : Class 41:
Specification: Education; providing of training;
entertainment; sporting and cultural
activities; online education services;
teaching services; education information
services; providing education service via

online websites, online platforms; organizing, arranging, conducting and providing lectures, talks, workshops including those providing via online websites and online platforms; education services, namely, organizing, arranging, conducting and providing educational programmes, tutorials, classes, courses and examinations, educational sessions and lectures including those providing via online website and online platforms; organizing, arranging, conducting and provision of conferences, conventions, congresses, seminars, meetings and in-person discussion forums; arranging and conducting of in-person educational forums; organizing cultural and arts events; mobile library services; bookmobile services; museum services; animal exhibitions; organization of lotteries; art exhibitions services; publishing services; electronic publishing services; publication services; writing of texts, other than publicity texts; publication of texts, web articles; writing of books and educational books; publishing of books, educational books, magazines, newspapers, newsletters, periodical and journals; production and publication of books, education books, magazines, newspapers, newsletters, periodical, journals, leaflets, booklets, manuals, handbooks; online publication of electronic books, journals, periodicals and magazines; providing online non-downloadable electronic publication for educational purposes; publishing and provision of electronic publications; provision of editing of data, texts, messages, film, audio program, video program, audio visual program, audio content and information, radio, pictures, photos and images services; provision of entertainment and infotainment via electronic and digital interactive media; provision of information in relation to all the aforesaid via online website, social media websites; all the aforesaid services included in Class 41.

- [526] 卸棄 : N/A
Disclaimer:
- [529] 限制 : N/A
Limitation:
- [527] 條件 : N/A
Condition:
- 其他 : N/A
Others
- [220] 提交日期 : 08-12-2021
Date of Filing:
- [320] 聲稱具有優先權的日期 : N/A

Date of Priority Claimed:

[310] 優先權申請編號: N/A

Priority Application Number:

[340] 聲稱具有優先權 (部分): N/A

Priority Claim Details:

[330] 優先權申請的 N/A

國家、地區、地方:

Country, territory, area of

Priority Applications:

[210] 商標申請編號: 305825575

Application No.:

[540] 商標: A

Mark:



B



[550] 商標種類: Ordinary

Mark Type:

一系列商標: YES

Series Mark:

[571] 商標描述: N/A

Mark Description:

- [730] 註冊申請人的姓名 / 名稱、地址 :
Applicant(s) ' Name,Address: Thousand Wisdom Limited (串智有限公司)
Office 1001, 10/F, West Tower, Shun Tak
Centre,
200 Connaught Road Central,
HONG KONG
- [740/ 註冊申請人的送達地址 :
750] Applicant's Address for ACCOLADE IP LIMITED
Service: 10/F, Fu Fai Comm. Ctr.,
27 Hillier Street, Sheung Wan,
HONG KONG
- [511] 類別編號 :
Class(es) No(s) .: 16,41
- [511] 貨品 / 服務說明 :
Specification: Class 41:
Education; providing of training;
entertainment; sporting and cultural
activities; online education services;
teaching services; education information
services; providing education service via
online websites, online platforms; organizing,
arranging, conducting and providing lectures,
talks, workshops including those providing via
online websites and online platforms;
education services, namely, organizing,
arranging, conducting and providing
educational programmes, tutorials, classes,
courses and examinations, educational sessions
and lectures including those providing via
online website and online platforms;
organizing, arranging, conducting and
provision of conferences, conventions,
congresses, seminars, meetings and in-person
discussion forums; arranging and conducting of
in-person educational forums; organizing
cultural and arts events; mobile library
services; bookmobile services; museum
services; animal exhibitions; organization of
lotteries; art exhibitions services;
publishing services; electronic publishing
services; publication services; writing of
texts, other than publicity texts; publication
of texts, web articles; writing of books and
educational books; publishing of books,
educational books, magazines, newspapers,
newsletters, periodical and journals;
production and publication of books, education
books, magazines, newspapers, newsletters,
periodical, journals, leaflets, booklets,
manuals, handbooks; online publication of
electronic books, journals, periodicals and
magazines; providing online non-downloadable
electronic publication for educational
purposes; publishing and provision of
electronic publications; provision of editing
of data, texts, messages, film, audio program,
video program, audio visual program, audio

content and information, radio, pictures, photos and images services; provision of entertainment and infotainment via electronic and digital interactive media; provision of information in relation to all the aforesaid via online website, social media websites; all the aforesaid services included in Class 41.

[526] 卸棄: N/A
Disclaimer:

[529] 限制: N/A
Limitation:

[527] 條件: N/A
Condition:
其他: N/A
Others

[220] 提交日期: 08-12-2021
Date of Filing:

[320] 聲稱具有優先權的日期: N/A
Date of Priority Claimed:

[310] 優先權申請編號: N/A
Priority Application Number:

[340] 聲稱具有優先權 (部分): N/A
Priority Claim Details:

[330] 優先權申請的
國家、地區、地方: N/A
Country, territory, area of
Priority Applications:

[210] 商標申請編號: 305825584
Application No.:

[540] 商標: A
Mark:

紫荊論壇

B

紫荊論壇

[550] 商標種類: Ordinary
Mark Type:

一系列商標: YES

Series Mark:

[571] 商標描述: N/A

Mark Description:

[730] 註冊申請人的姓名 / 名稱、地址: Thousand Wisdom Limited (串智有限公司)
Applicant(s) ' Office 1001, 10/F, West Tower, Shun Tak
Name, Address: Centre,

200 Connaught Road Central,
HONG KONG

[740/ 註冊申請人的送達地址 :

ACCOLADE IP LIMITED

750] Applicant's Address for
Service:

10/F, Fu Fai Comm. Ctr.,
27 Hillier Street, Sheung Wan,
HONG KONG

[511] 類別編號 :

16,41

Class(es) No(s) .:

[511] 貨品 / 服務說明 :

Class 41:

Specification:

Education; providing of training;
entertainment; sporting and cultural
activities; online education services;
teaching services; education information
services; providing education service via
online websites, online platforms; organizing,
arranging, conducting and providing lectures,
talks, workshops including those providing via
online websites and online platforms;
education services, namely, organizing,
arranging, conducting and providing
educational programmes, tutorials, classes,
courses and examinations, educational sessions
and lectures including those providing via
online website and online platforms;
organizing, arranging, conducting and
provision of conferences, conventions,
congresses, seminars, meetings and in-person
discussion forums; arranging and conducting of
in-person educational forums; organizing
cultural and arts events; mobile library
services; bookmobile services; museum
services; animal exhibitions; organization of
lotteries; art exhibitions services;
publishing services; electronic publishing
services; publication services; writing of
texts, other than publicity texts; publication
of texts, web articles; writing of books and
educational books; publishing of books,
educational books, magazines, newspapers,
newsletters, periodical and journals;
production and publication of books, education
books, magazines, newspapers, newsletters,
periodical, journals, leaflets, booklets,
manuals, handbooks; online publication of
electronic books, journals, periodicals and
magazines; providing online non-downloadable
electronic publication for educational
purposes; publishing and provision of
electronic publications; provision of editing
of data, texts, messages, film, audio program,
video program, audio visual program, audio
content and information, radio, pictures,
photos and images services; provision of
entertainment and infotainment via electronic
and digital interactive media; provision of

information in relation to all the aforesaid via online website, social media websites; all the aforesaid services included in Class 41.

[526] 卸棄: N/A
Disclaimer:
[529] 限制: N/A
Limitation:
[527] 條件: N/A
Condition:
其他: N/A
Others
[220] 提交日期: 08-12-2021
Date of Filing:
[320] 聲稱具有優先權的日期: N/A
Date of Priority Claimed:
[310] 優先權申請編號: N/A
Priority Application Number:
[340] 聲稱具有優先權 (部分): N/A
Priority Claim Details:
[330] 優先權申請的
國家、地區、地方: N/A
Country, territory, area of
Priority Applications:

[210] 商標申請編號: 305825692
Application No.:
[540] 商標: A
Mark:

畢安維

B

毕安维

[550] 商標種類: Ordinary
Mark Type:
一系列商標: YES
Series Mark:
[571] 商標描述: N/A
Mark Description:

[730] 註冊申請人的姓名 / 名稱、地址 : GlaxoSmithKline Consumer Healthcare (UK) IP
Applicant(s)' Limited
Name,Address: 980 Great West Road,
Brentford, Middlesex, TW8 9GS, England,
UNITED KINGDOM

[740/ 註冊申請人的送達地址 : WILKINSON & GRIST
750] Applicant's Address for 6th Floor, Prince's Building
Service: Chater Road, Central
HONG KONG

[511] 類別編號 : 3,5,9,10,21,29,30,32,35,36,41,42,44
Class(es) No(s) .:

[511] 貨品 / 服務說明 : Class 41:
Specification: Educational services relating to
pharmaceutical, diagnostic, vaccines,
proprietary medicines, health, medical,
toiletries, skin care and cosmetic industries;
education, providing of training,
entertainment, educational services and
providing of training in relation to smoking
control and smoking cessation; educational
services relating to weight loss, diet,
nutrition and fitness.

[526] 卸棄 : N/A
Disclaimer:

[529] 限制 : N/A
Limitation:

[527] 條件 : N/A
Condition:
其他 : N/A
Others

[220] 提交日期 : 08-12-2021
Date of Filing:

[320] 聲稱具有優先權的日期 : N/A
Date of Priority Claimed:

[310] 優先權申請編號 : N/A
Priority Application Number:

[340] 聲稱具有優先權 (部分) : N/A
Priority Claim Details:

[330] 優先權申請的 N/A
國家、地區、地方 :
Country, territory, area of
Priority Applications:

[210] 商標申請編號 : 305825700
Application No.:

[540] 商標 :	
Mark:	<h1>赫力昂</h1>
[550] 商標種類 :	Ordinary
Mark Type:	
一系列商標 :	NO
Series Mark:	
[571] 商標描述 :	N/A
Mark Description:	
[730] 註冊申請人的姓名 / 名稱、地址 :	GlaxoSmithKline Consumer Healthcare (UK) IP
Applicant(s) ' Name, Address:	Limited 980 Great West Road, Brentford, Middlesex, TW8 9GS, England, UNITED KINGDOM
[740/ 註冊申請人的送達地址 :	WILKINSON & GRIST
750] Applicant's Address for Service:	6th Floor, Prince's Building Chater Road, Central HONG KONG
[511] 類別編號 :	3, 5, 9, 10, 21, 29, 30, 32, 35, 36, 41, 42, 44
Class(es) No(s) .:	
[511] 貨品 / 服務說明 :	Class 41:
Specification:	Educational services relating to pharmaceutical, diagnostic, vaccines, proprietary medicines, health, medical, toiletries, skin care and cosmetic industries, excluding educational services relating to the surgical and/or professional vision care fields; education, providing of training, entertainment, educational services and providing of training in relation to smoking control and smoking cessation; educational services relating to weight loss, diet, nutrition and fitness.
[526] 卸棄 :	N/A
Disclaimer:	
[529] 限制 :	N/A
Limitation:	
[527] 條件 :	N/A
Condition:	
其他 :	N/A
Others	
[220] 提交日期 :	08-12-2021
Date of Filing:	
[320] 聲稱具有優先權的日期 :	N/A
Date of Priority Claimed:	
[310] 優先權申請編號 :	N/A
Priority Application Number:	
[340] 聲稱具有優先權 (部分) :	N/A
Priority Claim Details:	
[330] 優先權申請的	N/A

國家、地區、地方：

Country, territory, area of

Priority Applications:

[210]	商標申請編號： Application No.:	305831587
[540]	商標： Mark:	THE IMPSIDER
[550]	商標種類： Mark Type:	Ordinary
	一系列商標： Series Mark:	NO
[571]	商標描述： Mark Description:	N/A
[730]	註冊申請人的姓名 / 名稱、地址： Applicant(s)' Name, Address:	Sony Interactive Entertainment Europe Limited 10 Great Marlborough Street, London, W1F 7LP, UNITED KINGDOM
[740/ 750]	註冊申請人的送達地址： Applicant's Address for Service:	MINTERELLISON LLP Level 32, Wu Chung House 213 Queen's Road East HONG KONG
[511]	類別編號： Class(es) No(s) .:	9, 38, 41, 42
[511]	貨品 / 服務說明： Specification:	Class 41: Interactive entertainment; Entertainment services; Video entertainment services; Online entertainment services; Online interactive entertainment; Provision of live entertainment; Video game entertainment services; Arranging and conducting award ceremonies; Arranging and conducting competitions; Arranging and conducting of games; Arranging of competitions via the Internet; Art exhibition services; Organisation of artistic competitions; Organisation of competitions and awards; Organisation of e-sports competitions; Organisation of esports events.
[526]	卸棄： Disclaimer:	N/A
[529]	限制： Limitation:	N/A
[527]	條件： Condition:	N/A
	其他：	N/A

Others

[220] 提交日期:	15-12-2021
Date of Filing:	
[320] 聲稱具有優先權的日期:	16-06-2021
Date of Priority Claimed:	
[310] 優先權申請編號:	UK00003656419
Priority Application Number:	
[340] 聲稱具有優先權 (部分):	N/A
Priority Claim Details:	
[330] 優先權申請的 國家、地區、地方:	UNITED KINGDOM
Country, territory, area of Priority Applications:	
<hr/>	
[210] 商標申請編號:	305831604
Application No.:	
[540] 商標:	DREAMIVERSE
Mark:	
[550] 商標種類:	Ordinary
Mark Type:	
一系列商標:	NO
Series Mark:	
[571] 商標描述:	N/A
Mark Description:	
[730] 註冊申請人的姓名 / 名稱、地址:	Sony Interactive Entertainment Europe Limited
Applicant(s)' Name,Address:	10 Great Marlborough Street, London, W1F 7LP, UNITED KINGDOM
[740/ 註冊申請人的送達地址:	MINTERELLISON LLP
750] Applicant's Address for Service:	Level 32, Wu Chung House 213 Queen's Road East HONG KONG
[511] 類別編號:	9,14,16,18,25,28,38,41,42
Class(es) No(s) .:	
[511] 貨品 / 服務說明:	Class 41:
Specification:	Interactive entertainment; Entertainment services; Video entertainment services; Online entertainment services; Online interactive entertainment; Provision of live entertainment; Video game entertainment services; Arranging and conducting award ceremonies; Arranging and conducting competitions; Arranging and conducting of games; Arranging of competitions via the Internet; Art exhibition services;

Organisation of artistic competitions;
 Organisation of competitions and awards;
 Organisation of e-sports competitions;
 Organisation of esports events; entertainment services in the nature of online, non-downloadable game engine software used to create and assemble 2D and 3D graphics and art, music, special effects, gameplay logic, and animations; interactive entertainment services in the nature of online, non-downloadable game engine software used to create digital works of art; video game entertainment services in the nature of online, non-downloadable game engine software for video game development and operation.

- [526] 卸棄 : N/A
 Disclaimer:
- [529] 限制 : N/A
 Limitation:
- [527] 條件 : N/A
 Condition:
 其他 : N/A
 Others
- [220] 提交日期 : 15-12-2021
 Date of Filing:
- [320] 聲稱具有優先權的日期 : 18-06-2021
 Date of Priority Claimed:
- [310] 優先權申請編號 : UK00003657440
 Priority Application Number:
- [340] 聲稱具有優先權 (部分) : N/A
 Priority Claim Details:
- [330] 優先權申請的
 國家、地區、地方 : UNITED KINGDOM
 Country, territory, area of
 Priority Applications:

-
- [210] 商標申請編號 : 305831730
 Application No.:
- [540] 商標 :
 Mark:

Age of Singularities

- [550] 商標種類 : Ordinary
 Mark Type:
 一系列商標 : NO
 Series Mark:

[571] 商標描述 : N/A
Mark Description:

[730] 註冊申請人的姓名 / 名稱、地址 : Awakening Machines INC
Applicant(s) ' Suite 700 100 Wilshire Blvd,
Name,Address: Santa Monica
UNITED STATES OF AMERICA

[740/ 註冊申請人的送達地址 : Hanson Robotics Ltd
750] Applicant's Address for Flat A, 25/F Building Phase 2, Super Luck
Service: Industrial
57 Sha Tsui Road, Tsuen Wan
HONG KONG

[511] 類別編號 : 9,41
Class(es) No(s) .:

[511] 貨品 / 服務說明 : Class 41:
Specification: Entertainment services, namely, an ongoing
multimedia program featuring expressive
animated characters distributed via various
platforms across multiple forms of
transmission media.

[526] 卸棄 : N/A
Disclaimer:

[529] 限制 : N/A
Limitation:

[527] 條件 : N/A
Condition:

其他 : N/A
Others

[220] 提交日期 : 15-12-2021
Date of Filing:

[320] 聲稱具有優先權的日期 : 13-12-2021
Date of Priority Claimed:

[310] 優先權申請編號 : 97168433
Priority Application Number:

[340] 聲稱具有優先權 (部分) : N/A
Priority Claim Details:

[330] 優先權申請的 UNITED STATES OF AMERICA
國家、地區、地方 :
Country, territory, area of
Priority Applications:

[210] 商標申請編號 : 305833530
Application No.:

[540] 商標 :
Mark:

PERIDOT

[550] 商標種類 : Ordinary
Mark Type:

一系列商標 : NO
Series Mark:

[571] 商標描述 : N/A
Mark Description:

[730] 註冊申請人的姓名 / 名稱、地址 : Niantic, Inc.
Applicant(s) ' 1 Ferry Building, Suite 200,
Name, Address: San Francisco, California 94111,
UNITED STATES OF AMERICA

[740/ 註冊申請人的送達地址 : Rouse & Co. International (Overseas) Limited
750] Applicant's Address for 26/F., Tesbury Centre,
Service: 28 Queen's Road East
HONG KONG

[511] 類別編號 : 9, 41, 42, 45
Class(es) No(s) .:

[511] 貨品 / 服務說明 : Class 41:
Specification: Providing online computer games; providing
online video games.

[526] 卸棄 : N/A
Disclaimer:

[529] 限制 : N/A
Limitation:

[527] 條件 : N/A
Condition:
其他 : N/A
Others

[220] 提交日期 : 16-12-2021
Date of Filing:

[320] 聲稱具有優先權的日期 : 29-06-2021
Date of Priority Claimed:

[310] 優先權申請編號 : 083656
Priority Application Number:

[340] 聲稱具有優先權 (部分) : N/A
Priority Claim Details:

[330] 優先權申請的 JAMAICA
國家、地區、地方 :
Country, territory, area of
Priority Applications:

[210] 商標申請編號 : 305836438
Application No.:

[540] 商標 :
Mark:

MONSTER GAMING

[550] 商標種類: Ordinary
Mark Type:
一系列商標: NO
Series Mark:

[571] 商標描述: N/A
Mark Description:

[730] 註冊申請人的姓名 / 名稱、地址: Monster Energy Company
Applicant(s) ' 1 Monster Way,
Name,Address: Corona, California 92879,
UNITED STATES OF AMERICA

[740/ 註冊申請人的送達地址: GALLANT
750] Applicant's Address for 5/F Jardine House,
Service: 1 Connaught Place, Central,
HONG KONG

[511] 類別編號: 36,41
Class(es) No(s) .:

[511] 貨品 / 服務說明: Class 41:
Specification: Arranging contests featuring online gaming;
coordination of game tournaments, leagues, and
tours for recreational computer game playing
purposes; providing a website featuring
information about online gaming and online
gaming professionals; entertainment services
in the nature of sporting events, performances
and competitions, including electronic
sporting events and competitions; providing a
website featuring entertainment information
and news on gaming and gaming professionals.

[526] 卸棄: N/A
Disclaimer:

[529] 限制: N/A
Limitation:

[527] 條件: N/A
Condition:
其他: N/A
Others

[220] 提交日期: 20-12-2021
Date of Filing:

[320] 聲稱具有優先權的日期: 23-06-2021
Date of Priority Claimed:

[310] 優先權申請編號: 90/790885
Priority Application Number:

[340] 聲稱具有優先權 (部分): N/A
Priority Claim Details:

[330] 優先權申請的 UNITED STATES OF AMERICA
國家、地區、地方:
Country, territory, area of
Priority Applications:

- [210] 商標申請編號 : 305836780
Application No.:
- [540] 商標 : A
Mark: 
- B

- [550] 商標種類 : Ordinary
Mark Type:
一系列商標 : YES
Series Mark:
- [571] 商標描述 : N/A
Mark Description:
- [730] 註冊申請人的姓名 / 名稱、地址 : Hong Kong Science and Technology Parks Corporation
Applicant(s) ' Name,Address: 5/F, Building 5E, 5 Science Park East Avenue, Hong Kong Science Park, HONG KONG
- [740/ 註冊申請人的送達地址 : DEACONS
750] Applicant's Address for Service: 5th Floor, Alexandra House Central HONG KONG
- [511] 類別編號 : 9,16,35,41
Class(es) No(s) .:
- [511] 貨品 / 服務說明 : Class 41:
Specification: Education; providing of training; entertainment; sporting and cultural activities; Compilation and provision of information relating to conferences, education studies and education research, training facilities; publication of news, texts (other than publicity) by electronics or digital means; arranging and conducting of seminars and workshops; arranging and conducting of classes, workshops, conferences, colloquiums, congresses, lectures, symposiums and seminars for educational purposes; organization of exhibitions for educational purposes; organization of conferences for commercial or advertising purposes; organization of conferences of angel investors for marketing purpose; organization of competitions for educational purpose; providing facilities for education through the application of information technology, multi-media technology; provision of education and training in relation to information technology, science and technology, innovation and intellectual property; production, presentation, and rental of motion picture films; production, presentation, and rental of television and radio programs; production, presentation, and rental of sound and video recordings; production and provision of

entertainment, news, and information (relating to education) via a global communication network, computer networks and on-line from a computer database of the Internet; organization of competitions and competition shows and programs; pitch competition; provision of entertainment, cultural, and educational exhibitions; educational services; training services; on-line education services; on-line training services; providing on-line information relating to education; providing on-line information relating to training services; Educational services, namely conducting classes, workshops, conferences and seminars in the field of business incubation, professional development, career development, leadership, innovation, science and technology; educational services, namely, providing employment development skills and job training classes; educational services, namely, providing courses to expand career opportunities through career development activities, apprenticeship, internship and traineeship programmes; arranging and conducting internship and apprenticeship programmes (training programs); career counselling services (education and training advice); providing mentoring services in relation to incubation programmes, entrepreneurship, leadership, professional development, career development; career information and advisory services (education and training advice); club services for organizing and conducting entertainment and educational activities; health club services for health and fitness training; providing facilities and equipment for the conducting of exhibitions, conventions, shows, conferences, seminars and workshops for educational, training, entertainment, sporting, recreational or cultural purposes; education and development (training); publishing services; providing on-line electronic publications (not downloadable); information, consultancy, and advisory services relating to the aforesaid services; all included in Class 41.

- [526] 卸棄 : N/A
Disclaimer:
- [529] 限制 : N/A
Limitation:
- [527] 條件 : N/A
Condition:
- 其他 : N/A
Others

[220] 提交日期 : 20-12-2021
Date of Filing:
[320] 聲稱具有優先權的日期 : N/A
Date of Priority Claimed:
[310] 優先權申請編號 : N/A
Priority Application Number:
[340] 聲稱具有優先權 (部分) : N/A
Priority Claim Details:
[330] 優先權申請的
國家、地區、地方 : N/A
Country, territory, area of
Priority Applications:

[210] 商標申請編號 : 305836825
Application No.:

[540] 商標 : A
Mark:



B



[550] 商標種類 : Ordinary
Mark Type:

- 一系列商標 : YES
- Series Mark:
- [571] 商標描述 : The applicant claims the colours C5 M11 Y7 K0, C15 M23 Y13 K0, C74 M46 Y47 K0, C16 M79 Y31 K0, C24 M31 Y13 K0, C20 M75 Y39 K0, C16 M90 Y64 K0, C75 M71 Y67 K32, C26 M24 Y20 K0, C35 M82 Y64 K1, C50 M99 Y87 K27 and C55 M71 Y64 K11 as elements of mark "A" in the series and the colours black and white as elements of mark "B" in the series.
- Mark Description:
- [730] 註冊申請人的姓名 / 名稱、地址 : Medialink Entertainment Limited
- Applicant(s) ' Suite 1801-06, Tower 2, The Gateway, Harbour City
- Name,Address: 25 Canton Road, Tsim Sha Tsui Kowloon
- HONG KONG
- [740/ 註冊申請人的送達地址 : Barbara Chiu
- 750] Applicant's Address for Suite 1801-06, Tower 2, The Gateway, Harbour City
- Service: 25 Canton Road, Tsim Sha Tsui
- HONG KONG
- [511] 類別編號 : 16,35,38,41
- Class(es) No(s) .:
- [511] 貨品 / 服務說明 : Class 41:
- Specification: amusement parks services; theme parks services; arranging and conducting of conferences, congresses, exhibitions, seminars, symposiums, workshops, events, competitions and contests; art gallery services; career counselling [education and training advice]; club services [entertainment or education]; design of educational courses, examinations and qualifications; education and training services; entertainment, sports and cultural activities; game services provided on-line from a computer network; health club services [health and fitness training]; leisure centre services; library services or mobile lending services; modelling for artists; photography and digital photography; planning, organising and managing congresses, conferences, colloquiums, symposiums, seminars, lectures, talks and workshops; presentation of awards, plays, concerts and live performance; production and distribution [other than transportation] of motion pictures, broadcasting and television programmes, movies, newspaper, video and audio programmes and music recordings; production of music, broadcasting and television programmes and shows; providing and rental of facilities and apparatus for educational, entertainment, cultural, recreational and sporting purposes; providing non-downloadable electronic publications, books, videos, films and shows; providing school services and higher educational services; provision of

information, advisory and consultancy services in relation to education, entertainment, cultural and sports; publication of electronic publications, books, magazines and journals; publishing services; recording and editing of videos, films and movies; rental of records, tapes, discs, printed matter, instructional and teaching materials, musical instruments, sound systems and equipment, lighting systems and equipment, audio-visual systems and equipment, audio recording equipment and audio-video recording equipment; rental of sports equipment; reservations of tickets for movies, music, shows, artistic performances and cultural events; teaching and tuition services; vocational guidance (education or training advice);

- [526] 卸棄 : N/A
Disclaimer:
- [529] 限制 : N/A
Limitation:
- [527] 條件 : N/A
Condition:
其他 : N/A
Others
- [220] 提交日期 : 20-12-2021
Date of Filing:
- [320] 聲稱具有優先權的日期 : N/A
Date of Priority Claimed:
- [310] 優先權申請編號 : N/A
Priority Application Number:
- [340] 聲稱具有優先權 (部分) : N/A
Priority Claim Details:
- [330] 優先權申請的
國家、地區、地方 : N/A
Country, territory, area of
Priority Applications:

- [210] 商標申請編號 : 305836834
Application No.:

- [540] 商標 : A
Mark:



B



C



D



- [550] 商標種類 : Ordinary
 Mark Type:
 一系列商標 : YES
 Series Mark:
- [571] 商標描述 : The applicant claims the colours PANTONE 198 C, PANTONE 7474 C, PANTONE Cool Gray 9 C and PANTONE 191 C as elements of mark "A" in the series, the colours PANTONE 705 C, PANTONE 7474 C, PANTONE 197 C, PANTONE 191 C, PANTONE 198 C and PANTONE Cool Gray 9 C as elements of mark "B" in the series, the colours PANTONE Black 6 C, PANTONE 7474 C and PANTONE 191 C as elements of mark "C" in the series and the colour white as an element of mark "D" in the series.
- [730] 註冊申請人的姓名 / 名稱、地址 : Medialink Entertainment Limited
 Applicant(s) ' Suite 1801-06,18/F, Tower 2, The Gateway,
 Name,Address: Harbour City
 25 Canton Road, Tsim Sha Tsui, Kowloon,
 HONG KONG
- [740/ 註冊申請人的送達地址 : Barbara Chiu
 750] Applicant's Address for Suite 1801-06,18/F, Tower 2, The Gateway,
 Service: Harbour City
 25 Canton Road, Tsim Sha Tsui, Kowloon,
 HONG KONG
- [511] 類別編號 : 16,35,38,41
 Class(es) No(s) .:
- [511] 貨品 / 服務說明 : Class 41:
 Specification: amusement parks services; theme parks services; arranging and conducting of conferences, congresses, exhibitions, seminars, symposiums, workshops, events, competitions and contests; art gallery services; career counselling [education and training advice]; club services [entertainment

or education]; design of educational courses, examinations and qualifications; education and training services; entertainment, sports and cultural activities; game services provided on-line from a computer network; health club services [health and fitness training]; leisure centre services; library services or mobile lending services; modelling for artists; photography and digital photography; planning, organising and managing congresses, conferences, colloquiums, symposiums, seminars, lectures, talks and workshops; presentation of awards, plays, concerts and live performance; production and distribution [other than transportation] of motion pictures, broadcasting and television programmes, movies, newspaper, video and audio programmes and music recordings; production of music, broadcasting and television programmes and shows; providing and rental of facilities and apparatus for educational, entertainment, cultural, recreational and sporting purposes; providing non-downloadable electronic publications, books, videos, films and shows; providing school services and higher educational services; provision of information, advisory and consultancy services in relation to education, entertainment, cultural and sports; publication of electronic publications, books, magazines and journals; publishing services; recording and editing of videos, films and movies; rental of records, tapes, discs, printed matter, instructional and teaching materials, musical instruments, sound systems and equipment, lighting systems and equipment, audio-visual systems and equipment, audio recording equipment and audio-video recording equipment; rental of sports equipment; reservations of tickets for movies, music, shows, artistic performances and cultural events; teaching and tuition services; vocational guidance (education or training advice);

- [526] 卸棄 : N/A
Disclaimer:
- [529] 限制 : N/A
Limitation:
- [527] 條件 : N/A
Condition:
- 其他 : N/A
Others
- [220] 提交日期 : 20-12-2021
Date of Filing:
- [320] 聲稱具有優先權的日期 : N/A
Date of Priority Claimed:

- [310] 優先權申請編號 : N/A
Priority Application Number:
- [340] 聲稱具有優先權 (部分) : N/A
Priority Claim Details:
- [330] 優先權申請的
國家、地區、地方 : N/A
Country, territory, area of
Priority Applications:
-
-

- [210] 商標申請編號 : 305836843
Application No.:

- [540] 商標 : A
Mark:



B



- [550] 商標種類 : Ordinary
Mark Type:
- 一系列商標 : YES
Series Mark:

- [571] 商標描述 : The applicant claims the colours C5 M11 Y7 K0,
Mark Description: C15 M23 Y13 K0, C74 M46 Y47 K0, C16 M79 Y31

K0, C24 M31 Y13 K0, C20 M75 Y39 K0, C16 M90 Y64 K0, C75 M71 Y67 K32, C26 M24 Y20 K0, C35 M82 Y64 K1, C50 M99 Y87 K27 and C55 M71 Y64 K11 as elements of mark "A" in the series and the colours black and white as elements of mark "B" in the series.

[730] 註冊申請人的姓名 / 名稱、地址 :
Applicant(s)'
Name,Address:

Medialink Entertainment Limited
Suites 1801-6, 18/F, Tower 2, The Gateway,
Harbour City
25 Canton Road, Tsim Sha Tsui, Kowloon,
HONG KONG

[740/ 註冊申請人的送達地址 :

Barbara Chiu

750] Applicant's Address for
Service:

Suites 1801-6, 18/F, Tower 2, The Gateway,
Harbour City
HONG KONG

[511] 類別編號 :
Class(es) No(s) .:

16,35,38,41

[511] 貨品 / 服務說明 :
Specification:

Class 41:
amusement parks services; theme parks services; arranging and conducting of conferences, congresses, exhibitions, seminars, symposiums, workshops, events, competitions and contests; art gallery services; career counselling [education and training advice]; club services [entertainment or education]; design of educational courses, examinations and qualifications; education and training services; entertainment, sports and cultural activities; game services provided on-line from a computer network; health club services [health and fitness training]; leisure centre services; library services or mobile lending services; modelling for artists; photography and digital photography; planning, organising and managing congresses, conferences, colloquiums, symposiums, seminars, lectures, talks and workshops; presentation of awards, plays, concerts and live performance; production and distribution [other than transportation] of motion pictures, broadcasting and television programmes, movies, newspaper, video and audio programmes and music recordings; production of music, broadcasting and television programmes and shows; providing and rental of facilities and apparatus for educational, entertainment, cultural, recreational and sporting purposes; providing non-downloadable electronic publications, books, videos, films and shows; providing school services and higher educational services; provision of information, advisory and consultancy services in relation to education, entertainment, cultural and sports; publication of electronic publications, books, magazines and journals; publishing services; recording and editing of

videos, films and movies; rental of records, tapes, discs, printed matter, instructional and teaching materials, musical instruments, sound systems and equipment, lighting systems and equipment, audio-visual systems and equipment, audio recording equipment and audio-video recording equipment; rental of sports equipment; reservations of tickets for movies, music, shows, artistic performances and cultural events; teaching and tuition services; vocational guidance (education or training advice);

[526] 卸棄 : N/A
Disclaimer:

[529] 限制 : N/A
Limitation:

[527] 條件 : N/A
Condition:
其他 : N/A
Others

[220] 提交日期 : 20-12-2021
Date of Filing:

[320] 聲稱具有優先權的日期 : N/A
Date of Priority Claimed:

[310] 優先權申請編號 : N/A
Priority Application Number:

[340] 聲稱具有優先權 (部分) : N/A
Priority Claim Details:

[330] 優先權申請的
國家、地區、地方 : N/A
Country, territory, area of
Priority Applications:

[210] 商標申請編號 : 305838139
Application No.:

[540] 商標 : A
Mark:

HKSTP  **創科學院**

B

HKSTP  **创科学院**

[550] 商標種類 : Ordinary
Mark Type:
一系列商標 : YES
Series Mark:

- [571] 商標描述 : N/A
Mark Description:
- [730] 註冊申請人的姓名 / 名稱、地址 : Hong Kong Science and Technology Parks Corporation
Applicant(s) ' 5/F, Building 5E, 5 Science Park East Avenue,
Name,Address: Hong Kong Science Park,
HONG KONG
- [740/ 註冊申請人的送達地址 : DEACONS
750] Applicant's Address for 5th Floor,
Service: Alexandra House Central
HONG KONG
- [511] 類別編號 : 9,16,35,41
Class(es) No(s) .:
- [511] 貨品 / 服務說明 : Class 41:
Specification: Education; providing of training;
entertainment; sporting and cultural activities; Compilation and provision of information relating to conferences, education studies and education research, training facilities; publication of news, texts (other than publicity) by electronics or digital means; arranging and conducting of seminars and workshops; arranging and conducting of classes, workshops, conferences, colloquiums, congresses, lectures, symposiums and seminars for educational purposes; organization of exhibitions for educational purposes; organization of conferences for commercial or advertising purposes; organization of conferences of angel investors for marketing purpose; organization of competitions for educational purpose; providing facilities for education through the application of information technology, multi-media technology; provision of education and training in relation to information technology, science and technology, innovation and intellectual property; production, presentation, and rental of motion picture films; production, presentation, and rental of television and radio programs; production, presentation, and rental of sound and video recordings; production and provision of entertainment, news, and information (relating to education) via a global communication network, computer networks and on-line from a computer database of the Internet; organization of competitions and competition shows and programs; pitch competition; provision of entertainment, cultural, and educational exhibitions; educational services; training services; on-line education services; on-line training services; providing on-line information relating to education; providing on-line information relating to training services; Educational services, namely

conducting classes, workshops, conferences and seminars in the field of business incubation, professional development, career development, leadership, innovation, science and technology; educational services, namely, providing employment development skills and job training classes; educational services, namely, providing courses to expand career opportunities through career development activities, apprenticeship, internship and traineeship programmes; arranging and conducting internship and apprenticeship programmes (training programs); career counselling services (education and training advice); providing mentoring services in relation to incubation programmes, entrepreneurship, leadership, professional development, career development; career information and advisory services (education and training advice); club services for organizing and conducting entertainment and educational activities; health club services for health and fitness training; providing facilities and equipment for the conducting of exhibitions, conventions, shows, conferences, seminars and workshops for educational, training, entertainment, sporting, recreational or cultural purposes; education and development (training); publishing services; providing on-line electronic publications (not downloadable); information, consultancy, and advisory services relating to the aforesaid services; all included in Class 41.

- [526] 卸棄 : N/A
Disclaimer:
- [529] 限制 : N/A
Limitation:
- [527] 條件 : N/A
Condition:
其他 : N/A
Others
- [220] 提交日期 : 21-12-2021
Date of Filing:
- [320] 聲稱具有優先權的日期 : N/A
Date of Priority Claimed:
- [310] 優先權申請編號 : N/A
Priority Application Number:
- [340] 聲稱具有優先權 (部分) : N/A
Priority Claim Details:
- [330] 優先權申請的
國家、地區、地方 : N/A
Country, territory, area of
Priority Applications:

[210] 商標申請編號 : 305838148
Application No.:

[540] 商標 : A
Mark:  大灣區創科飛躍學院

B
 大湾区创科飞跃学院

[550] 商標種類 : Ordinary
Mark Type:
一系列商標 : YES
Series Mark:

[571] 商標描述 : N/A
Mark Description:

[730] 註冊申請人的姓名 / 名稱、地址 : Hong Kong Science and Technology Parks Corporation
Applicant(s) ' Name,Address: 5/F, Building 5E, 5 Science Park East Avenue, Hong Kong Science Park, HONG KONG

[740/ 註冊申請人的送達地址 : DEACONS
750] Applicant's Address for 5th Floor, Service: Alexandra House Central HONG KONG

[511] 類別編號 : 9,16,35,41
Class(es) No(s) .:

[511] 貨品 / 服務說明 : Class 41:
Specification: Education; providing of training; entertainment; sporting and cultural activities; Compilation and provision of information relating to conferences, education studies and education research, training facilities; publication of news, texts (other than publicity) by electronics or digital means; arranging and conducting of seminars and workshops; arranging and conducting of classes, workshops, conferences, colloquiums, congresses, lectures, symposiums and seminars for educational purposes; organization of exhibitions for educational purposes; organization of conferences for commercial or advertising purposes; organization of conferences of angel investors for marketing purpose; organization of competitions for educational purpose; providing facilities for education through the application of information technology, multi-media technology; provision of education and training in relation to information technology, science and technology, innovation and intellectual property; production,

presentation, and rental of motion picture films; production, presentation, and rental of television and radio programs; production, presentation, and rental of sound and video recordings; production and provision of entertainment, news, and information (relating to education) via a global communication network, computer networks and on-line from a computer database of the Internet; organization of competitions and competition shows and programs; pitch competition; provision of entertainment, cultural, and educational exhibitions; educational services; training services; on-line education services; on-line training services; providing on-line information relating to education; providing on-line information relating to training services; Educational services, namely conducting classes, workshops, conferences and seminars in the field of business incubation, professional development, career development, leadership, innovation, science and technology; educational services, namely, providing employment development skills and job training classes; educational services, namely, providing courses to expand career opportunities through career development activities, apprenticeship, internship and traineeship programmes; arranging and conducting internship and apprenticeship programmes (training programs); career counselling services (education and training advice); providing mentoring services in relation to incubation programmes, entrepreneurship, leadership, professional development, career development; career information and advisory services (education and training advice); club services for organizing and conducting entertainment and educational activities; health club services for health and fitness training; providing facilities and equipment for the conducting of exhibitions, conventions, shows, conferences, seminars and workshops for educational, training, entertainment, sporting, recreational or cultural purposes; education and development (training); publishing services; providing on-line electronic publications (not downloadable); information, consultancy, and advisory services relating to the aforesaid services; all included in Class 41.

- [526] 卸棄 :
Disclaimer:
[529] 限制 :
Limitation:

N/A

N/A

[527] 條件 :	N/A
Condition:	
其他 :	N/A
Others	
[220] 提交日期 :	21-12-2021
Date of Filing:	
[320] 聲稱具有優先權的日期 :	N/A
Date of Priority Claimed:	
[310] 優先權申請編號 :	N/A
Priority Application Number:	
[340] 聲稱具有優先權 (部分) :	N/A
Priority Claim Details:	
[330] 優先權申請的 國家、地區、地方 :	N/A
Country, territory, area of Priority Applications:	
<hr/>	
[210] 商標申請編號 :	305838157
Application No.:	
[540] 商標 :	A
Mark:	
	B
	
[550] 商標種類 :	Ordinary
Mark Type:	
一系列商標 :	YES
Series Mark:	
[571] 商標描述 :	N/A
Mark Description:	
[730] 註冊申請人的姓名 / 名稱、地址 :	Hong Kong Science and Technology Parks Corporation
Applicant(s) ' Name, Address:	5/F, Building 5E, 5 Science Park East Avenue, Hong Kong Science Park, HONG KONG
[740/ 註冊申請人的送達地址 :	DEACONS
750] Applicant's Address for Service:	5th Floor, Alexandra House Central HONG KONG
[511] 類別編號 :	35, 36, 39, 41, 45
Class(es) No(s) .:	
[511] 貨品 / 服務說明 :	Class 41:
Specification:	Organization of conferences for commercial or advertising purposes; organization of conferences of angel investors for marketing purpose.

[526]	卸棄: Disclaimer:	N/A
[529]	限制: Limitation:	N/A
[527]	條件: Condition: 其他: Others	N/A
[220]	提交日期: Date of Filing:	21-12-2021
[320]	聲稱具有優先權的日期: Date of Priority Claimed:	N/A
[310]	優先權申請編號: Priority Application Number:	N/A
[340]	聲稱具有優先權 (部分): Priority Claim Details:	N/A
[330]	優先權申請的 國家、地區、地方: Country, territory, area of Priority Applications:	N/A
<hr/>		
[210]	商標申請編號: Application No.:	305838166
[540]	商標: Mark:	A  B 
[550]	商標種類: Mark Type: 一系列商標: Series Mark:	Ordinary YES
[571]	商標描述: Mark Description:	N/A
[730]	註冊申請人的姓名 / 名稱、地址: Applicant(s) ' Name, Address:	Hong Kong Science and Technology Parks Corporation 5/F, Building 5E, 5 Science Park East Avenue, Hong Kong Science Park, HONG KONG
[740/ 750]	註冊申請人的送達地址: Applicant's Address for Service:	DEACONS 5th Floor, Alexandra House Central HONG KONG
[511]	類別編號:	35, 36, 39, 41, 45

Class(es) No(s) .:

[511] 貨品 / 服務說明 : Specification:	Class 41: Organization of conferences for commercial or advertising purposes; organization of conferences of angel investors for marketing purpose.
[526] 卸棄 : Disclaimer:	N/A
[529] 限制 : Limitation:	N/A
[527] 條件 : Condition: 其他 : Others	N/A
[220] 提交日期 : Date of Filing:	21-12-2021
[320] 聲稱具有優先權的日期 : Date of Priority Claimed:	N/A
[310] 優先權申請編號 : Priority Application Number:	N/A
[340] 聲稱具有優先權 (部分) : Priority Claim Details:	N/A
[330] 優先權申請的 國家、地區、地方 : Country, territory, area of Priority Applications:	N/A

[210] 商標申請編號 : Application No.:	305838175
[540] 商標 : Mark:	A 
	B 
[550] 商標種類 : Mark Type:	Ordinary
一系列商標 : Series Mark:	YES
[571] 商標描述 : Mark Description:	N/A
[730] 註冊申請人的姓名 / 名稱、地址 : Applicant(s)' Name, Address:	Hong Kong Science and Technology Parks Corporation 5/F, Building 5E, 5 Science Park East Avenue, Hong Kong Science Park, HONG KONG

[740/ 註冊申請人的送達地址 : DEACONS
750] Applicant's Address for 5th Floor,
Service: Alexandra House Central
HONG KONG
[511] 類別編號 : 35,36,39,41,45
Class(es) No(s) :
[511] 貨品 / 服務說明 : Class 41:
Specification: Organization of conferences for commercial or
advertising purposes; organization of
conferences of angel investors for marketing
purpose.
[526] 卸棄 : N/A
Disclaimer:
[529] 限制 : N/A
Limitation:
[527] 條件 : N/A
Condition:
其他 : N/A
Others
[220] 提交日期 : 21-12-2021
Date of Filing:
[320] 聲稱具有優先權的日期 : N/A
Date of Priority Claimed:
[310] 優先權申請編號 : N/A
Priority Application Number:
[340] 聲稱具有優先權 (部分) : N/A
Priority Claim Details:
[330] 優先權申請的 N/A
國家、地區、地方 :
Country, territory, area of
Priority Applications:

[210] 商標申請編號 : 305838382
Application No.:

[540] 商標 : **ULTRAMAN ACE**
Mark:

[550] 商標種類 : Ordinary
Mark Type:
一系列商標 : NO
Series Mark:

[571] 商標描述 : N/A
Mark Description:

[730] 註冊申請人的姓名 / 名稱、地址 : KABUSHIKI KAISHA TSUBURAYA PURODAKUSHON
Applicant(s) ' (TSUBURAYA PRODUCTIONS CO., LTD.)
Name,Address: 16-17 Nampeidai-cho,

Shibuya-ku, Tokyo 150-0036,
JAPAN

- [740/ 註冊申請人的送達地址 : WILKINSON & GRIST
750] Applicant's Address for 6th Floor, Prince's Building
Service: Chater Road, Central
HONG KONG
- [511] 類別編號 : 9,16,25,28,41
Class(es) No(s) .:
- [511] 貨品 / 服務說明 : Class 41:
Specification: Planning, arranging or holding of movies,
shows, plays or musical performances; showing,
production or distribution of movies;
providing non-downloadable images, videos or
movies that can be received through the
Internet; production of radio or television
programs; production of videos in the field of
education, culture, entertainment or sports;
directing of radio or television programs;
photography; on-line game services; providing
online non-downloadable music, images, videos
and movies; providing videos from the
Internet, not downloadable; providing digital
music from the Internet, not downloadable;
arranging, conducting and organizing
entertainment events excluding movies, shows,
plays, musical performances, sports, horse
races, bicycle races, boat races and auto
races.
- [526] 卸棄 : N/A
Disclaimer:
- [529] 限制 : N/A
Limitation:
- [527] 條件 : N/A
Condition:
其他 : N/A
Others
- [220] 提交日期 : 21-12-2021
Date of Filing:
- [320] 聲稱具有優先權的日期 : N/A
Date of Priority Claimed:
- [310] 優先權申請編號 : N/A
Priority Application Number:
- [340] 聲稱具有優先權 (部分) : N/A
Priority Claim Details:
- [330] 優先權申請的 N/A
國家、地區、地方 :
Country, territory, area of
Priority Applications:
-
-

[210] 商標申請編號 : 305839769
Application No.:
[540] 商標 :
Mark:

JiLiGaGa

[550] 商標種類 : Ordinary
Mark Type:
一 系列商標 : NO
Series Mark:
[571] 商標描述 : N/A
Mark Description:
[730] 註冊申請人的姓名 / 名稱、地址 : OHANA KIDS PTE. LTD. (歐哈納吉德斯私人有限公司)
Applicant(s) ' 112 ROBINSON ROAD #03-01 ROBINSON 112
Name, Address: SINGAPORE
[740/ 註冊申請人的送達地址 : CHINAHONGKONG IP LIMITED
750] Applicant's Address for 1502, 15/F, Capital Centre,
Service: 151 Gloucester Road, Wanchai
HONG KONG
[511] 類別編號 : 9,16,41
Class(es) No(s) .:
[511] 貨品 / 服務說明 : Class 41:
Specification: Instruction services; Teaching; Arranging and
conducting of workshops [training];
Organization of competitions [education or
entertainment]; Lending library services;
Publication of books; Online publication of
electronic books and journals; Providing
online electronic publications, not
downloadable; Production of radio and
television programmes; Entertainment services;
Games equipment rental; Film production, other
than advertising films; Game services provided
online from a computer network; Providing
online videos, not downloadable; Translation;
Organization of shows [impresario services];
Arranging and conducting of in-person
educational forums; Providing electronic
magazines [not downloadable]; Electronic
publishing services; Publishing of books;
Publication of periodicals.

[526] 卸棄:	N/A
Disclaimer:	
[529] 限制:	N/A
Limitation:	
[527] 條件:	N/A
Condition:	
其他:	N/A
Others	
[220] 提交日期:	22-12-2021
Date of Filing:	
[320] 聲稱具有優先權的日期:	N/A
Date of Priority Claimed:	
[310] 優先權申請編號:	N/A
Priority Application Number:	
[340] 聲稱具有優先權 (部分):	N/A
Priority Claim Details:	
[330] 優先權申請的	N/A
國家、地區、地方:	
Country, territory, area of	
Priority Applications:	

[210] 商標申請編號:	305840794
Application No.:	
[540] 商標:	A
Mark:	



B



- [550] 商標種類 : Ordinary
 Mark Type:
 一系列商標 : YES
 Series Mark:
- [571] 商標描述 : N/A
 Mark Description:
- [730] 註冊申請人的姓名 / 名稱、地址 : KREW LIMITED
 Applicant(s) ' 16/F., King Palace Plaza,
 Name,Address: 52A Sha Tsui Road, Tsuen Wan, N.T.,
 HONG KONG
- [740/ 註冊申請人的送達地址 : KREW LIMITED
 750] Applicant's Address for 16/F., King Palace Plaza,
 Service: 52A Sha Tsui Road, Tsuen Wan, N.T.,
 HONG KONG
- [511] 類別編號 : 35,38,41,42
 Class(es) No(s) .:
- [511] 貨品 / 服務說明 : Class 41:
 Specification: Education; providing of training;
 entertainment; cultural activities; providing
 on-line electronic publications; microfilming,
 mobile library service/bookmobile services;
 photography; arranging and conducting of
 seminars for marketing; production of shows;
 television entertainment; competition; rental
 of photographic equipment.
- [526] 卸棄 : N/A
 Disclaimer:
- [529] 限制 : N/A
 Limitation:
- [527] 條件 : N/A
 Condition:
 其他 : N/A
 Others
- [220] 提交日期 : 23-12-2021
 Date of Filing:
- [320] 聲稱具有優先權的日期 : N/A
 Date of Priority Claimed:

[310] 優先權申請編號 : N/A
Priority Application Number:
[340] 聲稱具有優先權 (部分) : N/A
Priority Claim Details:
[330] 優先權申請的 N/A
國家、地區、地方 :
Country, territory, area of
Priority Applications:

[210] 商標申請編號 : 305840811
Application No.:

[540] 商標 : A
Mark:



B



[550] 商標種類 : Ordinary
Mark Type:
一系列商標 : YES
Series Mark:

[571] 商標描述 : N/A
Mark Description:

[730] 註冊申請人的姓名 / 名稱、地址 : KREW LIMITED
Applicant(s) ' 16/F., King Palace Plaza,
Name,Address: 52A Sha Tsui Road, Tsuen Wan, N.T.,
HONG KONG

[740/ 註冊申請人的送達地址 : KREW LIMITED
750] Applicant's Address for 16/F., King Palace Plaza,
Service: 52A Sha Tsui Road, Tsuen Wan, N.T.,
HONG KONG

[511] 類別編號 : 35, 38, 41, 42
Class(es) No(s) .:

[511] 貨品 / 服務說明 : Class 41:
Specification: Education; providing of training;
entertainment; cultural activities; providing
on-line electronic publications; microfilming,
mobile library service/bookmobile services;
photography; arranging and conducting of
seminars for marketing; production of shows;
television entertainment; competition; rental
of photographic equipment.

[526] 卸棄:	N/A
Disclaimer:	
[529] 限制:	N/A
Limitation:	
[527] 條件:	N/A
Condition:	
其他:	N/A
Others	
[220] 提交日期:	23-12-2021
Date of Filing:	
[320] 聲稱具有優先權的日期:	N/A
Date of Priority Claimed:	
[310] 優先權申請編號:	N/A
Priority Application Number:	
[340] 聲稱具有優先權 (部分):	N/A
Priority Claim Details:	
[330] 優先權申請的	N/A
國家、地區、地方:	
Country, territory, area of	
Priority Applications:	

[210] 商標申請編號:	305840820
Application No.:	
[540] 商標:	A
Mark:	
	B
	
[550] 商標種類:	Ordinary
Mark Type:	
一系列商標:	YES
Series Mark:	
[571] 商標描述:	N/A
Mark Description:	
[730] 註冊申請人的姓名 / 名稱、地址:	KREW LIMITED
Applicant(s) 'Name, Address:	16/F., King Palace Plaza, 52A Sha Tsui Road, Tsuen Wan, N.T., HONG KONG
[740/ 註冊申請人的送達地址:	KREW LIMITED
750] Applicant's Address for Service:	16/F., King Palace Plaza,

52A Sha Tsui Road, Tsuen Wan, N.T.,
HONG KONG

- [511] 類別編號 : 35,41
Class(es) No(s) .:
- [511] 貨品 / 服務說明 :
Specification: Class 41:
Education; providing of training;
entertainment; cultural activities; providing
on-line electronic publications; microfilming,
mobile library service/bookmobile services;
photography; arranging and conducting of
seminars for marketing; production of shows;
television entertainment; competition; rental
of photographic equipment.
- [526] 卸棄 : N/A
Disclaimer:
- [529] 限制 : N/A
Limitation:
- [527] 條件 : N/A
Condition:
其他 : N/A
Others
- [220] 提交日期 : 23-12-2021
Date of Filing:
- [320] 聲稱具有優先權的日期 : N/A
Date of Priority Claimed:
- [310] 優先權申請編號 : N/A
Priority Application Number:
- [340] 聲稱具有優先權 (部分) : N/A
Priority Claim Details:
- [330] 優先權申請的
國家、地區、地方 : N/A
Country, territory, area of
Priority Applications:
-
-

- [210] 商標申請編號 : 305840875
Application No.:

[540] 商標 :
Mark:



Alchemy 16

[550] 商標種類 : Ordinary
Mark Type:
一系列商標 : NO
Series Mark:

[571] 商標描述 : N/A
Mark Description:

[730] 註冊申請人的姓名 / 名稱、地址 : ALCHEMY 16 LIMITED
Applicant(s) ' 18/F ON HING BUILDING
Name, Address: 1. ON HING TERRACE CENTRAL,
HONG KONG

[740/ 註冊申請人的送達地址 : ALCHEMY 16 LIMITED
750] Applicant's Address for 18/F ON HING BUILDING
Service: 1 ON HING TERRACE
HONG KONG

[511] 類別編號 : 35, 36, 41, 42
Class(es) No(s) .:

[511] 貨品 / 服務說明 : Class 41:
Specification: Education and training services, arranging and
conducting of conferences, congresses,
seminars, symposiums and training workshops,
publication of electronic publications, books,
magazines and periodicals, arrangement and
holding of conferences, educational councils
and educational exhibitions.

[526] 卸棄 : N/A
Disclaimer:

[529] 限制 : N/A
Limitation:

[527] 條件 : N/A
Condition:
其他 : N/A
Others

[220] 提交日期 : 23-12-2021
Date of Filing:

[320] 聲稱具有優先權的日期 : N/A
Date of Priority Claimed:

[310] 優先權申請編號 : N/A
Priority Application Number:

[340] 聲稱具有優先權 (部分): N/A
Priority Claim Details:
[330] 優先權申請的 N/A
國家、地區、地方:
Country, territory, area of
Priority Applications:

[210] 商標申請編號: 305846004
Application No.:
[540] 商標:
Mark:

BEAUTYMATTER

[550] 商標種類: Ordinary
Mark Type:
一系列商標: NO
Series Mark:
[571] 商標描述: N/A
Mark Description:
[730] 註冊申請人的姓名 / 名稱、地址: NO PLAN B, LLC
Applicant(s) ' 90 William Street, Unit #14H
Name, Address: New York, NY 10038
UNITED STATES OF AMERICA
[740/ 註冊申請人的送達地址: CHINAHONGKONG PATENT LIMITED
750] Applicant's Address for 1502, 15/F, Capital Centre,
Service: 151 Gloucester Road, Wanchai
HONG KONG
[511] 類別編號: 9, 16, 35, 41
Class(es) No(s) .:
[511] 貨品 / 服務說明: Class 41:
Specification: Publication of texts, other than publicity
texts; Publication of books; Online
publication of electronic books and journals;
Providing online electronic publications, not
downloadable; Teaching; Educational services;
Instruction services; Teaching of beauty
skills; Arranging and conducting of workshops
[training].

[526] 卸棄: N/A
Disclaimer:

[529] 限制: N/A
Limitation:

[527] 條件: N/A
Condition:
其他: N/A
Others

[220] 提交日期: 29-12-2021
Date of Filing:

[320] 聲稱具有優先權的日期: N/A
Date of Priority Claimed:

[310] 優先權申請編號: N/A
Priority Application Number:

[340] 聲稱具有優先權 (部分): N/A
Priority Claim Details:

[330] 優先權申請的
國家、地區、地方: N/A
Country, territory, area of
Priority Applications:

[210] 商標申請編號: 305846310
Application No.:

[540] 商標: 
Mark:

[550] 商標種類: Ordinary
Mark Type:
一系列商標: NO
Series Mark:

[571] 商標描述: N/A
Mark Description:

[730] 註冊申請人的姓名 / 名稱、地址: EndoGastric Solutions, Inc.
Applicant(s) ' 18109 NE 76th Street, Suite 100, Redmond,
Name, Address: Washington 98052
UNITED STATES OF AMERICA

[740/ 註冊申請人的送達地址: LUNG TIN PATENT TRADEMARK AGENT LIMITED
750] Applicant's Address for FLAT 11 10/F KOWLOON PLAZA
Service: 485 CASTLE PEAK ROAD CHEUNG SHA WAN
HONG KONG

[511] 類別編號: 41
Class(es) No(s) .:

[511] 貨品 / 服務說明 :
Specification: Class 41:
Educational services, namely, conducting seminars, workshops, individual or collective training, on subjects relating to medical procedures for intragastric surgery; training in the field of intragastric surgery.

[526] 卸棄 :
Disclaimer: N/A

[529] 限制 :
Limitation: N/A

[527] 條件 :
Condition: N/A
其他 :
Others N/A

[220] 提交日期 :
Date of Filing: 30-12-2021

[320] 聲稱具有優先權的日期 :
Date of Priority Claimed: 01-07-2021

[310] 優先權申請編號 :
Priority Application Number: 90807345

[340] 聲稱具有優先權 (部分) :
Priority Claim Details: N/A

[330] 優先權申請的
國家、地區、地方 :
Country, territory, area of
Priority Applications: UNITED STATES OF AMERICA

[210] 商標申請編號 :
Application No.: 305846653

[540] 商標 :
Mark:



[550] 商標種類 :
Mark Type: 一般商標
一系列商標 :
Series Mark: 否

[571] 商標描述 :
Mark Description: 不適用

- [730] 註冊申請人的姓名 / 名稱、地址 : 成都星閱辰石文化發展有限公司
Applicant(s)' 中國
Name, Address: 中國 (四川) 自由貿易試驗區
成都高新區盛邦街 1108 號
- [740/ 註冊申請人的送達地址 : 德龍知識產權集團 (香港) 有限公司
750] Applicant's Address for 香港
Service: 灣仔軒尼詩道 338 號
北海中心 10 樓 E 室
- [511] 類別編號 : 9, 16, 35, 41, 42
Class(es) No(s) .:
- [511] 貨品 / 服務說明 : 類別 41:
Specification: 文字出版 (廣告宣傳文本除外); 通過計算機網絡在線提供的
遊戲服務; 安排和組織研討會; 安排和組織專題研討會; 組織
表演 (演出); 俱樂部服務 (娛樂或教育); 學校教育服務;
電子書籍和雜誌的在線出版; 電視文娛節目; 畫坊 (藝術展覽
服務)。
- [526] 卸棄 : 不適用
Disclaimer:
- [529] 限制 : 不適用
Limitation:
- [527] 條件 : 不適用
Condition:
其他 : 不適用
Others
- [220] 提交日期 : 05-01-2022
Date of Filing:
- [320] 聲稱具有優先權的日期 : 不適用
Date of Priority Claimed:
- [310] 優先權申請編號 : 不適用
Priority Application Number:
- [340] 聲稱具有優先權 (部分) : 不適用
Priority Claim Details:
- [330] 優先權申請的 不適用
國家、地區、地方 :
Country, territory, area of
Priority Applications:
-
-

- [210] 商標申請編號 : 305847021
Application No.:

[540] 商標 :
Mark:



[550] 商標種類 : Ordinary
Mark Type:
一系列商標 : NO
Series Mark:

[571] 商標描述 : N/A
Mark Description:

[730] 註冊申請人的姓名 / 名稱、地址 : GLOBAL STP SPAIN SL
Applicant(s) ' Paseo del Borne N°15, 6F
Name,Address: 07012 Palma de Mallorca (ILLES BALEARS)
SPAIN

[740/ 註冊申請人的送達地址 : Peter Shen & Co. Ltd.
750] Applicant's Address for Suite 801, 8th Floor, K. Wah Centre
Service: 191 Java Road, North Point
HONG KONG

[511] 類別編號 : 25,28,41
Class(es) No(s) .:

[511] 貨品 / 服務說明 : Class 41:
Specification: Entertainment and sporting activities;
publication of texts, magazines, newspapers
and publications of all kinds and in all
formats, including electronic and digital
publications; providing of information
relating to entertainment and sporting
activities via telecommunications networks;
organisation and conducting of colloquiums,
conferences, seminars, symposiums and
congresses in relation to sport; organisation
of competitions, contests, tours and
exhibitions for sporting and educational
purposes; sporting activities relating to
management and development of sporting
projects; organisation, production and
presentation of events and shows for sporting
purposes; organisation of sports competitions;
sports camps; sports training camps; rental of
sports equipment, except vehicles, and rental
of sports fields and tracks; health clubs
(physical fitness); teaching in the field of
rehabilitation and physical improvement; all
of the aforesaid services relating to padel
activity.

[526] 卸棄 : N/A
Disclaimer:

[529] 限制:	N/A
Limitation:	
[527] 條件:	N/A
Condition:	
其他:	N/A
Others	
[220] 提交日期:	30-12-2021
Date of Filing:	
[320] 聲稱具有優先權的日期:	N/A
Date of Priority Claimed:	
[310] 優先權申請編號:	N/A
Priority Application Number:	
[340] 聲稱具有優先權 (部分):	N/A
Priority Claim Details:	
[330] 優先權申請的	N/A
國家、地區、地方:	
Country, territory, area of	
Priority Applications:	
<hr/>	
[210] 商標申請編號:	305847049
Application No.:	
[540] 商標:	
Mark:	<h1>叮叮科創</h1>
[550] 商標種類:	Ordinary
Mark Type:	
一系列商標:	NO
Series Mark:	
[571] 商標描述:	N/A
Mark Description:	
[730] 註冊申請人的姓名 / 名稱、地址:	Tram Plus Limited
Applicant(s)'	Whitty Street Tram Depot
Name, Address:	Connaught Road West, Western District
	HONG KONG
[740/ 註冊申請人的送達地址:	ROBERTSONS
750] Applicant's Address for	57th Floor, The Center
Service:	99 Queen's Road Central
	HONG KONG
[511] 類別編號:	16, 28, 41
Class(es) No(s) .:	
[511] 貨品 / 服務說明:	Class 41:
Specification:	Education; providing of training;
	entertainment; sporting and cultural
	activities; arranging and conducting
	educational activities and events, trainings,
	workshops, seminars and conferences; providing

facilities for education purposes; providing facilities for recreation activities; arranging of events for education purposes; education services providing web-based and classroom training; advisory services in the fields of education and training provided on-line from a computer database or the Internet; advisory services related to education; arranging and conducting of lectures for education purposes; information services relating to education.

- [526] 卸棄 : N/A
Disclaimer:
- [529] 限制 : N/A
Limitation:
- [527] 條件 : N/A
Condition:
其他 : By consent, No. 302758546
Others
- [220] 提交日期 : 30-12-2021
Date of Filing:
- [320] 聲稱具有優先權的日期 : N/A
Date of Priority Claimed:
- [310] 優先權申請編號 : N/A
Priority Application Number:
- [340] 聲稱具有優先權 (部分) : N/A
Priority Claim Details:
- [330] 優先權申請的
國家、地區、地方 : N/A
Country, territory, area of
Priority Applications:
-
-

- [210] 商標申請編號 : 305847445
Application No.:
- [540] 商標 :
Mark:

picEmotion

- [550] 商標種類 : 一般商標
Mark Type:
一系列商標 : 否
Series Mark:

- [571] 商標描述 : 不適用
Mark Description:
- [730] 註冊申請人的姓名 / 名稱、地址 : 連一琪
Applicant(s) ' 香港
Name, Address: 新界荃灣灰窰角街 50-56 號
昌泰工業大廈 1 樓 A2 & A3
- [740/ 註冊申請人的送達地址 : 環曉國際有限公司
750] Applicant's Address for 香港
Service: 成業街 30 號
華富工貿中心 13 樓 1305 室
- [511] 類別編號 : 16, 40, 41
Class(es) No(s) .:
- [511] 貨品 / 服務說明 : 類別 41:
Specification: 實際培訓 (示範); 組織文化或教育展覽; 流動圖書館; 除廣告以外的版面設計; 電子書籍和雜誌的在線出版; 廣播和電視節目製作; 攝影; 組織畫展; 俱樂部服務 (娛樂或教育)
- [526] 卸棄 : 不適用
Disclaimer:
- [529] 限制 : 不適用
Limitation:
- [527] 條件 : 不適用
Condition:
其他 : 不適用
Others
- [220] 提交日期 : 31-12-2021
Date of Filing:
- [320] 聲稱具有優先權的日期 : 不適用
Date of Priority Claimed:
- [310] 優先權申請編號 : 不適用
Priority Application Number:
- [340] 聲稱具有優先權 (部分) : 不適用
Priority Claim Details:
- [330] 優先權申請的 不適用
國家、地區、地方 :
Country, territory, area of
Priority Applications:

[210] 商標申請編號 : 305847490
Application No.:

[540] 商標 : **BEHIND THE BOSS**
Mark:

[550] 商標種類 : Ordinary
Mark Type:

一系列商標 :	NO
Series Mark:	
[571] 商標描述 :	N/A
Mark Description:	
[730] 註冊申請人的姓名 / 名稱、地址 :	HUGO BOSS Trade Mark Management GmbH & Co. KG
Applicant(s) 'Name,Address:	Dieselstr. 12, 72555 Metzingen, GERMANY
[740/ 註冊申請人的送達地址 :	DEACONS
750] Applicant's Address for Service:	5th Floor, Alexandra House Central HONG KONG
[511] 類別編號 :	41
Class(es) No(s) .:	
[511] 貨品 / 服務說明 :	Class 41:
Specification:	Production of podcasts; Creation [writing] of podcasts; Provision of entertainment via podcast; Creation [writing] of educational content for podcasts.
[526] 卸棄 :	N/A
Disclaimer:	
[529] 限制 :	N/A
Limitation:	
[527] 條件 :	N/A
Condition:	
其他 :	N/A
Others	
[220] 提交日期 :	31-12-2021
Date of Filing:	
[320] 聲稱具有優先權的日期 :	N/A
Date of Priority Claimed:	
[310] 優先權申請編號 :	N/A
Priority Application Number:	
[340] 聲稱具有優先權 (部分) :	N/A
Priority Claim Details:	
[330] 優先權申請的	N/A
國家、地區、地方 :	
Country, territory, area of Priority Applications:	
<hr/>	
[210] 商標申請編號 :	305847607
Application No.:	

[540] 商標 :
Mark:



[550] 商標種類 : Ordinary
Mark Type:
一系列商標 : NO
Series Mark:

[571] 商標描述 : N/A
Mark Description:

[730] 註冊申請人的姓名 / 名稱、地址 : HO MIU YAN VIVIAN trading as CHEUNG'S MUSIC &
Applicant(s) ' ART FAMILY (晉仕樂藝教育)
Name, Address: RM 1218, 12/F., PANG KWONG BUILDING,
59 HUNG TO ROAD, KWUN TONG, KOWLOON,
HONG KONG

[740/ 註冊申請人的送達地址 : ACCOLADE IP LIMITED
750] Applicant's Address for 10/F, Fu Fai Comm. Ctr.,
Service: 27 Hillier Street, Sheung Wan,
HONG KONG

[511] 類別編號 : 41
Class(es) No(s) .:

[511] 貨品 / 服務說明 : Class 41:
Specification: Music instruction services; organisation of
musical events; providing information about
music; provision of musical entertainment;
publication of tutorial books in the field of
music and entertainment; teaching of music;
educational and instruction services relating
to music; providing musical courses to
teenagers and adolescents.

[526] 卸棄 : N/A
Disclaimer:

[529] 限制 : N/A
Limitation:

[527] 條件 : N/A
Condition:
其他 : N/A
Others

[220] 提交日期 : 31-12-2021
Date of Filing:

[320] 聲稱具有優先權的日期 : N/A
Date of Priority Claimed:

[310] 優先權申請編號 : N/A
Priority Application Number:

[340] 聲稱具有優先權 (部分) : N/A
Priority Claim Details:

[330] 優先權申請的 N/A

國家、地區、地方:

Country, territory, area of

Priority Applications:

[210] 商標申請編號: 305847968

Application No.:

[540] 商標:

Mark:

MPASS

[550] 商標種類: 一般商標

Mark Type:

一系列商標:

否

Series Mark:

[571] 商標描述: 不適用

Mark Description:

[730] 註冊申請人的姓名 / 名稱、地址:

澳門 MPASS 數字化生活服務一人有限公司

Applicant(s)'

澳門

Name, Address:

宋玉生廣場 322-362 號

誠豐商業中心 3 樓 0 座

[740/ 註冊申請人的送達地址:

麥仕奇知識產權

750] Applicant's Address for

香港

Service:

薄扶林 數碼港道 100 號

數碼港一座 9 樓

[511] 類別編號: 9, 28, 35, 36, 39, 41, 42, 43

Class(es) No(s) .:

[511] 貨品 / 服務說明: 類別 41:

Specification:

培訓; 組織教育或娛樂競賽; 組織體育運動競賽; 提供在線電子出版物 (非下載); 組織彩票發行; 票務代理服務 (娛樂); 娛樂服務; 組織抽獎; 遊戲廳服務; 在計算機網路上提供在線遊戲。

[526] 卸棄: 不適用

Disclaimer:

[529] 限制: 不適用

Limitation:

[527] 條件: 不適用

Condition:

其他:

不適用

Others

[220] 提交日期: 31-12-2021

Date of Filing:

[320] 聲稱具有優先權的日期: 不適用

Date of Priority Claimed:

[310] 優先權申請編號: 不適用

Priority Application Number:

[340] 聲稱具有優先權 (部分): 不適用

Priority Claim Details:

[330] 優先權申請的 不適用

國家、地區、地方:

Country, territory, area of

Priority Applications:

[210] 商標申請編號: 305848020

Application No.:

[540] 商標:

Mark:



Whimark

[550] 商標種類: 一般商標

Mark Type:

一系列商標:

否

Series Mark:

[571] 商標描述: 不適用

Mark Description:

[730] 註冊申請人的姓名 / 名稱、地址:

深圳市前海手繪科技文化有限公司

Applicant(s) '

中國

Name, Address:

深圳市前海深港合作區

南山街道興海大道 3040 號前海世茂金融中心二期 1 棟 3607

[740/ 註冊申請人的送達地址:

BORSAM INTELLECTUAL PROPERTY LIMITED

750] Applicant's Address for

香港

Service:

九龍旺角花園街 75-77 號

花園商業大廈 6 樓 605 室

[511] 類別編號:

9, 38, 41, 42, 45

Class(es) No(s) .:

[511] 貨品 / 服務說明:

類別 41:

Specification:

俱樂部服務 (娛樂或教育); 組織教育或娛樂競賽; 通過計算機網絡在線提供的遊戲服務; 電子書籍和雜誌的在線出版; 提供線上電子出版物 (非下載的); 除廣告片外的影片製作; 錄像帶剪輯; 配字幕; 提供教育信息; 圖書出版 (廣告宣傳冊除外)

[526] 卸棄: 不適用
Disclaimer:

[529] 限制: 不適用
Limitation:

[527] 條件: 不適用
Condition:
其他: 不適用
Others

[220] 提交日期: 31-12-2021
Date of Filing:

[320] 聲稱具有優先權的日期: 不適用
Date of Priority Claimed:

[310] 優先權申請編號: 不適用
Priority Application Number:

[340] 聲稱具有優先權 (部分): 不適用
Priority Claim Details:

[330] 優先權申請的
國家、地區、地方: 不適用
Country, territory, area of
Priority Applications:

[210] 商標申請編號: 305848048
Application No.:

[540] 商標: A
Mark: 

B

[550] 商標種類: Ordinary
Mark Type:
一系列商標: YES
Series Mark:

[571] 商標描述: The applicant claims the colours blue, grey and black as elements of mark "A" in the series.
Mark Description:

[730] 註冊申請人的姓名 / 名稱、地址: Matchlive Limited
Applicant(s) ' Flat B, 9th Floor, Lead On Industrial Building
Name, Address: 18 Ng Fong Street, San Po Kong, Kowloon,
HONG KONG

[740/ 註冊申請人的送達地址: Tung, Ng, Tse & Lam, Solicitors
750] Applicant's Address for 26th Floor, CMA Building,
Service: 64 Connaught Road Central, Central,
HONG KONG

[511] 類別編號: 16, 24, 25, 28, 35, 36, 38, 41
Class(es) No(s) .:

[511] 貨品 / 服務說明 : Specification:	Class 41: television entertainment services; show production services; digital video and video film production services; production and distribution of television programmes, including but not limited to dramas, situation comedies, variety shows, educational, infotainment and culture programmes as well as motion pictures; arranging and organizing exhibitions and competitions for entertainment purposes; organizing and presentation of live and theatrical performances; provision of entertainment information relating to television programmes, motion pictures, artistes and celebrities; all included in Class 41.
[526] 卸棄 : Disclaimer:	N/A
[529] 限制 : Limitation:	N/A
[527] 條件 : Condition: 其他 : Others	N/A
[220] 提交日期 : Date of Filing:	31-12-2021
[320] 聲稱具有優先權的日期 : Date of Priority Claimed:	N/A
[310] 優先權申請編號 : Priority Application Number:	N/A
[340] 聲稱具有優先權 (部分) : Priority Claim Details:	N/A
[330] 優先權申請的 國家、地區、地方 : Country, territory, area of Priority Applications:	N/A

[210] 商標申請編號 : 305848057
Application No.:

[540] 商標 :
Mark:

match LIVE
衝競

[550] 商標種類 : Ordinary
Mark Type:

一系列商標 :	NO
Series Mark:	
[571] 商標描述 :	N/A
Mark Description:	
[730] 註冊申請人的姓名 / 名稱、地址 :	Matchlive Limited
Applicant(s) ' Name,Address:	Flat B, 9th Floor, Lead On Industrial Building 18 Ng Fong Street, San Po Kong, Kowloon, HONG KONG
[740/ 註冊申請人的送達地址 :	Tung, Ng, Tse & Lam, Solicitors
750] Applicant's Address for Service:	26th Floor, CMA Building, 64 Connaught Road Central, Central, HONG KONG
[511] 類別編號 :	16,24,25,28,35,36,38,41
Class(es) No(s) .:	
[511] 貨品 / 服務說明 :	Class 41:
Specification:	television entertainment services; show production services; digital video and video film production services; production and distribution of television programmes, including but not limited to dramas, situation comedies, variety shows, educational, infotainment and culture programmes as well as motion pictures; arranging and organizing exhibitions and competitions for entertainment purposes; organizing and presentation of live and theatrical performances; provision of entertainment information relating to television programmes, motion pictures, artistes and celebrities; all included in Class 41.
[526] 卸棄 :	N/A
Disclaimer:	
[529] 限制 :	N/A
Limitation:	
[527] 條件 :	N/A
Condition:	
其他 :	N/A
Others	
[220] 提交日期 :	31-12-2021
Date of Filing:	
[320] 聲稱具有優先權的日期 :	N/A
Date of Priority Claimed:	
[310] 優先權申請編號 :	N/A
Priority Application Number:	
[340] 聲稱具有優先權 (部分) :	N/A
Priority Claim Details:	
[330] 優先權申請的 國家、地區、地方 :	N/A
Country, territory, area of Priority Applications:	

[210] 商標申請編號: 305848417
Application No.:

[540] 商標:
Mark:

Zenless Zone Zer0

[550] 商標種類: Ordinary
Mark Type:

一系列商標: NO

Series Mark:

[571] 商標描述: N/A
Mark Description:

[730] 註冊申請人的姓名 / 名稱、地址: COGNOSPHERE PTE. LTD. (識隙之城私人有限公司)
Applicant(s) ' Name, Address: 6 Raffles Quay #14-02 048580 SINGAPORE

[740/ 註冊申請人的送達地址: UNITALEN ATTORNEYS AT LAW LIMITED
750] Applicant's Address for RM 1201, 12/F, GOLDEN ERA PLAZA, Service: 39-55 SAI YEE ST, MONGKOK KLN, HONG KONG

[511] 類別編號: 9, 41, 42
Class(es) No(s) .:

[511] 貨品 / 服務說明: Class 41:
Specification: Game services provided online from a computer network; Providing online electronic publications, not downloadable; Online publication of electronic books and journals; Providing online music, not downloadable; Production of music; Arranging and conducting of concerts; Providing online videos, not downloadable; Film production, other than advertising films; Animation production services; Organization of exhibitions for cultural or educational purposes; Organization of electronic game competitions; Organization of competitions [education or entertainment]; Organization of sports competitions; Instruction services; Electronic desktop publishing; Entertainment services; Providing information in the field of entertainment; Providing user rankings for entertainment or cultural purposes; Toy rental; Games equipment rental.

[526] 卸棄: N/A
Disclaimer:

[529] 限制: N/A
Limitation:

[527] 條件: N/A
Condition:

其他 : N/A
Others
[220] 提交日期 : 31-12-2021
Date of Filing:
[320] 聲稱具有優先權的日期 : N/A
Date of Priority Claimed:
[310] 優先權申請編號 : N/A
Priority Application Number:
[340] 聲稱具有優先權 (部分) : N/A
Priority Claim Details:
[330] 優先權申請的
國家、地區、地方 : N/A
Country, territory, area of
Priority Applications:

[210] 商標申請編號 : 305848426
Application No.:
[540] 商標 :
Mark:

絕區零

[550] 商標種類 : Ordinary
Mark Type:
一系列商標 : NO
Series Mark:
[571] 商標描述 : N/A
Mark Description:
[730] 註冊申請人的姓名 / 名稱、地址 : COGNOSPHERE PTE. LTD. (識隙之城私人有限公司)
Applicant(s) ' 6 Raffles
Name, Address: Quay #14-02 048580
SINGAPORE
[740/ 註冊申請人的送達地址 : UNITALEN ATTORNEYS AT LAW LIMITED
750] Applicant's Address for RM 1201, 12/F, GOLDEN ERA PLAZA,
Service: 39-55 SAI YEE ST, MONGKOK KLN,
HONG KONG
[511] 類別編號 : 9, 41, 42
Class(es) No(s) .:

[511] 貨品 / 服務說明 : Specification:	Class 41: Game services provided online from a computer network; Providing online electronic publications, not downloadable; Online publication of electronic books and journals; Providing online music, not downloadable; Production of music; Arranging and conducting of concerts; Providing online videos, not downloadable; Film production, other than advertising films; Animation production services; Organization of exhibitions for cultural or educational purposes; Organization of electronic game competitions; Organization of competitions [education or entertainment]; Organization of sports competitions; Instruction services; Electronic desktop publishing; Entertainment services; Providing information in the field of entertainment; Providing user rankings for entertainment or cultural purposes; Toy rental; Games equipment rental.
[526] 卸棄 : Disclaimer:	N/A
[529] 限制 : Limitation:	N/A
[527] 條件 : Condition: 其他 : Others	N/A
[220] 提交日期 : Date of Filing:	31-12-2021
[320] 聲稱具有優先權的日期 : Date of Priority Claimed:	N/A
[310] 優先權申請編號 : Priority Application Number:	N/A
[340] 聲稱具有優先權 (部分) : Priority Claim Details:	N/A
[330] 優先權申請的 國家、地區、地方 : Country, territory, area of Priority Applications:	N/A

[210] 商標申請編號 : 305850162
Application No.:

[540] 商標 : A
Mark:



B



C



D



[550] 商標種類:	Ordinary
Mark Type:	
一系列商標:	YES
Series Mark:	
[571] 商標描述:	N/A
Mark Description:	
[730] 註冊申請人的姓名 / 名稱、地址:	Lei Shing Hong Limited
Applicant(s) 'Name, Address:	8th Floor, New World Tower I, 18 Queen's Road Central, HONG KONG
[740/ 註冊申請人的送達地址:	MARKS & CLERK
750] Applicant's Address for Service:	Level 9, Cyberport 1 100 Cyberport Road, Pok Fu Lam HONG KONG
[511] 類別編號:	7, 12, 19, 27, 31, 35, 36, 37, 39, 40, 41, 42
Class(es) No(s) .:	
[511] 貨品 / 服務說明:	Class 41:
Specification:	Providing of training relating to repair and maintenance of vehicles, machines, generators, heavy machinery, and engines and their parts and fittings thereof; arranging and conducting of workshops [training]; information, advisory and consultancy services relating to all the aforesaid services.
[526] 卸棄:	N/A
Disclaimer:	
[529] 限制:	N/A
Limitation:	
[527] 條件:	N/A
Condition:	
其他:	N/A
Others	
[220] 提交日期:	05-01-2022
Date of Filing:	
[320] 聲稱具有優先權的日期:	N/A
Date of Priority Claimed:	

[310] 優先權申請編號 : N/A
Priority Application Number:
[340] 聲稱具有優先權 (部分) : N/A
Priority Claim Details:
[330] 優先權申請的 N/A
國家、地區、地方 :
Country, territory, area of
Priority Applications:

[210] 商標申請編號 : 305850342
Application No.:
[540] 商標 :
Mark:



[550] 商標種類 : Ordinary
Mark Type:
一系列商標 : NO
Series Mark:
[571] 商標描述 : N/A
Mark Description:
[730] 註冊申請人的姓名 / 名稱、地址 : Pure Licensing Limited
Applicant(s) ' Trustnet Chambers
Name,Address: P.O. Box 3444
Road Town
Tortola
VIRGIN ISLANDS (BRITISH)
[740/ 註冊申請人的送達地址 : DEACONS
750] Applicant's Address for 5th Floor,
Service: Alexandra House Central
HONG KONG
[511] 類別編號 : 41
Class(es) No(s) .:
[511] 貨品 / 服務說明 : Class 41:
Specification: Yoga teacher training; provision of online
education information for teachers and
students; teaching of yoga exercises; teaching
relating to physical fitness; publication of
teaching materials; vocational guidance
[education or training advice]; vocational
retraining; arranging and conducting training
courses; entertainment, education and training
services; arranging and conducting classes,
seminars, conferences, conventions,

exhibitions and instructor training in the fields of yoga instruction, yoga philosophy, yoga theory and practice, allopathic physical systems, integration of medical and yogic systems, yoga therapy, marketing yoga services, physical fitness, meditation, self-awareness, mental training and discipline, and health, and distributing course materials in connection therewith; organizing sporting and cultural activities; ticket reservation services (entertainment); entertainment information services; entertainer services; provision of club recreation facilities, provision of club sporting facilities, provision of gymnasium facilities, organising of gymnastic events, health club services, provision of keep-fit facilities, leisure centre services, provision of physical education facilities; providing on-line information relating to yoga, sports, entertainment and education; editorial and publication services of books, magazines, leaflets and printed matter relating to yoga, sports, entertainment and education; theatrical entertainment services; provision of the foregoing information, entertainment and recreational services by electronic means; distribution and production of cine-films, video tapes, audio tapes, compact discs, compact disc read only memories, laser discs; production of radio and television programmes, recording studio services; lending library services, library services; provision of information, consultancy services and advisory services relating to all the aforesaid services.

- [526] 卸棄 : N/A
Disclaimer:
- [529] 限制 : N/A
Limitation:
- [527] 條件 : N/A
Condition:
其他 : N/A
Others
- [220] 提交日期 : 05-01-2022
Date of Filing:
- [320] 聲稱具有優先權的日期 : N/A
Date of Priority Claimed:
- [310] 優先權申請編號 : N/A
Priority Application Number:
- [340] 聲稱具有優先權 (部分) : N/A
Priority Claim Details:
- [330] 優先權申請的
國家、地區、地方 : N/A

Country, territory, area of
Priority Applications:

[210] 商標申請編號 : 305850487

Application No.:

[540] 商標 : A

Mark:



B

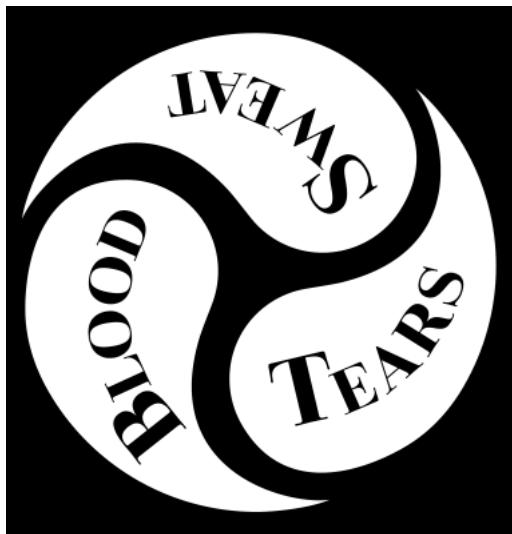

[550] 商標種類 : Ordinary

Mark Type:

一系列商標 : YES

Series Mark:

[571] 商標描述 : N/A

Mark Description:

[730] 註冊申請人的姓名 / 名稱、地址 :
Applicant(s) ' Name,Address: BST INTERNATIONAL COMPANY LIMITED
ROOM 16, BLOCK K, 20/F., TELFORD GARDEN
KOWLOON BAY, KOWLOON
HONG KONG

[740/ 註冊申請人的送達地址 :
750] Applicant's Address for Service: HONG KONG INTELLECTUAL PROPERTY ADVISORY
SERVICE LIMITED
1/F., FUK WO INDUSTRIAL BUILDING

5 SHEUNG HEI STREET, SAN PO KONG, KOWLOON
HONG KONG

- [511] 類別編號 : 28, 35, 41
Class(es) No(s) .:
- [511] 貨品 / 服務說明 :
Specification: Class 41:
Fitness training services; advisory services relating to physical fitness training; conducting fitness classes; personal physical fitness training services; physical fitness center services (exercises); physical fitness club services; physical fitness education services; physical fitness instruction; physical fitness training; physical fitness training consultation; provision of fitness facilities; rental of fitness apparatus; teaching relating to physical fitness; education; providing of training; sporting and cultural activities.
- [526] 卸棄 :
Disclaimer: N/A
- [529] 限制 :
Limitation: N/A
- [527] 條件 :
Condition: N/A
- 其他 :
Others: N/A
- [220] 提交日期 : 12-01-2022
Date of Filing:
- [320] 聲稱具有優先權的日期 : N/A
Date of Priority Claimed:
- [310] 優先權申請編號 : N/A
Priority Application Number:
- [340] 聲稱具有優先權 (部分) : N/A
Priority Claim Details:
- [330] 優先權申請的
國家、地區、地方 : N/A
Country, territory, area of
Priority Applications:
-
-

- [210] 商標申請編號 : 305850612
Application No.:
- [540] 商標 :
Mark:

LÜRSEN
乐顺游艇

- [550] 商標種類 : Ordinary

Mark Type:

一 系列商標 : NO
Series Mark:

[571] 商標描述 : N/A
Mark Description:

[730] 註冊申請人的姓名 / 名稱、地址 : FR.LUERSSEN WERFT GMBH & CO.KG
Applicant(s) ' ZUM ALTEN
Name, Address: SPEICHER 11 28759 BREMEN,
GERMANY

[740/ 註冊申請人的送達地址 : UNITALEN ATTORNEYS AT LAW LIMITED
750] Applicant's Address for RM 1201, 12/F, GOLDEN ERA PLAZA,
Service: 39-55 SAI YEE ST, MONGKOK KLN,
HONG KONG

[511] 類別編號 : 12, 37, 41, 42
Class(es) No(s) .:

[511] 貨品 / 服務說明 : Class 41:
Specification: Arranging and conducting of workshops
[training].

[526] 卸棄 : N/A
Disclaimer:

[529] 限制 : N/A
Limitation:

[527] 條件 : N/A
Condition:
其他 : N/A
Others

[220] 提交日期 : 05-01-2022
Date of Filing:

[320] 聲稱具有優先權的日期 : N/A
Date of Priority Claimed:

[310] 優先權申請編號 : N/A
Priority Application Number:

[340] 聲稱具有優先權 (部分) : N/A
Priority Claim Details:

[330] 優先權申請的 : N/A
國家、地區、地方 :
Country, territory, area of
Priority Applications:

[210] 商標申請編號 : 305851279
Application No.:

[540] 商標：
Mark:



- [550] 商標種類：一般商標
Mark Type:
一系列商標：否
Series Mark:
- [571] 商標描述：申請人聲稱黑色為商標的一個要素。
Mark Description:
- [730] 註冊申請人的姓名 / 名稱、地址：CFCA CHOCOLATE TALENT LIMITED
Applicant(s) ' 香港
Name, Address: 九龍旺角亞皆老街 98 號
富都大廈 2 樓 22 室
- [740/ 註冊申請人的送達地址：CFCA CHOCOLATE TALENT LIMITED
750] Applicant's Address for 香港
Service: 九龍旺角亞皆老街 98 號
富都大廈 2 樓 22 室
- [511] 類別編號：41
Class(es) No(s) .:
- [511] 貨品 / 服務說明：類別 41：
Specification: 安排在教育機構中進行的培訓課程；廣告、推銷、市場營銷和商業戰略規劃的培訓課程；美容藝術指導；設計方面的培訓；學校（教育）；函授課程；體育教育；教學；教育；培訓；提供教育信息；教育考核；幼兒園；實際培訓（示範）；就業指導（教育或培訓顧問）；輔導（培訓）；職業再培訓；學校教育服務；茶道訓練（茶藝訓練）；傳授技術（培訓）；組織教育或娛樂競賽；安排和組織學術討論會；安排和組織會議；安排和組織大會；組織文化或教育展覽；組織體育比賽；安排和組織專家討論會；安排和組織專題研討會；安排和組織培訓班；安排和組織現場教育論壇；關於培訓、科學、公共法律和社會事務的文件出版；目錄出版；小冊子出版；文字出版（廣告宣傳文本除外）；書籍出版；電子書籍和雜誌的在線出版；電子桌面排版；提供不可下載的在線電子出版物；除廣告以外的版面設計；提供不可下載在線視頻；為活動提供視頻編輯服務；為娛樂或文化目的提供用戶評價；為娛樂或文化目的提供用戶排名；為娛樂或文化目的提供用戶評級；公園；植物園；植物展覽；畫展服務；藝術展覽；

- [526] 卸棄: 不適用
Disclaimer:
- [529] 限制: 不適用
Limitation:
- [527] 條件: 不適用
Condition:
其他: 不適用
Others
- [220] 提交日期: 06-01-2022
Date of Filing:
- [320] 聲稱具有優先權的日期: 不適用
Date of Priority Claimed:
- [310] 優先權申請編號: 不適用
Priority Application Number:
- [340] 聲稱具有優先權 (部分): 不適用
Priority Claim Details:
- [330] 優先權申請的 不適用
國家、地區、地方:
Country, territory, area of
Priority Applications:
-
-

- [210] 商標申請編號: 305851756
Application No.:
- [540] 商標: A
Mark:



SANDYY
一葉

B



SANDYY

一葉

- [550] 商標種類 : Ordinary
 Mark Type:
 一系列商標 : YES
 Series Mark:
- [571] 商標描述 : The applicant claims the colours green and silver as elements of mark "B" in the series.
 Mark Description:
- [730] 註冊申請人的姓名 / 名稱、地址 : Sandy Biotechnology Group Co., Limited
 Applicant(s) ' Flat/Rm 229, Block 12W Phase 3
 Name,Address: Hong Kong Science Park, Shatin, NT
 HONG KONG
- [740/ 註冊申請人的送達地址 : RIGHT IP LIMITED
 750] Applicant's Address for 2002 Jupiter Tower
 Service: 9 Jupiter Street
 HONG KONG
- [511] 類別編號 : 41
 Class(es) No(s) .:
- [511] 貨品 / 服務說明 : Class 41:
 Specification: Arranging and conducting of conferences, congresses, educational exhibitions, seminars, symposiums, workshops, educational events, competitions and contests; business training in the fields of sales, business operations, productivity, goal tracking and customer acquisition; club services (entertainment or education); education; entertainment; healthy clubs services (health and physical training); mobile libraries; modeling for artists; planning, organising and managing congresses, conferences, colloquiums, symposiums, seminars, lectures, talks and workshops; practical training (demonstration); providing of training; providing online electronic publications (non-downloadable); providing online videos (non-downloadable); sporting and cultural activities; workshops and seminars in the fields of beauty and essential oils.
- [526] 卸棄 : N/A
 Disclaimer:

[529] 限制 : N/A
Limitation:

[527] 條件 : N/A
Condition:
其他 : N/A
Others

[220] 提交日期 : 06-01-2022
Date of Filing:

[320] 聲稱具有優先權的日期 : N/A
Date of Priority Claimed:

[310] 優先權申請編號 : N/A
Priority Application Number:

[340] 聲稱具有優先權 (部分) : N/A
Priority Claim Details:

[330] 優先權申請的
國家、地區、地方 : N/A
Country, territory, area of
Priority Applications:

[210] 商標申請編號 : 305851783
Application No.:

[540] 商標 : A
Mark:



LifeHikes

B



LifeHikes

[550] 商標種類 : Ordinary
Mark Type:
一系列商標 : YES
Series Mark:

[571] 商標描述 : The applicant claims the colours greenish
Mark Description: blue, sky blue, royal blue and grey as
elements of mark "B" in the series.

[730] 註冊申請人的姓名 / 名稱、地址 : Blue Planet Training, Inc.
Applicant(s) ' 248 Lorraine Avenue, Second Floor,
Name, Address: Montclair, New Jersey 07043,
UNITED STATES OF AMERICA

[740/ 註冊申請人的送達地址 : INCOMPASS IP LIMITED
750] Applicant's Address for Unit 205, 2/F, Building 19W, 19 Science Park
Service: West Avenue,
Hong Kong Science Park, Pak Shek Kok,
HONG KONG

[511] 類別編號 : 9, 41, 42
Class(es) No(s) .:

[511] 貨品 / 服務說明 : Specification:	Class 41: Educational services in the nature of interactive seminars about public speaking; arranging and conducting of instructional courses, computer training, correspondence courses, conferences, workshops, seminars, webinars in the fields of business, career, leadership, sales and communications skills and business strategy development; business education, coaching and training services, namely, developing customized leadership and executive development programs, providing executive coaching services, providing online and in-person courses of instruction to employees and executives, providing public and in-company seminars, conferences and symposiums to business leaders, and providing virtual and in-company training programs for development of presentation, communication, sales, leadership, management, customer service, and meeting facilitation skills; providing on-line training courses and workshops in the field of developing presentation, communication, sales, leadership, management, customer service, and meeting facilitation skills, and distribution of course and educational materials in connection therewith; providing individual and group coaching in the field of developing presentation, communication, sales, leadership, management, customer service, and meeting facilitation skills.
[526] 卸棄 : Disclaimer:	N/A
[529] 限制 : Limitation:	N/A
[527] 條件 : Condition: 其他 : Others	N/A N/A
[220] 提交日期 : Date of Filing:	06-01-2022
[320] 聲稱具有優先權的日期 : Date of Priority Claimed:	N/A
[310] 優先權申請編號 : Priority Application Number:	N/A
[340] 聲稱具有優先權 (部分) : Priority Claim Details:	N/A
[330] 優先權申請的 國家、地區、地方 : Country, territory, area of Priority Applications:	N/A

[210] 商標申請編號 : 305852359

Application No.:

[540] 商標 :

Mark:

閃避城

[550] 商標種類 : Ordinary

Mark Type:

一系列商標 :

NO

Series Mark:

[571] 商標描述 : N/A

Mark Description:

[730] 註冊申請人的姓名 / 名稱、地址 :

DODGE CITY LIMITED

Applicant(s) ' Name,Address:

111/F., CAPITAL CENTRE

151 GLOUCESTER ROAD, WAN CHAI

HONG KONG

[740/ 註冊申請人的送達地址 :

FERRANTE LIMITED

750] Applicant's Address for

Level 16, Nexxus Building

Service:

41 Connaught Road Central, Central

HONG KONG

[511] 類別編號 :

28,41

Class(es) No(s) .:

[511] 貨品 / 服務說明 :

Class 41:

Specification:

Physical education;Organization of sports competitions; Lending library services;Online publication of electronic books and journals;Distribution of video tapes;Rental of cinematographic apparatus; Amusement park services;Providing sports facilities;Toy rental; Games equipment rental; Conducting guided tours;Providing museum facilities [presentation, exhibitions]; Zoological garden services;Modelling for artists;Organization of lotteries;Rental of indoor aquaria.

[526] 卸棄 :

N/A

Disclaimer:

[529] 限制 :

N/A

Limitation:

[527] 條件 :

N/A

Condition:

其他 :

N/A

Others

[220] 提交日期 :

07-01-2022

Date of Filing:

[320] 聲稱具有優先權的日期 :

N/A

Date of Priority Claimed:

[310] 優先權申請編號: N/A

Priority Application Number:

[340] 聲稱具有優先權 (部分): N/A

Priority Claim Details:

[330] 優先權申請的 N/A

國家、地區、地方:

Country, territory, area of

Priority Applications:

[210] 商標申請編號: 305852368

Application No.:

[540] 商標:

Mark:

DODGE CITY

[550] 商標種類: Ordinary

Mark Type:

一系列商標:

NO

Series Mark:

[571] 商標描述: N/A

Mark Description:

[730] 註冊申請人的姓名/名稱、地址:

DODGE CITY LIMITED

Applicant(s)'

111/F., CAPITAL CENTRE

Name, Address:

151 GLOUCESTER ROAD, WAN CHAI

HONG KONG

[740/ 註冊申請人的送達地址:

FERRANTE LIMITED

750] Applicant's Address for

Level 16, Nexxus Building

Service:

41 Connaught Road Central, Central

HONG KONG

[511] 類別編號: 28, 41

Class(es) No(s) .:

[511] 貨品/服務說明:

Class 41:

Specification:

Physical education; Organization of sports competitions; Lending library services; Online publication of electronic books and journals; Distribution of video tapes; Rental of cinematographic apparatus; Amusement park services; Providing sports facilities; Toy rental; Games equipment rental; Conducting guided tours; Providing museum facilities [presentation, exhibitions]; Zoological garden services; Modelling for artists; Organization of lotteries; Rental of indoor aquaria.

[526] 卸棄: N/A

Disclaimer:

[529] 限制: N/A

Limitation:

[527] 條件 : N/A
Condition:
其他 : N/A
Others

[220] 提交日期 : 07-01-2022
Date of Filing:

[320] 聲稱具有優先權的日期 : N/A
Date of Priority Claimed:

[310] 優先權申請編號 : N/A
Priority Application Number:

[340] 聲稱具有優先權 (部分) : N/A
Priority Claim Details:

[330] 優先權申請的
國家、地區、地方 : N/A
Country, territory, area of
Priority Applications:

[210] 商標申請編號 : 305852395
Application No.:

[540] 商標 :
Mark:

BITSKI

[550] 商標種類 : Ordinary
Mark Type:
一系列商標 : NO
Series Mark:

[571] 商標描述 : N/A
Mark Description:

[730] 註冊申請人的姓名 / 名稱、地址 : Bitski, Inc.
Applicant(s) ' 77 Van Ness Avenue, Suite 101
Name, Address: San Francisco, CA 94102
UNITED STATES OF AMERICA

[740/ 註冊申請人的送達地址 :
750] Applicant's Address for 19TH FLOOR, THREE EXCHANGE SQUARE,
Service: 8 CONNAUGHT PLACE, CENTRAL,
HONG KONG

[511] 類別編號 : 9, 41, 42
Class(es) No(s) .:

[511] 貨品 / 服務說明 : Class 41:
Specification: Education and entertainment services;
Entertainment services, namely, providing an
online virtual environment for creating,
selling, buying, trading, owing, and storing
non-fungible tokens (NFTs), digital media,
digital goods, and data; Providing
entertainment information in the fields of
art, non-fungible tokens (NFTs), and digital

media via a website; Providing information in the field of art; Providing on-line art exhibitions.

- [526] 卸棄: N/A
Disclaimer:
- [529] 限制: N/A
Limitation:
- [527] 條件: N/A
Condition:
其他: N/A
Others
- [220] 提交日期: 07-01-2022
Date of Filing:
- [320] 聲稱具有優先權的日期: 10-07-2021
Date of Priority Claimed:
- [310] 優先權申請編號: 90821251
Priority Application Number:
- [340] 聲稱具有優先權 (部分): N/A
Priority Claim Details:
- [330] 優先權申請的
國家、地區、地方: UNITED STATES OF AMERICA
Country, territory, area of
Priority Applications:
-
-

- [210] 商標申請編號: 305852430
Application No.:
- [540] 商標: A
Mark:

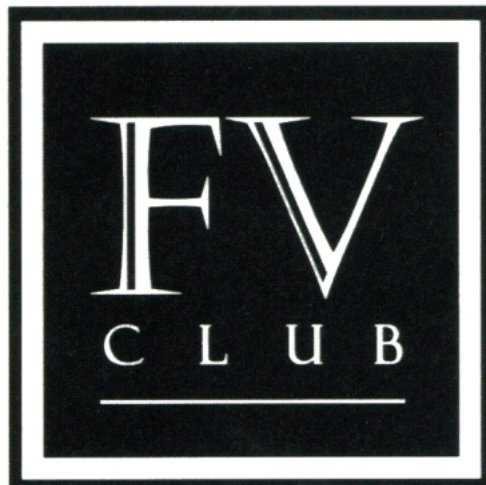

B



- [550] 商標種類 : Ordinary
 Mark Type:
 一系列商標 : YES
 Series Mark:
- [571] 商標描述 : The applicant claims the colour gold as an
 Mark Description: element of mark "B" in the series.
- [730] 註冊申請人的姓名 / 名稱、地址 : F. V. CLUB HOUSE LIMITED (早禾居會所有限公司)
 Applicant(s) ' 15th Floor, TS Tower
 Name,Address: 43 Heung Yip Road, Wong Chuk Hang,
 HONG KONG
- [740/ 註冊申請人的送達地址 : F. V. CLUB HOUSE LIMITED (早禾居會所有限公司)
 750] Applicant's Address for 15th Floor, TS Tower,
 Service: 43 Heung Yip Road Wong Chuk Hang
 HONG KONG
- [511] 類別編號 : 28, 35, 36, 37, 41, 43
 Class(es) No(s) .:
- [511] 貨品 / 服務說明 : Class 41:
 Specification: Providing of training; entertainment; sporting
 and cultural activities
- [526] 卸棄 : N/A
 Disclaimer:
- [529] 限制 : N/A
 Limitation:
- [527] 條件 : N/A
 Condition:
 其他 : N/A
 Others
- [220] 提交日期 : 07-01-2022
 Date of Filing:
- [320] 聲稱具有優先權的日期 : N/A
 Date of Priority Claimed:
- [310] 優先權申請編號 : N/A
 Priority Application Number:
- [340] 聲稱具有優先權 (部分) : N/A
 Priority Claim Details:

[330] 優先權申請的 N/A

國家、地區、地方:

Country, territory, area of

Priority Applications:

[210] 商標申請編號: 305852458

Application No.:

[540] 商標: A

Mark:



B



[550] 商標種類: Ordinary

Mark Type:

一系列商標: YES

Series Mark:

[571] 商標描述: The applicant claims the colours red and yellow as elements of Mark "B" in the series.
Mark Description:

[730] 註冊申請人的姓名 / 名稱、地址: Supreme Property Management Limited
Applicant(s) ' Unit 26, 2/F, Block A, Hoi Luen Industrial
Name, Address: Centre,

55 Hoi Yuen Road, Kwun Tong,
HONG KONG

[740/ 註冊申請人的送達地址: RIGHT IP LIMITED

750] Applicant's Address for 2002 Jupiter Tower

Service: 9 Jupiter Street

HONG KONG

- [511] 類別編號 : 16, 35, 36, 37, 41, 42
Class(es) No(s) .:
- [511] 貨品 / 服務說明 :
Specification: Class 41:
Arranging and conducting of conferences, congresses, exhibitions, seminars, symposiums, workshops, events, competitions and contests; arranging and organizing of group recreation activities; career counselling [education and training advice]; club services (entertainment or education); coaching [training]; commercial and business training services; design of educational courses, examinations and qualifications; education; entertainment; planning, organising and managing congresses, conferences, colloquiums, symposiums, seminars, lectures, talks and workshops; providing entertainment facilities; providing facilities for movies, shows, plays, music or educational training; providing non-downloadable electronic publications, books, videos, films and shows; providing of training relating to surveying, real estate investment and financial investment; providing recreation facilities; provision of training courses relating to business management, business administration and business operation; publication of printer matter, books, documentations, videos, films and shows; sporting and cultural activities; theme park services; training services; provision of information, advisory and consultancy services relating to the aforesaid services.
- [526] 卸棄 : N/A
Disclaimer:
- [529] 限制 : N/A
Limitation:
- [527] 條件 : N/A
Condition:
其他 : N/A
Others
- [220] 提交日期 : 07-01-2022
Date of Filing:
- [320] 聲稱具有優先權的日期 : N/A
Date of Priority Claimed:
- [310] 優先權申請編號 : N/A
Priority Application Number:
- [340] 聲稱具有優先權 (部分) : N/A
Priority Claim Details:
- [330] 優先權申請的
國家、地區、地方 : N/A
Country, territory, area of
Priority Applications:

[210] 商標申請編號 : 305852548

Application No.:

[540] 商標 :

Mark:

Akashic Healing



[550] 商標種類 : 一般商標

Mark Type:

一系列商標 :

否

Series Mark:

[571] 商標描述 : 不適用

Mark Description:

[730] 註冊申請人的姓名 / 名稱、地址 :

TAI SHUK YI

Applicant(s) '

香港

Name, Address:

黃竹坑業勤街 33-35 號

金來工業大廈 2 期 18 樓 E 室

[740/ 註冊申請人的送達地址 :

戴淑儀

750] Applicant's Address for

香港

Service:

黃竹坑業興街 11 號

南匯廣場 B 座 6 樓 607-608 室

[511] 類別編號 : 16, 41, 45

Class(es) No(s) .:

[511] 貨品 / 服務說明 :

類別 41:

Specification:

出版, 休閒中心服務; 安排及舉行會議、議會、展覽、研討會、專題研討會、工作坊、演出項目、比賽及競技比賽; 為藝術家提供模特服務; 計劃、組織和管理議會、會議、討論會、專題研討會、研討會、講座、演講及工作坊; 娛樂、運動及文化活動, 健身俱樂部; 教育及培訓服務, 教學及補習服務, 設計教學課程, 考試及資歷架構; 提供及出租設施及設備作教育、娛樂、文化、文娛及體育之用途; 提供有關教育、娛樂、文化及體育之資訊、諮詢及顧問服務; 電子刊物、書刊、雜誌及期刊的出版; 製作及發行影片、廣播及電視節目、電影、報紙、影音節目及音樂唱片; 藝術展覽服務, 攝影及數碼攝影

[526] 卸棄 : 不適用

Disclaimer:

[529] 限制 : 不適用

Limitation:

[527] 條件 : 不適用

Condition:

其他 :

不適用

Others

[220] 提交日期: 07-01-2022
Date of Filing:
[320] 聲稱具有優先權的日期: 不適用
Date of Priority Claimed:
[310] 優先權申請編號: 不適用
Priority Application Number:
[340] 聲稱具有優先權 (部分): 不適用
Priority Claim Details:
[330] 優先權申請的 不適用
國家、地區、地方:
Country, territory, area of
Priority Applications:

[210] 商標申請編號: 305852773
Application No.:

[540] 商標:
Mark:

A



B



[550] 商標種類: 一般商標
Mark Type:
一系列商標: 是
Series Mark:

[571] 商標描述: 在本系列商標中的商標"A", 申請人聲稱橘黃色及深藍色為商標的多於一個要素。
Mark Description:

[730] 註冊申請人的姓名 / 名稱、地址: HONG KONG PRESSPLAY LIMITED
Applicant(s) ' 香港
Name, Address: 九龍尖沙咀科學館道 1 號

[740/ 註冊申請人的送達地址: HONG KONG PRESSPLAY LIMITED
750] Applicant's Address for 香港
Service: 九龍尖沙咀科學館道 1 號

[511] 類別編號: 9, 35, 38, 41, 42
Class(es) No(s) .:

[511] 貨品 / 服務說明: 類別 41:
Specification: 電子書籍及期刊之線上出版; 提供電子刊物線上瀏覽服務; 提供不可下載之線上電子刊物; 提供電子圖片線上瀏覽服務; 文字撰寫 (廣告稿除外); 培訓服務; 輔導 (訓練); 藉由模擬訓練裝置提供培訓服務; 教育訓練; 對個人之技能與學術能力程度做甄別及檢定; 教育考試; 技能檢定; 職業訓練; 職業再培訓; 娛樂服務; 提供線上影片欣賞服務; 提供不可下載之線上錄影節目; 藉由隨選視訊提供不可下載之影片; 提供線上音樂欣

賞服務；提供不可下載之線上音樂；影片製作；除廣告片外的影片製作；影片發行；表演節目製作；現場表演；藝人表演服務；全部包括於類別 41。

- [526] 卸棄： 不適用
Disclaimer:
- [529] 限制： 不適用
Limitation:
- [527] 條件： 不適用
Condition:
其他： 不適用
Others
- [220] 提交日期： 07-01-2022
Date of Filing:
- [320] 聲稱具有優先權的日期： 不適用
Date of Priority Claimed:
- [310] 優先權申請編號： 不適用
Priority Application Number:
- [340] 聲稱具有優先權 (部分)： 不適用
Priority Claim Details:
- [330] 優先權申請的 不適用
國家、地區、地方：
Country, territory, area of
Priority Applications:

-
- [210] 商標申請編號： 305852809
Application No.:
- [540] 商標： A
Mark:



B



- [550] 商標種類： 一般商標
Mark Type:
- 一系列商標： 是
Series Mark:
- [571] 商標描述： 在本系列商標中的商標"A"，申請人聲稱橘黃色為商標的一個要素。
Mark Description:
- [730] 註冊申請人的姓名 / 名稱、地址： HONG KONG PRESSPLAY LIMITED
Applicant(s) ' 香港
Name, Address: 九龍尖沙咀科學館道 1 號
康宏廣場 25 樓 9 室
- [740/ 註冊申請人的送達地址： HONG KONG PRESSPLAY LIMITED
750] Applicant's Address for 香港
Service: 九龍尖沙咀科學館道 1 號
康宏廣場 25 樓 9 室
- [511] 類別編號： 9, 35, 38, 41
Class(es) No(s) .:
- [511] 貨品 / 服務說明： 類別 41：
Specification: 電子書籍及期刊之線上出版；提供電子刊物線上瀏覽服務；提供不可下載之線上電子刊物；提供電子圖片線上瀏覽服務；文字撰寫 (廣告稿除外)；培訓服務；輔導 (訓練)；藉由模擬訓練裝置提供培訓服務；教育訓練；對個人之技能與學術能力程度做甄別及檢定；教育考試；技能檢定；職業訓練；職業再培訓；娛樂服務；提供線上影片欣賞服務；提供不可下載之線上錄影節目；藉由隨選視訊提供不可下載之影片；提供線上音樂欣賞服務；提供不可下載之線上音樂；影片製作；除廣告片外的影片製作；影片發行；表演節目製作；現場表演；藝人表演服務；全部包括於類別 41。
- [526] 卸棄： 不適用
Disclaimer:
- [529] 限制： 不適用
Limitation:
- [527] 條件： 不適用
Condition:
- 其他： 不適用
Others

[220] 提交日期 : 07-01-2022
Date of Filing:

[320] 聲稱具有優先權的日期 : 不適用
Date of Priority Claimed:

[310] 優先權申請編號 : 不適用
Priority Application Number:

[340] 聲稱具有優先權 (部分) : 不適用
Priority Claim Details:

[330] 優先權申請的
國家、地區、地方 : 不適用
Country, territory, area of
Priority Applications:

[210] 商標申請編號 : 305852818
Application No.:

[540] 商標 :
Mark:



[550] 商標種類 : 一般商標
Mark Type:
一系列商標 : 是
Series Mark:

[571] 商標描述 : 在本系列商標中的商標"A", 申請人聲稱橘黃色及深藍色為商標的多於一個要素。
Mark Description:

[730] 註冊申請人的姓名 / 名稱、地址 : HONG KONG PRESSPLAY LIMITED
Applicant(s) ' Name, Address: 香港

[740/ 註冊申請人的送達地址 : HONG KONG PRESSPLAY LIMITED
750] Applicant's Address for Service: 香港
九龍尖沙咀科學館道 1 號
康宏廣場 25 樓 9 室

[511] 類別編號 : 9, 35, 38, 41
Class(es) No(s) .:

[511] 貨品 / 服務說明 : 類別 41:
Specification: 電子書籍及期刊之線上出版; 提供電子刊物線上瀏覽服務; 提供不可下載之線上電子刊物; 提供電子圖片線上瀏覽服務; 文字撰寫 (廣告稿除外); 培訓服務; 輔導 (訓練); 藉由模擬訓練裝置提供培訓服務; 教育訓練; 對個人之技能與學術能力程度做甄別及檢定; 教育考試; 技能檢定; 職業訓練; 職業再培訓; 娛樂服務; 提供線上影片欣賞服務; 提供不可下載之線上錄

影節目；藉由隨選視訊提供不可下載之影片；提供線上音樂欣賞服務；提供不可下載之線上音樂；影片製作；除廣告片外的影片製作；影片發行；表演節目製作；現場表演；藝人表演服務；全部包括於類別 41。

[526] 卸棄：	不適用
Disclaimer:	
[529] 限制：	不適用
Limitation:	
[527] 條件：	不適用
Condition:	
其他：	不適用
Others	
[220] 提交日期：	07-01-2022
Date of Filing:	
[320] 聲稱具有優先權的日期：	不適用
Date of Priority Claimed:	
[310] 優先權申請編號：	不適用
Priority Application Number:	
[340] 聲稱具有優先權 (部分)：	不適用
Priority Claim Details:	
[330] 優先權申請的	不適用
國家、地區、地方：	
Country, territory, area of	
Priority Applications:	

[210] 商標申請編號： 305852863
Application No.:

[540] 商標：
Mark:

SUNDAY RILEY

[550] 商標種類： Ordinary
Mark Type:

一系列商標： NO

Series Mark:

[571] 商標描述： N/A

Mark Description:

[730] 註冊申請人的姓名 / 名稱、地址： Sunday Riley Modern Skincare, LLC
Applicant(s) ' 4444 Westheimer Rd, Suite G305
Name, Address: Houston, Texas 77027

UNITED STATES OF AMERICA

[740/ 註冊申請人的送達地址：
750] Applicant's Address for
Service:

BIRD & BIRD
6/F, The Annex, Central Plaza
18 Harbour Road
HONG KONG

[511] 類別編號： 3, 5, 41, 44
Class(es) No(s) .:

[511] 貨品 / 服務說明 :	Class 41:
Specification:	Education; providing of training; entertainment; sporting and cultural activities; arranging, conducting and organising conferences, exhibitions, events, courses, tutorials and award ceremonies; provision of electronic publications, including online magazines, periodicals and newsletters, accessible via databases and the Internet; providing instruction in the field of beauty, cosmetics, nutrition and health; workshops, seminars, retreats (training), training courses and camps (training) in the field of beauty, cosmetics, nutrition and health; conducting training courses relating to beauty, cosmetics, nutrition, health; teaching of beauty and skincare skills; educational services relating to beauty therapy; provision of non-downloadable video/audio content, videos and publications all via a website; providing on-line newsletters; conducting on-line educational programs; writing services for blogs; photographic reporting; publication of texts, illustrations, calendars of events, schedules, books, magazines, newspapers, periodicals and more generally all types of publication, including electronic and digital publishing; news reporter services; information, advisory and consultancy services in relation to the aforesaid services.
[526] 卸棄 :	N/A
Disclaimer:	
[529] 限制 :	N/A
Limitation:	
[527] 條件 :	N/A
Condition:	
其他 :	N/A
Others	
[220] 提交日期 :	07-01-2022
Date of Filing:	
[320] 聲稱具有優先權的日期 :	N/A
Date of Priority Claimed:	
[310] 優先權申請編號 :	N/A
Priority Application Number:	
[340] 聲稱具有優先權 (部分) :	N/A
Priority Claim Details:	
[330] 優先權申請的	N/A
國家、地區、地方 :	
Country, territory, area of	
Priority Applications:	

[210] 商標申請編號 : 305853349
Application No.:

[540] 商標 : A
Mark:



B



[550] 商標種類 : Ordinary
Mark Type:

一系列商標 : YES

Series Mark:

[571] 商標描述 : N/A

Mark Description:

[730] 註冊申請人的姓名 / 名稱、地址 : TABLE FOR CHOICES LIMITED (香港劇場社有限公司)
Applicant(s) ' 6/F., BLOCK C, CHEONG FAT FACTORY BUILDING,
Name,Address: 265-271 UN CHAU STREET, CHEUNG SHA WAN, KL.,
HONG KONG

[740/ 註冊申請人的送達地址 : ACCOLADE IP LIMITED

750] Applicant's Address for 10/F, Fu Fai Comm. Ctr.,
Service: 27 Hillier Street, Sheung Wan,
HONG KONG

[511] 類別編號 : 41
Class(es) No(s) .:

[511] 貨品 / 服務說明 :
Specification: Class 41:
Education; providing of training;
entertainment; sporting and cultural
activities; providing courses relating to
certificate of board games; providing
trainings for certificate of board game
mentor.

[526] 卸棄 :
Disclaimer: N/A

[529] 限制 :
Limitation: N/A

[527] 條件 :
Condition: N/A
其他 :
Others N/A

[220] 提交日期 :
Date of Filing: 07-01-2022

[320] 聲稱具有優先權的日期 :
Date of Priority Claimed: N/A

[310] 優先權申請編號 :
Priority Application Number: N/A

[340] 聲稱具有優先權 (部分) :
Priority Claim Details: N/A

[330] 優先權申請的
國家、地區、地方 :
Country, territory, area of
Priority Applications: N/A

[210] 商標申請編號 :
Application No.: 305853420

[540] 商標 :
Mark: RIFT RUMBLE SERIES

[550] 商標種類 :
Mark Type: Ordinary
一系列商標 :
Series Mark: NO

[571] 商標描述 :
Mark Description: N/A

[730] 註冊申請人的姓名 / 名稱、地址 :
Applicant(s) ' Riot Games, Inc.
Name,Address: 12333 W. Olympic Blvd.
Los Angeles, California 90064
UNITED STATES OF AMERICA

[740/ 註冊申請人的送達地址 :
750] Applicant's Address for BIRD & BIRD
Service: 6/F, The Annex, Central Plaza

18 Harbour Road
HONG KONG

- [511] 類別編號 : 25,38,41
Class(es) No(s) .:
- [511] 貨品 / 服務說明 :
Specification:
- Class 41:
Entertainment services; Entertainment services, namely, arranging and conducting live computer and video game competitions and tournaments; establishing rules and regulations in connection with computer and video gaming competitions and tournaments; providing non-downloadable audio and video presentations in the fields of computer and video game competitions and tournaments via a website; providing non-downloadable entertainment information about computer and video game competitions and tournaments via a website; entertainment services, namely, organizing live fan meetings and conferences with interactive gameplay between participants in the fields of computer and video games.
- [526] 卸棄 : N/A
Disclaimer:
- [529] 限制 : N/A
Limitation:
- [527] 條件 : N/A
Condition:
- 其他 : N/A
Others
- [220] 提交日期 : 07-01-2022
Date of Filing:
- [320] 聲稱具有優先權的日期 : N/A
Date of Priority Claimed:
- [310] 優先權申請編號 : N/A
Priority Application Number:
- [340] 聲稱具有優先權 (部分) : N/A
Priority Claim Details:
- [330] 優先權申請的
國家、地區、地方 : N/A
Country, territory, area of
Priority Applications:
-
-

- [210] 商標申請編號 : 305853439
Application No.:

- [540] 商標 : **WILD RIFT ICONS GLOBAL CHAMPIONSHIP**

Mark:

- [550] 商標種類: Ordinary
Mark Type:
一系列商標: NO
Series Mark:
- [571] 商標描述: N/A
Mark Description:
- [730] 註冊申請人的姓名 / 名稱、地址: Riot Games, Inc.
Applicant(s) ' 12333 W. Olympic Blvd.
Name,Address: Los Angeles, California 90064
UNITED STATES OF AMERICA
- [740/ 註冊申請人的送達地址: BIRD & BIRD
750] Applicant's Address for 6/F, The Annex, Central Plaza
Service: 18 Harbour Road
HONG KONG
- [511] 類別編號: 25,38,41
Class(es) No(s) .:
- [511] 貨品 / 服務說明: Class 41:
Specification: Entertainment services; Entertainment services, namely, arranging and conducting live computer and video game competitions and tournaments; establishing rules and regulations in connection with computer and video gaming competitions and tournaments; providing non-downloadable audio and video presentations in the fields of computer and video game competitions and tournaments via a website; providing non-downloadable entertainment information about computer and video game competitions and tournaments via a website; entertainment services, namely, organizing live fan meetings and conferences with interactive gameplay between participants in the fields of computer and video games.
- [526] 卸棄: N/A
Disclaimer:
- [529] 限制: N/A
Limitation:
- [527] 條件: N/A
Condition:
其他: N/A
Others
- [220] 提交日期: 07-01-2022
Date of Filing:
- [320] 聲稱具有優先權的日期: N/A
Date of Priority Claimed:
- [310] 優先權申請編號: N/A
Priority Application Number:
- [340] 聲稱具有優先權 (部分): N/A
Priority Claim Details:

[330] 優先權申請的 N/A
國家、地區、地方：
Country, territory, area of
Priority Applications:

[210] 商標申請編號： 305853448
Application No.:

[540] 商標：
Mark: **PACIFIC RIFT RUMBLE**

[550] 商標種類： Ordinary
Mark Type:

一系列商標： NO

Series Mark:

[571] 商標描述： N/A

Mark Description:

[730] 註冊申請人的姓名 / 名稱、地址：
Applicant(s) ' Riot Games, Inc.
Name, Address: 12333 W. Olympic Blvd.
Los Angeles, California 90064
UNITED STATES OF AMERICA

[740/ 註冊申請人的送達地址：
750] Applicant's Address for BIRD & BIRD
Service: 6/F, The Annex, Central Plaza
18 Harbour Road
HONG KONG

[511] 類別編號： 25, 38, 41

Class(es) No(s).:

[511] 貨品 / 服務說明：
Specification: Class 41:
Entertainment services; Entertainment
services, namely, arranging and conducting
live computer and video game competitions and
tournaments; establishing rules and
regulations in connection with computer and
video gaming competitions and tournaments;
providing non-downloadable audio and video
presentations in the fields of computer and
video game competitions and tournaments via a
website; providing non-downloadable
entertainment information about computer and
video game competitions and tournaments via a
website; entertainment services, namely,
organizing live fan meetings and conferences
with interactive gameplay between participants
in the fields of computer and video games.

[526] 卸棄： N/A

Disclaimer:

[529] 限制： N/A

Limitation:

[527] 條件 : N/A
 Condition:
 其他 : N/A
 Others

[220] 提交日期 : 07-01-2022
 Date of Filing:

[320] 聲稱具有優先權的日期 : N/A
 Date of Priority Claimed:

[310] 優先權申請編號 : N/A
 Priority Application Number:

[340] 聲稱具有優先權 (部分) : N/A
 Priority Claim Details:

[330] 優先權申請的
 國家、地區、地方 : N/A
 Country, territory, area of
 Priority Applications:

[210] 商標申請編號 : 305853646
 Application No.:

[540] 商標 : A
 Mark:



B



[550] 商標種類 : Ordinary
 Mark Type:
 一系列商標 : YES
 Series Mark:

[571] 商標描述 : The applicant claims the colours gold and red
 Mark Description: as elements of mark "A" in the series.

[730] 註冊申請人的姓名 / 名稱、地址 : THE PROJECT FUTURUS LIMITED
 Applicant(s) ' G/F, HING YIP CTR,
 Name, Address: 72-76 TEXACO RD, TSUEN WAN NT,
 HONG KONG

[740/ 註冊申請人的送達地址 : CULTURE TECHNOLOGY LIMITED (Attn.: Ms. Elitor
 750] Applicant's Address for Wong)
 Service: 16TH FLOOR, V. HEUN BUILDING,
 NO.138 QUEEN'S ROAD, CENTRAL
 HONG KONG

[511] 類別編號 :	41
Class(es) No(s) .:	
[511] 貨品 / 服務說明 :	Class 41:
Specification:	Arranging and conducting of entertainment events; arranging and conducting of education events; arranging and conducting of seminars; arranging and conducting of training programs; organisation of parties; party planning; party planning for entertainment purposes; photography services; digital photography; electronic publishing services; publication services; publication of books, manuals and documentations; publication of electronic books and journals on-line; publication of journals; publication of leaflets; designing of training courses; conducting workshops [training].
[526] 卸棄 :	N/A
Disclaimer:	
[529] 限制 :	N/A
Limitation:	
[527] 條件 :	N/A
Condition:	
其他 :	N/A
Others	
[220] 提交日期 :	10-01-2022
Date of Filing:	
[320] 聲稱具有優先權的日期 :	N/A
Date of Priority Claimed:	
[310] 優先權申請編號 :	N/A
Priority Application Number:	
[340] 聲稱具有優先權 (部分) :	N/A
Priority Claim Details:	
[330] 優先權申請的	N/A
國家、地區、地方 :	
Country, territory, area of	
Priority Applications:	

[210] 商標申請編號 : 305853862
Application No.:

[540] 商標 : A
Mark:

嘉爾特

B

嘉尔特

[550] 商標種類:	Ordinary
Mark Type:	
一系列商標:	YES
Series Mark:	
[571] 商標描述:	N/A
Mark Description:	
[730] 註冊申請人的姓名 / 名稱、地址:	BALLET QUARTER HOLDINGS PTE. LTD.
Applicant(s) ' Name,Address:	6 BATTERY ROAD, #42-00 SINGAPORE 049909 SINGAPORE
[740/ 註冊申請人的送達地址:	KAIZEN IP AGENT LIMITED
750] Applicant's Address for Service:	Rooms 2103, Futura Plaza, 111 How Ming Street, Kwun Tong HONG KONG
[511] 類別編號:	9,15,16,25,28,35,38,41,42
Class(es) No(s) .:	
[511] 貨品 / 服務說明:	Class 41:
Specification:	Advisory services relating to education; Advisory services relating to entertainment; Arranging and conducting of concerts; Arranging and conducting of entertainment activities; Arranging exercise classes; Arranging of competitions; Arranging of exhibitions for educational purposes; Arranging of festivals; Arranging of musical events; Ballet shows; Boarding school education; Boarding school education consultancy; Career information and advisory services [educational and training advice]; Charitable services, namely education and training; Coaching services for sporting activities; Dance choreography; Dance instruction; Demonstration for instructional purposes; Design of educational courses; Dissemination of educational material; Dissemination of entertainment material; Distribution (other than transportation) of sound recordings; Distribution (other than transportation) of videos; Editing of audio recordings; Editing of photographs; Editing of video recordings; Education; Educational assessment services; Electronic publication of information on a wide range of topics, including online and over a global computer network; Entertainment, cultural or sporting event booking or reservation services provided in relation to a customer loyalty or frequent buyer scheme; Event management services [organization of educational, entertainment,

sporting or cultural events]; Fan club services [entertainment]; Fitness and exercise clinics, clubs and salons; Foreign language education services; Instruction in languages; Instruction in music; Instruction in physical fitness; Instruction in the field of performing arts; Instruction in the field of visual arts; Interactive online entertainment services; Music arranging services; Music composition services; Music publishing services; Music recording studio services; Music transcription services; Musical performance services; Organisation and conducting of dance, music and other entertainment festivals; Organisation of dancing events; Organisation of musical events; Organising events for cultural purposes; Organising of dancing competitions; Painting instruction; Preschool teaching; Primary education services; Production of audio and/or video recordings; Production of live performances; Providing dancing facilities; Providing facilities for educational purposes; Providing facilities for entertainment; Providing facilities for recreation; Providing information, including online, about education, training, entertainment, sporting and cultural activities; Providing online music, not downloadable; Providing online videos, not downloadable; Providing user ratings for entertainment or cultural purposes; Provision of educational examinations; Provision of entertainment, sporting or cultural services from customer loyalty and frequent buyer schemes; Provision of facilities for tuition; Provision of recording studio facilities; Publication of educational materials; Publication of electronic books and journals online; Publication of multimedia material online; Publication of posters; Publishing by electronic means; Publishing services; Rental of acoustic recording equipment; Rental of acoustic reproduction equipment; Rental of audio visual apparatus; Rental of musical instruments; Rental of musical instruments and equipment; Reservation services for concert tickets; Setting of educational standards; Setting of training standards; Staff training services; Teacher training services; Technological education services; Ticket agency services [entertainment]; Training; Tutoring; Vocational guidance [education or training advice].

[526] 卸棄 :

N/A

Disclaimer:

[529] 限制 : N/A
Limitation:

[527] 條件 : N/A
Condition:
其他 : N/A
Others

[220] 提交日期 : 10-01-2022
Date of Filing:

[320] 聲稱具有優先權的日期 : N/A
Date of Priority Claimed:

[310] 優先權申請編號 : N/A
Priority Application Number:

[340] 聲稱具有優先權 (部分) : N/A
Priority Claim Details:

[330] 優先權申請的
國家、地區、地方 : N/A
Country, territory, area of
Priority Applications:

[210] 商標申請編號 : 305854438
Application No.:

[540] 商標 :
Mark:



[550] 商標種類 : 一般商標
Mark Type:
一系列商標 : 否
Series Mark:

[571] 商標描述 : 不適用
Mark Description:

[730] 註冊申請人的姓名 / 名稱、地址 : 中國太平洋保險 (集團) 股份有限公司
Applicant (s) ' 中國
Name, Address: 上海市黃浦區
中山南路 1 號

[740/ 註冊申請人的送達地址 : 中港知識產權有限公司
750] Applicant's Address for 香港
Service: 灣仔告士打道 151 號
資本中心 15 樓 1502 室

[511] 類別編號 : 9, 36, 41
Class(es) No(s) .:

[511] 貨品 / 服務說明 : 類別 41:
Specification: 培訓 ; 安排和組織大會 ; 籌劃聚會 (娛樂) ; 健身俱樂部 (健身和體能訓練) ; 流動圖書館 ; 遊戲器具出租 ; 娛樂服務 ; 導遊服務 ; 組織娛樂活動 ; 組織小區教育活動 ; 提供不可下載的在線電子出版物。

[526] 卸棄 : 不適用
Disclaimer:

[529] 限制 : 不適用
Limitation:

[527] 條件 : 不適用
Condition:
其他 : 不適用
Others

[220] 提交日期 : 10-01-2022
Date of Filing:

[320] 聲稱具有優先權的日期 : 不適用
Date of Priority Claimed:

[310] 優先權申請編號 : 不適用
Priority Application Number:

[340] 聲稱具有優先權 (部分) : 不適用
Priority Claim Details:

[330] 優先權申請的 不適用
國家、地區、地方 :
Country, territory, area of
Priority Applications:

[210] 商標申請編號 : 305854447
Application No.:

[540] 商標：
Mark:



[550] 商標種類： 一般商標
Mark Type:
一系列商標： 否
Series Mark:

[571] 商標描述： 不適用
Mark Description:

[730] 註冊申請人的姓名 / 名稱、地址： 中國太平洋保險（集團）股份有限公司
Applicant(s) ' 中國
Name, Address: 上海市黃浦區
中山南路 1 號

[740/ 註冊申請人的送達地址： 中港知識產權有限公司
750] Applicant's Address for 香港
Service: 灣仔告士打道 151 號
資本中心 15 樓 1502 室

[511] 類別編號： 9, 36, 41
Class(es) No(s) .:

[511] 貨品 / 服務說明： 類別 41：
Specification: 培訓；安排和組織大會；籌劃聚會（娛樂）；健身俱樂部（健身和體能訓練）；流動圖書館；遊戲器具出租；娛樂服務；導遊服務；組織娛樂活動；組織小區教育活動；提供不可下載的在線電子出版物。

[526] 卸棄： 不適用
Disclaimer:

[529] 限制： 不適用
Limitation:

[527] 條件： 不適用
Condition:
其他： 不適用
Others

[220] 提交日期： 10-01-2022
Date of Filing:

[320] 聲稱具有優先權的日期： 不適用
Date of Priority Claimed:

[310] 優先權申請編號： 不適用
Priority Application Number:

[340] 聲稱具有優先權 (部分): 不適用
Priority Claim Details:

[330] 優先權申請的 不適用
國家、地區、地方:
Country, territory, area of
Priority Applications:

[210] 商標申請編號: 305854456
Application No.:

[540] 商標:
Mark:



[550] 商標種類: 一般商標
Mark Type:
一系列商標: 否
Series Mark:

[571] 商標描述: 不適用
Mark Description:

[730] 註冊申請人的姓名 / 名稱、地址: 中國太平洋保險 (集團) 股份有限公司
Applicant(s) ' 中國
Name, Address: 上海市黃浦區
中山南路 1 號

[740/ 註冊申請人的送達地址: 中港知識產權有限公司
750] Applicant's Address for 香港
Service: 灣仔告士打道 151 號
資本中心 15 樓 1502 室

[511] 類別編號: 9, 36, 41
Class(es) No(s).:

[511] 貨品 / 服務說明: 類別 41:
Specification: 培訓; 安排和組織大會; 籌劃聚會 (娛樂); 健身俱樂部 (健身和體能訓練); 流動圖書館; 遊戲器具出租; 娛樂服務; 導遊服務; 組織娛樂活動; 組織小區教育活動; 提供不可下載的在線電子出版物。

[526] 卸棄:	不適用
Disclaimer:	
[529] 限制:	不適用
Limitation:	
[527] 條件:	不適用
Condition:	
其他:	不適用
Others	
[220] 提交日期:	10-01-2022
Date of Filing:	
[320] 聲稱具有優先權的日期:	不適用
Date of Priority Claimed:	
[310] 優先權申請編號:	不適用
Priority Application Number:	
[340] 聲稱具有優先權 (部分):	不適用
Priority Claim Details:	
[330] 優先權申請的	不適用
國家、地區、地方:	
Country, territory, area of	
Priority Applications:	

[210] 商標申請編號: 305856067
Application No.:

[540] 商標:
Mark:



[550] 商標種類: 一般商標
Mark Type:

一系列商標: 否
Series Mark:

[571] 商標描述: 申請人聲稱藍色、綠色及白色為商標的多於一個要素。
Mark Description:

[730] 註冊申請人的姓名 / 名稱、地址: 北京華醫網科技股份有限公司
Applicant(s) ' 中國
Name, Address: 北京市海澱區

[740/ 註冊申請人的送達地址: 標準香港企業註冊服務有限公司
750] Applicant's Address for 香港
Service: 九龍旺角彌敦道 678 號
華僑商業中心 15C

[511] 類別編號: 41, 44
Class(es) No(s) .:

[511] 貨品 / 服務說明： Specification:	類別 41： 教育；培訓；教育信息；職業再培訓；實際培訓（示範）；安排和組織會議；安排和組織培訓班；出借書籍的圖書館；文字出版（廣告宣傳文本除外）；書籍出版；電子書籍和雜誌的在線出版；電子桌面排版；錄音棚服務；通過計算機網絡在線提供的遊戲服務；體操訓練；玩具出租；導遊服務；提供博物館設施（表演、展覽）；動物訓練；為藝術家提供模特服務。 類別 44： 醫藥諮詢；遠程醫學服務；健康諮詢；療養院；飲食營養指導；美容服務；動物養殖；水產養殖服務；農業、園藝及林業服務；園藝學；滅害蟲（為農業、水產養殖業、園藝或林業目的）；衛生設備出租；配鏡服務。
[526] 卸棄： Disclaimer:	不適用
[529] 限制： Limitation:	不適用
[527] 條件： Condition: 其他： Others	不適用
[220] 提交日期： Date of Filing:	12-01-2022
[320] 聲稱具有優先權的日期： Date of Priority Claimed:	不適用
[310] 優先權申請編號： Priority Application Number:	不適用
[340] 聲稱具有優先權（部分）： Priority Claim Details:	不適用
[330] 優先權申請的 國家、地區、地方： Country, territory, area of Priority Applications:	不適用

[210] 商標申請編號： 305856508
Application No.:

[540] 商標：
Mark:

A



B



[550] 商標種類： 一般商標

Mark Type:

一系列商標： 是

Series Mark:

[571] 商標描述： 不適用

Mark Description:

[730] 註冊申請人的姓名 / 名稱、地址： 李允豪

Applicant(s) ' 香港

Name, Address: 東區柴灣利眾街 12 號
蜆殼工業大廈 9 樓 C 室

[740/ 註冊申請人的送達地址： 李允豪

750] Applicant's Address for 香港

Service: 東區柴灣利眾街 12 號
蜆殼工業大廈 9 樓 C 室

[511] 類別編號： 41

Class(es) No(s) .:

[511] 貨品 / 服務說明： 類別 41:

Specification:

出版；休閒中心服務；在電腦網絡上提供在線遊戲服務；安排及舉行會議、議會、展覽、研討會、專題研討會、工作坊、演出項目、比賽及競技比賽；為藝術家提供模特服務；計劃、組織和管理議會、會議、討論會、專題研討會、研討會、講座、演講及工作坊；娛樂、運動及文化活動；健身俱樂部（健身和體能訓練）；唱片、錄音帶、磁盆、印刷品、指導及教育性材料、音樂器材、音響系統及器材、燈光系統及設備、視聽系統及設備、錄音設備及影音灌錄設備的租賃；教育及培訓服務；

教學及補習服務；設計教學課程、考試及資歷架構；就業指導（教育或培訓顧問）；提供及出租設施及設備作教育、娛樂、文化、文娛及體育之用途；提供有關教育、娛樂、文化及體育之資訊、諮詢及顧問服務；提供電子刊物、書刊、錄像、電影及演出（非下載的）；提供學校及高等教育服務；遊樂園服務；主題公園服務；電子刊物、書刊、雜誌及期刊的出版；電影、音樂、演出、藝術表演及文化活動的訂票服務；頒獎禮、戲劇、音樂會及現場表演；圖書館服務或流動圖書館服務；製作及發行（非運輸）影片、廣播及電視節目、電影、報紙、影音節目及音樂唱片；製作音樂、廣播及電視節目及演出；錄像、影片及電影之錄音及剪輯；職業輔導（教育或訓練之諮詢）；藝術展覽服務；攝影及數碼攝影；體育設備出租

- [526] 卸棄：不適用
Disclaimer:
- [529] 限制：不適用
Limitation:
- [527] 條件：不適用
Condition:
其他：不適用
Others
- [220] 提交日期：12-01-2022
Date of Filing:
- [320] 聲稱具有優先權的日期：不適用
Date of Priority Claimed:
- [310] 優先權申請編號：不適用
Priority Application Number:
- [340] 聲稱具有優先權（部分）：不適用
Priority Claim Details:
- [330] 優先權申請的國家、地區、地方：不適用
Country, territory, area of Priority Applications:

- [210] 商標申請編號：305856607
Application No.:

- [540] 商標：Mark:



- [550] 商標種類：一般商標
Mark Type:

一系列商標 :	否
Series Mark:	
[571] 商標描述 :	不適用
Mark Description:	
[730] 註冊申請人的姓名 / 名稱、地址 :	鏗鏘駕駛學校有限公司 (HUNG CHUN DRIVING SCHOOL LIMITED)
Applicant(s) 'Name, Address:	香港 九龍深水埗 長沙灣道 264 號地下 A 舖
[740/ 註冊申請人的送達地址 :	CHAN SAU KUEN
750] Applicant's Address for Service:	香港 九龍新蒲崗大有街 29 號 宏基中心 2 樓 201 室
[511] 類別編號 :	41
Class(es) No(s) .:	
[511] 貨品 / 服務說明 :	類別 41:
Specification:	教育 ; 提供培訓 ; 娛樂 ; 文體活動。
[526] 卸棄 :	不適用
Disclaimer:	
[529] 限制 :	不適用
Limitation:	
[527] 條件 :	不適用
Condition:	
其他 :	不適用
Others	
[220] 提交日期 :	12-01-2022
Date of Filing:	
[320] 聲稱具有優先權的日期 :	不適用
Date of Priority Claimed:	
[310] 優先權申請編號 :	不適用
Priority Application Number:	
[340] 聲稱具有優先權 (部分) :	不適用
Priority Claim Details:	
[330] 優先權申請的 國家、地區、地方 :	不適用
Country, territory, area of Priority Applications:	
<hr/>	
[210] 商標申請編號 :	305856706
Application No.:	

[540] 商標：
Mark:



[550] 商標種類： 一般商標
Mark Type:
一系列商標： 否
Series Mark:

[571] 商標描述： 不適用
Mark Description:

[730] 註冊申請人的姓名 / 名稱、地址： 成都龍淵網路科技有限公司
Applicant(s) ' 中國
Name, Address: 四川自由貿易試驗區
成都高新區益州大道中段 722 號 1 棟 1 單元 12 層 1205 號

[740/ 註冊申請人的送達地址：
750] Applicant's Address for 卓遠知識產權有限公司
Service: 香港
上環禧利街 27 號
富輝商業中心 10 樓

[511] 類別編號： 9, 35, 41, 42
Class(es) No(s) .:

[511] 貨品 / 服務說明： 類別 41：
Specification: 組織教育或娛樂競賽；安排和組織音樂會；電子書籍和雜誌的
在線出版；娛樂服務；演出；音樂製作；娛樂信息；在計算機
網絡上提供在線遊戲；提供在線音樂(非下載)；歌曲創作。

[526] 卸棄： 不適用
Disclaimer:

[529] 限制： 不適用
Limitation:

[527] 條件： 不適用
Condition:
其他： 不適用
Others

[220] 提交日期： 12-01-2022
Date of Filing:

[320] 聲稱具有優先權的日期： 不適用
Date of Priority Claimed:

[310] 優先權申請編號： 不適用
Priority Application Number:

[340] 聲稱具有優先權 (部分)： 不適用

Priority Claim Details:

[330] 優先權申請的 不適用
國家、地區、地方：
Country, territory, area of
Priority Applications:

[210] 商標申請編號： 305856797
Application No.:

[540] 商標：
Mark:



[550] 商標種類： Ordinary
Mark Type:
一系列商標： NO
Series Mark:

[571] 商標描述： N/A
Mark Description:

[730] 註冊申請人的姓名 / 名稱、地址： Motorverse Corporation
Applicant(s) ' Registered office Vistra Corporate Services
Name, Address: Centre
Wickhams Cay II, Road Town Tortola, VG1110
VIRGIN ISLANDS (BRITISH)

[740/ 註冊申請人的送達地址： HALDANES
750] Applicant's Address for 7/F, Ruttonjee House
Service: 11 Duddell Street, Central
HONG KONG

[511] 類別編號： 9, 25, 28, 36, 41
Class(es) No(s) .:

[511] 貨品 / 服務說明： Class 41:
Specification: Entertainment and education services in the
form of electronic, computer and video games
provided by means of the Internet, mobile
telecommunications and other remote
communication devices; Internet games (non-
downloadable); organising of games; games
(non-downloadable) played via a global
computer network; providing online interactive
and/or educational entertainment services;
education and entertainment services provided
by computer networks, television, mobile,
telephone, cable and other electronic means;

presentation, preparation, editing and production of cinematographic, televisual, digital and motion picture films, radio and television programmes; publishing of computer and videogames and computer, videogames, virtual world and blockchain software; provision of customised webpages featuring gameplay information, including information regarding players identity and preferences; publishing of entertainment and/or educational software; arranging, organising and conducting educational and/or entertainment conferences, events, competitions, raffles and seminars both in person and virtually; provision of facilities in which consumers can participate in virtual reality and augmented reality environments for recreational, leisure, entertainment or educational purposes; provision of entertainment and educational services in the nature of interactive, immersive and virtual reality events, exhibits and experiences; electronic game services provided by electronic communication means; entertainment services in the form of television, radio, cable, satellite and Internet programmes; production and presentation of television, radio, cable, satellite and Internet programmes, shows, films, videos, DVDs and other audiovisual media; games, online games; educational and services relating to entertainment.

- [526] 卸棄 : N/A
Disclaimer:
- [529] 限制 : N/A
Limitation:
- [527] 條件 : N/A
Condition:
其他 : N/A
Others
- [220] 提交日期 : 12-01-2022
Date of Filing:
- [320] 聲稱具有優先權的日期 : N/A
Date of Priority Claimed:
- [310] 優先權申請編號 : N/A
Priority Application Number:
- [340] 聲稱具有優先權 (部分) : N/A
Priority Claim Details:
- [330] 優先權申請的
國家、地區、地方 : N/A
Country, territory, area of
Priority Applications:

[210] 商標申請編號 : 305856805
Application No.:

[540] 商標 :
Mark: **TORQUE SQUAD**

[550] 商標種類 : Ordinary
Mark Type:
一系列商標 : NO
Series Mark:

[571] 商標描述 : N/A
Mark Description:

[730] 註冊申請人的姓名 / 名稱、地址 : Motorverse Corporation
Applicant(s) ' Registered office Vistra Corporate Services
Name,Address: Centre
Wickhams Cay II, Road Town Tortola, VG1110
VIRGIN ISLANDS (BRITISH)

[740/ 註冊申請人的送達地址 : HALDANES
750] Applicant's Address for 7/F, Ruttonjee House
Service: 11 Duddell Street, Central
HONG KONG

[511] 類別編號 : 9,25,28,36,41
Class(es) No(s) .:

[511] 貨品 / 服務說明 : Class 41:
Specification: Entertainment and education services in the form of electronic, computer and video games provided by means of the Internet, mobile telecommunications and other remote communication devices; Internet games (non-downloadable); organising of games; games (non-downloadable) played via a global computer network; providing online interactive and/or educational entertainment services; education and entertainment services provided by computer networks, television, mobile, telephone, cable and other electronic means; presentation, preparation, editing and production of cinematographic, televisual, digital and motion picture films, radio and television programmes; publishing of computer and videogames and computer, videogames, virtual world and blockchain software; provision of customised webpages featuring gameplay information, including information regarding players identity and preferences; publishing of entertainment and/or educational software; arranging, organising and conducting educational and/or entertainment conferences, events, competitions, raffles and seminars both in person and virtually; provision of facilities in which consumers can participate in virtual reality and augmented reality

environments for recreational, leisure, entertainment or educational purposes; provision of entertainment and educational services in the nature of interactive, immersive and virtual reality events, exhibits and experiences; electronic game services provided by electronic communication means; entertainment services in the form of television, radio, cable, satellite and Internet programmes; production and presentation of television, radio, cable, satellite and Internet programmes, shows, films, videos, DVDs and other audiovisual media; games, online games; educational and services relating to entertainment.

- [526] 卸棄 : N/A
Disclaimer:
- [529] 限制 : N/A
Limitation:
- [527] 條件 : N/A
Condition:
其他 : N/A
Others
- [220] 提交日期 : 12-01-2022
Date of Filing:
- [320] 聲稱具有優先權的日期 : N/A
Date of Priority Claimed:
- [310] 優先權申請編號 : N/A
Priority Application Number:
- [340] 聲稱具有優先權 (部分) : N/A
Priority Claim Details:
- [330] 優先權申請的 : N/A
國家、地區、地方 :
Country, territory, area of
Priority Applications:
-
-

- [210] 商標申請編號 : 305856814
Application No.:

[540] 商標 :
Mark:

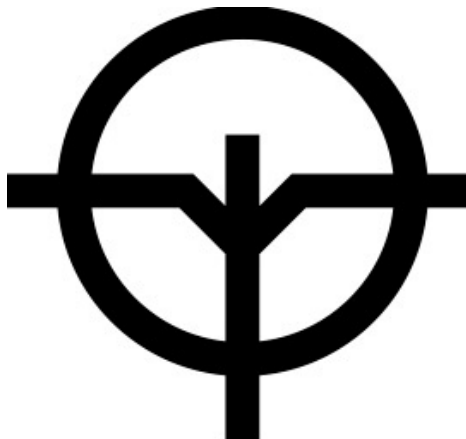

[550] 商標種類 : Ordinary
Mark Type:
一系列商標 : NO
Series Mark:

[571] 商標描述 : N/A
Mark Description:

[730] 註冊申請人的姓名 / 名稱、地址 : Motorverse Corporation
Applicant(s) ' Registered office Vistra Corporate Services
Name,Address: Centre
Wickhams Cay II, Road Town Tortola, VG1110
VIRGIN ISLANDS (BRITISH)

[740/ 註冊申請人的送達地址 : HALDANES
750] Applicant's Address for 7/F, Ruttonjee House
Service: 11 Duddell Street, Central
HONG KONG

[511] 類別編號 : 9,25,28,36,41
Class(es) No(s) .:

[511] 貨品 / 服務說明 : Class 41:
Specification: Entertainment and education services in the form of electronic, computer and video games provided by means of the Internet, mobile telecommunications and other remote communication devices; Internet games (non-downloadable); organising of games; games (non-downloadable) played via a global computer network; providing online interactive and/or educational entertainment services; education and entertainment services provided by computer networks, television, mobile, telephone, cable and other electronic means; presentation, preparation, editing and production of cinematographic, televisual, digital and motion picture films, radio and television programmes; publishing of computer and videogames and computer, videogames, virtual world and blockchain software; provision of customised webpages featuring gameplay information, including information regarding players identity and preferences; publishing of entertainment and/or educational

software; arranging, organising and conducting educational and/or entertainment conferences, events, competitions, raffles and seminars both in person and virtually; provision of facilities in which consumers can participate in virtual reality and augmented reality environments for recreational, leisure, entertainment or educational purposes; provision of entertainment and educational services in the nature of interactive, immersive and virtual reality events, exhibits and experiences; electronic game services provided by electronic communication means; entertainment services in the form of television, radio, cable, satellite and Internet programmes; production and presentation of television, radio, cable, satellite and Internet programmes, shows, films, videos, DVDs and other audiovisual media; games, online games; educational and services relating to entertainment.

- [526] 卸棄 : N/A
Disclaimer:
- [529] 限制 : N/A
Limitation:
- [527] 條件 : N/A
Condition:
其他 : N/A
Others
- [220] 提交日期 : 12-01-2022
Date of Filing:
- [320] 聲稱具有優先權的日期 : N/A
Date of Priority Claimed:
- [310] 優先權申請編號 : N/A
Priority Application Number:
- [340] 聲稱具有優先權 (部分) : N/A
Priority Claim Details:
- [330] 優先權申請的 : N/A
國家、地區、地方 :
Country, territory, area of
Priority Applications:

[210] 商標申請編號 : 305856823
Application No.:

[540] 商標 :
Mark:

MOTORVERSE

[550] 商標種類 : Ordinary
Mark Type:
一系列商標 : NO
Series Mark:

[571] 商標描述 : N/A
Mark Description:

[730] 註冊申請人的姓名 / 名稱、地址 : Motorverse Corporation
Applicant(s) ' Registered office Vistra Corporate Services
Name,Address: Centre
Wickhams Cay II, Road Town Tortola, VG1110
VIRGIN ISLANDS (BRITISH)

[740/ 註冊申請人的送達地址 : HALDANES
750] Applicant's Address for 7/F, Ruttonjee House
Service: 11 Duddell Street, Central
HONG KONG

[511] 類別編號 : 9,25,28,36,41
Class(es) No(s) .:

[511] 貨品 / 服務說明 : Class 41:
Specification: Entertainment and education services in the form of electronic, computer and video games provided by means of the Internet, mobile telecommunications and other remote communication devices; Internet games (non-downloadable); organising of games; games (non-downloadable) played via a global computer network; providing online interactive and/or educational entertainment services; education and entertainment services provided by computer networks, television, mobile, telephone, cable and other electronic means; presentation, preparation, editing and production of cinematographic, televisual, digital and motion picture films, radio and television programmes; publishing of computer and videogames and computer, videogames, virtual world and blockchain software; provision of customised webpages featuring gameplay information, including information regarding players identity and preferences; publishing of entertainment and/or educational software; arranging, organising and conducting educational and/or entertainment conferences, events, competitions, raffles and seminars both in person and virtually; provision of facilities in which consumers can participate in virtual reality and augmented reality environments for recreational, leisure, entertainment or educational purposes; provision of entertainment and educational services in the nature of interactive, immersive and virtual reality events, exhibits and experiences; electronic game services provided by electronic communication means; entertainment services in the form of television, radio, cable, satellite and

Internet programmes; production and presentation of television, radio, cable, satellite and Internet programmes, shows, films, videos, DVDs and other audiovisual media; games, online games; educational and services relating to entertainment.

- [526] 卸棄 : N/A
Disclaimer:
- [529] 限制 : N/A
Limitation:
- [527] 條件 : N/A
Condition:
其他 : N/A
Others
- [220] 提交日期 : 12-01-2022
Date of Filing:
- [320] 聲稱具有優先權的日期 : N/A
Date of Priority Claimed:
- [310] 優先權申請編號 : N/A
Priority Application Number:
- [340] 聲稱具有優先權 (部分) : N/A
Priority Claim Details:
- [330] 優先權申請的
國家、地區、地方 : N/A
Country, territory, area of
Priority Applications:

- [210] 商標申請編號 : 305856913
Application No.:
- [540] 商標 : A
Mark:



B



- [550] 商標種類 : Ordinary
 Mark Type:
 一系列商標 : YES
 Series Mark:
- [571] 商標描述 : N/A
 Mark Description:
- [730] 註冊申請人的姓名 / 名稱、地址 : Lemon Inc.
 Applicant(s) ' P.O. Box 31119 Grand Pavilion, Hibiscus Way,
 Name,Address: 802 West Bay Road, Grand Cayman, KY1 - 1205,
 CAYMAN ISLANDS
- [740/ 註冊申請人的送達地址 : Rouse & Co. International (Overseas) Limited
 750] Applicant's Address for 26/F., Tesbury Centre,
 Service: 28 Queen's Road East
 HONG KONG
- [511] 類別編號 : 9, 35, 38, 41, 42, 45
 Class(es) No(s) .:
- [511] 貨品 / 服務說明 : Class 41:
 Specification: Educational services; training services;
 presentation of music; provision of online
 electronic publications (not downloadable),
 via mobile devices; multimedia publishing of
 printed matter, books, magazines, journals,
 newspapers, newsletters, tutorials, maps,
 graphics, photographs, videos, music and
 electronic publications; electronic
 publication of information on a wide range of
 topics on-line; entertainment and amusement
 information via the internet; entertainment
 services; organization and presentation of
 shows, competitions, games, concerts and
 entertainment events; arranging, organizing,
 conducting, and hosting social entertainment
 events; music publication services; music
 production services; music recording services;
 music library services; providing non-
 downloadable digital music from a global
 computer network; providing music [not
 downloadable] through the Internet; providing
 online music, non-downloadable; providing

online non-downloadable audio and video recordings featuring music; provision of information relating to music; presentation of live performances; presentation of music videos via mobile device online.

- [526] 卸棄 : N/A
Disclaimer:
- [529] 限制 : N/A
Limitation:
- [527] 條件 : N/A
Condition:
其他 : N/A
Others
- [220] 提交日期 : 12-01-2022
Date of Filing:
- [320] 聲稱具有優先權的日期 : N/A
Date of Priority Claimed:
- [310] 優先權申請編號 : N/A
Priority Application Number:
- [340] 聲稱具有優先權 (部分) : N/A
Priority Claim Details:
- [330] 優先權申請的
國家、地區、地方 : N/A
Country, territory, area of
Priority Applications:

- [210] 商標申請編號 : 305857651
Application No.:
- [540] 商標 :
Mark:



THE BEST OF THE BEST

美食之最大賞

ASIA ART OF CUISINE ASSOCIATION OF HONG KONG

- [550] 商標種類 : 一般商標
Mark Type:
- 一系列商標 : 否
Series Mark:

- [571] 商標描述 : 不適用
Mark Description:
- [730] 註冊申請人的姓名 / 名稱、地址 : 亞洲餐飲廚藝協會有限公司
Applicant(s) ' 香港
Name,Address: 新界葵涌大連排道 83 號
K83 12 樓 3 室
- [740/ 註冊申請人的送達地址 : 卓遠知識產權有限公司
750] Applicant's Address for 香港
Service: 上環禧利街 27 號
富輝商業中心 10 樓
- [511] 類別編號 : 41
Class(es) No(s) .:
- [511] 貨品 / 服務說明 : 類別 41:
Specification: 舉辦頒獎活動; 組織競賽
- [526] 卸棄 : 不適用
Disclaimer:
- [529] 限制 : 不適用
Limitation:
- [527] 條件 : 不適用
Condition:
其他 : 不適用
Others
- [220] 提交日期 : 13-01-2022
Date of Filing:
- [320] 聲稱具有優先權的日期 : 不適用
Date of Priority Claimed:
- [310] 優先權申請編號 : 不適用
Priority Application Number:
- [340] 聲稱具有優先權 (部分) : 不適用
Priority Claim Details:
- [330] 優先權申請的 不適用
國家、地區、地方 :
Country, territory, area of
Priority Applications:
-
-

- [210] 商標申請編號 : 305857723
Application No.:

[540] 商標 :
Mark:



[550] 商標種類 : Ordinary
Mark Type:
一系列商標 : NO
Series Mark:

[571] 商標描述 : N/A
Mark Description:

[730] 註冊申請人的姓名 / 名稱、地址 : MOOOFIT LIMITED
Applicant(s) ' 3/F, MIDAS PLAZA
Name,Address: No. 1 TAI YAU STREET, SAN PO KONG, KOWLOON
HONG KONG

[740/ 註冊申請人的送達地址 : GLOBAL INTELLECTUAL PROPERTY COMPANY LIMITED
750] Applicant's Address for Unit 602-3 & 5, 6/F, Exchange Tower
Service: 33 Wang Chiu Road, Kowloon Bay, Kowloon
HONG KONG

[511] 類別編號 : 41
Class(es) No(s) .:

[511] 貨品 / 服務說明 : Class 41:
Specification: Education and training services; organizing, planning, arranging, managing and conducting congresses, conferences, conventions, exhibitions, symposiums or colloquiums, talks, forums, sharing sessions, workshops and seminars; organizing, planning, arranging and conducting lectures, talks, workshops, seminars including those featuring information of personal life management, personal life and career planning, promotion and sales skills, marketing skills, interpersonal relationship, leaderships and leadership skills, and for improving interpersonal relationship and leaderships and increasing personal productivity and competitiveness, as well as achieving success in life; design and provision of educational programmes, tutorials and courses; design, arranging, conducting and providing of training programmes and courses; training services, namely, arranging and conducting training programmes and courses including those for corporates to improve employee morale and productivity; provision of educational and training video programmes

online featuring information of personal life management, personal life and career planning, promotion and sales skills, marketing skills, interpersonal relationship, leaderships and leadership skills, and for improving interpersonal relationship and leaderships and increasing personal productivity and competitiveness, as well as achieving success in life; organizing, planning, arranging and conducting event and activities for training purposes; production and publication of books, text books, magazines, leaflets, booklets, manuals, handbooks, newsletters and periodical, texts (other than publicity text); production and online publication of audio, video and video programmes for educational and training purposes; production and publication of video and video programmes featuring information of personal life management, personal life and career planning, promotion and sales skills, marketing skills, interpersonal relationship, leaderships and leadership skills, and for improving interpersonal relationship and leaderships and increasing personal productivity and competitiveness, as well as achieving success in life; career counselling [training and education advice]; provision of information related to all the aforesaid services via the Internet, online website and social media websites; all the aforesaid services included in Class 41

- [526] 卸棄 : N/A
Disclaimer:
- [529] 限制 : N/A
Limitation:
- [527] 條件 : N/A
Condition:
其他 : N/A
Others
- [220] 提交日期 : 13-01-2022
Date of Filing:
- [320] 聲稱具有優先權的日期 : N/A
Date of Priority Claimed:
- [310] 優先權申請編號 : N/A
Priority Application Number:
- [340] 聲稱具有優先權 (部分) : N/A
Priority Claim Details:
- [330] 優先權申請的
國家、地區、地方 : N/A
Country, territory, area of
Priority Applications:

[210] 商標申請編號 : 305857804

Application No.:

[540] 商標 :

Mark:



[550] 商標種類 : 一般商標

Mark Type:

一系列商標 :

否

Series Mark:

[571] 商標描述 : 不適用

Mark Description:

[730] 註冊申請人的姓名 / 名稱、地址 : 香港花式跳繩會有限公司

Applicant(s) '

Name, Address:

香港

九龍灣宏照道 25 號

源發工業大廈 3 樓 5 室

[740/ 註冊申請人的送達地址 :

750] Applicant's Address for

Service:

陳振光

香港

九龍灣宏照道 25 號

源發工業大廈 3 樓 5 室

[511] 類別編號 : 25, 28, 41

Class(es) No(s) .:

[511] 貨品 / 服務說明 : 類別 41:

Specification:

提供跳繩培訓

[526] 卸棄 : 不適用

Disclaimer:

[529] 限制 : 不適用

Limitation:

[527] 條件 : 不適用

Condition:

其他 :

不適用

Others

[220] 提交日期 : 13-01-2022

Date of Filing:

[320] 聲稱具有優先權的日期 : 不適用

Date of Priority Claimed:

[310] 優先權申請編號 : 不適用

Priority Application Number:

[340]	聲稱具有優先權 (部分): Priority Claim Details:	不適用
[330]	優先權申請的 國家、地區、地方: Country, territory, area of Priority Applications:	不適用
[210]	商標申請編號: Application No.:	305859433
[540]	商標: Mark:	音韻樂心靈 Melody in Mind
[550]	商標種類: Mark Type:	Ordinary
	一系列商標: Series Mark:	NO
[571]	商標描述: Mark Description:	N/A
[730]	註冊申請人的姓名 / 名稱、地址: Applicant(s)' Name, Address:	Hong Kong Breast Cancer Foundation Limited 22/F, Jupiter Tower 9 Jupiter Street, North Point HONG KONG
[740/ 750]	註冊申請人的送達地址: Applicant's Address for Service:	Pansy Leung Tang & Chua Solicitors 21/F, Regent Centre, No.88 Queen's Road Central HONG KONG
[511]	類別編號: Class(es) No(s) .:	16, 36, 41, 42, 44, 45
[511]	貨品 / 服務說明: Specification:	Class 41: Arranging, conducting, production and presentation of live performance; performance of music; education; providing of training; entertainment; sporting and cultural activities.
[526]	卸棄: Disclaimer:	N/A
[529]	限制: Limitation:	N/A
[527]	條件: Condition:	N/A
	其他: Others	N/A
[220]	提交日期: Date of Filing:	17-01-2022
[320]	聲稱具有優先權的日期: Date of Priority Claimed:	N/A

- [310] 優先權申請編號 : N/A
Priority Application Number:
- [340] 聲稱具有優先權 (部分) : N/A
Priority Claim Details:
- [330] 優先權申請的
國家、地區、地方 : N/A
Country, territory, area of
Priority Applications:

- [210] 商標申請編號 : 305861151
Application No.:

- [540] 商標 :
Mark:



- [550] 商標種類 : 一般商標
Mark Type:
- 一系列商標 : 否
Series Mark:
- [571] 商標描述 : 申請人聲稱紅色及白色為商標的要素。
Mark Description:
- [730] 註冊申請人的姓名 / 名稱、地址 : 學嘢吧兄弟有限公司 (HotYeah Brother Limited)
Applicant(s) ' Name, Address: 香港
九龍尖沙咀廣東道 28 號
力寶太陽廣場 1216 室
- [740/ 註冊申請人的送達地址 : U&I Group Limited
750] Applicant's Address for 香港
Service: 九龍尖沙咀東科學館道 14 號
新文華中心 A 座 10 樓 1015 室
- [511] 類別編號 : 41
Class(es) No(s) .:
- [511] 貨品 / 服務說明 : 類別 41:
Specification: 出版; 休閒中心服務; 在電腦網絡上提供在線遊戲服務; 安排及舉行會議、議會、展覽、研討會、專題研討會、工作坊、演出項目、比賽及競技比賽; 為藝術家提供模特服務; 計劃、組織和管理議會、會議、討論會、專題研討會、研討會、講座、演講及工作坊; 娛樂、運動及文化活動; 健身俱樂部 (健身和體能訓練); 唱片、錄音帶、磁盤、印刷品、指導及教育性材

料、音樂器材、音響系統及器材、燈光系統及設備、視聽系統及設備、錄音設備及影音灌錄設備的租賃；教育及培訓服務；教學及補習服務；設計教學課程、考試及資歷架構；就業指導（教育或培訓顧問）；提供及出租設施及設備作教育、娛樂、文化、文娛及體育之用途；提供有關教育、娛樂、文化及體育之資訊、諮詢及顧問服務；提供電子刊物、書刊、錄像、電影及演出（非下載的）；提供學校及高等教育服務；遊樂園服務；主題公園服務；電子刊物、書刊、雜誌及期刊的出版；電影、音樂、演出、藝術表演及文化活動的訂票服務；頒獎禮、戲劇、音樂會及現場表演；圖書館服務或流動圖書館服務；製作及發行（非運輸）影片、廣播及電視節目、電影、報紙、影音節目及音樂唱片；製作音樂、廣播及電視節目及演出；錄像、影片及電影之錄音及剪輯；職業輔導（教育或訓練之諮詢）；藝術展覽服務；攝影及數碼攝影；體育設備出租

[526]	卸棄： Disclaimer:	不適用
[529]	限制： Limitation:	不適用
[527]	條件： Condition:	不適用
	其他： Others	不適用
[220]	提交日期： Date of Filing:	18-01-2022
[320]	聲稱具有優先權的日期： Date of Priority Claimed:	不適用
[310]	優先權申請編號： Priority Application Number:	不適用
[340]	聲稱具有優先權（部分）： Priority Claim Details:	不適用
[330]	優先權申請的 國家、地區、地方： Country, territory, area of Priority Applications:	不適用

[210]	商標申請編號： Application No.:	305861214
-------	-----------------------------	-----------

[540] 商標 :
Mark:



[550] 商標種類 : 一般商標
Mark Type:
一系列商標 : 否
Series Mark:

[571] 商標描述 : 不適用
Mark Description:

[730] 註冊申請人的姓名 / 名稱、地址 : Hong Kong Intellectual Property Exchange, Ltd.
Applicant(s) ' Level 17, Silvercord Tower 2,
Name, Address: 30 Canton Road, Tsim Sha Tsui, Kowloon
HONG KONG

[740/ 註冊申請人的送達地址 : HKIPX
750] Applicant's Address for Level 17, Silvercord Tower 2,
Service: 30 Canton Road, Tsim Sha Tsui, Kowloon,
HONG KONG

[511] 類別編號 : 41, 45
Class(es) No(s) .:

[511] 貨品 / 服務說明 : 類別 41:
Specification: 在線電子書籍和雜誌的出版; 書籍和書評出版; 教育; 培訓;
教育考核; 就業指導 (教育或培訓顧問); 安排和組織大會; 文字出版 (廣告宣傳文本除外); 組織文化藝術活動; 職業再培訓;
組織文化或教育展覽; 雜誌的出版; 商業培訓諮詢服務; 安排在教育機構中進行的培訓課程
類別 45:
知識產權諮詢; 知識產權許可; 專利許可諮詢; 版權許可諮詢;
版權管理諮詢; 知識產權代理服務; 商標代理服務; 有關知識產權的顧問服務; 專利許可申請 (法律服務); 已註冊的外觀設計的許可 (法律服務); 為法律諮詢目的監控知識產權; 有關經營的專業法律諮詢; 版權管理; 訴訟服務

[526] 卸棄 : 不適用
Disclaimer:

[529] 限制 : 不適用
Limitation:

[527] 條件 : 不適用
Condition:
其他 : 不適用
Others

[220] 提交日期 : 18-01-2022
Date of Filing:
[320] 聲稱具有優先權的日期 : 不適用
Date of Priority Claimed:
[310] 優先權申請編號 : 不適用
Priority Application Number:
[340] 聲稱具有優先權 (部分) : 不適用
Priority Claim Details:
[330] 優先權申請的 不適用
國家、地區、地方 :
Country, territory, area of
Priority Applications:

[210] 商標申請編號 : 305861647
Application No.:

[540] 商標 :
Mark:

A



B



C



D

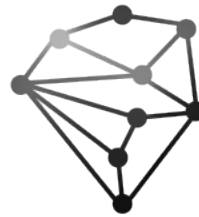

AYDA AWARDS

Since 2008

- [550] 商標種類 : Ordinary
 Mark Type:
 一系列商標 : YES
 Series Mark:
- [571] 商標描述 : N/A
 Mark Description:
- [730] 註冊申請人的姓名 / 名稱、地址 : NIPPON PAINT HOLDINGS SG PTE. LTD.
 Applicant(s) ' 24 RAFFLES PLACE #20-03 CLIFFORD CENTRE
 Name,Address: SINGAPORE 048621
 SINGAPORE
- [740/ 註冊申請人的送達地址 : WOO KWAN LEE & LO
 750] Applicant's Address for Room 2801, Sun Hung Kai Centre,
 Service: 30 Harbour Road, Wanchai
 HONG KONG
- [511] 類別編號 : 41
 Class(es) No(s) .:
- [511] 貨品 / 服務說明 : Class 41:
 Specification: Arranging and conducting of competitions [education or entertainment]; Arranging of competitions; Arranging of competitions via the Internet; Conducting of competitions on the Internet; Organisation of competitions [education or entertainment]; Arranging of award ceremonies; Arranging and conducting educational conferences; Arranging and conducting of conferences, congresses and symposiums; Arranging, conducting and organization of conferences; Organisation of congresses and conferences for cultural and educational purposes; Organization of conferences; Arranging of exhibitions for educational purposes; Conducting of exhibitions for educational purposes; Organisation of exhibitions for cultural or educational purposes; Electronic publication of information on a wide range of topics, including online and over a global computer network; Multimedia publishing of printed matter; Publication and editing of printed

matter; Online electronic publishing of books and periodicals; Arranging and conducting of conventions; Arranging and conducting of workshops and seminars; Arranging, conducting and organisation of seminars; Conducting of instructional seminars; Educational seminars; Education and training services; Providing information in the field of education; Charitable services, namely education and training; Arranging of contests; Organisation of contests [education or entertainment]; Event management services [organisation of educational, entertainment, sporting or cultural events].

- [526] 卸棄 : N/A
Disclaimer:
- [529] 限制 : N/A
Limitation:
- [527] 條件 : N/A
Condition:
其他 : N/A
Others
- [220] 提交日期 : 18-01-2022
Date of Filing:
- [320] 聲稱具有優先權的日期 : N/A
Date of Priority Claimed:
- [310] 優先權申請編號 : N/A
Priority Application Number:
- [340] 聲稱具有優先權 (部分) : N/A
Priority Claim Details:
- [330] 優先權申請的
國家、地區、地方 : N/A
Country, territory, area of
Priority Applications:

- [210] 商標申請編號 : 305862628
Application No.:
- [540] 商標 : A
Mark:



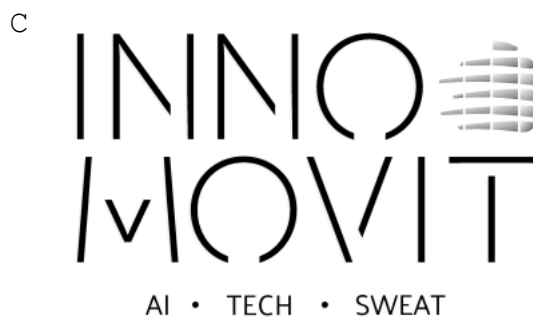

[550] 商標種類 :	Ordinary
Mark Type:	
一 系列商標 :	YES
Series Mark:	
[571] 商標描述 :	N/A
Mark Description:	
[730] 註冊申請人的姓名 / 名稱、地址 :	Movit Technology (Hong Kong) Limited (動動網絡
Applicant(s) ' Name, Address:	科技(香港)有限公司) 16/F., Far East Consortium Building, 121 Des Voeux Road Central, Central, HONG KONG
[740/ 註冊申請人的送達地址 :	ACCOLADE IP LIMITED
750] Applicant's Address for Service:	10/F, Fu Fai Comm. Ctr., 27 Hillier Street, Sheung Wan, HONG KONG
[511] 類別編號 :	9, 41
Class(es) No(s) .:	
[511] 貨品 / 服務說明 :	Class 41:
Specification:	Education and training services; sports training; physical education; teaching services; teaching of yoga exercises; exercise instruction; teaching relating to physical fitness; fitness training services; physical fitness club services; health club services [health, exercise and fitness training]; personal trainer services [fitness training]; conducting classes and courses in relation to physical fitness; organization of sports competitions; movie studio services; recording studio services; production of radio and television programmes; providing sports facilities; publishing of books and magazines relating to physical fitness and fitness training; publication of electronic

publications, books, magazines and journals relating to physical fitness and fitness training; publication of on-line electronic text (other than publicity text); provision of information of all the aforesaid via online website, social media websites; all the aforesaid included in class 41.

[526] 卸棄: N/A
Disclaimer:

[529] 限制: N/A
Limitation:

[527] 條件: N/A
Condition:
其他: N/A
Others

[220] 提交日期: 19-01-2022
Date of Filing:

[320] 聲稱具有優先權的日期: N/A
Date of Priority Claimed:

[310] 優先權申請編號: N/A
Priority Application Number:

[340] 聲稱具有優先權 (部分): N/A
Priority Claim Details:

[330] 優先權申請的
國家、地區、地方: N/A
Country, territory, area of
Priority Applications:

[210] 商標申請編號: 305863177
Application No.:

[540] 商標:
Mark:

age of doom

[550] 商標種類: Ordinary
Mark Type:
一系列商標: NO
Series Mark:

[571] 商標描述: N/A
Mark Description:

[730] 註冊申請人的姓名 / 名稱、地址: Hong Kong Ke Mo software Co., Limited
Applicant(s) ' 9/F., MW Tower,
Name,Address: No.111 Bonham Strand, Sheung Wan,
HONG KONG

[740/ 註冊申請人的送達地址: HONG KONG VICTORY INTELLECTUAL PROPERTY AGENT
750] Applicant's Address for CO., LIMITED
Service: RM 703,7/F PROSPER COMM BLDG,

9 YIN CHONG ST, MONGKOK, KLN,
HONG KONG

- [511] 類別編號 : 9,41,42
Class(es) No(s) .:
- [511] 貨品 / 服務說明 :
Specification:
Class 41:
Organization of competitions [education or entertainment]; Layout services, other than for advertising purposes; Providing online electronic publications, not downloadable; Games equipment rental; Providing online music, not downloadable; Videotaping; Translation; Online game services provided via a computer network; Scriptwriting, other than for advertising purposes; Film production, other than advertising films; Virtual reality game services provided on-line from a computer network; Electronic games services provided by means of the internet; Game services provided online from a computer network; Organization of electronic game competitions; Game services for mobile phones; Online game services through mobile devices.
- [526] 卸棄 : N/A
Disclaimer:
- [529] 限制 : N/A
Limitation:
- [527] 條件 : N/A
Condition:
其他 : N/A
Others
- [220] 提交日期 : 19-01-2022
Date of Filing:
- [320] 聲稱具有優先權的日期 : N/A
Date of Priority Claimed:
- [310] 優先權申請編號 : N/A
Priority Application Number:
- [340] 聲稱具有優先權 (部分) : N/A
Priority Claim Details:
- [330] 優先權申請的
國家、地區、地方 : N/A
Country, territory, area of
Priority Applications:
-
-

- [210] 商標申請編號 : 305863186
Application No.:

[540] 商標 :
Mark:

Age of Evil

[550] 商標種類 : Ordinary
Mark Type:
一系列商標 : NO
Series Mark:

[571] 商標描述 : N/A
Mark Description:

[730] 註冊申請人的姓名 / 名稱、地址 : Hong Kong Ke Mo software Co., Limited
Applicant(s) ' 9/F., MW Tower,
Name,Address: No.111 Bonham Strand, Sheung Wan,
HONG KONG

[740/ 註冊申請人的送達地址 : HONG KONG VICTORY INTELLECTUAL PROPERTY AGENT
750] Applicant's Address for CO., LIMITED
Service: RM 703,7/F PROSPER COMM BLDG,
9 YIN CHONG ST, MONGKOK, KLN,
HONG KONG

[511] 類別編號 : 9,41,42
Class(es) No(s) .:

[511] 貨品 / 服務說明 : Class 41:
Specification: Organization of competitions [education or
entertainment]; Layout services, other than
for advertising purposes; Providing online
electronic publications, not downloadable;
Games equipment rental; Providing online
music, not downloadable; Videotaping;
Translation; Online game services provided via
a computer network; Scriptwriting, other than
for advertising purposes; Film production,
other than advertising films; Virtual reality
game services provided on-line from a computer
network; Electronic games services provided by
means of the internet; Game services provided
online from a computer network; Organization
of electronic game competitions; Game services
for mobile phones; Online game services
through mobile devices.

[526] 卸棄 : N/A
Disclaimer:

[529] 限制 : N/A
Limitation:

[527] 條件 : N/A
Condition:
其他 : N/A
Others

[220] 提交日期 : 19-01-2022
Date of Filing:

[320] 聲稱具有優先權的日期 : N/A
Date of Priority Claimed:

[310] 優先權申請編號 : N/A

Priority Application Number:

- [340] 聲稱具有優先權 (部分): N/A
Priority Claim Details:
- [330] 優先權申請的 N/A
國家、地區、地方:
Country, territory, area of
Priority Applications:

-
- [210] 商標申請編號: 305863195
Application No.:
- [540] 商標:
Mark:

Age of Apocalypse

- [550] 商標種類: Ordinary
Mark Type:
一系列商標: NO
Series Mark:
- [571] 商標描述: N/A
Mark Description:
- [730] 註冊申請人的姓名 / 名稱、地址: Hong Kong Ke Mo software Co., Limited
Applicant(s) ' 9/F., MW Tower,
Name, Address: No.111 Bonham Strand, Sheung Wan,
HONG KONG
- [740/ 註冊申請人的送達地址: HONG KONG VICTORY INTELLECTUAL PROPERTY AGENT
750] Applicant's Address for CO., LIMITED
Service: RM 703, 7/F PROSPER COMM BLDG,
9 YIN CHONG ST, MONGKOK, KLN,
HONG KONG
- [511] 類別編號: 9, 41, 42
Class(es) No(s) .:
- [511] 貨品 / 服務說明: Class 41:
Specification: Organization of competitions [education or
entertainment]; Layout services, other than
for advertising purposes; Providing online
electronic publications, not downloadable;
Games equipment rental; Providing online
music, not downloadable; Videotaping;
Translation; Online game services provided via
a computer network; Scriptwriting, other than
for advertising purposes; Film production,
other than advertising films; Virtual reality
game services provided on-line from a computer
network; Electronic games services provided by
means of the internet; Game services provided
online from a computer network; Organization
of electronic game competitions; Game services

for mobile phones; Online game services through mobile devices.

- [526] 卸棄: N/A
Disclaimer:
- [529] 限制: N/A
Limitation:
- [527] 條件: N/A
Condition:
其他: N/A
Others
- [220] 提交日期: 19-01-2022
Date of Filing:
- [320] 聲稱具有優先權的日期: N/A
Date of Priority Claimed:
- [310] 優先權申請編號: N/A
Priority Application Number:
- [340] 聲稱具有優先權 (部分): N/A
Priority Claim Details:
- [330] 優先權申請的
國家、地區、地方: N/A
Country, territory, area of
Priority Applications:

-
- [210] 商標申請編號: 305863663
Application No.:
- [540] 商標:
Mark:



- [550] 商標種類: Ordinary
Mark Type:
一系列商標: NO
Series Mark:
- [571] 商標描述: N/A
Mark Description:
- [730] 註冊申請人的姓名 / 名稱、地址: ASSOCIATION 42
Applicant(s) ' 96, Boulevard Bessières
Name, Address:

75017 Paris
FRANCE

- [740/ 註冊申請人的送達地址 :
750] Applicant's Address for Service: GLOBAL ZEN IP SERVICES LIMITED
Room 1707, 17th Floor Beverly House,
93-107 Lockhart Road, Wanchai,
HONG KONG
- [511] 類別編號 : 41
Class(es) No(s) .:
- [511] 貨品 / 服務說明 :
Specification: Class 41:
Providing of training; teaching; education;
education and training services, notably in
the in the field of computer hardware and
computer code; interactive training and
provision of training information on any
computer network, open or closed, including
the Internet; schools, educational institutes
and training schools; organisation and
conducting of educational examinations and of
workshops [training]; entertainment services;
organization of competitions [education or
entertainment]; arranging and conducting of
colloquiums, conferences, educational and
entertainment events, workshops [training] or
congresses [training]; organization of
exhibitions for cultural or educational
purposes; booking of seats for shows.
- [526] 卸棄 :
Disclaimer: N/A
- [529] 限制 :
Limitation: N/A
- [527] 條件 :
Condition: N/A
- 其他 :
Others N/A
- [220] 提交日期 : 20-01-2022
Date of Filing:
- [320] 聲稱具有優先權的日期 : N/A
Date of Priority Claimed:
- [310] 優先權申請編號 : N/A
Priority Application Number:
- [340] 聲稱具有優先權 (部分) : N/A
Priority Claim Details:
- [330] 優先權申請的
國家、地區、地方 : N/A
Country, territory, area of
Priority Applications:
-
- [210] 商標申請編號 : 305864095
Application No.:

[540] 商標 :
Mark:

Formula Edge

[550] 商標種類 : Ordinary

Mark Type:

一系列商標 : NO

Series Mark:

[571] 商標描述 : N/A

Mark Description:

[730] 註冊申請人的姓名 / 名稱、地址 :

STEM Plus Limited

Applicant(s) ' Name, Address:

Hung Hing Printing Centre, 17-19 Dai Hei Street,

Tai Po Industrial Estate, New Territories, HONG KONG

[740/ 註冊申請人的送達地址 :

ELLALAN

750] Applicant's Address for Service:

26th - 28th Floors, The Hennessy,

256 Hennessy Road, Wanchai,

Hong Kong

[511] 類別編號 :

41

Class(es) No(s) .:

[511] 貨品 / 服務說明 :

Class 41:

Specification:

Education; providing of training; entertainment; sporting and cultural activities; publication of texts, books and journals (others than publicity texts); publication of diagrams, images and photographs; publication of newspapers, magazines and periodicals; provision of education, recreation, instruction, tuition and training both interactive and non-interactive; design of educational courses, examinations and qualifications; provision of information relating to education, training, entertainment, recreation, sporting, social and cultural activities; providing not downloadable on-line electronic publications; educational and training services relating to innovation, science, technology, engineering and mathematics; educational and training services relating to computer programming, cloud computing, artificial intelligence and edge processing; educational and training services in the field of automotive technology, namely, arranging, organising and conducting activities, events, exhibitions, trainings, workshops, mentoring, tutoring, classes, programs, seminars and conferences relating to radio-controlled vehicles, model cars having a motor and driven by remote control, automotive engineering, fully or partially autonomously operated motorized vehicles, automobiles, driver assistance and self-driving systems; provision of education

or training in the field of research, development and design of software, artificial intelligence, image processing devices, navigation, targeting, mapping and guidance devices for fully or partially autonomously operated motorized vehicles; provision of education or training in the field of automotive technology related to vehicle safety, passenger safety, driver assistance and self-driving systems; arranging, organising and conducting entertainment services relating to motor vehicles; arranging and operating sporting and cultural events; organization of exhibitions for cultural or educational purposes; organisation of competitions (education and entertainment); arranging, organising and conducting competitions for educational or entertainment purposes; arranging, organising and conducting competitions for educational purposes, namely, arranging, organising and conducting academic competitions in the field of innovation, science, technology, engineering and mathematics; arranging, organising and conducting car competitions for educational purposes; arranging, organising and conducting motor vehicles races; organisation of automobile races; organisation of a motor racing team; organisation and supervision of automobile clubs; consultancy, information and advisory services relating to the aforesaid services; all included in Class 41.

- [526] 卸棄 : N/A
Disclaimer:
- [529] 限制 : N/A
Limitation:
- [527] 條件 : N/A
Condition:
其他 : N/A
Others
- [220] 提交日期 : 20-01-2022
Date of Filing:
- [320] 聲稱具有優先權的日期 : N/A
Date of Priority Claimed:
- [310] 優先權申請編號 : N/A
Priority Application Number:
- [340] 聲稱具有優先權 (部分) : N/A
Priority Claim Details:
- [330] 優先權申請的
國家、地區、地方 : N/A
Country, territory, area of
Priority Applications:

[210]	商標申請編號 : Application No.:	305865373
[540]	商標 : Mark:	CHAINLIGHTNING
[550]	商標種類 : Mark Type:	Ordinary
	一系列商標 : Series Mark:	NO
[571]	商標描述 : Mark Description:	N/A
[730]	註冊申請人的姓名 / 名稱、地址 : Applicant(s) ' Name, Address:	Multiverse Labs Pte. Ltd. 79 Robinson Road #07-01 Bridge+ (068897) SINGAPORE
[740/750]	註冊申請人的送達地址 : Applicant's Address for Service:	ACCOLADE IP LIMITED 10/F, Fu Fai Comm. Ctr., 27 Hillier Street, Sheung Wan, HONG KONG
[511]	類別編號 : Class(es) No(s) .:	41
[511]	貨品 / 服務說明 : Specification:	Class 41: Entertainment services; game entertainment services; gaming services; gaming services for entertainment purposes; game services provided online from a computer network; providing on-line information relating to computer gaming entertainment; video and computer game entertainment services; video game entertainment services.
[526]	卸棄 : Disclaimer:	N/A
[529]	限制 : Limitation:	N/A
[527]	條件 : Condition:	N/A
	其他 : Others	N/A
[220]	提交日期 : Date of Filing:	21-01-2022
[320]	聲稱具有優先權的日期 : Date of Priority Claimed:	N/A
[310]	優先權申請編號 : Priority Application Number:	N/A
[340]	聲稱具有優先權 (部分) : Priority Claim Details:	N/A
[330]	優先權申請的	N/A

國家、地區、地方：

Country, territory, area of
Priority Applications:

[210] 商標申請編號： 305865643
Application No.:

[540] 商標：
Mark:

愉愈

[550] 商標種類： 一般商標
Mark Type:
一系列商標： 否
Series Mark:

[571] 商標描述： 不適用
Mark Description:

[730] 註冊申請人的姓名 / 名稱、地址：
Applicant(s) ' Name, Address:
名聲有限公司
香港
九龍尖沙咀漆咸圍 6&8 號
紀德樓地下 8 號舖

[740/ 註冊申請人的送達地址：
750] Applicant's Address for
Service:
中港知識產權有限公司
香港
灣仔告士打道 151 號
資本中心 15 樓 1502 室

[511] 類別編號：
Class(es) No(s) . :
35, 41, 44

[511] 貨品 / 服務說明：
Specification:
類別 41：
畫坊（藝術展覽服務）；組織畫展；舉辦繪畫展覽及比賽；畫廊服務；培訓；組織文化或教育展覽；提供不可下載的在線電子出版物；攝影；人像繪畫服務；繪畫和書法作品出租；籌劃聚會（娛樂）；畫展服務；藝術展覽；為藝術家提供模特服務。

[526] 卸棄：
Disclaimer:
不適用

[529] 限制：
Limitation:
不適用

[527] 條件：
Condition:
不適用

其他：
Others:
不適用

[220] 提交日期：
Date of Filing:
21-01-2022

- [320] 聲稱具有優先權的日期 : 不適用
Date of Priority Claimed:
- [310] 優先權申請編號 : 不適用
Priority Application Number:
- [340] 聲稱具有優先權 (部分) : 不適用
Priority Claim Details:
- [330] 優先權申請的
國家、地區、地方 : 不適用
Country, territory, area of
Priority Applications:

- [210] 商標申請編號 : 305865788
Application No.:

- [540] 商標 :
Mark:

The logo for Curigokids features the brand name in a bold, lowercase, sans-serif font. The letter 'o' in 'gokids' is stylized with a circular graphic element inside it, resembling a camera lens or a stylized eye.

- [550] 商標種類 : Ordinary
Mark Type:
一系列商標 : NO
Series Mark:

- [571] 商標描述 : N/A
Mark Description:

- [730] 註冊申請人的姓名 / 名稱、地址 : CURIOO LIMITED
Applicant(s) ' Suite C, Level 7, World Trust Tower,
Name, Address: 50 Stanley Street, Central
HONG KONG

- [740/ 註冊申請人的送達地址 : RIS GLOBAL INTERNATIONAL LIMITED
750] Applicant's Address for ROOM 1305, 13/F, WINFUL CENTRE
Service: 30 SHING YIP STREET, KWUN TONG
HONG KONG

- [511] 類別編號 : 9, 16, 35, 41, 42
Class(es) No(s) .:

- [511] 貨品 / 服務說明 : Class 41:
Specification: Conducting and arranging of entertainment
exhibitions; arranging and conducting of
colloquiums; production of radio and
television programmes; arranging and
conducting of workshops [training];
entertainment services; Video game services
provided via the Internet; instruction
services; lending library services; teaching;
providing sports facilities; Virtual reality
game services provided on-line from a computer
network

[526]	卸棄: Disclaimer:	N/A
[529]	限制: Limitation:	N/A
[527]	條件: Condition: 其他: Others	N/A
[220]	提交日期: Date of Filing:	22-01-2022
[320]	聲稱具有優先權的日期: Date of Priority Claimed:	N/A
[310]	優先權申請編號: Priority Application Number:	N/A
[340]	聲稱具有優先權 (部分): Priority Claim Details:	N/A
[330]	優先權申請的 國家、地區、地方: Country, territory, area of Priority Applications:	N/A
<hr/>		
[210]	商標申請編號: Application No.:	305865805
[540]	商標: Mark:	
<h1>酷童學</h1>		
[550]	商標種類: Mark Type: 一系列商標: Series Mark:	Ordinary NO
[571]	商標描述: Mark Description:	N/A
[730]	註冊申請人的姓名 / 名稱、地址: Applicant(s)' Name, Address:	CURIOO LIMITED Suite C, Level 7, World Trust Tower, 50 Stanley Street, Central HONG KONG
[740/750]	註冊申請人的送達地址: Applicant's Address for Service:	RIS GLOBAL INTERNATIONAL LIMITED ROOM 1305, 13/F, WINFUL CENTRE 30 SHING YIP STREET, KWUN TONG HONG KONG
[511]	類別編號: Class(es) No(s) .:	16, 41

[511] 貨品 / 服務說明 : Specification:	Class 41: Conducting and arranging of entertainment exhibitions; arranging and conducting of colloquiums; production of radio and television programmes; arranging and conducting of workshops [training]; entertainment services; Video game services provided via the Internet; instruction services; lending library services; teaching; providing sports facilities; Virtual reality game services provided on-line from a computer network
[526] 卸棄 : Disclaimer:	N/A
[529] 限制 : Limitation:	N/A
[527] 條件 : Condition: 其他 : Others	N/A N/A
[220] 提交日期 : Date of Filing:	22-01-2022
[320] 聲稱具有優先權的日期 : Date of Priority Claimed:	N/A
[310] 優先權申請編號 : Priority Application Number:	N/A
[340] 聲稱具有優先權 (部分) : Priority Claim Details:	N/A
[330] 優先權申請的 國家、地區、地方 : Country, territory, area of Priority Applications:	N/A
<hr/> <hr/>	
[210] 商標申請編號 : Application No.:	305866660

[540] 商標：
Mark:



[550] 商標種類： 一般商標
Mark Type:
一系列商標： 否
Series Mark:

[571] 商標描述： 不適用
Mark Description:

[730] 註冊申請人的姓名 / 名稱、地址：
Applicant(s) ' 廈門勇仕網絡技術股份有限公司
Name, Address: 中國
福建省廈門市
湖里區高林中路 535 號 701-713 單元

[740/ 註冊申請人的送達地址：
750] Applicant's Address for 滙誠知識產權有限公司
Service: 香港
灣仔軒尼詩道 8-12 號
中港大廈 8 樓

[511] 類別編號： 41
Class(es) No(s) .:

[511] 貨品 / 服務說明：
Specification: 類別 41:
培訓；組織教育或娛樂競賽；組織電子競技比賽；提供不可下載的在線電子出版物；錄像帶發行；提供不可下載的在線視頻；通過計算機網絡在線提供的遊戲服務；遊戲器具出租；提供虛擬實境遊戲場；教育

[526] 卸棄： 不適用
Disclaimer:

[529] 限制： 不適用
Limitation:

[527] 條件： 不適用
Condition:
其他： 不適用
Others

[220] 提交日期： 24-01-2022
Date of Filing:

[320] 聲稱具有優先權的日期： 不適用
Date of Priority Claimed:

[310] 優先權申請編號： 不適用
Priority Application Number:

[340] 聲稱具有優先權 (部分): 不適用
Priority Claim Details:

[330] 優先權申請的 不適用
國家、地區、地方:
Country, territory, area of
Priority Applications:

[210] 商標申請編號: 305867083
Application No.:

[540] 商標:
Mark:

Alliance Church

[550] 商標種類: Ordinary
Mark Type:
一系列商標: NO
Series Mark:

[571] 商標描述: N/A
Mark Description:

[730] 註冊申請人的姓名 / 名稱、地址: CHRISTIAN & MISSIONARY ALLIANCE CHURCH UNION
Applicant(s) ' HONG KONG LIMITED
Name,Address: G/F, AUSTIN TOWER, C&MA CENTRE
22-26A AUSTIN AVENUE, KOWLOON
HONG KONG

[740/ 註冊申請人的送達地址: MARIE TSANG, DUSTIN CHAN & CO.
750] Applicant's Address for UNITS 2303-04, 23/F., WING ON CENTRE
Service: 111 CONNAUGHT ROAD CENTRAL
HONG KONG

[511] 類別編號: 41
Class(es) No(s) .:

[511] 貨品 / 服務說明: Class 41:
Specification: Conducting guided tours; providing information
in the field of education; providing
information relating to recreational
activities; production of cine-films, video
and/or audio tapes, films, disks, mini discs,
pre-recorded audio or video tapes, cassettes,
compact discs, compact disc read only
memories, digital video discs, digital video
disc read only memories, laser discs;
translation services; rental of films, disks,
mini discs, pre-recorded audio or video tapes,
cassettes, compact discs, compact disc read
only memories, digital video discs, digital
video disc read only memories, laser discs,
video tapes, cine-films, audio tapes, books,
magazines, newspaper, printed matter, texts;
editorial and publication services for books
and texts; know-how transfer training;

tutoring; vocational guidance, education and training; coaching training; songwriting, screenplay writing, consultancy, information and advisory services relating to the foregoing; all included in Class 41.

[526]	卸棄: Disclaimer:	N/A
[529]	限制: Limitation:	N/A
[527]	條件: Condition:	N/A
	其他: Others	N/A
[220]	提交日期: Date of Filing:	25-01-2022
[320]	聲稱具有優先權的日期: Date of Priority Claimed:	N/A
[310]	優先權申請編號: Priority Application Number:	N/A
[340]	聲稱具有優先權 (部分): Priority Claim Details:	N/A
[330]	優先權申請的 國家、地區、地方: Country, territory, area of Priority Applications:	N/A

類別 Class 42

[210] 商標申請編號 : 304649987AB
Application No.:

[540] 商標 :
Mark:



[550] 商標種類 : Ordinary
Mark Type:
一系列商標 : YES
Series Mark:

[571] 商標描述 : The applicant claims the color green as an element of mark "B" in the series.
Mark Description:

[730] 註冊申請人的姓名 / 名稱、地址 : Analogue Holdings Limited
Applicant(s) ' 13/F., Island Place Tower,
Name,Address: 510 King's Road, North Point,
HONG KONG

[740/ 註冊申請人的送達地址 : Benny Kong & Tsai
750] Applicant's Address for Unit 19B, Overseas Trust Bank Building,
Service: No. 160 Gloucester Road, Wanchai,
HONG KONG

[511] 類別編號 : 9,35,42
Class(es) No(s) .:

[511] 貨品 / 服務說明 : Class 42:
Specification: Scientific and technological services and research and design relating thereto; industrial analysis and research services; operating search engines; design of security systems; civil engineering services; mechanical engineering services; storage of data by electronic means; storage of mail messages, telegrams, information and data by mechanical, electronic, telephone, telex, cable, computer and satellite means; storage

of information and data by telephonic and electronic media; rental of electronic storage apparatus.

- [526] 卸棄: N/A
Disclaimer:
- [529] 限制: N/A
Limitation:
- [527] 條件: N/A
Condition:
其他: By consent, registration no. 303952558
Others
- [220] 提交日期: 28-08-2018
Date of Filing:
- [320] 聲稱具有優先權的日期: N/A
Date of Priority Claimed:
- [310] 優先權申請編號: N/A
Priority Application Number:
- [340] 聲稱具有優先權 (部分): N/A
Priority Claim Details:
- [330] 優先權申請的
國家、地區、地方: N/A
Country, territory, area of
Priority Applications:

- [210] 商標申請編號: 304766978
Application No.:
- [540] 商標: 
Mark:
- [550] 商標種類: 一般商標
Mark Type:
一系列商標: 否
Series Mark:
- [571] 商標描述: 不適用
Mark Description:
- [730] 註冊申請人的姓名 / 名稱、地址: 環球首飾有限公司 (Universal Jewellery Company Limited)
Applicant(s) ' Name, Address: 香港
中環德己立街 38-44 號
好利商業大廈 17 樓
- [740/ 註冊申請人的送達地址: CTR PRODUCT DEVELOPMENT LIMITED
750] Applicant's Address for Service: 香港
九龍灣宏光道 8 號
創豪坊 7 樓 706 室

[511] 類別編號 : 14, 35, 42
Class(es) No(s) .:

[511] 貨品 / 服務說明 : 類別 42:
Specification: 服裝設計。

[526] 卸棄 : 不適用
Disclaimer:

[529] 限制 : 不適用
Limitation:

[527] 條件 : 不適用
Condition:

其他 : 不適用
Others

[220] 提交日期 : 12-12-2018
Date of Filing:

[320] 聲稱具有優先權的日期 : 不適用
Date of Priority Claimed:

[310] 優先權申請編號 : 不適用
Priority Application Number:

[340] 聲稱具有優先權 (部分) : 不適用
Priority Claim Details:

[330] 優先權申請的
國家、地區、地方 : 不適用
Country, territory, area of
Priority Applications:

[210] 商標申請編號 : 304803516
Application No.:

[540] 商標 :
Mark:

Panasonic
Lifestyle Updates

[550] 商標種類 : Ordinary
Mark Type:

一系列商標 : NO
Series Mark:

[571] 商標描述 : N/A
Mark Description:

[730] 註冊申請人的姓名 / 名稱、地址 : Panasonic Kabushiki Kaisha (Panasonic
Applicant(s) ' Corporation)
Name, Address: 1006, Oaza Kadoma,
Kadoma-shi, Osaka 571-8501,
JAPAN

[740/ 註冊申請人的送達地址 : MARKS & CLERK
750] Applicant's Address for Level 9, Cyberport 1
Service:

100 Cyberport Road, Pok Fu Lam
HONG KONG

[511] 類別編號 : 7, 8, 9, 10, 11, 20, 35, 36, 37, 42

Class(es) No(s) .:

[511] 貨品 / 服務說明 :

Specification:

Class 42:

Scientific and technological services and research and design relating thereto; Industrial analysis and research services; Design and development of computer hardware and software; Computer software design; Computer programming; Maintenance of computer software; Computer system design; Configuration of computer systems; Testing and research services relating to electric and electronic machines, apparatus and instruments; Computer rental; Providing temporary use of non-downloadable computer software; Website design; Hosting computer sites [websites]; Updating of computer software; Recovery of computer data; Computer services; Hosting and maintaining the websites of others; File sharing services, namely, providing a website featuring technology enabling users to upload and download electronic files; Photo sharing services, namely, providing a website featuring technology enabling users to upload, view, and download digital photos; Providing non-downloadable computer software for use in digital image processing; Providing non-downloadable computer software for browsing information on the Internet; Electronic data storage; Rental of electronic storage space on the Internet; Rental of web servers; Providing meteorological information; Technical advice relating to operation of computers, automobiles and other machines, apparatus and instruments; Testing and research services in the field of electricity; Architectural design; Designing; Cartography and mapping services; Providing a website featuring technology enabling users to upload and download electronic files; Providing a website featuring technology enabling users to edit photos, create photo albums and upload photos and photo albums; Providing a website featuring technology that enables online electronic conference systems via cloud computing; Computer diagnostic services; Providing computer systems for remote desktop solutions through cloud computing; Computer system monitoring and maintenance; Computer system design and installation; Computer system technical support services; Technical advice relating to equipment inspection;

Technical advice relating to information security diagnosis; Technical advice relating to assessment of information security vulnerability; Technical advice relating to data and information analysis; Technical advice relating to cloud computing; Technical advice relating to business information security and protection; Technical advice relating to Internet of Things (IoT); Technical advice relating to machine-to-machine (M2M) communication; Technical advice relating to digital content distribution; Technical advice relating to identification and authentication of persons; Technical advice relating to billing in electronic commerce transactions; Technical advice relating to remote video monitoring; Technical advice relating to operation and control of plant factory systems; Technical advice relating to operation and control of agricultural apparatus and systems; Technical advice relating to management and control of plant cultivation; Technical advice relating to operation and control of water treatment systems; Technical advice relating to monitoring of air contaminants and pollutants; Technical advice relating to visualization and analysis of air flow; Technical advice relating to operation and control of autonomous-driving vehicles; Design, development and maintenance of computer systems and software for remote access to computer terminals and networks; Design, development and maintenance of computer systems and software for scanning, detecting and eliminating of viruses, spyware and malware; Design, development and maintenance of computer systems and software for search, analysis and detection of security incidents and access logs; Design, development and maintenance of computer systems and software for assessment of information security vulnerability; Design, development and maintenance of computer systems and software for data and information analysis; Design, development and maintenance of computer systems and software for cloud computing; Design, development and maintenance of computer systems and software for sales management; Design, development and maintenance of computer systems and software for computer database searches; Design, development and maintenance of computer systems and software for providing storage, archiving, backup, and management of electronic data via network connection;

Design, development and maintenance of computer systems and software for detecting and analyzing the presence of individuals or objects; Design, development and maintenance of computer systems and software for detecting and analyzing the location, staying time and moving route of individuals or objects; Design, development and maintenance of computer systems and software for computer file management; Design, development and maintenance of computer systems and software for VLC (visible light communications) for the transmission of electronic data, namely video, music, image, text and sound; Design, development and maintenance of computer systems and software for Internet of Things (IoT); Design, development and maintenance of computer systems and software for machine-to-machine (M2M) communication; Design, development and maintenance of computer systems and software for video surveillance; Design, development and maintenance of computer systems and software for text-to-speech converting; Design, development and maintenance of computer systems and software for remote video monitoring; Design, development and maintenance of computer systems and software for management of customer information; Design, development and maintenance of computer systems and software for point-of-sales [POS] systems; Design, development and maintenance of computer systems and software for operation and control of plant factory systems; Software as a service [SaaS]; Software as a service [SaaS] for management and control of mobile computer or communication devices; Software as a service [SaaS] for data storage management; Software as a service [SaaS] for scanning, detecting and eliminating of viruses, spyware and malware; Software as a service [SaaS] for data and information analysis; Software as a service [SaaS] for cloud computing; Software as a service [SaaS] for sales management; Software as a service [SaaS] for client and customer management; Software as a service [SaaS] for detecting and analyzing the presence of individuals or objects; Software as a service [SaaS] for detecting and analyzing the location, staying time and moving route of individuals or objects; Software as a service [SaaS] for Internet of Things (IoT); Software as a service [SaaS] for machine-to-machine (M2M) communication; Software as a service [SaaS] for digital content distribution; Software as a service

[SaaS] for text-to-speech converting; Software as a service [SaaS] for computerized production management; Software as a service [SaaS] for remote video monitoring; Software as a service [SaaS] for management of customer information; Software as a service [SaaS] for point-of-sales [POS] systems; Software as a service [SaaS] for virtual reality image processing; Analysis of computer database performance; Cloud computing; Consultancy relating to cloud computing; Digitization of documents [scanning]; Infrastructure as a Service [IaaS]; Server administration; Design, development and hosting of computer databases; Electronic storage of archived data; Data security services [firewalls]; Technical verification and validation of product operation; Technical verification and validation of computer networks; Technical verification and validation of computer systems; Product design; Analysis and evaluation of products; Structural analysis and evaluation of buildings; Materials testing and analyzing; Chemical testing, analysis and evaluation services; Testing and analysis of network connection; Consultancy relating to research and development of products; Technical inspection services; Consultancy relating to design, programming and maintenance of computer software; Creating web sites for others; Rental of computer software; Technical consultancy relating to the design of computer hardware, software and computer peripherals; Computer technology consultancy; Hosting platforms on the Internet; Installation of computer software; Design of telecommunication machines and apparatus and radio communication machines and apparatus, and consultancy relating to such design; Design and development of computer hardware, software and databases; Rental of memory space for servers on the internet; Rental of computer servers; Rental of measuring or testing machines and instruments; Engineering relating to measuring or testing machines and instruments; Design of measuring or testing machines and instruments; Design and development of navigation systems; Architectural research; Research on city planning; Testing or research on prevention of pollution; Testing or research on electricity; Testing or research on civil engineering; Conducting surveys on energy consumption and providing information thereof; Consultancy and information in the field of energy saving and efficiency; Surveying; Architectural services;

Construction drafting; Architectural consultation; Providing information in the field of architectural design; Geological surveys or research; Design of building interiors and exteriors; Monitoring of computer systems by remote access; Consulting services in the fields of energy consumption and usage conservation to improve energy efficiency; Research and development of new products for others.

- [526] 卸棄 : N/A
Disclaimer:
- [529] 限制 : N/A
Limitation:
- [527] 條件 : N/A
Condition:
其他 : N/A
Others
- [220] 提交日期 : 16-01-2019
Date of Filing:
- [320] 聲稱具有優先權的日期 : N/A
Date of Priority Claimed:
- [310] 優先權申請編號 : N/A
Priority Application Number:
- [340] 聲稱具有優先權 (部分) : N/A
Priority Claim Details:
- [330] 優先權申請的
國家、地區、地方 : N/A
Country, territory, area of
Priority Applications:

-
-
- [210] 商標申請編號 : 304834486
Application No.:

- [540] 商標 :
Mark:

PATTERN

- [550] 商標種類 : Ordinary
Mark Type:
一系列商標 : NO
Series Mark:

- [571] 商標描述 : N/A
Mark Description:

- [730] 註冊申請人的姓名 / 名稱、地址 :
Applicant(s) ' PATTERN INC.
Name, Address: 1633 W INNOVATION WAY STE 300
LEHI, UTAH 84043
UNITED STATES OF AMERICA

[740/ 註冊申請人的送達地址 : DORSEY & WHITNEY
750] Applicant's Address for SUITE 3008, ONE PACIFIC PLACE
Service: 88 QUEENSWAY
HONG KONG

[511] 類別編號 : 35,41,42
Class(es) No(s) .:

[511] 貨品 / 服務說明 : Class 42:
Specification: (A) Software as a service (SAAS) services featuring software for minimum advertised price (MAP) compliance and sales management; (B) computer software design for minimum advertised price (MAP) compliance and sales management; maintenance and updating of computer software for minimum advertised price (MAP) compliance and sales management; computer programming for minimum advertised price (MAP) compliance and sales management; creating and maintaining web sites for others in the field of e-commerce; technical research; design and development of multimedia products; quality control; surveying; chemical analysis; clinical trials; weather forecasting; material testing; industrial design; architectural services; dress designing; authenticating works of art; graphic arts design; cloud seeding; handwriting analysis [graphology]; cartography services; intangible assets appraisal (quality evaluation); weighing goods for others.

[526] 卸棄 : N/A
Disclaimer:

[529] 限制 : N/A
Limitation:

[527] 條件 : N/A
Condition:
其他 : N/A
Others

[220] 提交日期 : 20-02-2019
Date of Filing:

[320] 聲稱具有優先權的日期 : 14-11-2018
Date of Priority Claimed:

[310] 優先權申請編號 : 88194208
Priority Application Number:

[340] 聲稱具有優先權 (部分) : For services listed in (A) in Classes 35, 41
Priority Claim Details: and 42

[330] 優先權申請的 UNITED STATES OF AMERICA
國家、地區、地方 :
Country, territory, area of
Priority Applications:

[210] 商標申請編號 : 305085144
Application No.:

[540] 商標 :
Mark:

SEEK

[550] 商標種類 : Ordinary
Mark Type:
一系列商標 : NO
Series Mark:

[571] 商標描述 : N/A
Mark Description:

[730] 註冊申請人的姓名 / 名稱、地址 : Seek Limited
Applicant(s) ' 541 St Kilda Road
Name, Address: Melbourne Victoria 3004
AUSTRALIA

[740/ 註冊申請人的送達地址 : SO KEUNG YIP & SIN
750] Applicant's Address for Room 1009-1012, 10/F., Nan Fung Tower,
Service: No. 173 Des Voeux Road Central
HONG KONG

[511] 類別編號 : 9, 16, 35, 36, 37, 38, 41, 42, 45
Class(es) No(s) .:

[511] 貨品 / 服務說明 : Class 42:
Specification: Scientific and technological services and research and design relating thereto; industrial analysis and research services; design and development of computer hardware and software; creating indexes of online information; providing a search engine for job and employment listings; provision of search engines for obtaining data via communications networks, including data in connection with educational and vocational training courses; creating virtual communities for users to participate in discussions regarding various educational and vocational training courses; provision of software as a service (SaaS); provision of online non-downloadable software (application service provider); application service provider featuring application programming interface software; computer services including the creation of virtual communities for users to engage in business and employment related networking; hosting electronic facilities for others to organise and conduct meetings, events and interactive discussions via communication networks; application service provider (ASP) services featuring software to enable or facilitate the uploading, streaming, posting, displaying, linking, sharing of or otherwise providing electronic media or information over communication networks; Hosting online network

services or PaaS (Platform as a Service) enabling users to share personal, employment and business identity data through a communication platform; web portal services (designing or hosting); internet portal services (designing or hosting); consultancy, information and advisory services regarding the aforementioned services

- [526] 卸棄 : N/A
Disclaimer:
- [529] 限制 : N/A
Limitation:
- [527] 條件 : N/A
Condition:
其他 : By consent, No. 304489868
Others
- [220] 提交日期 : 16-10-2019
Date of Filing:
- [320] 聲稱具有優先權的日期 : N/A
Date of Priority Claimed:
- [310] 優先權申請編號 : N/A
Priority Application Number:
- [340] 聲稱具有優先權 (部分) : N/A
Priority Claim Details:
- [330] 優先權申請的
國家、地區、地方 : N/A
Country, territory, area of
Priority Applications:

- [210] 商標申請編號 : 305085153
Application No.:
- [540] 商標 :
Mark:



- [550] 商標種類 : Ordinary
Mark Type:
一系列商標 : NO
Series Mark:
- [571] 商標描述 : N/A
Mark Description:
- [730] 註冊申請人的姓名 / 名稱、地址 : Seek Limited
Applicant (s) ' 541 St Kilda Road
Name, Address: Melbourne Victoria 3004
AUSTRALIA

[740/ 註冊申請人的送達地址 : SO KEUNG YIP & SIN
750] Applicant's Address for Room 1009-1012, 10/F., Nan Fung Tower,
Service: No. 173 Des Voeux Road Central
HONG KONG

[511] 類別編號 : 9,16,35,36,37,38,41,42,45
Class(es) No(s) .:

[511] 貨品 / 服務說明 : Class 42:
Specification: Scientific and technological services and
research and design relating thereto;
industrial analysis and research services;
design and development of computer hardware
and software; creating indexes of online
information; providing a search engine for job
and employment listings; provision of search
engines for obtaining data via communications
networks, including data in connection with
educational and vocational training courses;
creating virtual communities for users to
participate in discussions regarding various
educational and vocational training courses;
provision of software as a service (SaaS);
provision of online non-downloadable software
(application service provider); application
service provider featuring application
programming interface software; computer
services including the creation of virtual
communities for users to engage in business
and employment related networking; hosting
electronic facilities for others to organise
and conduct meetings, events and interactive
discussions via communication networks;
application service provider (ASP) services
featuring software to enable or facilitate the
uploading, streaming, posting, displaying,
linking, sharing of or otherwise providing
electronic media or information over
communication networks; Hosting online network
services or PaaS (Platform as a Service)
enabling users to share personal, employment
and business identity data through a
communication platform; web portal services
(designing or hosting); internet portal
services (designing or hosting); consultancy,
information and advisory services regarding
the aforementioned services

[526] 卸棄 : N/A
Disclaimer:

[529] 限制 : N/A
Limitation:

[527] 條件 : N/A
Condition:
其他 : By consent, No. 304489868
Others

[220] 提交日期 : 16-10-2019
Date of Filing:

[320] 聲稱具有優先權的日期 : N/A
Date of Priority Claimed:

[310] 優先權申請編號 : N/A
Priority Application Number:

[340] 聲稱具有優先權 (部分) : N/A
Priority Claim Details:

[330] 優先權申請的
國家、地區、地方 : N/A
Country, territory, area of
Priority Applications:

[210] 商標申請編號 : 305453992
Application No.:

[540] 商標 :
Mark:



[550] 商標種類 : 一般商標
Mark Type:

一系列商標 : 否
Series Mark:

[571] 商標描述 : 不適用
Mark Description:

[730] 註冊申請人的姓名/名稱、地址 : 阿拉梅達研究有限責任公司 (ALAMEDA RESEARCH LLC)
Applicant(s) ' 美國
Name, Address: 加利福尼亞州
伯克利中心街 2000 號 400 室, 郵編 94704

[740/ 註冊申請人的送達地址 : DEACONS
750] Applicant's Address for 5th Floor,
Service: Alexandra House Central
HONG KONG

[511] 類別編號 : 9, 35, 36, 41, 42
Class(es) No(s) .:

[511] 貨品/服務說明 : 類別 42:
Specification: (A) 技術研究; 科學研究; 計算機編程; 計算機軟件設計; 計算機系統設計; 計算機軟件出租; 計算機軟件更新; 計算機軟件維護; 計算機硬件設計和開發諮詢; 信息技術諮詢服務; 軟件即服務 (SaaS); 雲計算; 數據安全諮詢; 平台即服務 (PaaS); 計算機平台的開發; 多媒體產品的設計和開發; 數據庫設計和開發。(B) 提供線上不可下載軟體之暫時使用; 計算機平台的開發 (用於數字貨幣交易); 無形資產評估。

[526] 卸棄 : 不適用
Disclaimer:

[529] 限制 : 不適用
Limitation:

[527] 條件:		不適用	
Condition:			
其他:		不適用	
Others			
[220] 提交日期:		19-11-2020	
Date of Filing:			
[320] 聲稱具有優先權的日期:	[310] 優先權申請編號:	[340] 聲稱具有優先權 (部分):	[330] 優先權申請的
Date of Priority Claimed:	Priority Application No.:	Priority Claim Details:	國家、地區、地方:
			Country, territory, area of Priority Applications:
28-05-2020	46751586	適用於類別 9 內 (A) 項貨品	中國
28-05-2020	46725736	適用於類別 35 內 (A) 項服務	中國
28-05-2020	46732302	適用於類別 36 內 (A) 項服務	中國
28-05-2020	46733784	適用於類別 41 內 (A) 項服務	中國
28-05-2020	46759885	適用於類別 42 內 (A) 項服務	中國

[210] 商標申請編號: 305454009
Application No.:

[540] 商標: 
Mark:

[550] 商標種類: 一般商標
Mark Type:
一系列商標: 否
Series Mark:

[571] 商標描述: 不適用
Mark Description:

[730] 註冊申請人的姓名/名稱、地址: 阿拉梅達研究有限責任公司 (ALAMEDA RESEARCH LLC)
Applicant(s) Name, Address: 美國

加利福尼亞州
伯克利中心街 2000 號 400 室，郵編 94704

[740/ 註冊申請人的送達地址 : DEACONS
750] Applicant's Address for 5th Floor,
Service: Alexandra House Central
HONG KONG
[511] 類別編號 : 9, 35, 36, 41, 42
Class(es) No(s) . :
[511] 貨品/服務說明 : 類別 42:
Specification: (A) 技術研究; 科學研究; 計算機編程; 計算機軟件設計; 計算機系統設計; 計算機軟件出租; 計算機軟件更新; 計算機軟件維護; 計算機硬件設計和開發諮詢; 信息技術諮詢服務; 軟件即服務 (SaaS); 雲計算; 數據安全諮詢; 平台即服務 (PaaS); 計算機平台的開發; 多媒體產品的設計和開發; 數據庫設計和開發。(B) 提供線上不可下載軟體之暫時使用; 計算機平台的開發 (用於數字貨幣交易); 無形資產評估。
[526] 卸棄 : 不適用
Disclaimer:
[529] 限制 : 不適用
Limitation:
[527] 條件 : 不適用
Condition:
其他 : 不適用
Others
[220] 提交日期 : 19-11-2020
Date of Filing:
[320] [310] [340] [330]
聲稱具有優先權的日期 : 優先權申請編號 : 聲稱具有優先權 (部分) : 優先權申請的
Date of Priority Priority Application Priority Claim 國家、地區、地方 :
Claimed: No. : Details: Country, territory, area of Priority Applications:
28-05-2020 46759648 適用於類別 9 內 (A) 項貨品 中國
28-05-2020 46750650 適用於類別 35 內 (A) 項服務 中國
28-05-2020 46729087 適用於類別 36 內 (A) 項服務 中國
28-05-2020 46736855 適用於類別 41 內 (A) 項服務 中國
28-05-2020 46732326 適用於類別 42 內 (A) 項服務 中國

[210]	商標申請編號 : Application No.:	305600349
[540]	商標 : Mark:	<h1>苏氏研创院</h1>
[550]	商標種類 : Mark Type:	Ordinary
	一系列商標 : Series Mark:	NO
[571]	商標描述 : Mark Description:	N/A
[730]	註冊申請人的姓名 / 名稱、地址 : Applicant(s) ' Name, Address:	Chimelong International Investment Company Limited Vistra Corporate Services Centre, Wickhams Cay II Road Town, Tortola, VG1110 VIRGIN ISLANDS (BRITISH)
[740/750]	註冊申請人的送達地址 : Applicant's Address for Service:	BENNY KONG & TSAI Unit 19B, Overseas Trust Bank Building No. 160 Gloucester Road, Wanchai HONG KONG
[511]	類別編號 : Class(es) No(s) .:	39, 41, 42, 43
[511]	貨品 / 服務說明 : Specification:	Class 42: Research and development of new products for others; Engineering design services; Design and development of multimedia products; quality testing; surveying; industrial design; toy design; packaging design; dress designing; computer software design; animation design for others; graphic arts design; cartography services; Provide set design services for the theater company; interior design; Product testing
[526]	卸棄 : Disclaimer:	N/A
[529]	限制 : Limitation:	N/A
[527]	條件 : Condition:	N/A
	其他 : Others	N/A
[220]	提交日期 : Date of Filing:	21-04-2021
[320]	聲稱具有優先權的日期 : Date of Priority Claimed:	N/A
[310]	優先權申請編號 :	N/A

Priority Application Number:

[340] 聲稱具有優先權 (部分): N/A

Priority Claim Details:

[330] 優先權申請的 N/A

國家、地區、地方:

Country, territory, area of

Priority Applications:

[210] 商標申請編號: 305603698

Application No.:

[540] 商標:

Mark:

百佳荟外贸家

[550] 商標種類: 一般商標

Mark Type:

一系列商標:

否

Series Mark:

[571] 商標描述: 不適用

Mark Description:

[730] 註冊申請人的姓名 / 名稱、地址:

杭州百佳荟對外貿易集團有限公司

Applicant(s) '

中國

Name, Address:

浙江省杭州市

余杭區倉前街道文一西路 1218 號 35 幢 1 單元 501 室

[740/ 註冊申請人的送達地址:

中港知識產權有限公司

750] Applicant's Address for

香港

Service:

灣仔告士打道 151 號

資本中心 15 樓 1502 室

9, 35, 38, 41, 42

[511] 類別編號:

Class(es) No(s) .:

[511] 貨品 / 服務說明:

類別 42:

Specification:

平臺即服務 (PaaS); 軟件即服務 (SaaS); 計算機編程;
計算機軟件出租; 應用軟件出租; 把有形的數據或文件轉換成
電子媒體; 提供互聯網搜索引擎; 計算機軟件設計; 替他人創
建或維護網站; 網站託管服務; 計算機平臺的開發; 通過技術
手段為電子商務交易進行用戶認證服務; 技術研究; 藝術品鑒
定; 包裝設計。

[526] 卸棄:

不適用

Disclaimer:

[529] 限制:

不適用

Limitation:

[527] 條件:

不適用

Condition:

其他:

不適用

Others

[220] 提交日期: 23-04-2021
Date of Filing:
[320] 聲稱具有優先權的日期: 不適用
Date of Priority Claimed:
[310] 優先權申請編號: 不適用
Priority Application Number:
[340] 聲稱具有優先權 (部分): 不適用
Priority Claim Details:
[330] 優先權申請的 不適用
國家、地區、地方:
Country, territory, area of
Priority Applications:

[210] 商標申請編號: 305603706
Application No.:

[540] 商標:
Mark:



[550] 商標種類: 一般商標
Mark Type:
一系列商標: 否
Series Mark:

[571] 商標描述: 不適用
Mark Description:

[730] 註冊申請人的姓名 / 名稱、地址: 杭州百佳荟對外貿易集團有限公司
Applicant(s) ' 中國
Name, Address: 浙江省杭州市

[740/ 註冊申請人的送達地址: 余杭區倉前街道文一西路 1218 號 35 幢 1 單元 501 室
750] Applicant's Address for 中港知識產權有限公司
Service: 香港

[511] 類別編號: 9, 35, 38, 41, 42
Class(es) No(s) .: 資本中心 15 樓 1502 室

[511] 貨品 / 服務說明: 類別 42:
Specification: 平臺即服務 (PaaS); 軟件即服務 (SaaS); 計算機編程;
計算機軟件出租; 應用軟件出租; 把有形的數據或文件轉換成
電子媒體; 提供互聯網搜索引擎; 計算機軟件設計; 替他人創
建或維護網站; 網站託管服務; 計算機平臺的開發; 通過技術
手段為電子商務交易進行用戶認證服務; 技術研究; 藝術品鑒
定; 包裝設計。

[526] 卸棄: 不適用
Disclaimer:

[529] 限制:	不適用
Limitation:	
[527] 條件:	不適用
Condition:	
其他:	不適用
Others	
[220] 提交日期:	23-04-2021
Date of Filing:	
[320] 聲稱具有優先權的日期:	不適用
Date of Priority Claimed:	
[310] 優先權申請編號:	不適用
Priority Application Number:	
[340] 聲稱具有優先權 (部分):	不適用
Priority Claim Details:	
[330] 優先權申請的 國家、地區、地方:	不適用
Country, territory, area of Priority Applications:	
<hr/>	
[210] 商標申請編號:	305613543
Application No.:	
[540] 商標:	LELLOBEE
Mark:	
[550] 商標種類:	Ordinary
Mark Type:	
一系列商標:	NO
Series Mark:	
[571] 商標描述:	N/A
Mark Description:	
[730] 註冊申請人的姓名 / 名稱、地址:	Moonbug Entertainment Limited
Applicant(s) 'Name, Address:	Labs Upper Lock 2nd Floor 3-6 Water Lane Camden Town London NW1 8JZ UNITED KINGDOM
[740/ 註冊申請人的送達地址:	BENNY KONG & TSAI
750] Applicant's Address for Service:	Unit 19B, Overseas Trust Bank Building No. 160 Gloucester Road, Wanchai HONG KONG
[511] 類別編號:	3, 5, 8, 9, 10, 11, 12, 14, 15, 16, 18, 20, 21, 24, 25, 26, 27 , 28, 29, 30, 32, 35, 41, 42, 43
Class(es) No(s) .:	
[511] 貨品 / 服務說明:	Class 42:
Specification:	Scientific and technological services and research and design relating thereto; industrial analysis, industrial research and industrial design services; quality control and authentication services; design and

development of computer hardware and software;
design and development of computer hardware
and software; providing alerts regarding
children's access to online websites and
content (computer services).

- [526] 卸棄 : N/A
Disclaimer:
- [529] 限制 : N/A
Limitation:
- [527] 條件 : N/A
Condition:
其他 : N/A
Others
- [220] 提交日期 : 03-05-2021
Date of Filing:
- [320] 聲稱具有優先權的日期 : N/A
Date of Priority Claimed:
- [310] 優先權申請編號 : N/A
Priority Application Number:
- [340] 聲稱具有優先權 (部分) : N/A
Priority Claim Details:
- [330] 優先權申請的
國家、地區、地方 : N/A
Country, territory, area of
Priority Applications:

- [210] 商標申請編號 : 305622020
Application No.:

- [540] 商標 : **CONNECTIVITY STANDARDS
ALLIANCE**
Mark:

- [550] 商標種類 : Ordinary
Mark Type:
一系列商標 : NO
Series Mark:

- [571] 商標描述 : N/A
Mark Description:

- [730] 註冊申請人的姓名 / 名稱、地址 : Zigbee Alliance
Applicant(s) ' 508 Second Street, Suite 206
Name,Address: Davis, California 95616
UNITED STATES OF AMERICA

- [740/ 註冊申請人的送達地址 : DLA PIPER HONG KONG
750] Applicant's Address for 25th Floor, Three Exchange Square,
Service: 8 Connaught Place, Central,
HONG KONG

- [511] 類別編號 : 9, 35, 41, 42
Class(es) No(s) .:
- [511] 貨品 / 服務說明 :
Specification: Class 42:
Online non-downloadable software for testing, certification of analytics of interoperability standards; software as a service (SaaS) for testing, certification of analytics of interoperability standards; technical (technological) consulting services in the fields of interoperability standards, wireless standards and wireless communication; technical research and design services in the fields of interoperability standards, wireless standards and wireless communication; technical research and design in the fields of consumer electronics, environmental controls, and remote monitoring of electronic products; technical (technological) analysis services in the field of interoperability standards, wireless standards and wireless communication; providing a website featuring technological information in the fields of interoperability standards, wireless standards and wireless communication; providing a website featuring technological information for members of an interoperability standards organization.
- [526] 卸棄 : N/A
Disclaimer:
- [529] 限制 : N/A
Limitation:
- [527] 條件 : N/A
Condition:
其他 : N/A
Others
- [220] 提交日期 : 12-05-2021
Date of Filing:
- [320] 聲稱具有優先權的日期 : 22-03-2021
Date of Priority Claimed:
- [310] 優先權申請編號 : 90593533
Priority Application Number:
- [340] 聲稱具有優先權 (部分) : N/A
Priority Claim Details:
- [330] 優先權申請的
國家、地區、地方 : UNITED STATES OF AMERICA
Country, territory, area of
Priority Applications:
-
- [210] 商標申請編號 : 305623768
Application No.:

[540] 商標 :
Mark:

A



B



[550] 商標種類 : Ordinary
Mark Type:
一系列商標 : YES
Series Mark:
[571] 商標描述 : The applicant claims the colours navy blue and white as elements of mark A in the series.
Mark Description:
[730] 註冊申請人的姓名 / 名稱、地址 : CliftonLarsonAllen, LLP
Applicant(s) ' Suite 300, 220 South Sixth Street
Name,Address: Minneapolis, MINNESOTA 554021926
UNITED STATES OF AMERICA
[740/ 註冊申請人的送達地址 : MARKS & CLERK
750] Applicant's Address for Level 9, Cyberport 1
Service: 100 Cyberport Road, Pok Fu Lam
HONG KONG
[511] 類別編號 : 9,16,35,36,41,42,45
Class(es) No(s) .:
[511] 貨品 / 服務說明 : Class 42:
Specification: Computer consulting services regarding accounting software selection, and implementation of accounting software; technology consulting services in the field of technology planning regarding computers, software, office equipment, communications equipment, and networks; computer consulting

services in the field of design, selection, implementation and use of computer hardware and software systems for others; consultation regarding business software and computer networks; installation of computer software; technical support services, namely, performing systems monitoring, system audits, system inventory, regularly scheduled system maintenance; litigation support services; providing temporary use of an on-line non-downloadable customized software program that allows interactive modeling of future financial performance projections assuming various combinations of success related to an organization's key business performance drivers; managed service provider (MSP) services, namely, remote management of IT systems; all included in Class 42.

- [526] 卸棄 : N/A
Disclaimer:
- [529] 限制 : N/A
Limitation:
- [527] 條件 : N/A
Condition:
其他 : N/A
Others
- [220] 提交日期 : 13-05-2021
Date of Filing:
- [320] 聲稱具有優先權的日期 : 13-04-2021
Date of Priority Claimed:
- [310] 優先權申請編號 : 90642163
Priority Application Number:
- [340] 聲稱具有優先權 (部分) : For mark "A" in the series.
Priority Claim Details:
- [330] 優先權申請的
國家、地區、地方 : UNITED STATES OF AMERICA
Country, territory, area of
Priority Applications:
-
-

- [210] 商標申請編號 : 305629609
Application No.:
- [540] 商標 :
Mark:

集度 JIDU

[550]	商標種類 :	一般商標		
	Mark Type:			
	一系列商標 :	否		
	Series Mark:			
[571]	商標描述 :	不適用		
	Mark Description:			
[730]	註冊申請人的姓名/名稱、地址 :	南寧朵有米文化傳媒有限公司		
	Applicant(s) ' Name, Address:	中國 廣西壯族自治區南寧市 西鄉塘區大學東路 98 號世貿西城廣場 B 區 F 座 2302 號		
[740/750]	註冊申請人的送達地址 : Applicant's Address for Service:	CHANG TSI AND PARTNERS INTELLECTUAL PROPERTY (HK) LIMITED 香港 中環金融街 8 號 國際金融中心二期 19 樓		
[511]	類別編號 :	9, 12, 37, 42		
	Class(es) No(s) .:			
[511]	貨品/服務說明 :	類別 42:		
	Specification:	質量檢測; 化妝品研究; 車輛性能檢測; 技術研究; 計算機軟件設計; 平面美術設計; 工業品外觀設計; 室內裝飾設計; 藝術品鑒定; 測量。		
[526]	卸棄 :	不適用		
	Disclaimer:			
[529]	限制 :	不適用		
	Limitation:			
[527]	條件 :	不適用		
	Condition:			
	其他 :	不適用		
	Others			
[220]	提交日期 :	20-05-2021		
	Date of Filing:			
[320]	聲稱具有優先權的日期 :	[310] 優先權申請編號 :	[340] 聲稱具有優先權 (部分) :	[330] 優先權申請的
	Date of Priority Claimed:	Priority Application No.:	Priority Claim Details:	國家、地區、地方 :
				Country, territory, area of Priority Applications:
14-01-2021	52988285		就類別 12	中國
15-01-2021	53017318		就類別 9	中國
15-01-2021	53019448		就類別 37	中國
15-01-2021	53019768		就類別 42	中國

[210] 商標申請編號 : 305636845AA
Application No.:

[540] 商標 :
Mark:

CKH IOD

[550] 商標種類 : Ordinary
Mark Type:
一系列商標 : NO
Series Mark:

[571] 商標描述 : N/A
Mark Description:

[730] 註冊申請人的姓名 / 名稱、地址 : Palmerston Limited
Applicant(s) ' 1st Floor, Sixty Circular Road,
Name,Address: Douglas,
ISLE OF MAN

[740/ 註冊申請人的送達地址 : Hutchison Whampoa Agents Limited
750] Applicant's Address for 48th Floor, Cheung Kong Center,
Service: 2 Queen's Road Central
HONG KONG

[511] 類別編號 : 9, 35, 38, 42, 45
Class(es) No(s) .:

[511] 貨品 / 服務說明 :
Specification:

Class 42:
Monitoring of network systems (for others);
computer network services; computer network
configuration services; development of
computer networks; computer software
development and implementation; computer
software programming; rental and leasing of
computer software and hardware; consultancy in
the fields of telecommunications technology
and computing networks; integration of
computer systems and networks; computer
software and information technology technical
support services; support and maintenance
services for computer software; hosting of web
sites of others; computer services, namely,
computer support services, computer diagnostic
services, computer network configuration
services, computer system integration
services, computer system monitoring services,
computer network services, troubleshooting for
computer networks, computer security services;
cloud hosting provider services; computer
services provided online from the internet;
all the aforesaid services relating to the
operation of telecommunications networks; none
of the aforesaid services in relation to
business information, business training,
business networking, professional development
courses, professional development events and
setting standards for corporate governance.

[526] 卸棄:	N/A
Disclaimer:	
[529] 限制:	N/A
Limitation:	
[527] 條件:	N/A
Condition:	
其他:	N/A
Others	
[220] 提交日期:	26-05-2021
Date of Filing:	
[320] 聲稱具有優先權的日期:	04-05-2021
Date of Priority Claimed:	
[310] 優先權申請編號:	UK00003636391
Priority Application Number:	
[340] 聲稱具有優先權 (部分):	N/A
Priority Claim Details:	
[330] 優先權申請的 國家、地區、地方:	UNITED KINGDOM
Country, territory, area of Priority Applications:	
<hr/>	
[210] 商標申請編號:	305636845AB
Application No.:	
[540] 商標:	CKHIOD
Mark:	
[550] 商標種類:	Ordinary
Mark Type:	
一系列商標:	NO
Series Mark:	
[571] 商標描述:	N/A
Mark Description:	
[730] 註冊申請人的姓名 / 名稱、地址:	Palmerston Limited
Applicant(s)' Name, Address:	1st Floor, Sixty Circular Road, Douglas, ISLE OF MAN
[740/ 註冊申請人的送達地址:	Hutchison Whampoa Agents Limited
750] Applicant's Address for Service:	48th Floor, Cheung Kong Center, 2 Queen's Road Central HONG KONG
[511] 類別編號:	9, 35, 38, 42, 45
Class(es) No(s) .:	
[511] 貨品 / 服務說明:	Class 42:
Specification:	Monitoring of network systems (for others); computer network services; computer network configuration services; development of

computer networks; computer software development and implementation; computer software programming; rental and leasing of computer software and hardware; consultancy in the fields of telecommunications technology and computing networks; integration of computer systems and networks; computer software and information technology technical support services; support and maintenance services for computer software; hosting of web sites of others; computer services, namely, computer support services, computer diagnostic services, computer network configuration services, computer system integration services, computer system monitoring services, computer network services, troubleshooting for computer networks, computer security services; cloud hosting provider services; computer services provided online from the internet; all the aforesaid services relating to the operation of telecommunications networks; none of the aforesaid services in relation to business information, business training, business networking, professional development courses, professional development events and setting standards for corporate governance.

- [526] 卸棄 : N/A
Disclaimer:
- [529] 限制 : N/A
Limitation:
- [527] 條件 : N/A
Condition:
其他 : N/A
Others
- [220] 提交日期 : 26-05-2021
Date of Filing:
- [320] 聲稱具有優先權的日期 : 04-05-2021
Date of Priority Claimed:
- [310] 優先權申請編號 : UK00003636391
Priority Application Number:
- [340] 聲稱具有優先權 (部分) : N/A
Priority Claim Details:
- [330] 優先權申請的
國家、地區、地方 : UNITED KINGDOM
Country, territory, area of
Priority Applications:
-
-

- [210] 商標申請編號 : 305652739
Application No.:

[540] 商標：
Mark:

MEETSOCIAL

[550] 商標種類： 一般商標
Mark Type:
一系列商標： 否
Series Mark:

[571] 商標描述： 不適用
Mark Description:

[730] 註冊申請人的姓名 / 名稱、地址： 飛書深諾數字科技（上海）股份有限公司
Applicant (s) ' 中國
Name, Address: 上海市普陀區
中江路 879 弄 28 號樓 4036 室

[740/ 註冊申請人的送達地址： 柯伍陳律師事務所
750] Applicant's Address for 香港
Service: 中環康樂廣場 8 號
交易廣場第三期 19 樓

[511] 類別編號： 9, 35, 36, 38, 41, 42, 45
Class(es) No(s) .:

[511] 貨品 / 服務說明： 類別 42：
Specification: 替他人研究和開發新產品；計算機軟件設計；計算機軟件更新
；把有形的數據或文件轉換成電子媒體；提供互聯網搜索引擎
；軟件即服務（SaaS）；雲計算；平台即服務（PaaS）；計
算機平台的開發；工業分析與研究。

[526] 卸棄： 不適用
Disclaimer:

[529] 限制： 不適用
Limitation:

[527] 條件： 不適用
Condition:
其他： 不適用
Others

[220] 提交日期： 09-06-2021
Date of Filing:

[320] 聲稱具有優先權的日期： 不適用
Date of Priority Claimed:

[310] 優先權申請編號： 不適用
Priority Application Number:

[340] 聲稱具有優先權（部分）： 不適用
Priority Claim Details:

[330] 優先權申請的 不適用
國家、地區、地方：
Country, territory, area of
Priority Applications:

[210] 商標申請編號 : 305654007

Application No.:

[540] 商標 :

Mark:



[550] 商標種類 : 一般商標

Mark Type:

一系列商標 :

否

Series Mark:

[571] 商標描述 : 不適用

Mark Description:

[730] 註冊申請人的姓名/名稱、地址 :

億率動力有限責任公司

Applicant (s) ' Name, Address:

加拿大

安大略省多倫多市

科德科街 9 號

[740/ 註冊申請人的送達地址 :

柯伍陳律師事務所

750] Applicant's Address for

香港

Service:

中環康樂廣場 8 號

交易廣場第三期 19 樓

9, 12, 42

[511] 類別編號 :

Class(es) No(s) .:

[511] 貨品/服務說明 :

Specification:

類別 42:

計算機軟件設計；計算機軟件研究和開發；計算機軟件的更新和維護；計算機軟件維護和升級；技術研究；替他人研究和開發新產品；科學實驗室服務；機器功能測試；產品測試；平台即服務（PaaS）；計算機平台的開發；手機應用軟件的設計和開發；人工智能領域的研究；軟件運營服務（SaaS）；為他人設計和開發計算機軟件；軟件即服務（SaaS）。

[526] 卸棄 :

Disclaimer:

不適用

[529] 限制 :

Limitation:

不適用

[527] 條件 :

Condition:

不適用

其他 :

不適用

Others

[220] 提交日期 :

11-06-2021

Date of Filing:

[320]

[310]

[340]

[330]

聲稱具有優先權的日期： Date of Priority Claimed:	優先權申請編號： Priority Application No.:	聲稱具有優先權 (部分)： Priority Claim Details:	優先權申請的 國家、地區、地方： Country, territory, area of Priority Applications:
---	--	---	---

07-02-2021	53650494	適用於類別 9	中國
------------	----------	---------	----

07-02-2021	53627406	適用於類別 12	中國
------------	----------	----------	----

07-02-2021	53650575	適用於類別 42	中國
------------	----------	----------	----

[210] 商標申請編號： 305654016
Application No.:

[540] 商標：
Mark:

ELEAPPOWER

[550] 商標種類： Ordinary
Mark Type:

一系列商標： NO
Series Mark:

[571] 商標描述： N/A
Mark Description:

[730] 註冊申請人的姓名 / 名稱、地址： ELEAPPOWER LTD. (億率動力有限責任公司)
Applicant(s) ' 9 Codeco Court,
Name, Address: Toronto, ONTARIO, Canada, M3A 1A1
CANADA

[740/ 註冊申請人的送達地址： ONC LAWYERS
750] Applicant's Address for 19TH FLOOR, THREE EXCHANGE SQUARE,
Service: 8 CONNAUGHT PLACE, CENTRAL,
HONG KONG

[511] 類別編號： 9, 12, 42
Class(es) No(s) .:

[511] 貨品 / 服務說明： Class 42:
Specification: Computer software design in the fields of
controlling the storage and discharge of
stored electricity for the operation of
electric vehicles, management of battery and
energy usage, monitoring and management of
vehicle operation and fleet operations and
management and analysis of data relating to
battery and energy usage; computer software
research and development in the fields of
controlling the storage and discharge of
stored electricity for the operation of

electric vehicles, management of battery and energy usage, monitoring and management of vehicle operation and fleet operations and management and analysis of data relating to battery and energy usage; update and maintenance of computer software in the fields of controlling the storage and discharge of stored electricity for the operation of electric vehicles, management of battery and energy usage, monitoring and management of vehicle operation and fleet operations and management and analysis of data relating to battery and energy usage; upgrading and maintenance of computer software in the fields of controlling the storage and discharge of stored electricity for the operation of electric vehicles, management of battery and energy usage, monitoring and management of vehicle operation and fleet operations and management and analysis of data relating to battery and energy usage; technological research in the fields of stored electricity and the operation of electric vehicles; research and development of new products for others in the fields of stored electricity and the operation of electric vehicles; scientific laboratory services in the fields of stored electricity and the operation of electric vehicles; machine function testing in the fields of stored electricity and the operation of electric vehicles; product testing in the fields of stored electricity and the operation of electric vehicles; software as a service [SaaS] featuring software for consolidating and analyzing data regarding the storage and discharge of stored electricity for the operation of electric vehicles, management of battery and energy usage, monitoring and management of vehicle operation and fleet operations and for management and analysis of data relating to battery and energy usage; platform as a service [PaaS] featuring computer software platforms for consolidating and analyzing data regarding the storage and discharge of stored electricity for the operation of electric vehicles, management of battery and energy usage, monitoring and management of vehicle operation and fleet operations and for management and analysis of data relating to battery and energy usage; development of computer platforms in the fields of stored electricity and the operation of electric vehicles, management of battery and energy usage, monitoring and management of vehicle operation and fleet operations and management and analysis of data relating to

battery and energy usage; Design and development of application software for mobile phones for the purposes of controlling the storage and discharge of stored electricity for the operation of electric vehicles, management of battery and energy usage, monitoring and management of vehicle operation and fleet operations and for management and analysis of data relating to battery and energy usage; research in the field of Artificial Intelligence; software operating service featuring software for consolidating and analyzing data regarding the storage and discharge of stored electricity for the operation of electric vehicles, management of battery and energy usage, monitoring and management of vehicle operation and fleet operations and management and analysis of data relating to battery and energy usage; design and development of computer software for others in the fields of stored electricity and the operation of electric vehicles, management of battery and energy usage, monitoring and management of vehicle operation and fleet operations and management and analysis of data relating to battery and energy usage.

- [526] 卸棄 : N/A
Disclaimer:
- [529] 限制 : N/A
Limitation:
- [527] 條件 : N/A
Condition:
其他 : N/A
Others
- [220] 提交日期 : 11-06-2021
Date of Filing:
- [320] 聲稱具有優先權的日期 : 23-12-2020
Date of Priority Claimed:
- [310] 優先權申請編號 : 2073532
Priority Application Number:
- [340] 聲稱具有優先權 (部分) : N/A
Priority Claim Details:
- [330] 優先權申請的
國家、地區、地方 : CANADA
Country, territory, area of
Priority Applications:
-
-

- [210] 商標申請編號 : 305679226
Application No.:

[540] 商標 :
Mark:

SPYBIOTECH

[550] 商標種類 : Ordinary
Mark Type:
一系列商標 : NO
Series Mark:

[571] 商標描述 : N/A
Mark Description:

[730] 註冊申請人的姓名 / 名稱、地址 : SPYBIOTECH LIMITED
Applicant(s) ' 7600 THE QUORUM, ALEC ISSIGONIS WAY,
Name,Address: OXFORD BUSINESS PARK NORTH, OXFORD, OX4 2JZ
UNITED KINGDOM

[740/ 註冊申請人的送達地址 : CHINAHONGKONG IP LIMITED
750] Applicant's Address for 1502, 15/F, Capital Centre,
Service: 151 Gloucester Road, Wanchai,
Hong Kong

[511] 類別編號 : 1,5,42
Class(es) No(s) .:

[511] 貨品 / 服務說明 : Class 42:
Specification: Medical and pharmaceutical research services;
biological research; development of
pharmaceutical preparations and medicines;
research and development relating to biologics
and vaccines; providing medical and scientific
research information in the field of
pharmaceuticals and vaccines; clinical trials;
clinical trial design for vaccines; scientific
services relating to the discovery,
preclinical and clinical development of
vaccines and therapeutic products; research
and development of new products for others;
development of pharmaceutical products for
others; information, advisory and consultancy
services relating to the aforesaid.

[526] 卸棄 : N/A
Disclaimer:

[529] 限制 : N/A
Limitation:

[527] 條件 : N/A
Condition:
其他 : N/A
Others

[220] 提交日期 : 07-07-2021
Date of Filing:

[320] 聲稱具有優先權的日期 : 26-03-2021
Date of Priority Claimed:

[310] 優先權申請編號 : UK00003617080
Priority Application Number:

[340] 聲稱具有優先權 (部分) : N/A
Priority Claim Details:

[330] 優先權申請的 UNITED KINGDOM
國家、地區、地方：
Country, territory, area of
Priority Applications:

[210] 商標申請編號： 305699468
Application No.:

[540] 商標： AMPLIFY BY NEXANS
Mark:

[550] 商標種類： Ordinary
Mark Type:
一系列商標： NO
Series Mark:

[571] 商標描述： N/A
Mark Description:

[730] 註冊申請人的姓名 / 名稱、地址： NEXANS
Applicant(s) ' 4 ALLÉE DE L'ARCHE,
Name,Address: 92400 COURBEVOIE,
FRANCE

[740/ 註冊申請人的送達地址： WILKINSON & GRIST
750] Applicant's Address for 6th Floor, Prince's Building
Service: Chater Road, Central
HONG KONG

[511] 類別編號： 9, 35, 37, 39, 42
Class(es) No(s).:

[511] 貨品 / 服務說明： Class 42:
Specification: Engineering services in the field of
infrastructures for the production,
transmission and distribution of electric
power, and in the field of electric and
communication networks, engineering and
research services in the field of
infrastructures for the production of
electricity and for networks for the
transmission and distribution of electric
power and communication networks and their
components; quality control services for
electric and communication networks and their
components; engineering services for analysis
and evaluation of the efficiency of electrical
networks and installations and their
components and of communication networks;
engineering services for the technical
monitoring of infrastructures and networks for
the transport and distribution of electrical
energy and of communication networks and their
components; design of software for the

management of electrical networks and of recharging points and terminals for electrical energy for vehicles; on-line provision of non-downloadable computer programs for decision support in the field of infrastructures for the transport and distribution of electrical energy, electrical or communication networks and their components; management of technical projects in the field of electrical and communication networks; technical research services in the field of recycling of electrical materials and electrical and communication cables and the provision of related technical advice; technical assistance services for obtaining certifications and approvals; technical advice [engineering services] for the verification of the conformity of electrical installations, electrical and communication networks; software design for the implementation of electrical and communication networks, their maintenance, monitoring, cost calculation; engineering and scientific research services in the field of energy saving; engineering and technical and scientific research services in the field of sustainable development, energy transition, recycling of electrical and communication materials.

[526] 卸棄 : N/A
Disclaimer:

[529] 限制 : N/A
Limitation:

[527] 條件 : N/A
Condition:
其他 : N/A
Others

[220] 提交日期 : 27-07-2021
Date of Filing:

[320] 聲稱具有優先權的日期 : 09-02-2021
Date of Priority Claimed:

[310] 優先權申請編號 : 4730981
Priority Application Number:

[340] 聲稱具有優先權 (部分) : N/A
Priority Claim Details:

[330] 優先權申請的
國家、地區、地方 : FRANCE
Country, territory, area of
Priority Applications:

- [210] 商標申請編號 : 305733171
Application No.:
- [540] 商標 :
Mark:
- 
- [550] 商標種類 : Ordinary
Mark Type:
一系列商標 : NO
Series Mark:
- [571] 商標描述 : N/A
Mark Description:
- [730] 註冊申請人的姓名 / 名稱、地址 : Aston Martin Lagonda Limited
Applicant (s) ' Banbury Road, Gaydon,
Name,Address: Warwick CV35 0DB
UNITED KINGDOM
- [740/ 註冊申請人的送達地址 : SIMONE INTELLECTUAL PROPERTY SERVICES ASIA
750] Applicant's Address for LIMITED
Service: 25th Floor, 3 Lockhart Road,
Wanchai,
HONG KONG
- [511] 類別編號 : 3, 6, 7, 8, 9, 12, 14, 16, 18, 20, 21, 24, 25, 27, 28, 33, 34,
Class(es) No(s) : 35, 36, 37, 39, 40, 41, 42, 43
- [511] 貨品 / 服務說明 : Class 42:
Specification: Design services; interior design; styling services; industrial design; interior decorator services; architecture; architectural research, consultancy, consultation, planning, project management; engineering services; urban planning services; preparation of architectural reports and architectural plans; technical design services relating to buildings, machinery, vehicles; design services for prevention of flooding; quality control relating to buildings, building materials, machinery, vehicles; monitoring of building structures; analysis of building environments; city planning; urban design and planning; digital imaging (processing, compression, storage, display, digitalization and scanning of images); safety testing services; design services for business, commercial, industrial, residential or retail premises; exterior design services; product and packaging design services; furniture design; design of furnishings and interior décor; apps and software development services; prototypes and roll-out design services; advisory services relating to interior design of business, commercial, industrial or retail premises; consultancy relating to selection of furnishings and decor; design, styling and planning of joinery and parts and fittings used in building and

construction of business, commercial, industrial or retail premises or exhibition stands; consultancy, design and advice and information services relating to brands, brand identity and brand development; design of boats and seagoing vessels; design of electronics; design of home entertainment systems, rooms for home entertainment, audio systems, video systems, computer systems, home storage; Design of land vehicles; design of yachts, boats and ships; design of land vehicle parts; design of vehicles and vehicle parts, fittings, accessories and components; testing of vehicles; safety technology services relating to land vehicles; product development for vehicle construction and for vehicle body construction; development of vehicles; automotive design; advisory services relating to design engineering; engineering consultancy; graphic design; architectural design; packaging design; commercial art design; computer software design; design of interior décor; design of mechanical and micromechanical components; design and development of computer game software; design and development of virtual reality software, simulator software, artificial intelligence software; design and testing for new product development; furnishing design services for the interiors of automobiles; room design consisting of selection of artwork, lighting, and furnishings for an environment designed to help achieve mental wellness, including stress management and relaxation, using computer controlled advanced sound wave technology; furnishing design services; design of hotels; house design services; research and exploitation of works of engineering, works of architecture, works of robotics, works of artificial intelligence, works of machinery; geological surveys; chemical research; biology research; meteorological information; technical testing services; design of racing venues, sporting venues, race tracks; construction consulting and designing; dressing designing; computer programming and related service; software as service services and platform as service services; provision of online non-downloadable software; technical inspection service, in particular rating the condition of pre-owned cars for buyers prior to purchase to verify that pre-owned cars have been reconditioned and are in good working order; technical inspection services in relation to the inspection and conditioning of vehicles providing a rating prior to third

party purchase; provision of information, advisory and consultancy services relating to the aforesaid services.

- [526] 卸棄: N/A
Disclaimer:
- [529] 限制: N/A
Limitation:
- [527] 條件: N/A
Condition:
其他: N/A
Others
- [220] 提交日期: 31-08-2021
Date of Filing:
- [320] 聲稱具有優先權的日期: 01-03-2021
Date of Priority Claimed:
- [310] 優先權申請編號: 82787
Priority Application Number:
- [340] 聲稱具有優先權 (部分): for goods listed in "A" in Classes 9 and 12
Priority Claim Details: and for all goods and services in Classes 3, 6, 7, 8, 14, 16, 18, 20, 21, 24, 25, 27, 28, 33, 34, 35, 36, 37, 39, 40, 41, 42 and 43
- [330] 優先權申請的
國家、地區、地方: JAMAICA
Country, territory, area of
Priority Applications:

- [210] 商標申請編號: 305733180
Application No.:

- [540] 商標:
Mark:



- [550] 商標種類: Ordinary
Mark Type:
一系列商標: NO
Series Mark:
- [571] 商標描述: N/A
Mark Description:
- [730] 註冊申請人的姓名 / 名稱、地址: Aston Martin Lagonda Limited
Applicant(s) ' Banbury Road, Gaydon,
Name, Address: Warwick CV35 0DB
UNITED KINGDOM
- [740/ 註冊申請人的送達地址: SIMONE INTELLECTUAL PROPERTY SERVICES ASIA
750] Applicant's Address for LIMITED
Service: 25th Floor, 3 Lockhart Road,
Wanchai,
HONG KONG

[511] 類別編號 : 3, 6, 7, 8, 9, 12, 14, 16, 18, 20, 21, 24, 25, 27, 28, 33, 34,
Class(es) No(s) : 35, 36, 37, 39, 40, 41, 42, 43

[511] 貨品 / 服務說明 :
Specification: Class 42:
Design services; interior design; styling services; industrial design; interior decorator services; architecture; architectural research, consultancy, consultation, planning, project management; engineering services; urban planning services; preparation of architectural reports and architectural plans; technical design services relating to buildings, machinery, vehicles; design services for prevention of flooding; quality control relating to buildings, building materials, machinery, vehicles; monitoring of building structures; analysis of building environments; city planning; urban design and planning; digital imaging (processing, compression, storage, display, digitalization and scanning of images); safety testing services; design services for business, commercial, industrial, residential or retail premises; exterior design services; product and packaging design services; furniture design; design of furnishings and interior décor; apps and software development services; prototypes and roll-out design services; advisory services relating to interior design of business, commercial, industrial or retail premises; consultancy relating to selection of furnishings and decor; design, styling and planning of joinery and parts and fittings used in building and construction of business, commercial, industrial or retail premises or exhibition stands; consultancy, design and advice and information services relating to brands, brand identity and brand development; design of boats and seagoing vessels; design of electronics; design of home entertainment systems, rooms for home entertainment, audio systems, video systems, computer systems, home storage; Design of land vehicles; design of yachts, boats and ships; design of land vehicle parts; design of vehicles and vehicle parts, fittings, accessories and components; testing of vehicles; safety technology services relating to land vehicles; product development for vehicle construction and for vehicle body construction; development of vehicles; automotive design; advisory services relating to design engineering; engineering consultancy; graphic design; architectural design; packaging design; commercial art design; computer software design; design of interior décor; design of mechanical and

micromechanical components; design and development of computer game software; design and development of virtual reality software, simulator software, artificial intelligence software; design and testing for new product development; furnishing design services for the interiors of automobiles; room design consisting of selection of artwork, lighting, and furnishings for an environment designed to help achieve mental wellness, including stress management and relaxation, using computer controlled advanced sound wave technology; furnishing design services; design of hotels; house design services; research and exploitation of works of engineering, works of architecture, works of robotics, works of artificial intelligence, works of machinery; geological surveys; chemical research; biology research; meteorological information; technical testing services; design of racing venues, sporting venues, race tracks; construction consulting and designing; dressing designing; computer programming and related service; software as service services and platform as service services; provision of online non-downloadable software; technical inspection service, in particular rating the condition of pre-owned cars for buyers prior to purchase to verify that pre-owned cars have been reconditioned and are in good working order; technical inspection services in relation to the inspection and conditioning of vehicles providing a rating prior to third party purchase; provision of information, advisory and consultancy services relating to the aforesaid services.

- [526] 卸棄 : N/A
Disclaimer:
- [529] 限制 : N/A
Limitation:
- [527] 條件 : N/A
Condition:
其他 : N/A
Others
- [220] 提交日期 : 31-08-2021
Date of Filing:
- [320] 聲稱具有優先權的日期 : 01-03-2021
Date of Priority Claimed:
- [310] 優先權申請編號 : 82788
Priority Application Number:
- [340] 聲稱具有優先權 (部分) : for goods listed in "A" in Classes 9 and 12
Priority Claim Details: and for all goods and services in Classes 3, 6, 7, 8, 14, 16, 18, 20, 21, 24, 25, 27, 28, 33, 34, 35, 36, 37, 39, 40, 41, 42 and 43
- [330] 優先權申請的 JAMAICA

國家、地區、地方：

Country, territory, area of
Priority Applications:

[210]	商標申請編號： Application No.:	305739922
[540]	商標： Mark:	
[550]	商標種類： Mark Type:	Ordinary
	一系列商標： Series Mark:	NO
[571]	商標描述： Mark Description:	N/A
[730]	註冊申請人的姓名 / 名稱、地址： Applicant(s)' Name, Address:	Steinel GmbH Dieselstraße 80-84 33442 Herzebrock-Clarholz GERMANY
[740/ 750]	註冊申請人的送達地址： Applicant's Address for Service:	SFKS CK Kwong, Solicitors 17th Floor, Chu Kong Shipping Tower, No. 143 Connaught Road Central, Hong Kong
[511]	類別編號： Class(es) No(s) .:	1, 7, 8, 9, 11, 42
[511]	貨品 / 服務說明： Specification:	Class 42: Scientific and technological services and research services and related design services; technical design and technical project planning of electronic systems for lighting, alarm and home automation; scientific and industrial research and development in the field of sensor and lighting technology and electrical and electronic heat, tool and measurement technology; development, programming and implementation of software.
[526]	卸棄： Disclaimer:	N/A
[529]	限制： Limitation:	N/A
[527]	條件： Condition:	N/A
	其他： Others	N/A
[220]	提交日期： Date of Filing:	08-09-2021
[320]	聲稱具有優先權的日期：	N/A

Date of Priority Claimed:

[310] 優先權申請編號: N/A

Priority Application Number:

[340] 聲稱具有優先權 (部分): N/A

Priority Claim Details:

[330] 優先權申請的 N/A

國家、地區、地方:

Country, territory, area of

Priority Applications:

[210] 商標申請編號: 305751586

Application No.:

[540] 商標:

Mark:



majUP

[550] 商標種類: Ordinary

Mark Type:

一系列商標: NO

Series Mark:

[571] 商標描述: The applicant claims the colours blue, white and turquoise as elements of the trade mark.

Mark Description:

[730] 註冊申請人的姓名 / 名稱、地址: Majorel Berlin GmbH

Applicant(s)'

Name, Address:

Wohlrabedamm 32

13629 Berlin

GERMANY

[740/ 註冊申請人的送達地址:

DEACONS

750] Applicant's Address for Service:

5th Floor,

Alexandra House Central

HONG KONG

[511] 類別編號: 9, 35, 36, 38, 39, 41, 42, 43, 45

Class(es) No(s) .:

[511] 貨品 / 服務說明: Class 42:

Specification:

Scientific and technological services and research and related design services; industrial analysis and research services; scientific sectoral analysis; Design and development of computers, computer software

and applications for mobile telephones; Infographic design; Engineering and scientific services, including technical consultancy services; Computer system analysis; Technical advice on an outsourcing basis; Technical consultancy on an outsourcing basis, in particular in relation to computer equipment, multimedia and telephony products; Handwriting analyzes [graphology]; Data encryption services; Design services of a graphic designer; Computer graphic design; Graphic design; Computer systems design; Implementation of technical project planning; Consultancy in the field of computer design and development; Consultancy in the field of internet security; Consultancy in the field of data security; Advice on the design of websites; Consultancy in the field of information technology [IT]; Technological advisory services; Consultancy in the field of computer technology; Consultancy in the field of telecommunications technology; Computer software consultancy; Computer security advice; Quality inspection; Checking [inspection] of vehicles for road safety; Conversion of data or documents from physical to electronic media; Creation and maintenance of websites for others; Creation and design of website-based information directories for others [information technology services]; Unlocking of mobile phones; Preparation of technical drawings; Packaging design services; Software development within the framework of software publishing; Duplication of computer programs; Preparation of technical expert opinion; Outsourced services in the field of information technology; Hosting websites; Server hosting; Providing information on computer technology and programming via a website; Engineering services; Installation of computer programs; Software as a Service [SaaS]; Computer software rental services; Maintenance of computer software; Updating of computer software; Digitization of documents [scanning]; Rental of data processing equipment; Platform as a Service [PaaS]; Creating programs for data processing; Computer virus protection services; Research and development services for new products for others; Research in the field of technology; Scientific Research; Recovery of computer data; Technical writing; External data backup; Rental of web servers; Electronic data storage; Monitoring of computer systems to detect breakdowns; Monitoring of computer systems for the detection of unauthorized

access and data protection violations;
Electronic monitoring of personal data for
identity theft detection via the Internet;
Electronic monitoring of credit card
transactions to detect fraud over the
internet; Remote monitoring of computer
systems.

[526] 卸棄 : N/A
Disclaimer:
[529] 限制 : N/A
Limitation:
[527] 條件 : N/A
Condition:
其他 : N/A
Others
[220] 提交日期 : 20-09-2021
Date of Filing:
[320] 聲稱具有優先權的日期 : 19-03-2021
Date of Priority Claimed:
[310] 優先權申請編號 : 302021006047
Priority Application Number:
[340] 聲稱具有優先權 (部分) : N/A
Priority Claim Details:
[330] 優先權申請的 GERMANY
國家、地區、地方 :
Country, territory, area of
Priority Applications:

[210] 商標申請編號 : 305760225
Application No.:

[540] 商標 :
Mark:

NITREAT

[550] 商標種類 : Ordinary
Mark Type:
一系列商標 : NO
Series Mark:

[571] 商標描述 : N/A
Mark Description:

[730] 註冊申請人的姓名 / 名稱、地址 : NITTO DENKO CORPORATION
Applicant(s) ' 1-2, Shimohozumi 1-chome,
Name,Address: Ibaraki-shi, Osaka 567-8680
JAPAN

[740/ 註冊申請人的送達地址 : MARKS & CLERK
750] Applicant's Address for Level 9, Cyberport 1
Service:

100 Cyberport Road, Pok Fu Lam
HONG KONG

[511] 類別編號: 3,5,8,9,10,11,16,17,18,21,24,25,28,42
Class(es) No(s) .:

[511] 貨品 / 服務說明:
Specification:
Class 42:
Scientific and technological services and research and design related thereto; industrial analysis, industrial research and industrial design services; quality control and authentication services; design and development of computer hardware and software; designing of machines, apparatus, instruments [including their parts] or systems composed of such machines, apparatus and instruments; designing of water treatment equipment (hardware design); designing of electric wires (hardware design); designing, other than for advertising purposes; computer software design; computer programming; maintenance of computer software; computer system design; software as a service [SaaS]; platform as a service [PaaS]; cloud computing; electronic data storage; technological advice relating to computers, automobiles and industrial machines; testing, inspection or research of pharmaceuticals, cosmetics or foodstuffs; testing, inspection or research of cells and tissue cultures; research, development, testing and inspection in the field of manufacturing and applications of plastics; research, development, testing and inspection in the field of water treatment; water analysis; water quality control services; monitoring of water quality; underwater exploration; marine, aerial and land surveying; analysis, control and monitoring of air quality; chemical analysis; quality control; styling[industrial design]; testing, calibration and inspection of filters; environmental monitoring services; research and development of new products for others; research on building construction or city planning; testing or research on prevention of pollution; testing or research on electricity; testing or research on civil engineering; environmental analysis and research; material inspection and evaluation by analytical instruments and physical property evaluation; testing, inspection and research services in the fields of agriculture, livestock breeding and fisheries; testing or research on machines, apparatus and instruments; rental of measuring apparatus; rental of computers; providing computer programs on data networks; rental of laboratory apparatus and

instruments; rental of technical drawing instruments; research, development, testing and inspection in the field of kinesiology.

- [526] 卸棄 : N/A
Disclaimer:
- [529] 限制 : N/A
Limitation:
- [527] 條件 : N/A
Condition:
其他 : N/A
Others
- [220] 提交日期 : 29-09-2021
Date of Filing:
- [320] 聲稱具有優先權的日期 : N/A
Date of Priority Claimed:
- [310] 優先權申請編號 : N/A
Priority Application Number:
- [340] 聲稱具有優先權 (部分) : N/A
Priority Claim Details:
- [330] 優先權申請的
國家、地區、地方 : N/A
Country, territory, area of
Priority Applications:

- [210] 商標申請編號 : 305767958
Application No.:

- [540] 商標 :
Mark:

SHAREPLAY

- [550] 商標種類 : Ordinary
Mark Type:
一系列商標 : NO
Series Mark:

- [571] 商標描述 : N/A
Mark Description:

- [730] 註冊申請人的姓名 / 名稱、地址 : APPLE INC.
Applicant(s) ' ONE APPLE PARK WAY,
Name, Address: CUPERTINO, CALIFORNIA 95014,
UNITED STATES OF AMERICA

- [740/ 註冊申請人的送達地址 : BAKER & MCKENZIE
750] Applicant's Address for 14TH FLOOR, ONE TAIKOO PLACE,
Service: 979 KING'S ROAD, QUARRY BAY,
HONG KONG

- [511] 類別編號 : 9, 35, 38, 41, 42
Class(es) No(s) .:

- [511] 貨品 / 服務說明 :
Specification:
- Class 42:
Design and development of computer hardware, software, peripherals, and computer and video games; computer hardware and software consulting services; computer programming; design of computer databases; electronic data storage; cloud computing services; rental of computer hardware, software, and peripherals; providing online non-downloadable software; providing computer hardware or software information online; technical support services, diagnosing and troubleshooting of computer software problems, and computer help desk services; website creation, design, and maintenance services; website hosting services; providing search engines for obtaining data via the internet and other electronic communications networks; creating indexes of online information, sites and other resources available on the Internet and other electronic communications networks; providing an Internet portal allowing users to preview and download electronic books, publications, and other documents; information, advisory and consultancy services relating to all the aforesaid.
- [526] 卸棄 :
Disclaimer: N/A
- [529] 限制 :
Limitation: N/A
- [527] 條件 :
Condition: N/A
其他 :
Others: N/A
- [220] 提交日期 :
Date of Filing: 08-10-2021
- [320] 聲稱具有優先權的日期 :
Date of Priority Claimed: 09-04-2021
- [310] 優先權申請編號 :
Priority Application Number: 2021-319
- [340] 聲稱具有優先權 (部分) :
Priority Claim Details: N/A
- [330] 優先權申請的
國家、地區、地方 :
Country, territory, area of
Priority Applications: LIECHTENSTEIN
-
- [210] 商標申請編號 :
Application No.: 305767967

[540] 商標 :
Mark:

XCODE CLOUD

[550] 商標種類 : Ordinary

Mark Type:

一系列商標 :

NO

Series Mark:

[571] 商標描述 : N/A

Mark Description:

[730] 註冊申請人的姓名 / 名稱、地址 :

APPLE INC.

Applicant(s)'

ONE APPLE PARK WAY,

Name,Address:

CUPERTINO, CALIFORNIA 95014,

UNITED STATES OF AMERICA

[740/ 註冊申請人的送達地址 :

BAKER & MCKENZIE

750] Applicant's Address for

Service:

14TH FLOOR, ONE TAIKOO PLACE,

979 KING'S ROAD, QUARRY BAY,

HONG KONG

[511] 類別編號 : 42

Class(es) No(s) .:

[511] 貨品 / 服務說明 : Class 42:

Specification:

Design and development of computer hardware, software, peripherals, and computer and video games; computer hardware and software consulting services; computer programming; design of computer databases; electronic data storage; cloud computing services; rental of computer hardware, software, and peripherals; providing online non-downloadable software; consultation services for developing computer systems, databases and applications; computer security and data security consultancy; data encryption services; providing computer hardware or software information online; maintenance, repair and updating of computer software and applications; technical support services, diagnosing and troubleshooting of computer hardware and software problems, and computer help desk services; website creation, design, and maintenance services; website hosting services; providing search engines for obtaining data via the internet and other electronic communications networks; creating indexes of online information, sites and other resources available on the Internet and other electronic communications networks; cartography and mapping services; providing an Internet portal allowing users to preview and download electronic books, publications, and other documents; scientific and technological services; industrial design services; industrial analysis and research services; medical research; medical laboratories;

information, advisory and consultancy services relating to all the aforesaid.

[526] 卸棄: N/A
Disclaimer:
[529] 限制: N/A
Limitation:
[527] 條件: N/A
Condition:
其他: N/A
Others
[220] 提交日期: 08-10-2021
Date of Filing:
[320] 聲稱具有優先權的日期: 09-04-2021
Date of Priority Claimed:
[310] 優先權申請編號: 2021-321
Priority Application Number:
[340] 聲稱具有優先權 (部分): N/A
Priority Claim Details:
[330] 優先權申請的
國家、地區、地方: LIECHTENSTEIN
Country, territory, area of
Priority Applications:

[210] 商標申請編號: 305767976
Application No.:

[540] 商標:
Mark:

MEMORY MIXES

[550] 商標種類: Ordinary
Mark Type:
一系列商標: NO
Series Mark:

[571] 商標描述: N/A
Mark Description:

[730] 註冊申請人的姓名 / 名稱、地址: APPLE INC.
Applicant(s) ' ONE APPLE PARK WAY,
Name,Address: CUPERTINO, CALIFORNIA 95014,
UNITED STATES OF AMERICA

[740/ 註冊申請人的送達地址: BAKER & MCKENZIE
750] Applicant's Address for 14TH FLOOR, ONE TAIKOO PLACE,
Service: 979 KING'S ROAD, QUARRY BAY,
HONG KONG

[511] 類別編號: 9, 42
Class(es) No(s) .:

- [511] 貨品 / 服務說明 :
Specification:
- Class 42:
Design and development of computer hardware, software, peripherals, and computer and video games; computer hardware and software consulting services; computer programming; design of computer databases; electronic data storage; cloud computing services; rental of computer hardware, software, and peripherals; providing online non-downloadable software; consultation services for developing computer systems, databases and applications; computer security and data security consultancy; data encryption services; providing computer hardware or software information online; maintenance, repair and updating of computer software and applications; technical support services, diagnosing and troubleshooting of computer hardware and software problems, and computer help desk services; website creation, design, and maintenance services; website hosting services; providing search engines for obtaining data via the internet and other electronic communications networks; creating indexes of online information, sites and other resources available on the Internet and other electronic communications networks; cartography and mapping services; providing an Internet portal allowing users to preview and download electronic books, publications, and other documents; scientific and technological services; industrial design services; industrial analysis and research services; medical research; medical laboratories; information, advisory and consultancy services relating to all the aforesaid.
- [526] 卸棄 :
Disclaimer: N/A
- [529] 限制 :
Limitation: N/A
- [527] 條件 :
Condition: N/A
其他 :
Others: N/A
- [220] 提交日期 :
Date of Filing: 08-10-2021
- [320] 聲稱具有優先權的日期 :
Date of Priority Claimed: 12-04-2021
- [310] 優先權申請編號 :
Priority Application Number: 2021-327
- [340] 聲稱具有優先權 (部分) :
Priority Claim Details: N/A
- [330] 優先權申請的
國家、地區、地方 :
LIECHTENSTEIN

Country, territory, area of
Priority Applications:

[210] 商標申請編號 : 305767985
Application No.:

[540] 商標 :
Mark:

MEMORY LOOKS

[550] 商標種類 : Ordinary
Mark Type:
一系列商標 : NO
Series Mark:

[571] 商標描述 : N/A
Mark Description:

[730] 註冊申請人的姓名 / 名稱、地址 : APPLE INC.
Applicant(s) ' ONE APPLE PARK WAY,
Name, Address: CUPERTINO, CALIFORNIA 95014,
UNITED STATES OF AMERICA

[740/ 註冊申請人的送達地址 : BAKER & MCKENZIE
750] Applicant's Address for 14TH FLOOR, ONE TAIKOO PLACE,
Service: 979 KING'S ROAD, QUARRY BAY,
HONG KONG

[511] 類別編號 : 9, 42
Class(es) No(s) .:

[511] 貨品 / 服務說明 : Class 42:
Specification: Design and development of computer hardware,
software, peripherals, and computer and video
games; computer hardware and software
consulting services; computer programming;
design of computer databases; electronic data
storage; cloud computing services; rental of
computer hardware, software, and peripherals;
providing online non-downloadable software;
consultation services for developing computer
systems, databases and applications; computer
security and data security consultancy; data
encryption services; providing computer
hardware or software information online;
maintenance, repair and updating of computer
software and applications; technical support
services, diagnosing and troubleshooting of
computer hardware and software problems, and
computer help desk services; website creation,
design, and maintenance services; website
hosting services; providing search engines for
obtaining data via the internet and other
electronic communications networks; creating
indexes of online information, sites and other
resources available on the Internet and other

electronic communications networks;
cartography and mapping services; providing an
Internet portal allowing users to preview and
download electronic books, publications, and
other documents; scientific and technological
services; industrial design services;
industrial analysis and research services;
medical research; medical laboratories;
information, advisory and consultancy services
relating to all the aforesaid.

- [526] 卸棄 : N/A
Disclaimer:
- [529] 限制 : N/A
Limitation:
- [527] 條件 : N/A
Condition:
其他 : N/A
Others
- [220] 提交日期 : 08-10-2021
Date of Filing:
- [320] 聲稱具有優先權的日期 : 12-04-2021
Date of Priority Claimed:
- [310] 優先權申請編號 : 2021-326
Priority Application Number:
- [340] 聲稱具有優先權 (部分) : N/A
Priority Claim Details:
- [330] 優先權申請的
國家、地區、地方 : LIECHTENSTEIN
Country, territory, area of
Priority Applications:

- [210] 商標申請編號 : 305774202
Application No.:

- [540] 商標 : A
Mark:



B



C



D



[550] 商標種類 :	Ordinary
Mark Type:	
一系列商標 :	YES
Series Mark:	
[571] 商標描述 :	N/A
Mark Description:	
[730] 註冊申請人的姓名 / 名稱、地址 :	The Artisan Development Limited
Applicant(s) ' Name,Address:	Vistra Corporate Services Centre, Wickhams Cay II, Road Town, Tortola, VG1110 VIRGIN ISLANDS (BRITISH)
[740/ 註冊申請人的送達地址 :	WOO KWAN LEE & LO
750] Applicant's Address for Service:	Room 2801, Sun Hung Kai Centre, 30 Harbour Road, Wanchai HONG KONG
[511] 類別編號 :	35,36,37,42
Class(es) No(s) .:	
[511] 貨品 / 服務說明 :	Class 42:
Specification:	architectural and design services in relation to real estate and property; architectural project management; engineering project management services; off site building project

management; land surveying; surveying; design of interior decor; interior design services; architectural services; all included in Class 42.

- [526] 卸棄 : N/A
Disclaimer:
- [529] 限制 : N/A
Limitation:
- [527] 條件 : N/A
Condition:
其他 : N/A
Others
- [220] 提交日期 : 18-10-2021
Date of Filing:
- [320] 聲稱具有優先權的日期 : N/A
Date of Priority Claimed:
- [310] 優先權申請編號 : N/A
Priority Application Number:
- [340] 聲稱具有優先權 (部分) : N/A
Priority Claim Details:
- [330] 優先權申請的
國家、地區、地方 : N/A
Country, territory, area of
Priority Applications:

-
- [210] 商標申請編號 : 305785282
Application No.:

- [540] 商標 :
Mark:

LACEWORK

- [550] 商標種類 : Ordinary
Mark Type:
一系列商標 : NO
Series Mark:

- [571] 商標描述 : N/A
Mark Description:



- [730] 註冊申請人的姓名 / 名稱、地址 : Lacework, Inc.
Applicant(s) ' 6201 America Center Dr #200
Name,Address: San Jose, CA 95002
UNITED STATES OF AMERICA

- [740/ 註冊申請人的送達地址 : ONC LAWYERS
750] Applicant's Address for 19TH FLOOR, THREE EXCHANGE SQUARE,
Service: 8 CONNAUGHT PLACE, CENTRAL,
HONG KONG

- [511] 類別編號 : 9, 35, 42
Class(es) No(s) .:

[511] 貨品 / 服務說明 : Specification:	Class 42: Software development consulting in the field of network security; Software development consulting in the field of cloud, mobile or network applications; Design, development and implementation of software in the field of network security; design, development and implementation of software in the fields of cloud, mobile or network applications; Design and development of electronic data security systems; Development of software for secure network operations; technical support, namely, monitoring technological functions of computer network systems; Software as a service (SAAS) services featuring software for use in computer network security and for monitoring and identifying computer network users and cloud, mobile or network applications and computer hardware and the network activities of computer users and cloud, mobile or network applications; technical support services, namely, troubleshooting in the nature of diagnosing computer hardware and software problems related to computer network security.
[526] 卸棄 : Disclaimer:	N/A
[529] 限制 : Limitation:	N/A
[527] 條件 : Condition: 其他 : Others	N/A N/A
[220] 提交日期 : Date of Filing:	28-10-2021
[320] 聲稱具有優先權的日期 : Date of Priority Claimed:	N/A
[310] 優先權申請編號 : Priority Application Number:	N/A
[340] 聲稱具有優先權 (部分) : Priority Claim Details:	N/A
[330] 優先權申請的 國家、地區、地方 : Country, territory, area of Priority Applications:	N/A

[210] 商標申請編號 : 305786182
Application No.:

- [540] 商標 :
Mark:
- A  IHKSPORTS
COACHING FOR
YOUTH ACADEMY
凝動教練培訓學院
- B  IHKSPORTS
COACHING FOR
YOUTH ACADEMY
凝動教練培訓學院
- [550] 商標種類 : Ordinary
Mark Type:
一系列商標 : YES
Series Mark:
- [571] 商標描述 : The applicant claims the colours blue and orange as elements of mark "A" in the series.
Mark Description:
- [730] 註冊申請人的姓名 / 名稱、地址 : INSPIRINGHK SPORTS FOUNDATION LIMITED (凝動香港體育基金有限公司)
Applicant(s) ' Name, Address: Unit 1801-02, Jubilee Centre, 46 Gloucester Road, Wanchai HONG KONG
- [740/ 註冊申請人的送達地址 : BIRD & BIRD
750] Applicant's Address for 6/F, The Annex, Central Plaza Service: 18 Harbour Road HONG KONG
- [511] 類別編號 : 36, 38, 41, 42
Class(es) No(s) .:
- [511] 貨品 / 服務說明 : Class 42:
Specification: Software as a service (Saas) relating to teaching support services namely scheduling, notifications and communication services; Platform as a Service (PaaS) featuring computer software platforms; Software as a Service (SaaS) relating to the provision of online education, game, or entertainment; Platform as a Service (PaaS) relating to the provision of online education, game, or entertainment; computer services relating to online calendars that allow multiple participants to share schedules, reservations and notifications; computer programming relating to the provision of online education, game, or entertainment.
- [526] 卸棄 : N/A
Disclaimer:
- [529] 限制 : N/A
Limitation:
- [527] 條件 : N/A
Condition:
其他 : N/A
Others
- [220] 提交日期 : 29-10-2021
Date of Filing:

[320]	聲稱具有優先權的日期: Date of Priority Claimed:	N/A
[310]	優先權申請編號: Priority Application Number:	N/A
[340]	聲稱具有優先權 (部分): Priority Claim Details:	N/A
[330]	優先權申請的 國家、地區、地方: Country, territory, area of Priority Applications:	N/A
[210]	商標申請編號: Application No.:	305786281
[540]	商標: Mark:	
[550]	商標種類: Mark Type:	Ordinary
	一系列商標: Series Mark:	NO
[571]	商標描述: Mark Description:	N/A
[730]	註冊申請人的姓名 / 名稱、地址: Applicant(s)' Name, Address:	Bygraphic Automation Limited Workstation25, Units 01-03 & 05-06, 25/F, CDW Building 388 Castle Peak Road, Tsuen Wan HONG KONG
[740/750]	註冊申請人的送達地址: Applicant's Address for Service:	Bygraphic Automation Limited Workstation25, Units 01-03 & 05-06, 25/F, CDW Building 388 Castle Peak Road, Tsuen Wan HONG KONG
[511]	類別編號: Class(es) No(s) .:	42
[511]	貨品 / 服務說明: Specification:	Class 42: Fashion Design; Bespoke shirt design; Bespoke shirt design services; Fashion design services; Customizing shirt design services;
[526]	卸棄: Disclaimer:	N/A

[529] 限制 : N/A
Limitation:

[527] 條件 : N/A
Condition:
其他 : N/A
Others

[220] 提交日期 : 29-10-2021
Date of Filing:

[320] 聲稱具有優先權的日期 : N/A
Date of Priority Claimed:

[310] 優先權申請編號 : N/A
Priority Application Number:

[340] 聲稱具有優先權 (部分) : N/A
Priority Claim Details:

[330] 優先權申請的
國家、地區、地方 : N/A
Country, territory, area of
Priority Applications:

[210] 商標申請編號 : 305786849
Application No.:

[540] 商標 : A
Mark:



B



- [550] 商標種類 : Ordinary
 Mark Type:
 一系列商標 : YES
 Series Mark:
- [571] 商標描述 : N/A
 Mark Description:
- [730] 註冊申請人的姓名 / 名稱、地址 : Advanced New Technologies Co., Ltd.
 Applicant(s) ' Cayman Corporate Centre, 27 Hospital Road,
 Name,Address: George Town, Grand Cayman KY1-9008,
 CAYMAN ISLANDS
- [740/ 註冊申請人的送達地址 : SIMMONS & SIMMONS
 750] Applicant's Address for 30th Floor, One Taikoo Place
 Service: 979 King's Road,
 HONG KONG
- [511] 類別編號 : 9, 35, 36, 42
 Class(es) No(s) .:
- [511] 貨品 / 服務說明 : Class 42:
 Specification: Scientific and technological services and
 research and design relating thereto,
 industrial analysis and research services;
 design and development of computer hardware
 and software; software as a service (SaaS);
 blockchain as a service (BaaS); encryption,
 decryption and authentication of information,
 messages and data; providing user
 authentication services using biometric,
 facial recognition, finger print
 authentication, voice recognition and other
 types of hardware and software authentication
 technology for provision of financial
 services, e-commerce transactions, donations,
 licensed product tracking and fan engagement;
 data security services; IT security,
 protection and restoration; computer security
 threat analysis for protecting data; provision
 of security services for computer networks,
 computer access and computerised transactions;
 certification (quality control) of data via
 blockchain; data authentication via

blockchain; including all of the aforementioned services for use in connection with payment systems; computer services in connection with transmitting information, data, documents, and images over the Internet; application service provider (ASP) services, namely, hosting computer software applications of others; application service provider (ASP) services providing software in the fields of web-based conferencing, audio conferencing, electronic messaging, document collaboration, video conferencing, and voice and call processing; providing online non-downloadable software for facilitating the interoperability of multiple software applications; technical support services relating to computer software and applications provided online, by email and by telephone; computer services, namely, creating an online community for registered users to participate in discussions, get feedback from their peers, form virtual communities, engage in social networking, and exchange documents; computer technology advice provided to Internet users by means of a support hotline; computer service relating to creating indexes of information, sites and resources on computer networks; providing search engines; design of computers, notebook computers, laptop computers, portable computers and handheld computers; design of personal digital assistants and personal media players; design of mobile telephones and smart phones; design of digital cameras; computer services; computer programming; computer integration services; computer analysis services; computer programming in relation to the defence against virus; computer system software services; computer software design; computer system design; design and development of webpages; hosting webpages for others; hosting computer application software for searching and retrieving information from databases and computer networks; providing technical information at the specific request of end-users by means of telephone or global computer network; consultancy services in relation to computer software; computer services relating to customized searching of computer databases and websites; computer and electronic signal coding and decoding; conversion of physical data and documents into electronic media format; product testing and evaluation services; architectural and design services; interior designs of buildings, offices and apartments; computer information services; network information services,

namely, providing technical information relating to computers and networks in the field of business and e-commerce; provision of computer security risk management programs; computer security information, knowledge, and testing services; quality assurance services; computer services relating to certification of business transactions and preparation of reports therefor; access control to (security services for-) computers, electronic networks and databases; security of data transmission services and of transactions via computer networks services; consultancy in the field of data security; technological consultancy concerning securing telecommunications; computerized communication network security services; providing information in the fields of Internet, world wide web and computerized communication network security and the secure transmission of data and information; consulting services in the fields of Internet, world wide web and computerized communication network security services, information security services; authentication services for computer security; online authentication of electronic signatures; off-site data backup; electronic data storage; providing information on computer technology and programming via a web site; cartography services; cloud computing; cloud hosting provider services; providing temporary use of non-downloadable cloud-based software and cloud computing software; electronic storage of data; providing virtual computer systems and virtual computer environments through cloud computing; rental of entertainment software; technical research in the field of carbon offsetting; provision of information, advice and consultancy in relation to carbon offsetting and environmental protection; providing technological information about environmentally-conscious and green innovations; environmental testing, assessment and monitoring services; research in the fields of environmental protection and conservation; research and provision of scientific information in the field of climate change; scientific and industrial consultation services relating to fuels, fuel and carbon dioxide emissions and environmental issues; scientific and technological services relating to recommendation of courses of action to reduce carbon dioxide emission in a cost effective manner; scientific and technological services relating to management of carbon offset programmes; environmental research,

management and protection services;
consultancy, information and advisory services
relating to the aforesaid services.

- [526] 卸棄: N/A
Disclaimer:
- [529] 限制: N/A
Limitation:
- [527] 條件: N/A
Condition:
其他: N/A
Others
- [220] 提交日期: 29-10-2021
Date of Filing:
- [320] 聲稱具有優先權的日期: N/A
Date of Priority Claimed:
- [310] 優先權申請編號: N/A
Priority Application Number:
- [340] 聲稱具有優先權 (部分): N/A
Priority Claim Details:
- [330] 優先權申請的
國家、地區、地方: N/A
Country, territory, area of
Priority Applications:

-
- [210] 商標申請編號: 305796532
Application No.:
- [540] 商標:
Mark:

ANTKAST

- [550] 商標種類: Ordinary
Mark Type:
一系列商標: NO
Series Mark:
- [571] 商標描述: N/A
Mark Description:
- [730] 註冊申請人的姓名 / 名稱、地址: Advanced New Technologies Co., Ltd.
Applicant(s) ' Cayman Corporate Centre, 27 Hospital Road,
Name,Address: George Town, Grand Cayman KY1-9008,
CAYMAN ISLANDS
- [740/ 註冊申請人的送達地址: SIMMONS & SIMMONS
750] Applicant's Address for 30th Floor, One Taikoo Place
Service: 979 King's Road,
HONG KONG
- [511] 類別編號: 9, 38, 41, 42
Class(es) No(s) .:

[511] 貨品 / 服務說明：
Specification:

Class 42:
Scientific and technological services and research and design relating thereto, industrial analysis and research services; design and development of computer hardware and software; software as a service (SaaS); blockchain as a service (BaaS); encryption, decryption and authentication of information, messages and data; providing user authentication services using biometric, facial recognition, finger print authentication, voice recognition and other types of hardware and software authentication technology for provision of financial services, e-commerce transactions, donations, licensed product tracking and fan engagement; data security services; IT security, protection and restoration; computer security threat analysis for protecting data; provision of security services for computer networks, computer access and computerised transactions; certification (quality control) of data via blockchain; data authentication via blockchain; including all of the aforementioned services for use in connection with payment systems; computer services in connection with transmitting information, data, documents, and images over the Internet; application service provider (ASP) services, namely, hosting computer software applications of others; application service provider (ASP) services providing software in the fields of web-based conferencing, audio conferencing, electronic messaging, document collaboration, video conferencing, and voice and call processing; providing online non-downloadable software for facilitating the interoperability of multiple software applications; technical support services relating to computer software and applications provided online, by email and by telephone; computer services, namely, creating an online community for registered users to participate in discussions, get feedback from their peers, form virtual communities, engage in social networking, and exchange documents; computer technology advice provided to Internet users by means of a support hotline; computer service relating to creating indexes of information, sites and resources on computer networks; providing search engines; design of computers, notebook computers, laptop computers, portable computers and handheld computers; design of personal digital assistants and personal media players; design of mobile telephones and smart phones; design of digital cameras; computer

services; computer programming; computer integration services; computer analysis services; computer programming in relation to the defence against virus; computer system software services; computer software design; computer system design; design and development of webpages; hosting webpages for others; hosting computer application software for searching and retrieving information from databases and computer networks; providing technical information at the specific request of end-users by means of telephone or global computer network; consultancy services in relation to computer software; computer services relating to customized searching of computer databases and websites; computer and electronic signal coding and decoding; conversion of physical data and documents into electronic media format; product testing and evaluation services; architectural and design services; interior designs of buildings, offices and apartments; computer information services; network information services, namely, providing technical information relating to computers and networks in the field of business and e-commerce; provision of computer security risk management programs; computer security information, knowledge, and testing services; quality assurance services; computer services relating to certification of business transactions and preparation of reports therefor; access control to (security services for-) computers, electronic networks and databases; security of data transmission services and of transactions via computer networks services; consultancy in the field of data security; technological consultancy concerning securing telecommunications; computerized communication network security services; providing information in the fields of Internet, world wide web and computerized communication network security and the secure transmission of data and information; consulting services in the fields of Internet, world wide web and computerized communication network security services, information security services; authentication services for computer security; online authentication of electronic signatures; off-site data backup; electronic data storage; providing information on computer technology and programming via a web site; cartography services; cloud computing; cloud hosting provider services; providing temporary use of non-downloadable cloud-based software and cloud computing software; electronic storage of data;

providing virtual computer systems and virtual computer environments through cloud computing; rental of entertainment software; technical research in the field of carbon offsetting; provision of information, advice and consultancy in relation to carbon offsetting and environmental protection; providing technological information about environmentally-conscious and green innovations; environmental testing, assessment and monitoring services; research in the fields of environmental protection and conservation; research and provision of scientific information in the field of climate change; scientific and industrial consultation services relating to fuels, fuel and carbon dioxide emissions and environmental issues; scientific and technological services relating to recommendation of courses of action to reduce carbon dioxide emission in a cost effective manner; scientific and technological services relating to management of carbon offset programmes; environmental research, management and protection services; consultancy, information and advisory services relating to the aforesaid services.

- [526] 卸棄 : N/A
Disclaimer:
- [529] 限制 : N/A
Limitation:
- [527] 條件 : N/A
Condition:
其他 : N/A
Others
- [220] 提交日期 : 09-11-2021
Date of Filing:
- [320] 聲稱具有優先權的日期 : N/A
Date of Priority Claimed:
- [310] 優先權申請編號 : N/A
Priority Application Number:
- [340] 聲稱具有優先權 (部分) : N/A
Priority Claim Details:
- [330] 優先權申請的
國家、地區、地方 : N/A
Country, territory, area of
Priority Applications:

-
- [210] 商標申請編號 : 305796839
Application No.:

[540] 商標 :
Mark:

TUGRAPH

[550] 商標種類 : Ordinary

Mark Type:

一系列商標 :

NO

Series Mark:

[571] 商標描述 : N/A

Mark Description:

[730] 註冊申請人的姓名 / 名稱、地址 :

Applicant(s)'

Name,Address:

Advanced New Technologies Co., Ltd.

Cayman Corporate Centre, 27 Hospital Road,

George Town, Grand Cayman KY1-9008,

CAYMAN ISLANDS

[740/ 註冊申請人的送達地址 :

SIMMONS & SIMMONS

750] Applicant's Address for

Service:

30th Floor, One Taikoo Place

979 King's Road,

HONG KONG

[511] 類別編號 :

9, 36, 42

Class(es) No(s) .:

[511] 貨品 / 服務說明 :

Specification:

Class 42:

Scientific and technological services and research and design relating thereto, industrial analysis and research services; design and development of computer hardware and software; software as a service (SaaS); blockchain as a service (BaaS); encryption, decryption and authentication of information, messages and data; providing user authentication services using biometric, facial recognition, finger print authentication, voice recognition and other types of hardware and software authentication technology for provision of financial services, e-commerce transactions, donations, licensed product tracking and fan engagement; data security services; IT security, protection and restoration; computer security threat analysis for protecting data; provision of security services for computer networks, computer access and computerised transactions; certification (quality control) of data via blockchain; data authentication via blockchain; including all of the aforementioned services for use in connection with payment systems; computer services in connection with transmitting information, data, documents, and images over the Internet; application service provider (ASP) services, namely, hosting computer software applications of others; application service provider (ASP) services providing software in the fields of web-based conferencing, audio conferencing, electronic messaging, document collaboration,

video conferencing, and voice and call processing; providing online non-downloadable software for facilitating the interoperability of multiple software applications; technical support services relating to computer software and applications provided online, by email and by telephone; computer services, namely, creating an online community for registered users to participate in discussions, get feedback from their peers, form virtual communities, engage in social networking, and exchange documents; computer technology advice provided to Internet users by means of a support hotline; computer service relating to creating indexes of information, sites and resources on computer networks; providing search engines; design of computers, notebook computers, laptop computers, portable computers and handheld computers; design of personal digital assistants and personal media players; design of mobile telephones and smart phones; design of digital cameras; computer services; computer programming; computer integration services; computer analysis services; computer programming in relation to the defence against virus; computer system software services; computer software design; computer system design; design and development of webpages; hosting webpages for others; hosting computer application software for searching and retrieving information from databases and computer networks; providing technical information at the specific request of end-users by means of telephone or global computer network; consultancy services in relation to computer software; computer services relating to customized searching of computer databases and websites; computer and electronic signal coding and decoding; conversion of physical data and documents into electronic media format; product testing and evaluation services; architectural and design services; interior designs of buildings, offices and apartments; computer information services; network information services, namely, providing technical information relating to computers and networks in the field of business and e-commerce; provision of computer security risk management programs; computer security information, knowledge, and testing services; quality assurance services; computer services relating to certification of business transactions and preparation of reports therefor; access control to (security services for-) computers, electronic networks and databases; security of data transmission

services and of transactions via computer networks services; consultancy in the field of data security; technological consultancy concerning securing telecommunications; computerized communication network security services; providing information in the fields of Internet, world wide web and computerized communication network security and the secure transmission of data and information; consulting services in the fields of Internet, world wide web and computerized communication network security services, information security services; authentication services for computer security; online authentication of electronic signatures; off-site data backup; electronic data storage; providing information on computer technology and programming via a web site; cartography services; cloud computing; cloud hosting provider services; providing temporary use of non-downloadable cloud-based software and cloud computing software; electronic storage of data; providing virtual computer systems and virtual computer environments through cloud computing; rental of entertainment software; technical research in the field of carbon offsetting; provision of information, advice and consultancy in relation to carbon offsetting and environmental protection; providing technological information about environmentally-conscious and green innovations; environmental testing, assessment and monitoring services; research in the fields of environmental protection and conservation; research and provision of scientific information in the field of climate change; scientific and industrial consultation services relating to fuels, fuel and carbon dioxide emissions and environmental issues; scientific and technological services relating to recommendation of courses of action to reduce carbon dioxide emission in a cost effective manner; scientific and technological services relating to management of carbon offset programmes; environmental research, management and protection services; consultancy, information and advisory services relating to the aforesaid services.

- [526] 卸棄 : N/A
Disclaimer:
- [529] 限制 : N/A
Limitation:
- [527] 條件 : N/A
Condition:
- 其他 : N/A

Others

[220] 提交日期: 09-11-2021

Date of Filing:

[320] 聲稱具有優先權的日期: N/A

Date of Priority Claimed:

[310] 優先權申請編號: N/A

Priority Application Number:

[340] 聲稱具有優先權 (部分): N/A

Priority Claim Details:

[330] 優先權申請的: N/A

國家、地區、地方:

Country, territory, area of

Priority Applications:

[210] 商標申請編號: 305797531

Application No.:

[540] 商標:

Mark:



[550] 商標種類: Ordinary

Mark Type:

一系列商標: NO

Series Mark:

[571] 商標描述: The applicant claims the colours black, white and red as elements of the trade mark.

Mark Description:

[730] 註冊申請人的姓名 / 名稱、地址: ORIENT OVERSEAS CONTAINER LINE LIMITED

Applicant(s) '

Name, Address:

31/F HARBOUR CENTRE,
25 HARBOUR ROAD, WANCHAI,
HONG KONG

[740/ 註冊申請人的送達地址: MARKS & CLERK

750] Applicant's Address for

Service:

Level 9, Cyberport 1
100 Cyberport Road, Pok Fu Lam
HONG KONG

[511] 類別編號: 9, 35, 36, 39, 42

Class(es) No(s) .:

[511] 貨品 / 服務說明:

Specification:

Class 42:

Provision of non-downloadable software applications in relation to transportation, logistics and storage services; hosting computer sites (web sites); conversion of data or documents from physical to electronic media; computer software design; provision of non-downloadable computer software containing business and finance information and facilitating the exchange of information in the field of transportation, logistics and

storage services; data conversion of computer programs and data (not physical conversion); computer services in the provision of system log function and error checking capability which can present detailed information on transportation, logistics and storage activities that are managed or supported through e-commerce or electronic data interchange services.

- [526] 卸棄 : N/A
Disclaimer:
- [529] 限制 : N/A
Limitation:
- [527] 條件 : N/A
Condition:
其他 : N/A
Others
- [220] 提交日期 : 10-11-2021
Date of Filing:
- [320] 聲稱具有優先權的日期 : N/A
Date of Priority Claimed:
- [310] 優先權申請編號 : N/A
Priority Application Number:
- [340] 聲稱具有優先權 (部分) : N/A
Priority Claim Details:
- [330] 優先權申請的
國家、地區、地方 : N/A
Country, territory, area of
Priority Applications:

- [210] 商標申請編號 : 305797540
Application No.:

- [540] 商標 : A
Mark: **FREIGHTSMART**
B
FreightSmart

- [550] 商標種類 : Ordinary
Mark Type:
一系列商標 : YES
Series Mark:
- [571] 商標描述 : N/A
Mark Description:

- [730] 註冊申請人的姓名 / 名稱、地址 : ORIENT OVERSEAS CONTAINER LINE LIMITED
Applicant(s)' 31/F HARBOUR CENTRE,
Name,Address: 25 HARBOUR ROAD, WANCHAI,
HONG KONG
- [740/ 註冊申請人的送達地址 : MARKS & CLERK
750] Applicant's Address for Level 9, Cyberport 1
Service: 100 Cyberport Road, Pok Fu Lam
HONG KONG
- [511] 類別編號 : 9,35,36,39,42
Class(es) No(s) .:
- [511] 貨品 / 服務說明 : Class 42:
Specification: Provision of non-downloadable software applications in relation to transportation, logistics and storage services; hosting computer sites (web sites); conversion of data or documents from physical to electronic media; computer software design; provision of non-downloadable computer software containing business and finance information and facilitating the exchange of information in the field of transportation, logistics and storage services; data conversion of computer programs and data (not physical conversion); computer services in the provision of system log function and error checking capability which can present detailed information on transportation, logistics and storage activities that are managed or supported through e-commerce or electronic data interchange services.
- [526] 卸棄 : N/A
Disclaimer:
- [529] 限制 : N/A
Limitation:
- [527] 條件 : N/A
Condition:
- 其他 : N/A
Others
- [220] 提交日期 : 10-11-2021
Date of Filing:
- [320] 聲稱具有優先權的日期 : N/A
Date of Priority Claimed:
- [310] 優先權申請編號 : N/A
Priority Application Number:
- [340] 聲稱具有優先權 (部分) : N/A
Priority Claim Details:
- [330] 優先權申請的 N/A
國家、地區、地方 :
Country, territory, area of
Priority Applications:
-
-

[210] 商標申請編號 : 305798189

Application No.:

[540] 商標 :

Mark:



[550] 商標種類 : Ordinary

Mark Type:

一系列商標 :

NO

Series Mark:

[571] 商標描述 : N/A

Mark Description:

[730] 註冊申請人的姓名 / 名稱、地址 :

NortonLifeLock Inc.

Applicant(s)'

60 E Rio Salado Parkway, Suite 1000,

Name,Address:

Tempe, Arizona 85281,

UNITED STATES OF AMERICA

[740/ 註冊申請人的送達地址 :

WILKINSON & GRIST

750] Applicant's Address for

6th Floor, Prince's Building

Service:

Chater Road, Central

HONG KONG

[511] 類別編號 : 9,35,36,38,42,45

Class(es) No(s) .:

[511] 貨品 / 服務說明 :

Class 42:

Specification:

Scientific and technological services and research and design relating thereto; industrial analysis, industrial research and industrial design services; quality control and authentication services; design and development of computer hardware and software; computer services, namely, detection of computer viruses and computer security threats; Computer services, namely, data recovery services; computer software installation services; computer support services, namely, technical support in the nature of troubleshooting by diagnosing problems with computer software and software update services; computer systems analysis in the field of security, access, authorization, authentication encryption, and identification systems for computers and computer networks; computer virus protection services; development, updating, and maintenance of software for networks and standalone computers in the fields of security, and anti-virus protection and monitoring; electronic monitoring of computer networks for security purposes for protecting data and information from unauthorized access; updating of computer software; electronic storage of data; computer software consultation; encryption and decryption of data and communications; identity theft protection services, namely,

fraud prevention in the form of computerized and electronic monitoring of personal and financial information; on-line technical support services, namely, troubleshooting in the nature of diagnosing of computer hardware and software problems; providing information about assessing computer security relating to protecting data, preventing computer threats relating to protecting data, and design and development of computer security hardware and software applications; providing information in the field of computer network and Internet information security; providing information in the field of information technology relating to communications devices, computers, computer hardware, computer software, computer peripherals, and computer networks; computer services, namely, providing search engines for obtaining data on a global computer network; providing information in the field of network and Internet information security relating to protecting data and information from unauthorized access; providing security threat management systems relating to protecting information and data from unauthorized access, namely, electronic monitoring and tracking of security vulnerabilities and problems in computer software products, the Internet, and computer networks; providing security threat management systems for protecting data, namely, monitoring and tracking of security vulnerabilities and problems in computer software products, the Internet, and computer networks; providing technical information in the field of computer software applications; providing a secure interactive website that features technology that enables the sending of notifications of potential fraud and potential identity theft; software as a service featuring software for use in scanning networks and websites to detect and identify vulnerabilities and malware; technical and customer support services, namely, troubleshooting of computer software problems; technical consultation in the field of computer software installation and maintenance; electronic data back-up services; technical support services, namely, troubleshooting in the nature of diagnosing computer hardware and software problems; updating of computer software for others; computer security services in the nature of providing authentication, issuance, validation and revocation of digital certificates; providing online non-downloadable software that provides alerts and notifications to

users regarding potential identity theft, fictitious identity monitoring, credit fraud, dark web activity, gaming account credential theft, investment account activity, social media account takeovers, phone number takeovers, home title records scanning, and court records scanning; software as a service (SaaS) featuring software for storing and retrieving login credentials securely and generating strong passwords; providing information on protecting data and information from unauthorized use, namely, information on protection related to consumer credit, fraud and identity theft (data security services); software as a service (SaaS) services featuring software for securely backing up and archiving electronic data; cybersecurity services in the nature of restricting unauthorized access to computer systems; data encryption services; providing online non-downloadable software for use providing network, Internet, and computer security; providing online non-downloadable software for use in anonymous browsing, encryption, antitracking protection, network protection, privacy protection, data compression, and data leakage prevention; consumer data security threat analysis, namely, monitoring public reports concerning larger scale consumer data security breaches for fraud protection purposes via the internet; providing online non-downloadable software for mining virtual currencies or virtual assets via the Internet; computer security services for cryptocurrency mining via the Internet, namely, data encryption services; computer programming services, namely, programming computer software for cryptocurrency mining and blockchain purposes; computer maintenance services, namely, maintenance of computer software for cryptocurrency mining and blockchain purposes; providing online non-downloadable computer software for use as an electronic wallet to allow users to store and transfer virtual currency and cryptocurrency; electronic data storage, namely, storage of virtual currency and cryptocurrency; providing user authentication services using blockchain-based software technology for cryptocurrency transactions; authentication of data in the field of cryptocurrency using blockchain technology; providing online non-downloadable cryptocurrency mining pool software; cloud-based mining of cryptocurrency for others, namely, cryptocurrency mining pool services in the nature of online non-downloadable software

for cryptocurrency mining; computer services, namely, providing temporary use of online non-downloadable software that allows others to share computing processing power over a network; hosting computer software for use by others in the field of cryptocurrency mining, namely, software allowing users to verify cryptocurrency transactions for others in order to generate cryptocurrency.

- [526] 卸棄 : N/A
Disclaimer:
- [529] 限制 : N/A
Limitation:
- [527] 條件 : N/A
Condition:
其他 : N/A
Others
- [220] 提交日期 : 10-11-2021
Date of Filing:
- [320] 聲稱具有優先權的日期 : N/A
Date of Priority Claimed:
- [310] 優先權申請編號 : N/A
Priority Application Number:
- [340] 聲稱具有優先權 (部分) : N/A
Priority Claim Details:
- [330] 優先權申請的
國家、地區、地方 : N/A
Country, territory, area of
Priority Applications:

-
-
- [210] 商標申請編號 : 305808394
Application No.:
- [540] 商標 :
Mark:



[550] 商標種類: Ordinary
Mark Type:
一系列商標: NO
Series Mark:

[571] 商標描述: N/A
Mark Description:

[730] 註冊申請人的姓名 / 名稱、地址: Chan Zuckerberg Initiative, LLC
Applicant(s) ' 2682 Middlefield Road, Suite i,
Name,Address: Redwood City, California 94063,
UNITED STATES OF AMERICA

[740/ 註冊申請人的送達地址: MINTERELLISON LLP
750] Applicant's Address for Level 32, Wu Chung House
Service: 213 Queen's Road East
HONG KONG

[511] 類別編號: 36,41,42
Class(es) No(s) .:

[511] 貨品 / 服務說明: Class 42:
Specification: Development and design of computer software
for others; development of biomedical
technologies and products for others

[526] 卸棄: N/A
Disclaimer:

[529] 限制: N/A
Limitation:

[527] 條件: N/A
Condition:
其他: N/A
Others

[220] 提交日期: 22-11-2021
Date of Filing:

[320] 聲稱具有優先權的日期: 02-06-2021
Date of Priority Claimed:

[310] 優先權申請編號: 90750307
Priority Application Number:

[340] 聲稱具有優先權 (部分): N/A
Priority Claim Details:

[330] 優先權申請的 UNITED STATES OF AMERICA
國家、地區、地方:
Country, territory, area of
Priority Applications:

[210] 商標申請編號: 305808402
Application No.:

[540] 商標 :
Mark:

CZI

[550] 商標種類 : Ordinary
Mark Type:
一系列商標 : NO
Series Mark:

[571] 商標描述 : N/A
Mark Description:

[730] 註冊申請人的姓名 / 名稱、地址 : Chan Zuckerberg Initiative, LLC
Applicant(s) ' 2682 Middlefield Road, Suite i,
Name, Address: Redwood City, California 94063,
UNITED STATES OF AMERICA

[740/ 註冊申請人的送達地址 : MINTERELLISON LLP
750] Applicant's Address for Level 32, Wu Chung House
Service: 213 Queen's Road East
HONG KONG

[511] 類別編號 : 36, 41, 42
Class(es) No(s) .:

[511] 貨品 / 服務說明 : Class 42:
Specification: Development and design of computer software
for others; development of biomedical
technologies and products for others

[526] 卸棄 : N/A
Disclaimer:

[529] 限制 : N/A
Limitation:

[527] 條件 : N/A
Condition:

其他 : N/A
Others

[220] 提交日期 : 22-11-2021
Date of Filing:

[320] 聲稱具有優先權的日期 : 02-06-2021
Date of Priority Claimed:

[310] 優先權申請編號 : 90750294
Priority Application Number:

[340] 聲稱具有優先權 (部分) : N/A
Priority Claim Details:

[330] 優先權申請的 UNITED STATES OF AMERICA
國家、地區、地方 :
Country, territory, area of
Priority Applications:

[210] 商標申請編號 : 305808411
Application No.:

[540] 商標 :
Mark: **CHAN ZUCKERBERG INITIATIVE**

[550] 商標種類 : Ordinary
Mark Type:
一系列商標 : NO
Series Mark:

[571] 商標描述 : N/A
Mark Description:

[730] 註冊申請人的姓名 / 名稱、地址 : Chan Zuckerberg Initiative, LLC
Applicant(s) ' 2682 Middlefield Road, Suite i,
Name, Address: Redwood City, California 94063,
UNITED STATES OF AMERICA

[740/ 註冊申請人的送達地址 : MINTERELLISON LLP
750] Applicant's Address for Level 32, Wu Chung House
Service: 213 Queen's Road East
HONG KONG

[511] 類別編號 : 36, 41, 42
Class(es) No(s) .:

[511] 貨品 / 服務說明 : Class 42:
Specification: Development and design of computer software
for others; development of biomedical
technologies and products for others

[526] 卸棄 : N/A
Disclaimer:

[529] 限制 : N/A
Limitation:

[527] 條件 : N/A
Condition:
其他 : N/A
Others

[220] 提交日期 : 22-11-2021
Date of Filing:

[320] 聲稱具有優先權的日期 : 02-06-2021
Date of Priority Claimed:

[310] 優先權申請編號 : 90750268
Priority Application Number:

[340] 聲稱具有優先權 (部分) : N/A
Priority Claim Details:

[330] 優先權申請的 UNITED STATES OF AMERICA
國家、地區、地方 :
Country, territory, area of
Priority Applications:

- [210] 商標申請編號 : 305808592
Application No.:
- [540] 商標 :
Mark:
- 
- [550] 商標種類 : Ordinary
Mark Type:
一系列商標 : NO
Series Mark:
- [571] 商標描述 : N/A
Mark Description:
- [730] 註冊申請人的姓名 / 名稱、地址 : L'OREAL
Applicant (s) ' 14 RUE ROYALE,
Name, Address: 75008 PARIS,
FRANCE
- [740/ 註冊申請人的送達地址 : BAKER & MCKENZIE
750] Applicant's Address for 14TH FLOOR, ONE TAIKOO PLACE,
Service: 979 KING'S ROAD, QUARRY BAY,
HONG KONG
- [511] 類別編號 : 35, 41, 42
Class(es) No(s) .:
- [511] 貨品 / 服務說明 : Class 42:
Specification: Providing a website featuring information on
recycling of cosmetics packaging.
- [526] 卸棄 : N/A
Disclaimer:
- [529] 限制 : N/A
Limitation:
- [527] 條件 : N/A
Condition:
其他 : N/A
Others
- [220] 提交日期 : 22-11-2021
Date of Filing:
- [320] 聲稱具有優先權的日期 : 18-10-2021
Date of Priority Claimed:
- [310] 優先權申請編號 : 4809428
Priority Application Number:
- [340] 聲稱具有優先權 (部分) : N/A
Priority Claim Details:
- [330] 優先權申請的 國家、地區、地方 : FRANCE
Country, territory, area of
Priority Applications:

[210] 商標申請編號 : 305809456

Application No.:

[540] 商標 : A

Mark:



B



[550] 商標種類 : Ordinary

Mark Type:

一系列商標 : YES

Series Mark:

[571] 商標描述 : The applicant claims the colour blue as an element of mark "A" in the series.

Mark Description:

[730] 註冊申請人的姓名 / 名稱、地址 :

FIND GROUP LIMITED

Applicant(s)'

13/F., OTB Building

Name,Address:

259-265 Des Voeux Road Central, Sheung Wan
HONG KONG

[740/ 註冊申請人的送達地址 :

FIND GROUP LIMITED

750] Applicant's Address for

13/F., OTB Building

Service:

259-265 Des Voeux Road Central, Sheung Wan
HONG KONG

[511] 類別編號 : 35,36,42

Class(es) No(s) .:

[511] 貨品 / 服務說明 : Class 42:

Specification:

Computer services, namely, creating an on-line community for registered users to participate in discussions, get feedback from their peers, from virtual communities, and engage in social networking services in the field of real estate products and services; all included in class 42.

[526] 卸棄 : N/A

Disclaimer:

[529] 限制 : N/A

Limitation:

[527] 條件 :	N/A
Condition:	
其他 :	N/A
Others	
[220] 提交日期 :	23-11-2021
Date of Filing:	
[320] 聲稱具有優先權的日期 :	N/A
Date of Priority Claimed:	
[310] 優先權申請編號 :	N/A
Priority Application Number:	
[340] 聲稱具有優先權 (部分) :	N/A
Priority Claim Details:	
[330] 優先權申請的 國家、地區、地方 :	N/A
Country, territory, area of Priority Applications:	
<hr/>	
[210] 商標申請編號 :	305810238
Application No.:	
[540] 商標 :	A
Mark:	
	B
	
[550] 商標種類 :	Ordinary
Mark Type:	
一系列商標 :	YES
Series Mark:	
[571] 商標描述 :	The applicant claims the colour red (Pantone 186C) as an element of mark "A" in the series.
Mark Description:	
[730] 註冊申請人的姓名 / 名稱、地址 :	GPower Holdings Group Company Limited
Applicant(s)' Name, Address:	Unit 9, 8th Floor, Fortune Commercial Building 362 Sha Tsui Road, Tsuen Wan HONG KONG
[740/ 註冊申請人的送達地址 :	CFN Lawyers in association with Broad and
750] Applicant's Address for Service:	Bright Room Nos. 4101-04, 41/F, Sun Hung Kai Centre 30 Harbour Road, Wan Chai, HONG KONG
[511] 類別編號 :	16, 35, 42
Class(es) No(s) .:	
[511] 貨品 / 服務說明 :	Class 42:
Specification:	Scientific and technological services and research and design relating thereto; industrial analysis and research services; design and development of computer hardware and software; all included in Class 42.

[526]	卸棄:	N/A
	Disclaimer:	
[529]	限制:	N/A
	Limitation:	
[527]	條件:	N/A
	Condition:	
	其他:	N/A
	Others	
[220]	提交日期:	23-11-2021
	Date of Filing:	
[320]	聲稱具有優先權的日期:	N/A
	Date of Priority Claimed:	
[310]	優先權申請編號:	N/A
	Priority Application Number:	
[340]	聲稱具有優先權 (部分):	N/A
	Priority Claim Details:	
[330]	優先權申請的	N/A
	國家、地區、地方:	
	Country, territory, area of	
	Priority Applications:	
<hr/>		
[210]	商標申請編號:	305813668
	Application No.:	
[540]	商標:	
	Mark:	
		KAMISMAX
[550]	商標種類:	Ordinary
	Mark Type:	
	一系列商標:	NO
	Series Mark:	
[571]	商標描述:	N/A
	Mark Description:	
[730]	註冊申請人的姓名 / 名稱、地址:	INVADE Co., Ltd.
	Applicant(s)'	GINZA SIX 11F, 6-10-1, Ginza,
	Name,Address:	Chuo-ku, Tokyo,
		JAPAN
[740/	註冊申請人的送達地址:	MAYER BROWN
750]	Applicant's Address for	16th-19th Floors, Prince's Building,
	Service:	10 Chater Road, Central,
		HONG KONG
[511]	類別編號:	3, 9, 35, 41, 42, 44
	Class(es) No(s) .:	

[511] 貨品 / 服務說明 : Specification:	Class 42: Platform as a service [PaaS]; providing computer programs on data networks; provision of information regarding provision of computer programs; rental of memory space on the server; rental of a database server; hosting of web sites; cloud computing; provision of information regarding rental of computers; rental of computers; provision of Internet search engines; computer network configuration services; data encryption services; off-site data backup; provision of information relating to computer programming; computer software design, computer programming, or maintenance of computer software; provision of technical information in relation to computers; computer system analysis; technological advice relating to computers, automobiles and industrial machines; designing, other than for advertising purposes; providing meteorological information; provision of information relating to technological research; testing, inspection or research of pharmaceuticals, cosmetics or foodstuffs; research on building construction or city planning; testing or research on prevention of pollution; testing or research on electricity; testing or research on civil engineering; testing, inspection or research on agriculture, livestock breeding or fisheries; testing or research on machines, apparatus and instruments; architectural design; surveying; geological surveys or research; designing of machines, apparatus, instruments [including their parts] or systems composed of such machines, apparatus and instruments; rental of measuring apparatus; rental of laboratory apparatus and instruments; rental of technical drawing instruments.
[526] 卸棄 : Disclaimer:	N/A
[529] 限制 : Limitation:	N/A
[527] 條件 : Condition:	N/A
其他 : Others	N/A
[220] 提交日期 : Date of Filing:	25-11-2021
[320] 聲稱具有優先權的日期 : Date of Priority Claimed:	09-11-2021
[310] 優先權申請編號 : Priority Application Number:	2021-139384
[340] 聲稱具有優先權 (部分) :	N/A

Priority Claim Details:

[330] 優先權申請的 JAPAN
國家、地區、地方：
Country, territory, area of
Priority Applications:

[210] 商標申請編號： 305815297
Application No.:

[540] 商標：
Mark:

BIENVI

[550] 商標種類： Ordinary
Mark Type:
一系列商標： NO
Series Mark:

[571] 商標描述： N/A
Mark Description:

[730] 註冊申請人的姓名 / 名稱、地址： GlaxoSmithKline Consumer Healthcare (UK) IP
Applicant(s) ' Limited
Name, Address: 980 Great West Road,
Brentford, Middlesex, TW8 9GS, England
UNITED KINGDOM

[740/ 註冊申請人的送達地址： WILKINSON & GRIST
750] Applicant's Address for 6th Floor, Prince's Building
Service: Chater Road, Central
HONG KONG

[511] 類別編號： 3, 5, 9, 10, 21, 29, 30, 32, 35, 36, 41, 42, 44
Class(es) No(s) .:

[511] 貨品 / 服務說明： Class 42:
Specification: Scientific research for medical and healthcare
purposes.

[526] 卸棄： N/A
Disclaimer:

[529] 限制： N/A
Limitation:

[527] 條件： N/A
Condition:
其他： N/A
Others

[220] 提交日期： 29-11-2021
Date of Filing:

[320] 聲稱具有優先權的日期： 03-06-2021
Date of Priority Claimed:

[310] 優先權申請編號： 83440
Priority Application Number:

[340] 聲稱具有優先權 (部分): for Classes 3, 5, 9, 10, 21, 29, 30, 32, 35,
Priority Claim Details: 41, 42 and 44

[330] 優先權申請的 JAMAICA
國家、地區、地方:
Country, territory, area of
Priority Applications:

[210] 商標申請編號: 305815314
Application No.:

[540] 商標:
Mark:

HALEON

[550] 商標種類: Ordinary
Mark Type:
一系列商標: NO
Series Mark:

[571] 商標描述: N/A
Mark Description:

[730] 註冊申請人的姓名 / 名稱、地址: GlaxoSmithKline Consumer Healthcare (UK) IP
Applicant(s) ' Limited
Name, Address: 980 Great West Road,
Brentford, Middlesex, TW8 9GS, England,
UNITED KINGDOM

[740/ 註冊申請人的送達地址: WILKINSON & GRIST
750] Applicant's Address for 6th Floor, Prince's Building
Service: Chater Road, Central
HONG KONG

[511] 類別編號: 3, 5, 9, 10, 21, 29, 30, 32, 35, 36, 41, 42, 44
Class(es) No(s) .:

[511] 貨品 / 服務說明: Class 42:
Specification: Scientific research for medical and healthcare
purposes.

[526] 卸棄: N/A
Disclaimer:

[529] 限制: N/A
Limitation:

[527] 條件: N/A
Condition:
其他: N/A
Others

[220] 提交日期: 29-11-2021
Date of Filing:

[320] 聲稱具有優先權的日期: 03-06-2021
Date of Priority Claimed:

[310] 優先權申請編號: 83438

Priority Application Number:

- [340] 聲稱具有優先權 (部分): for Classes 3, 5, 9, 10, 21, 29, 30, 32, 35, 41, 42 and 44
Priority Claim Details:
- [330] 優先權申請的 JAMAICA
國家、地區、地方:
Country, territory, area of
Priority Applications:

- [210] 商標申請編號: 305822055
Application No.:

- [540] 商標:
Mark:

ComEasy
管理易

- [550] 商標種類: Ordinary
Mark Type:
一系列商標: NO
Series Mark:
- [571] 商標描述: N/A
Mark Description:
- [730] 註冊申請人的姓名 / 名稱、地址: Perfect Event Services Limited
Applicant(s) ' Unit 1, 7/F, Kai Fuk Industrial Centre,
Name,Address: 1 Wang Tung Street, Kowloon Bay, Kowloon
HONG KONG
- [740/ 註冊申請人的送達地址: Ng Wing Chun / FSE Engineering Group Limited
750] Applicant's Address for Units 801-810, Chevalier Commercial Centre,
Service: No.8 Wang Hoi Road, Kowloon Bay, Kowloon
HONG KONG
- [511] 類別編號: 9, 35, 36, 38, 42, 45
Class(es) No(s).:
- [511] 貨品 / 服務說明: Class 42:
Specification: Consultation in environment protection and
quality control; conversion of data or
documents from physical to electronic media.
- [526] 卸棄: N/A
Disclaimer:
- [529] 限制: N/A
Limitation:
- [527] 條件: N/A
Condition:
其他: N/A
Others
- [220] 提交日期: 06-12-2021
Date of Filing:

[320] 聲稱具有優先權的日期 : N/A
Date of Priority Claimed:
[310] 優先權申請編號 : N/A
Priority Application Number:
[340] 聲稱具有優先權 (部分) : N/A
Priority Claim Details:
[330] 優先權申請的 N/A
國家、地區、地方 :
Country, territory, area of
Priority Applications:

[210] 商標申請編號 : 305825539
Application No.:

[540] 商標 :
Mark:



[550] 商標種類 : Ordinary
Mark Type:
一系列商標 : NO
Series Mark:

[571] 商標描述 : N/A
Mark Description:

[730] 註冊申請人的姓名 / 名稱、地址 : C.P.E. HOLDING COMPANY DI IMMOVILLI LUCIANO
Applicant(s) ' Strada Mulino Lombardi, 7
Name, Address: 42027 MONTECCHIO EMILIA (REGGIO EMILIA)
ITALY

[740/ 註冊申請人的送達地址 : WENPING PATENT & TRADE MARK AGENT LIMITED
750] Applicant's Address for 1701 Tung Wai Commercial Building,
Service: 111 Gloucester Road,
HONG KONG

[511] 類別編號 : 14, 35, 42
Class(es) No(s) .:

[511] 貨品 / 服務說明 : Class 42:
Specification: Industrial analysis, of industrial research
and of industrial design; Quality control and
authentication services; Design services;
Industrial and graphic art design; Product

design; Art work design; Design of glass and of glass products; Design in relation to the following goods: Jewellery, Articles of jewellery; Design of watches.

- [526] 卸棄: N/A
Disclaimer:
- [529] 限制: N/A
Limitation:
- [527] 條件: N/A
Condition:
其他: N/A
Others
- [220] 提交日期: 08-12-2021
Date of Filing:
- [320] 聲稱具有優先權的日期: 21-10-2021
Date of Priority Claimed:
- [310] 優先權申請編號: 302021000174965
Priority Application Number:
- [340] 聲稱具有優先權 (部分): N/A
Priority Claim Details:
- [330] 優先權申請的
國家、地區、地方: ITALY
Country, territory, area of
Priority Applications:
-
-

- [210] 商標申請編號: 305825692
Application No.:
- [540] 商標: A
Mark:

畢安維

B

毕安维

- [550] 商標種類: Ordinary
Mark Type:
一系列商標: YES
Series Mark:
- [571] 商標描述: N/A
Mark Description:

[730] 註冊申請人的姓名 / 名稱、地址 : GlaxoSmithKline Consumer Healthcare (UK) IP
Applicant(s) ' Limited
Name, Address: 980 Great West Road,
Brentford, Middlesex, TW8 9GS, England,
UNITED KINGDOM

[740/ 註冊申請人的送達地址 : WILKINSON & GRIST
750] Applicant's Address for 6th Floor, Prince's Building
Service: Chater Road, Central
HONG KONG

[511] 類別編號 : 3, 5, 9, 10, 21, 29, 30, 32, 35, 36, 41, 42, 44
Class(es) No(s) .:

[511] 貨品 / 服務說明 : Class 42:
Specification: Scientific research for medical and healthcare
purposes.

[526] 卸棄 : N/A
Disclaimer:

[529] 限制 : N/A
Limitation:

[527] 條件 : N/A
Condition:

其他 : N/A
Others

[220] 提交日期 : 08-12-2021
Date of Filing:

[320] 聲稱具有優先權的日期 : N/A
Date of Priority Claimed:

[310] 優先權申請編號 : N/A
Priority Application Number:

[340] 聲稱具有優先權 (部分) : N/A
Priority Claim Details:

[330] 優先權申請的 N/A
國家、地區、地方 :
Country, territory, area of
Priority Applications:

[210] 商標申請編號 : 305825700
Application No.:

[540] 商標 :
Mark:

赫力昂

[550] 商標種類 : Ordinary
Mark Type:
一系列商標 : NO
Series Mark:

[571] 商標描述 : N/A
Mark Description:

[730] 註冊申請人的姓名 / 名稱、地址 : GlaxoSmithKline Consumer Healthcare (UK) IP
Applicant(s) ' Limited
Name, Address: 980 Great West Road,
Brentford, Middlesex, TW8 9GS, England,
UNITED KINGDOM

[740/ 註冊申請人的送達地址 : WILKINSON & GRIST
750] Applicant's Address for 6th Floor, Prince's Building
Service: Chater Road, Central
HONG KONG

[511] 類別編號 : 3, 5, 9, 10, 21, 29, 30, 32, 35, 36, 41, 42, 44
Class(es) No(s) .:

[511] 貨品 / 服務說明 : Class 42:
Specification: Scientific research for medical and healthcare
purposes.

[526] 卸棄 : N/A
Disclaimer:

[529] 限制 : N/A
Limitation:

[527] 條件 : N/A
Condition:
其他 : N/A
Others

[220] 提交日期 : 08-12-2021
Date of Filing:

[320] 聲稱具有優先權的日期 : N/A
Date of Priority Claimed:

[310] 優先權申請編號 : N/A
Priority Application Number:

[340] 聲稱具有優先權 (部分) : N/A
Priority Claim Details:

[330] 優先權申請的 : N/A
國家、地區、地方 :
Country, territory, area of
Priority Applications:

[210] 商標申請編號 : 305831587
Application No.:

[540] 商標 : **THE IMPSIDER**
Mark:

[550] 商標種類 : Ordinary
Mark Type:

- 一系列商標 : NO
Series Mark:
- [571] 商標描述 : N/A
Mark Description:
- [730] 註冊申請人的姓名 / 名稱、地址 : Sony Interactive Entertainment Europe Limited
Applicant(s) ' 10 Great Marlborough Street,
Name,Address: London, W1F 7LP,
UNITED KINGDOM
- [740/ 註冊申請人的送達地址 : MINTERELLISON LLP
750] Applicant's Address for Level 32, Wu Chung House
Service: 213 Queen's Road East
HONG KONG
- [511] 類別編號 : 9,38,41,42
Class(es) No(s) .:
- [511] 貨品 / 服務說明 : Class 42:
Specification: Computer services; provision of technical support in the field of computer games software; designing of computer games programs and video games programs; developing of computer games programs and video games programs; testing of computer games programs and video games programs; information and advisory services relating to the aforesaid services; technical information and support in the fields of computer game software, computer game hardware and on-line computer games; Design and development of multimedia products; Design of audio-visual creative works; Design of games; Graphic arts design; Software as a service [SaaS]; Platforms for gaming as software as a service [SaaS]; Platform as a Service [PaaS]; Software as a service [SaaS] featuring software platforms for electronic gaming; providing online, non-downloadable game engine software used to create and assemble 2D and 3D graphics and art, music, special effects, gameplay logic, and animations for interactive entertainment; providing online, non-downloadable game engine software used to create digital works of art for interactive entertainment; providing online, non-downloadable game engine software for video game development and operation for video game entertainment; hosting on-line web facilities for interactive game play; computer services in the nature of customised web pages for featuring game player information, including information regarding a player's identity and the player's preferences; hosting websites for video and computer games or parts of video or computer games created by others on a computer service for a global network.
- [526] 卸棄 : N/A
Disclaimer:

[529] 限制 : Limitation:	N/A
[527] 條件 : Condition:	N/A
其他 : Others	N/A
[220] 提交日期 : Date of Filing:	15-12-2021
[320] 聲稱具有優先權的日期 : Date of Priority Claimed:	16-06-2021
[310] 優先權申請編號 : Priority Application Number:	UK00003656419
[340] 聲稱具有優先權 (部分) : Priority Claim Details:	N/A
[330] 優先權申請的 國家、地區、地方 : Country, territory, area of Priority Applications:	UNITED KINGDOM
<hr/>	
[210] 商標申請編號 : Application No.:	305831604
[540] 商標 : Mark:	DREAMIVERSE
[550] 商標種類 : Mark Type:	Ordinary
一系列商標 : Series Mark:	NO
[571] 商標描述 : Mark Description:	N/A
[730] 註冊申請人的姓名 / 名稱、地址 : Applicant(s) ' Name, Address:	Sony Interactive Entertainment Europe Limited 10 Great Marlborough Street, London, W1F 7LP, UNITED KINGDOM
[740/ 註冊申請人的送達地址 : 750] Applicant's Address for Service:	MINTERELLISON LLP Level 32, Wu Chung House 213 Queen's Road East HONG KONG
[511] 類別編號 : Class(es) No(s) .:	9, 14, 16, 18, 25, 28, 38, 41, 42
[511] 貨品 / 服務說明 : Specification:	Class 42: Computer services; provision of technical support in the field of computer games software; designing of computer games programs and video games programs; developing of computer games programs and video games

programs; testing of computer games programs and video games programs; information and advisory services relating to the aforesaid services; technical information and support in the fields of computer game software, computer game hardware and on-line computer games; Design and development of multimedia products; Design of audio-visual creative works; Design of games; Graphic arts design; Software as a service [SaaS]; Platforms for gaming as software as a service [SaaS]; Platform as a Service [PaaS]; Software as a service [SaaS] featuring software platforms for electronic gaming; hosting on-line web facilities for interactive game play; computer services in the nature of customised web pages for featuring game player information, including information regarding a player's identity and the player's preferences; hosting websites for video and computer games or parts of video or computer games created by others on a computer service for a global network.

- [526] 卸棄 : N/A
Disclaimer:
- [529] 限制 : N/A
Limitation:
- [527] 條件 : N/A
Condition:
其他 : N/A
Others
- [220] 提交日期 : 15-12-2021
Date of Filing:
- [320] 聲稱具有優先權的日期 : 18-06-2021
Date of Priority Claimed:
- [310] 優先權申請編號 : UK00003657440
Priority Application Number:
- [340] 聲稱具有優先權 (部分) : N/A
Priority Claim Details:
- [330] 優先權申請的
國家、地區、地方 : UNITED KINGDOM
Country, territory, area of
Priority Applications:

- [210] 商標申請編號 : 305833530
Application No.:

- [540] 商標 :

PERIDOT

Mark:

[550] 商標種類: Ordinary
 Mark Type:
 一系列商標: NO
 Series Mark:

[571] 商標描述: N/A
 Mark Description:

[730] 註冊申請人的姓名 / 名稱、地址: Niantic, Inc.
 Applicant(s) ' 1 Ferry Building, Suite 200,
 Name,Address: San Francisco, California 94111,
 UNITED STATES OF AMERICA

[740/ 註冊申請人的送達地址: Rouse & Co. International (Overseas) Limited
 750] Applicant's Address for 26/F., Tesbury Centre,
 Service: 28 Queen's Road East
 HONG KONG

[511] 類別編號: 9,41,42,45
 Class(es) No(s) .:

[511] 貨品 / 服務說明: Class 42:
 Specification: Providing online non-downloadable game
 software; providing online non-downloadable
 video game software; providing online non-
 downloadable interactive game software;
 providing online non-downloadable augmented
 reality game software; providing online non-
 downloadable game software for creating,
 customizing, and interacting with an animal-
 like character; providing virtual computer
 environments in which users can interact for
 recreational, leisure or entertainment
 purposes.

[526] 卸棄: N/A
 Disclaimer:

[529] 限制: N/A
 Limitation:

[527] 條件: N/A
 Condition:
 其他: N/A
 Others

[220] 提交日期: 16-12-2021
 Date of Filing:

[320] 聲稱具有優先權的日期: 29-06-2021
 Date of Priority Claimed:

[310] 優先權申請編號: 083656
 Priority Application Number:

[340] 聲稱具有優先權 (部分): N/A
 Priority Claim Details:

[330] 優先權申請的 JAMAICA
 國家、地區、地方:
 Country, territory, area of
 Priority Applications:

[210] 商標申請編號 : 305838229
Application No.:

[540] 商標 : A
Mark:



B



[550] 商標種類 : Ordinary
Mark Type:
一系列商標 : YES

Series Mark:

[571] 商標描述 : The applicant claims the colours blue and red
Mark Description: as elements of mark "A" in the series.

[730] 註冊申請人的姓名 / 名稱、地址 : CHINA STATE CONSTRUCTION ENGINEERING (HONG
Applicant(s) ' KONG) LIMITED (中國建築工程 (香港) 有限公司)
Name,Address: 29th Floor, China Overseas Building,
139 Hennessy Road, Wan Chai,
HONG KONG

[740/ 註冊申請人的送達地址 : SFKS CK KWONG, SOLICITORS

750] Applicant's Address for 17th Floor, Chu Kong Shipping Tower,
Service: No. 143 Connaught Road Central,
HONG KONG

[511] 類別編號 : 9,37,42

Class(es) No(s) .:

[511] 貨品 / 服務說明 : Class 42:
Specification: Scientific and technological services and
research and design relating thereto;
industrial analysis, industrial research and
industrial design services; quality control

and authentication services; design and development of computer hardware and software; cloud computing; custom design of health care equipment; computer and Internet security system monitoring services; computer security system monitoring services; computer data analysis services; research in the field of artificial intelligence; providing temporary use of on-line non-downloadable cloud computing software for providing business intelligence, business data analytics, and for collecting and analyzing business data; software as a service (SAAS) services featuring software for collecting, managing and reporting on data from connected computer systems, digital mobile devices, and Internet of Things (IoT) devices; software as a service (SaaS) services for the control and monitoring of cloud computing networks and Internet of Things (IoT) devices; infrastructure as a service (IaaS) services for use with Internet of Things (IoT) devices and networks; software as a service (SAAS) featuring computer software development tools; software as a service (SAAS) featuring software for image analysis, recognition and enhancement; software as a service (SAAS) featuring software to connect, authenticate and manage internet of things electronic devices; cloud computing; platform as a service [PaaS]; updating and maintenance of computer software; design and development of multimedia products; research and development of computer software; software design and development; providing online non-downloadable computer software for security information and event management (SIEM) employing artificial intelligence and machine learning to enable automated responses in real time to security vulnerabilities, threats, and events; Software as a Service (SaaS), namely software for allowing real time updates to software applications accessible by multiple parties; providing temporary use of online non-downloadable software for finding and displaying a user's location and global positioning system (GPS) tracking devices

- [526] 卸棄 : N/A
Disclaimer:
- [529] 限制 : N/A
Limitation:
- [527] 條件 : N/A
Condition:
- 其他 : N/A
Others

[220] 提交日期: 21-12-2021
Date of Filing:
[320] 聲稱具有優先權的日期: N/A
Date of Priority Claimed:
[310] 優先權申請編號: N/A
Priority Application Number:
[340] 聲稱具有優先權 (部分): N/A
Priority Claim Details:
[330] 優先權申請的
國家、地區、地方: N/A
Country, territory, area of
Priority Applications:

[210] 商標申請編號: 305839589
Application No.:
[540] 商標:
Mark:

极智嘉

[550] 商標種類: 一般商標
Mark Type:
一系列商標: 否
Series Mark:
[571] 商標描述: 不適用
Mark Description:
[730] 註冊申請人的姓名 / 名稱、地址: 北京極智嘉科技股份有限公司
Applicant(s) ' 中國
Name, Address: 北京市朝陽區
北苑路 30 號院 4 號樓 1 至 10 層 101 號 7 層 701
[740/ 註冊申請人的送達地址: 三友知識產權代理有限公司
750] Applicant's Address for 香港
Service: 中環德己立街 38-44 號
好利商業大廈 6 字樓 A 室
[511] 類別編號: 7, 9, 12, 42
Class(es) No(s) .:
[511] 貨品 / 服務說明: 類別 42:
Specification: 技術研究; 技術項目研究; 提供產品研究和開發服務; 替他人研
究和開發新產品; 質量控制; 車輛性能檢測; 包裝設計; 工業品外
觀設計; 自動控制系統之設計; 雲計算; 軟件即服務 (SaaS)
; 平臺即服務 (PaaS) ; 計算機編程; 計算機軟件設計; 計算

機軟件安裝; 計算機軟件更新; 計算機軟件維護; 計算機軟件出租; 計算機平臺的開發; 計算機硬件設計和開發諮詢; 計算機系統遠程監控; 替他人研究和開發自動化倉儲解決方案產品; 控制自動化倉儲機器人用計算機軟件的設計、開發與維護; 設計用於控制自助服務終端的計算機軟件; 與自動化倉儲解決方案相關的技術研究和開發。

- [526] 卸棄: 不適用
Disclaimer:
- [529] 限制: 不適用
Limitation:
- [527] 條件: 不適用
Condition:
其他: 不適用
Others
- [220] 提交日期: 22-12-2021
Date of Filing:
- [320] 聲稱具有優先權的日期: 不適用
Date of Priority Claimed:
- [310] 優先權申請編號: 不適用
Priority Application Number:
- [340] 聲稱具有優先權 (部分): 不適用
Priority Claim Details:
- [330] 優先權申請的 不適用
國家、地區、地方:
Country, territory, area of
Priority Applications:

- [210] 商標申請編號: 305840794
Application No.:

- [540] 商標: A
Mark:



B



[550] 商標種類 :	Ordinary
Mark Type:	
一系列商標 :	YES
Series Mark:	
[571] 商標描述 :	N/A
Mark Description:	
[730] 註冊申請人的姓名 / 名稱、地址 :	KREW LIMITED
Applicant(s) ' Name, Address:	16/F., King Palace Plaza, 52A Sha Tsui Road, Tsuen Wan, N.T., HONG KONG
[740/ 註冊申請人的送達地址 :	KREW LIMITED
750] Applicant's Address for Service:	16/F., King Palace Plaza, 52A Sha Tsui Road, Tsuen Wan, N.T., HONG KONG
[511] 類別編號 :	35, 38, 41, 42
Class(es) No(s) .:	
[511] 貨品 / 服務說明 :	Class 42:
Specification:	Art work design; design and development of web pages; design and hosting of websites; design and maintenance of web applications; graphic design; website design; website creation and hosting services.
[526] 卸棄 :	N/A
Disclaimer:	
[529] 限制 :	N/A
Limitation:	
[527] 條件 :	N/A
Condition:	
其他 :	N/A
Others	
[220] 提交日期 :	23-12-2021
Date of Filing:	
[320] 聲稱具有優先權的日期 :	N/A
Date of Priority Claimed:	
[310] 優先權申請編號 :	N/A
Priority Application Number:	
[340] 聲稱具有優先權 (部分) :	N/A

Priority Claim Details:

[330] 優先權申請的 N/A
國家、地區、地方：
Country, territory, area of
Priority Applications:

[210] 商標申請編號： 305840811
Application No.:

[540] 商標： A
Mark:



B



[550] 商標種類： Ordinary
Mark Type:
一系列商標： YES
Series Mark:

[571] 商標描述： N/A
Mark Description:

[730] 註冊申請人的姓名 / 名稱、地址： KREW LIMITED
Applicant(s) ' 16/F., King Palace Plaza,
Name,Address: 52A Sha Tsui Road, Tsuen Wan, N.T.,
HONG KONG

[740/ 註冊申請人的送達地址： KREW LIMITED
750] Applicant's Address for 16/F., King Palace Plaza,
Service: 52A Sha Tsui Road, Tsuen Wan, N.T.,
HONG KONG

[511] 類別編號： 35, 38, 41, 42
Class(es) No(s) .:

[511] 貨品 / 服務說明： Class 42:
Specification: Art work design; design and development of web
pages; design and hosting of websites; design
and maintenance of web applications; graphic
design; website design; website creation and
hosting services; hosting of digital social
media content; hosting of online multi-media
content; all included in Class 42.

[526] 卸棄： N/A
Disclaimer:

[529] 限制： N/A
Limitation:

[527]	條件 :	N/A
	Condition:	
	其他 :	N/A
	Others	
[220]	提交日期 :	23-12-2021
	Date of Filing:	
[320]	聲稱具有優先權的日期 :	N/A
	Date of Priority Claimed:	
[310]	優先權申請編號 :	N/A
	Priority Application Number:	
[340]	聲稱具有優先權 (部分) :	N/A
	Priority Claim Details:	
[330]	優先權申請的 國家、地區、地方 :	N/A
	Country, territory, area of Priority Applications:	
<hr/>		
[210]	商標申請編號 :	305840839
	Application No.:	
[540]	商標 :	A
	Mark:	
		B
		
[550]	商標種類 :	Ordinary
	Mark Type:	
	一系列商標 :	YES
	Series Mark:	
[571]	商標描述 :	N/A
	Mark Description:	
[730]	註冊申請人的姓名 / 名稱、地址 :	KREW LIMITED
	Applicant(s) ' Name, Address:	16/F., King Palace Plaza, 52A Sha Tsui Road, Tsuen Wan, N.T., HONG KONG
[740/	註冊申請人的送達地址 :	KREW LIMITED
750]	Applicant's Address for Service:	16/F., King Palace Plaza, 52A Sha Tsui Road, Tsuen Wan, N.T., HONG KONG
[511]	類別編號 :	35, 38, 42
	Class(es) No(s) .:	
[511]	貨品 / 服務說明 :	Class 42:
	Specification:	Computer services relating to internet analytics; rental of computer software and programs; design and development of computer programs and software; computer system analysis; recovery of computer data;

maintenance of computer software; all included in Class 42.

- [526] 卸棄: N/A
Disclaimer:
- [529] 限制: N/A
Limitation:
- [527] 條件: N/A
Condition:
其他: N/A
Others
- [220] 提交日期: 23-12-2021
Date of Filing:
- [320] 聲稱具有優先權的日期: N/A
Date of Priority Claimed:
- [310] 優先權申請編號: N/A
Priority Application Number:
- [340] 聲稱具有優先權 (部分): N/A
Priority Claim Details:
- [330] 優先權申請的
國家、地區、地方: N/A
Country, territory, area of
Priority Applications:

-
- [210] 商標申請編號: 305840875
Application No.:
- [540] 商標:
Mark:



Alchemy 16

- [550] 商標種類: Ordinary
Mark Type:
一系列商標: NO
Series Mark:
- [571] 商標描述: N/A
Mark Description:

[730] 註冊申請人的姓名 / 名稱、地址 :
Applicant(s)'
Name, Address: ALCHEMY 16 LIMITED
18/F ON HING BUILDING
1. ON HING TERRACE CENTRAL,
HONG KONG

[740/ 註冊申請人的送達地址 :
750] Applicant's Address for
Service: ALCHEMY 16 LIMITED
18/F ON HING BUILDING
1 ON HING TERRACE
HONG KONG

[511] 類別編號 :
Class(es) No(s) .: 35,36,41,42

[511] 貨品 / 服務說明 :
Specification: Class 42:
Computer programming; authenticating works of
art; (PaaS) Platform as a Service;
installation of computer software; data
conversion of computer programs and data [not
physical conversion]; software as a service
(SAAS) in relation to featuring computer
software for blockchain technology, featuring
computer software for cryptocurrency,
featuring computer software for digital
currencies and featuring computer software for
cryptocurrency asset management; industrial
design; authenticating works of art; cloud
computing; cloud computing service.

[526] 卸棄 :
Disclaimer: N/A

[529] 限制 :
Limitation: N/A

[527] 條件 :
Condition: N/A

其他 :
Others: N/A

[220] 提交日期 :
Date of Filing: 23-12-2021

[320] 聲稱具有優先權的日期 :
Date of Priority Claimed: N/A

[310] 優先權申請編號 :
Priority Application Number: N/A

[340] 聲稱具有優先權 (部分) :
Priority Claim Details: N/A

[330] 優先權申請的
國家、地區、地方 :
Country, territory, area of
Priority Applications: N/A

[210] 商標申請編號 :
Application No.: 305842657

[540] 商標 :

Mark:



[550] 商標種類 :

Ordinary

Mark Type:

一系列商標 :

NO

Series Mark:

[571] 商標描述 :

Mark Description:

The applicant claims the colors dark blue, blue and light blue as elements of the trademark.

[730] 註冊申請人的姓名 / 名稱、地址 :

Applicant(s)'

Name, Address:

LENGOW
6 RUE RENÉ VIVIANI,
44200 NANTES,
FRANCE

[740/ 註冊申請人的送達地址 :

750] Applicant's Address for Service:

CHINA PATENT AGENT (HONG KONG) LIMITED
22/F, Great Eagle Centre,
23 Harbour Road, Wanchai,
HONG KONG

[511] 類別編號 :

Class(es) No(s) .:

9,14,16,18,21,25,35,38,42

[511] 貨品 / 服務說明 :

Specification:

Class 42:

Software as a service [SaaS]; Assessment, estimations and research in the field of science and technology provided by engineers; Design and development of computer hardware and software; Research and development of new products for others; Technical project studies; Development (design), installation, maintenance, rental, updating of computer software, computer programming; Consultancy in the field of computer hardware and software; Conversion of computer programs and data, other than physical conversion ; Conversion of data or documents from physical to electronic media; Computer system analysis; Recovery of computer data; Computer system design; Creating and maintaining web sites for others; Duplication of computer programs; Providing search engines for the internet; Hosting computer sites; Surveying; Rental of web servers; Rental of computer, Computer virus protection services ; All the aforesaid services being for the processing of databases of catalogues containing physical goods and goods of tour operators (except catalogues for promoting services) of traders and online trader for the purpose of their advertising dissemination via the Internet.

[526] 卸棄 :

Disclaimer:

N/A

[529] 限制 :

Limitation:

N/A

[527] 條件 : N/A
Condition:
其他 : N/A
Others

[220] 提交日期 : 24-12-2021
Date of Filing:

[320] 聲稱具有優先權的日期 : N/A
Date of Priority Claimed:

[310] 優先權申請編號 : N/A
Priority Application Number:

[340] 聲稱具有優先權 (部分) : N/A
Priority Claim Details:

[330] 優先權申請的
國家、地區、地方 : N/A
Country, territory, area of
Priority Applications:

[210] 商標申請編號 : 305843476
Application No.:

[540] 商標 :
Mark:

A



B



iMeddy

[550] 商標種類 : 一般商標
Mark Type:

一系列商標 : 是

Series Mark:

[571] 商標描述 : 申請人聲稱綠色為商標的一個要素。

Mark Description:

- [730] 註冊申請人的姓名 / 名稱、地址 : Tech Creation Medical Service Limited
Applicant(s) ' 香港
Name, Address: 上環德輔道中 317-319
啟德商業大廈 1406-1407 室
- [740/ 註冊申請人的送達地址 : Tech Creation Medical Service Limited
750] Applicant's Address for 香港
Service: 上環德輔道中 317-319 號
啟德商業大廈 1406-07 室
- [511] 類別編號 : 35, 42
Class(es) No(s) .:
- [511] 貨品 / 服務說明 : 類別 42:
Specification: 服務器託管; 信息技術諮詢服務; 城市規劃; 科學技術服務和與
之相關的研究與設計服務; 科學實驗室服務; 計算機出租; 計算
機軟件出租; 計算機軟件安裝和維護; 計算機硬件與軟件的設計
與開發; 託管計算機站(網站); 軟件運營服務[SaaS]; 通過網站
提供計算機技術和編程信息; 提供互聯網搜索引擎; 替他人創建
和維護網站; 雲運算; 電子數據存儲
- [526] 卸棄 : 不適用
Disclaimer:
- [529] 限制 : 不適用
Limitation:
- [527] 條件 : 不適用
Condition:
其他 : 不適用
Others
- [220] 提交日期 : 28-12-2021
Date of Filing:
- [320] 聲稱具有優先權的日期 : 不適用
Date of Priority Claimed:
- [310] 優先權申請編號 : 不適用
Priority Application Number:
- [340] 聲稱具有優先權 (部分) : 不適用
Priority Claim Details:
- [330] 優先權申請的 不適用
國家、地區、地方 :
Country, territory, area of
Priority Applications:

[210] 商標申請編號 : 305844989
Application No.:

[540] 商標 :
Mark:

VIDESPACE

[550] 商標種類 : Ordinary
Mark Type:

一系列商標 : NO
Series Mark:

[571] 商標描述 : N/A
Mark Description:

[730] 註冊申請人的姓名 / 名稱、地址 : INFOMINA SDN BHD
Applicant(s) ' B03-C-12-1, MENARA 3A, NO. 3 JLN BANGSAR, KL
Name,Address: ECO
CITY, 59200, KUALA LUMPUR,
MALAYSIA

[740/ 註冊申請人的送達地址 : HONG KONG DECENT INTELLECTUAL PROPERTY AGENT
750] Applicant's Address for LIMITED
Service: 3RD Floor Workington Tower,
78 Bonham Strand,
HONG KONG

[511] 類別編號 : 42
Class(es) No(s) .:

[511] 貨品 / 服務說明 : Class 42:
Specification: computer hardware design;computer software
design;computer software consultancy;computer
software development;advisory services
relating to software development;consultancy
relating to computer software;maintenance,
updating and design of computer
software;computer security
consultancy;computer technology
consultancy;data security
consultancy;information technology [IT]
consultancy; telecommunications technology
consultancy.

[526] 卸棄 : N/A
Disclaimer:

[529] 限制 : N/A
Limitation:

[527] 條件 : N/A
Condition:
其他 : N/A
Others

[220] 提交日期 : 28-12-2021
Date of Filing:

[320] 聲稱具有優先權的日期 : N/A
Date of Priority Claimed:

[310] 優先權申請編號 : N/A
Priority Application Number:

[340] 聲稱具有優先權 (部分) : N/A
Priority Claim Details:

[330] 優先權申請的
國家、地區、地方 : N/A
Country, territory, area of
Priority Applications:

[210] 商標申請編號: 305845384
Application No.:

[540] 商標: A
Mark:



B



[550] 商標種類: Ordinary

Mark Type:

一系列商標: YES

Series Mark:

[571] 商標描述: The applicant claims the colors black, dark blue, blue and light blue as elements of marks (A) and (B) in the series.
Mark Description:

[730] 註冊申請人的姓名 / 名稱、地址: LENGOW
Applicant(s) ' 6 RUE RENÉ VIVIANI,
Name,Address: 44200 NANTES,
FRANCE

[740/ 註冊申請人的送達地址: CHINA PATENT AGENT (HONG KONG) LIMITED
750] Applicant's Address for 22/F, Great Eagle Centre,
Service: 23 Harbour Road, Wanchai,
HONG KONG

[511] 類別編號: 9,14,16,18,21,25,35,38,42

Class(es) No(s) .:

[511] 貨品 / 服務說明: Class 42:
Specification: Software as a service [SaaS]; Assessment, estimations and research in the field of science and technology provided by engineers; Design and development of computer hardware and software; Research and development of new products for others; Technical project studies; Development (design), installation, maintenance, rental, updating of computer software, computer programming; Consultancy in the field of computer hardware and software; Conversion of computer programs and data, other than physical conversion ; Conversion of data or documents from physical to electronic

media; Computer system analysis; Recovery of computer data; Computer system design; Creating and maintaining web sites for others; Duplication of computer programs; Providing search engines for the internet; Hosting computer sites; Surveying; Rental of web servers; Rental of computer, Computer virus protection services ; All the aforesaid services being for the processing of databases of catalogues containing physical goods and goods of tour operators (except catalogues for promoting services) of traders and online trader for the purpose of their advertising dissemination via the Internet.

- [526] 卸棄 : N/A
Disclaimer:
- [529] 限制 : N/A
Limitation:
- [527] 條件 : N/A
Condition:
其他 : N/A
Others
- [220] 提交日期 : 29-12-2021
Date of Filing:
- [320] 聲稱具有優先權的日期 : N/A
Date of Priority Claimed:
- [310] 優先權申請編號 : N/A
Priority Application Number:
- [340] 聲稱具有優先權 (部分) : N/A
Priority Claim Details:
- [330] 優先權申請的
國家、地區、地方 : N/A
Country, territory, area of
Priority Applications:

-
- [210] 商標申請編號 : 305845393
Application No.:
- [540] 商標 : A
Mark:

LENGOW乐售
法国

B

LENGOW樂售

法國

- [550] 商標種類 : Ordinary
Mark Type:
一系列商標 : YES
Series Mark:
- [571] 商標描述 : N/A
Mark Description:
- [730] 註冊申請人的姓名 / 名稱、地址 : LENGOW
Applicant (s) ' 6 RUE RENÉ VIVIANI,
Name,Address: 44200 NANTES,
FRANCE
- [740/ 註冊申請人的送達地址 : CHINA PATENT AGENT (HONG KONG) LIMITED
750] Applicant's Address for 22/F, Great Eagle Centre,
Service: 23 Harbour Road, Wanchai,
HONG KONG
- [511] 類別編號 : 9,14,16,18,21,25,35,38,42
Class(es) No(s) .:
- [511] 貨品 / 服務說明 : Class 42:
Specification: Software as a service [SaaS]; Assessment, estimations and research in the field of science and technology provided by engineers; Design and development of computer hardware and software; Research and development of new products for others; Technical project studies; Development (design), installation, maintenance, rental, updating of computer software, computer programming; Consultancy in the field of computer hardware and software; Conversion of computer programs and data, other than physical conversion ; Conversion of data or documents from physical to electronic media; Computer system analysis; Recovery of computer data; Computer system design; Creating and maintaining web sites for others; Duplication of computer programs; Providing search engines for the internet; Hosting computer sites; Surveying; Rental of web servers; Rental of computer, Computer virus protection services ; All the aforesaid services being for the processing of databases of catalogues containing physical goods and goods of tour operators (except catalogues for promoting services) of traders and online trader for the purpose of their advertising dissemination via the Internet.
- [526] 卸棄 : N/A
Disclaimer:

[529] 限制 : Limitation:	N/A
[527] 條件 : Condition:	N/A
其他 : Others	N/A
[220] 提交日期 : Date of Filing:	29-12-2021
[320] 聲稱具有優先權的日期 : Date of Priority Claimed:	N/A
[310] 優先權申請編號 : Priority Application Number:	N/A
[340] 聲稱具有優先權 (部分) : Priority Claim Details:	N/A
[330] 優先權申請的 國家、地區、地方 : Country, territory, area of Priority Applications:	N/A

[210] 商標申請編號 : Application No.:	305845744
[540] 商標 : Mark:	A



B



- [550] 商標種類 : Ordinary
Mark Type:
一系列商標 : YES
Series Mark:
- [571] 商標描述 : N/A
Mark Description:
- [730] 註冊申請人的姓名 / 名稱、地址 : KAM, Kwok Yee Emmy
Applicant(s) ' Room 6, 10/F, Block B, Hi-Tech Industrial
Name,Address: Centre,
491-501 Castle Peak Road, Tsuen Wan, New
Territories,
HONG KONG
- [740/ 註冊申請人的送達地址 : ACCOLADE IP LIMITED
750] Applicant's Address for 10/F, Fu Fai Comm. Ctr.,
Service: 27 Hillier Street, Sheung Wan,
HONG KONG
- [511] 類別編號 : 29,42
Class(es) No(s) .:
- [511] 貨品 / 服務說明 : Class 42:
Specification: Design, programming, implementing and updating
of computer software and computer platform
software for providing information relating to
machinery and equipment, commissioning,
installation, maintenance and repair of
machinery and equipment as well as the repair
and replacement of electrical and mechanical
equipment, component of machinery and
equipment; Platform as a Service [PaaS] and
Software as a Service [SaaS] featuring
platforms and software for providing
information relating to machinery and
equipment, commissioning, installation,
maintenance and repair of machinery and
equipment as well as the repair and
replacement of electrical and mechanical
equipment, component of machinery and
equipment; design, research, programming and
development of computer software and computer
platform software for providing information
relating to machinery and equipment,
commissioning, installation, maintenance and
repair of machinery and equipment as well as
the repair and replacement of electrical and
mechanical equipment, component of machinery
and equipment; provision of information in
relation to the aforesaid via online website,
social media websites, mobile applications and
the Internet; all the aforesaid services
included in Class 42.
- [526] 卸棄 : N/A
Disclaimer:
- [529] 限制 : N/A
Limitation:
- [527] 條件 : N/A
Condition:

其他 : N/A
Others
[220] 提交日期 : 29-12-2021
Date of Filing:
[320] 聲稱具有優先權的日期 : N/A
Date of Priority Claimed:
[310] 優先權申請編號 : N/A
Priority Application Number:
[340] 聲稱具有優先權 (部分) : N/A
Priority Claim Details:
[330] 優先權申請的
國家、地區、地方 : N/A
Country, territory, area of
Priority Applications:

[210] 商標申請編號 : 305846653
Application No.:

[540] 商標 :
Mark:



[550] 商標種類 : 一般商標
Mark Type:

一系列商標 : 否

Series Mark:

[571] 商標描述 : 不適用

Mark Description:

[730] 註冊申請人的姓名 / 名稱、地址 : 成都星閱辰石文化發展有限公司
Applicant(s)'
Name, Address: 中國

中國 (四川) 自由貿易試驗區

成都高新區盛邦街 1108 號

[740/ 註冊申請人的送達地址 : 德龍知識產權集團 (香港) 有限公司
750] Applicant's Address for
Service: 香港

灣仔軒尼詩道 338 號

北海中心 10 樓 E 室

[511] 類別編號 : 9, 16, 35, 41, 42

Class(es) No(s) .:

[511] 貨品 / 服務說明： Specification:	類別 42： 包裝設計；工業品外觀設計；服裝設計；把有形的數據或文件轉換成電子媒體；計算機軟件安裝；計算機軟件維護；計算機硬件設計和開發諮詢；計算機軟件設計；電子數據存儲；雲計算；通過網站提供計算機技術和編程信息；廣告宣傳材料的平面設計。
[526] 卸棄： Disclaimer:	不適用
[529] 限制： Limitation:	不適用
[527] 條件： Condition: 其他： Others	不適用
[220] 提交日期： Date of Filing:	05-01-2022
[320] 聲稱具有優先權的日期： Date of Priority Claimed:	不適用
[310] 優先權申請編號： Priority Application Number:	不適用
[340] 聲稱具有優先權 (部分)： Priority Claim Details:	不適用
[330] 優先權申請的 國家、地區、地方： Country, territory, area of Priority Applications:	不適用

[210] 商標申請編號： Application No.:	305847030
[540] 商標： Mark:	

GeeWallet

[550] 商標種類： Mark Type:	一般商標
---------------------------	------

	一系列商標 :	否
	Series Mark:	
[571]	商標描述 :	不適用
	Mark Description:	
[730]	註冊申請人的姓名 / 名稱、地址 :	深圳市極匯科技有限公司
	Applicant(s) 'Name, Address:	中國
		深圳市福田區
		沙頭街道車公廟創建大廈 1603
[740/750]	註冊申請人的送達地址 :	港智國際知識產權代理有限公司
	Applicant's Address for Service:	香港
		上環德輔道中 272-284 號
		興業商業中心 5 樓 505 室
[511]	類別編號 :	36, 42
	Class(es) No(s) .:	
[511]	貨品 / 服務說明 :	類別 42:
	Specification:	數據加密服務; 通過技術手段為電子商務交易進行用戶認證服務; 計算機軟件設計; 計算機軟件更新; 計算機軟件維護; 替他人創建和維護網站; 網站設計諮詢; 軟件即服務 (SaaS); 信息技術諮詢服務; 軟件出版框架下的軟件開發。
[526]	卸棄 :	不適用
	Disclaimer:	
[529]	限制 :	不適用
	Limitation:	
[527]	條件 :	不適用
	Condition:	
	其他 :	不適用
	Others	
[220]	提交日期 :	30-12-2021
	Date of Filing:	
[320]	聲稱具有優先權的日期 :	不適用
	Date of Priority Claimed:	
[310]	優先權申請編號 :	不適用
	Priority Application Number:	
[340]	聲稱具有優先權 (部分) :	不適用
	Priority Claim Details:	
[330]	優先權申請的	不適用
	國家、地區、地方 :	
	Country, territory, area of Priority Applications:	
[210]	商標申請編號 :	305847409
	Application No.:	

[540] 商標 :	
Mark:	
[550] 商標種類 :	Ordinary
Mark Type:	
一系列商標 :	NO
Series Mark:	
[571] 商標描述 :	N/A
Mark Description:	
[730] 註冊申請人的姓名 / 名稱、地址 :	GOLDHORSE CAPITAL MANAGEMENT (HK) LIMITED
Applicant(s)'	Flat 06-07, 43/F., One Exchange Square,
Name,Address:	8 Connaught Place, Central,
	HONG KONG
[740/ 註冊申請人的送達地址 :	勁標國際知識產權代理有限公司
750] Applicant's Address for	香港
Service:	中環干諾道中 1 號
	AIA 友邦金融中心大廈 28 樓
[511] 類別編號 :	42
Class(es) No(s) .:	
[511] 貨品 / 服務說明 :	Class 42:
Specification:	technological research;software as a service [SaaS];computer software design;computer software consultancy;updating of computer software;conversion of data or documents from physical to electronic media;information technology [IT] consultancy;development of computer platforms;electronic data storage;Technical advice relating to operation of computers;Advice relating to the design of computer hardware;Product development consultation;Computer technology consultancy.
[526] 卸棄 :	N/A
Disclaimer:	
[529] 限制 :	N/A
Limitation:	
[527] 條件 :	N/A
Condition:	
其他 :	N/A
Others	
[220] 提交日期 :	24-01-2022
Date of Filing:	
[320] 聲稱具有優先權的日期 :	N/A
Date of Priority Claimed:	
[310] 優先權申請編號 :	N/A
Priority Application Number:	
[340] 聲稱具有優先權 (部分) :	N/A
Priority Claim Details:	
[330] 優先權申請的	N/A

國家、地區、地方：

Country, territory, area of

Priority Applications:

-
- [210] 商標申請編號： 305847968
Application No.:
- [540] 商標： Mark:

- [550] 商標種類： 一般商標
Mark Type:
- 一系列商標： 否
Series Mark:
- [571] 商標描述： 不適用
Mark Description:
- [730] 註冊申請人的姓名 / 名稱、地址： 澳門 MPASS 數字化生活服務一人有限公司
Applicant(s) ' 澳門
Name, Address: 宋玉生廣場 322-362 號
誠豐商業中心 3 樓 0 座
- [740/ 註冊申請人的送達地址： 麥仕奇知識產權
750] Applicant's Address for 香港
Service: 薄扶林 數碼港道 100 號
數碼港一座 9 樓
- [511] 類別編號： 9, 28, 35, 36, 39, 41, 42, 43
Class(es) No(s) .:
- [511] 貨品 / 服務說明： 類別 42：
Specification: 提供互聯網搜索引擎；雲計算；計算機遊戲軟件的設計和開發；
；計算機軟件設計；軟件即服務 (SaaS)；平台即服務 (PaaS)；
計算機程序和數據的數據轉換 (非有形轉換)；電子數據存儲；
通過單點登錄技術為在線應用軟件進行用戶認證服務；
通過技術手段為電子商務交易進行用戶認證服務。
- [526] 卸棄： 不適用
Disclaimer:
- [529] 限制： 不適用
Limitation:
- [527] 條件： 不適用
Condition:
- 其他： 不適用
Others
- [220] 提交日期： 31-12-2021
Date of Filing:
- [320] 聲稱具有優先權的日期： 不適用
Date of Priority Claimed:
- [310] 優先權申請編號： 不適用

Priority Application Number:

[340] 聲稱具有優先權 (部分): 不適用

Priority Claim Details:

[330] 優先權申請的 不適用

國家、地區、地方:

Country, territory, area of

Priority Applications:

[210] 商標申請編號: 305848020

Application No.:

[540] 商標:

Mark:



Whimark

[550] 商標種類: 一般商標

Mark Type:

一系列商標:

否

Series Mark:

[571] 商標描述: 不適用

Mark Description:

[730] 註冊申請人的姓名 / 名稱、地址:

Applicant(s) '

Name, Address:

深圳市前海手繪科技文化有限公司

中國

深圳市前海深港合作區

南山街道興海大道 3040 號前海世茂金融中心二期 1 棟 3607

BORSAM INTELLECTUAL PROPERTY LIMITED

香港

九龍旺角花園街 75-77 號

花園商業大廈 6 樓 605 室

9, 38, 41, 42, 45

[740/ 註冊申請人的送達地址:

750] Applicant's Address for

Service:

[511] 類別編號:

Class(es) No(s) .:

[511] 貨品 / 服務說明:

Specification:

類別 42:

包裝設計; 服裝設計; 把有形的數據或文件轉換成電子媒體;
軟件即服務 (SaaS); 計算機編程; 計算機軟件更新; 雲計算
; 地圖繪製服務; 計算機軟件安裝; 計算機軟件維護; 平面美
術設計; 計算機軟件設計

[526] 卸棄: 不適用
Disclaimer:

[529] 限制: 不適用
Limitation:

[527] 條件: 不適用
Condition:
其他: 不適用
Others

[220] 提交日期: 31-12-2021
Date of Filing:

[320] 聲稱具有優先權的日期: 不適用
Date of Priority Claimed:

[310] 優先權申請編號: 不適用
Priority Application Number:

[340] 聲稱具有優先權 (部分): 不適用
Priority Claim Details:

[330] 優先權申請的
國家、地區、地方: 不適用
Country, territory, area of
Priority Applications:

[210] 商標申請編號: 305848417
Application No.:

[540] 商標:
Mark:

Zenless Zone Zer0

[550] 商標種類: Ordinary
Mark Type:
一系列商標: NO
Series Mark:

[571] 商標描述: N/A
Mark Description:

[730] 註冊申請人的姓名 / 名稱、地址: COGNOSPHERE PTE. LTD. (識隙之城私人有限公司)
Applicant(s) ' 6 Raffles
Name, Address: Quay #14-02 048580
SINGAPORE

[740/ 註冊申請人的送達地址: UNITALEN ATTORNEYS AT LAW LIMITED
750] Applicant's Address for RM 1201, 12/F, GOLDEN ERA PLAZA,
Service: 39-55 SAI YEE ST, MONGKOK KLN,
HONG KONG

[511] 類別編號: 9, 41, 42
Class(es) No(s) .:

[511] 貨品 / 服務說明 : Specification:	Class 42: Computer programming; Computer software design; Maintenance of computer software; Updating of computer software; Design and development of computer game software; Consultancy in the design and development of computer hardware; Software as a service [SaaS]; Technological research; Cloud computing; Animation design for others; Computer graphics design services; Homepage and webpage design; Dress designing; Packaging design; Graphic arts designing; computer services relating to the hosting of websites; Rental of computer software; Information technology [IT] consultancy; Providing search engines for the internet; User authentication services using single sign-on technology for online software applications.
[526] 卸棄 : Disclaimer:	N/A
[529] 限制 : Limitation:	N/A
[527] 條件 : Condition: 其他 : Others	N/A N/A
[220] 提交日期 : Date of Filing:	31-12-2021
[320] 聲稱具有優先權的日期 : Date of Priority Claimed:	N/A
[310] 優先權申請編號 : Priority Application Number:	N/A
[340] 聲稱具有優先權 (部分) : Priority Claim Details:	N/A
[330] 優先權申請的 國家、地區、地方 : Country, territory, area of Priority Applications:	N/A

[210] 商標申請編號 : Application No.:	305848426
------------------------------------	-----------

[540] 商標 :
Mark:

絕區零

[550] 商標種類 : Ordinary
Mark Type:
一系列商標 : NO
Series Mark:

[571] 商標描述 : N/A
Mark Description:

[730] 註冊申請人的姓名 / 名稱、地址 : COGNOSPHERE PTE. LTD. (識隙之城私人有限公司)
Applicant(s) ' 6 Raffles
Name,Address: Quay #14-02 048580
SINGAPORE

[740/ 註冊申請人的送達地址 : UNITALEN ATTORNEYS AT LAW LIMITED
750] Applicant's Address for RM 1201, 12/F, GOLDEN ERA PLAZA,
Service: 39-55 SAI YEE ST, MONGKOK KLN,
HONG KONG

[511] 類別編號 : 9, 41, 42
Class(es) No(s) .:

[511] 貨品 / 服務說明 : Class 42:
Specification: Computer programming; Computer software design; Maintenance of computer software; Updating of computer software; Design and development of computer game software; Consultancy in the design and development of computer hardware; Software as a service [SaaS]; Technological research; Cloud computing; Animation design for others; Computer graphics design services; Homepage and webpage design; Dress designing; Packaging design; Graphic arts designing; computer services relating to the hosting of websites; Rental of computer software; Information technology [IT] consultancy; Providing search engines for the internet; User authentication services using single sign-on technology for online software applications.

[526] 卸棄 : N/A
Disclaimer:

[529] 限制 : N/A
Limitation:

[527] 條件 : N/A
Condition:

其他 : N/A
Others
[220] 提交日期 : 31-12-2021
Date of Filing:
[320] 聲稱具有優先權的日期 : N/A
Date of Priority Claimed:
[310] 優先權申請編號 : N/A
Priority Application Number:
[340] 聲稱具有優先權 (部分) : N/A
Priority Claim Details:
[330] 優先權申請的
國家、地區、地方 : N/A
Country, territory, area of
Priority Applications:

[210] 商標申請編號 : 305849010
Application No.:

[540] 商標 :
Mark:

GEO仔

[550] 商標種類 : Ordinary
Mark Type:
一系列商標 : NO
Series Mark:

[571] 商標描述 : N/A
Mark Description:

[730] 註冊申請人的姓名 / 名稱、地址 : Incloud Limited
Applicant(s) ' ROOM 1501 MILLENNIUM CITY 5
Name, Address: 418 KWUN TONG ROAD, KWUN TONG
HONG KONG

[740/ 註冊申請人的送達地址 : Tse Kei Chun
750] Applicant's Address for 31 A 9/F, BROADWAY,
Service: MEI FOO SUN CHUEN, KLN
HONG KONG

[511] 類別編號 : 42
Class(es) No(s) .:

[511] 貨品 / 服務說明 : Class 42:
Specification: Computer programming; computer software
consultancy; computer software design;
computer system design and analysis;
installation, updating and maintenance of
computer software; computer software rental;
scientific and technological services and
research and design relating thereto;
industrial analysis and industrial research

services; design and development of computer hardware and software; cloud computing; creating and maintaining web sites for others; design and development of computer hardware and software; hosting computer sites [web sites]; land surveying; providing information on computer technology and programming via a web site; providing search engines for the internet; scientific and technological services and research and design relating thereto; server hosting; software as a service [SaaS].

[526] 卸棄 : N/A
Disclaimer:

[529] 限制 : N/A
Limitation:

[527] 條件 : N/A
Condition:
其他 : N/A
Others

[220] 提交日期 : 03-01-2022
Date of Filing:

[320] 聲稱具有優先權的日期 : N/A
Date of Priority Claimed:

[310] 優先權申請編號 : N/A
Priority Application Number:

[340] 聲稱具有優先權 (部分) : N/A
Priority Claim Details:

[330] 優先權申請的
國家、地區、地方 : N/A
Country, territory, area of
Priority Applications:

[210] 商標申請編號 : 305849461
Application No.:

[540] 商標 :
Mark:

GeoMOVE

[550] 商標種類 : Ordinary
Mark Type:
一系列商標 : NO
Series Mark:

[571] 商標描述 : N/A
Mark Description:

[730] 註冊申請人的姓名 / 名稱、地址 : Location Ai Technology Limited
Applicant(s)' Room 2308, 23/F, CEO Tower,
Name,Address: 77 Wing Hong Street, Lai Chi Kok, Kowloon
HONG KONG

[740/ 註冊申請人的送達地址 : WENPING PATENT & TRADE MARK AGENT LIMITED
750] Applicant's Address for 1701 Tung Wai Commercial Building,
Service: 111 Gloucester Road,
HONG KONG

[511] 類別編號 : 9,42
Class(es) No(s) .:

[511] 貨品 / 服務說明 : Class 42:
Specification: Advanced product research in the field of
artificial intelligence; application service
provider (ASP) services featuring application
programming interface (API) software for
artificial intelligence (AI), machine
learning, deep learning, statistical learning
and data mining to enable contextual
prediction, personalization, predictive
analytics, predictive modeling and business
intelligence services; appraising of designs
using artificial intelligence; collaborative
computer programming; computer programming and
software design; data mining; database design
and development; design and updating of
software for embedded devices and software
maintenance services, computer systems
analysis; design of computer databases; design
of interior décor; design of products using
artificial intelligence; design services;
development of new technology in the fields of
machine learning, artificial intelligence and
robotics; product design using artificial
intelligence; product quality evaluation;
providing computer software that may be
downloaded from a global computer network;
quality control; research and consultancy
services relating to artificial intelligence;
research and development services; scientific
and technical research, namely, scientific and
product research in the fields of artificial
intelligence (AI), machine learning and deep
learning; scientific research and development
in the fields of machine learning, artificial
intelligence and robotics; scientific research
consulting in the fields of machine learning,
artificial intelligence and robotics; software
design and development in the fields of
augmented reality, artificial intelligence,
machine learning, and the internet of things;
technical project studies; technical research;
technological advisory services relating to
machine engineering analysis; analysis of
product design; Application service provider
(ASP); provision of artificial intelligence
software for design; provision of artificial

intelligence software for manufacturing; automotive design; cloud computing; computer aided design services; database design; design and development of computer software for use with augmented reality (AR); design and development of software; design of commercial products; design of communications apparatus; design of computer codes; design of computer database; design of computer languages; design of new products; development of computer software application solutions; evaluation of product design; product design; product development consultancy for inventors in the field of robotics; product research and development; professional consultancy relating to the science of ergonomics; Quality testing; research and design services; research and design services relating to small scale design robotics; research and development in relation to healthcare products; research and development of new products and technologies; research and development of new products for others; research in the field of artificial intelligence; research in the field of communications technology and computer software; scientific and technological services and research and design services related thereto; scientific research; scientific research and development; software development and research in the field of AI design for autonomous mobility; software development and research in the field of AI enhanced 3D head scanning technology and related products development; software development and research in the field of artificial intelligence and 3D modelling for wellbeing; software development and research in the field of data analytics for product and service design; software development and research in the field of developing an intelligent design system to promote innovation; software development and research in the field of developing personal assistive robots; software development and research in the field of developing personal avatars for well-being; software development and research in the field of machine learning; software development and research in the field of sustainable design by using evolutionary algorithms for eco-innovation; technical data analysis; technological research; testing, analysis and monitoring of system algorithms for generating telecommunications and navigation data; testing, inspection and research services in the fields of manufacturing; visual design; software as a

service [SaaS]; software as a service [SaaS]
featuring computer software platforms for
artificial intelligence.

- [526] 卸棄: N/A
Disclaimer:
- [529] 限制: N/A
Limitation:
- [527] 條件: N/A
Condition:
其他: N/A
Others
- [220] 提交日期: 04-01-2022
Date of Filing:
- [320] 聲稱具有優先權的日期: N/A
Date of Priority Claimed:
- [310] 優先權申請編號: N/A
Priority Application Number:
- [340] 聲稱具有優先權 (部分): N/A
Priority Claim Details:
- [330] 優先權申請的
國家、地區、地方: N/A
Country, territory, area of
Priority Applications:

-
- [210] 商標申請編號: 305849470
Application No.:
- [540] 商標:
Mark:

VizHUB

- [550] 商標種類: Ordinary
Mark Type:
一系列商標: NO
Series Mark:
- [571] 商標描述: N/A
Mark Description:
- [730] 註冊申請人的姓名 / 名稱、地址: Location Ai Technology Limited
Applicant(s) ' Room 2308, 23/F, CEO Tower,
Name,Address: 77 Wing Hong Street, Lai Chi Kok, Kowloon
HONG KONG
- [740/ 註冊申請人的送達地址: WENPING PATENT & TRADE MARK AGENT LIMITED
750] Applicant's Address for 1701 Tung Wai Commercial Building,
Service: 111 Gloucester Road,
HONG KONG

[511] 類別編號 : 9, 42

Class(es) No(s) .:

[511] 貨品 / 服務說明 :

Specification:

Class 42:

Advanced product research in the field of artificial intelligence; application service provider (ASP) services featuring application programming interface (API) software for artificial intelligence (AI), machine learning, deep learning, statistical learning and data mining to enable contextual prediction, personalization, predictive analytics, predictive modeling and business intelligence services; appraising of designs using artificial intelligence; collaborative computer programming; computer programming and software design; data mining; database design and development; design and updating of software for embedded devices and software maintenance services, computer systems analysis; design of computer databases; design of interior décor; design of products using artificial intelligence; design services; development of new technology in the fields of machine learning, artificial intelligence and robotics; product design using artificial intelligence; product quality evaluation; providing computer software that may be downloaded from a global computer network; quality control; research and consultancy services relating to artificial intelligence; research and development services; scientific and technical research, namely, scientific and product research in the fields of artificial intelligence (AI), machine learning and deep learning; scientific research and development in the fields of machine learning, artificial intelligence and robotics; scientific research consulting in the fields of machine learning, artificial intelligence and robotics; software design and development in the fields of augmented reality, artificial intelligence, machine learning, and the internet of things; technical project studies; technical research; technological advisory services relating to machine engineering analysis; analysis of product design; Application service provider (ASP); provision of artificial intelligence software for design; provision of artificial intelligence software for manufacturing; automotive design; cloud computing; computer aided design services; database design; design and development of computer software for use with augmented reality (AR); design and development of software; design of commercial products; design of communications apparatus; design of computer codes; design of computer

database; design of computer languages; design of new products; development of computer software application solutions; evaluation of product design; product design; product development consultancy for inventors in the field of robotics; product research and development; professional consultancy relating to the science of ergonomics; Quality testing; research and design services; research and design services relating to small scale design robotics; research and development in relation to healthcare products; research and development of new products and technologies; research and development of new products for others; research in the field of artificial intelligence; research in the field of communications technology and computer software; scientific and technological services and research and design services related thereto; scientific research; scientific research and development; software development and research in the field of AI design for autonomous mobility; software development and research in the field of AI enhanced 3D head scanning technology and related products development; software development and research in the field of artificial intelligence and 3D modelling for wellbeing; software development and research in the field of data analytics for product and service design; software development and research in the field of developing an intelligent design system to promote innovation; software development and research in the field of developing personal assistive robots; software development and research in the field of developing personal avatars for well-being; software development and research in the field of machine learning; software development and research in the field of sustainable design by using evolutionary algorithms for eco-innovation; technical data analysis; technological research; testing, analysis and monitoring of system algorithms for generating telecommunications and navigation data; testing, inspection and research services in the fields of manufacturing; visual design; software as a service [SaaS]; software as a service [SaaS] featuring computer software platforms for artificial intelligence.

- [526] 卸棄 : N/A
Disclaimer:
- [529] 限制 : N/A
Limitation:

[527]	條件 :	N/A
	Condition:	
	其他 :	N/A
	Others	
[220]	提交日期 :	04-01-2022
	Date of Filing:	
[320]	聲稱具有優先權的日期 :	N/A
	Date of Priority Claimed:	
[310]	優先權申請編號 :	N/A
	Priority Application Number:	
[340]	聲稱具有優先權 (部分) :	N/A
	Priority Claim Details:	
[330]	優先權申請的 國家、地區、地方 :	N/A
	Country, territory, area of Priority Applications:	
<hr/>		
[210]	商標申請編號 :	305849489
	Application No.:	
[540]	商標 :	
	Mark:	<h1>GeoLOCK</h1>
[550]	商標種類 :	Ordinary
	Mark Type:	
	一系列商標 :	NO
	Series Mark:	
[571]	商標描述 :	N/A
	Mark Description:	
[730]	註冊申請人的姓名 / 名稱、地址 :	Location Ai Technology Limited Room 2308, 23/F, CEO Tower, 77 Wing Hong Street, Lai Chi Kok, Kowloon HONG KONG
	Applicant(s)' Name, Address:	
[740/	註冊申請人的送達地址 :	WENPING PATENT & TRADE MARK AGENT LIMITED 1701 Tung Wai Commercial Building, 111 Gloucester Road, HONG KONG
750]	Applicant's Address for Service:	
[511]	類別編號 :	9, 42
	Class(es) No(s) .:	
[511]	貨品 / 服務說明 :	Class 42:
	Specification:	Advanced product research in the field of artificial intelligence; application service provider (ASP) services featuring application programming interface (API) software for artificial intelligence (AI), machine learning, deep learning, statistical learning and data mining to enable contextual prediction, personalization, predictive

analytics, predictive modeling and business intelligence services; appraising of designs using artificial intelligence; collaborative computer programming; computer programming and software design; data mining; database design and development; design and updating of software for embedded devices and software maintenance services, computer systems analysis; design of computer databases; design of interior décor; design of products using artificial intelligence; design services; development of new technology in the fields of machine learning, artificial intelligence and robotics; product design using artificial intelligence; product quality evaluation; providing computer software that may be downloaded from a global computer network; quality control; research and consultancy services relating to artificial intelligence; research and development services; scientific and technical research, namely, scientific and product research in the fields of artificial intelligence (AI), machine learning and deep learning; scientific research and development in the fields of machine learning, artificial intelligence and robotics; scientific research consulting in the fields of machine learning, artificial intelligence and robotics; software design and development in the fields of augmented reality, artificial intelligence, machine learning, and the internet of things; technical project studies; technical research; technological advisory services relating to machine engineering analysis; analysis of product design; Application service provider (ASP); provision of artificial intelligence software for design; provision of artificial intelligence software for manufacturing; automotive design; cloud computing; computer aided design services; database design; design and development of computer software for use with augmented reality (AR); design and development of software; design of commercial products; design of communications apparatus; design of computer codes; design of computer database; design of computer languages; design of new products; development of computer software application solutions; evaluation of product design; product design; product development consultancy for inventors in the field of robotics; product research and development; professional consultancy relating to the science of ergonomics; Quality testing; research and design services; research and design services relating to small scale design robotics; research and development in relation

to healthcare products; research and development of new products and technologies; research and development of new products for others; research in the field of artificial intelligence; research in the field of communications technology and computer software; scientific and technological services and research and design services related thereto; scientific research; scientific research and development; software development and research in the field of AI design for autonomous mobility; software development and research in the field of AI enhanced 3D head scanning technology and related products development; software development and research in the field of artificial intelligence and 3D modelling for wellbeing; software development and research in the field of data analytics for product and service design; software development and research in the field of developing an intelligent design system to promote innovation; software development and research in the field of developing personal assistive robots; software development and research in the field of developing personal avatars for well-being; software development and research in the field of machine learning; software development and research in the field of sustainable design by using evolutionary algorithms for eco-innovation; technical data analysis; technological research; testing, analysis and monitoring of system algorithms for generating telecommunications and navigation data; testing, inspection and research services in the fields of manufacturing; visual design; software as a service [SaaS]; software as a service [SaaS] featuring computer software platforms for artificial intelligence.

- [526] 卸棄 : N/A
Disclaimer:
- [529] 限制 : N/A
Limitation:
- [527] 條件 : N/A
Condition:
- 其他 : N/A
Others
- [220] 提交日期 : 04-01-2022
Date of Filing:
- [320] 聲稱具有優先權的日期 : N/A
Date of Priority Claimed:
- [310] 優先權申請編號 : N/A
Priority Application Number:

[340] 聲稱具有優先權 (部分): N/A
Priority Claim Details:

[330] 優先權申請的 N/A
國家、地區、地方:
Country, territory, area of
Priority Applications:

[210] 商標申請編號: 305850162
Application No.:

[540] 商標: A
Mark:



B



C



D



[550] 商標種類: Ordinary
Mark Type:

一系列商標: YES

Series Mark:

[571] 商標描述: N/A

Mark Description:

[730] 註冊申請人的姓名 / 名稱、地址:
Applicant(s)'
Name, Address:

Lei Shing Hong Limited
8th Floor, New World Tower I,
18 Queen's Road Central,
HONG KONG

[740/ 註冊申請人的送達地址:

MARKS & CLERK

750] Applicant's Address for
Service:

Level 9, Cyberport 1
100 Cyberport Road, Pok Fu Lam
HONG KONG

[511] 類別編號:
Class(es) No(s) .:

7, 12, 19, 27, 31, 35, 36, 37, 39, 40, 41, 42

[511] 貨品 / 服務說明 : Specification:	Class 42: Vehicle testing services; vehicle emission testing services; testing services relating to machines, generators, heavy machinery and engines; emission testing services relating to machines, generators, heavy machinery and engines; vehicle roadworthiness testing; engineering services; engineering consultancy; industrial analysis services; information, advisory and consultancy services relating to all the aforesaid services.
[526] 卸棄 : Disclaimer:	N/A
[529] 限制 : Limitation:	N/A
[527] 條件 : Condition: 其他 : Others	N/A N/A
[220] 提交日期 : Date of Filing:	05-01-2022
[320] 聲稱具有優先權的日期 : Date of Priority Claimed:	N/A
[310] 優先權申請編號 : Priority Application Number:	N/A
[340] 聲稱具有優先權 (部分) : Priority Claim Details:	N/A
[330] 優先權申請的 國家、地區、地方 : Country, territory, area of Priority Applications:	N/A

[210] 商標申請編號 : 305850469
Application No.:

[540] 商標 : A
Mark:

智省寶

B

智省宝

[550] 商標種類 : Ordinary
Mark Type:

- 一系列商標 : YES
Series Mark:
- [571] 商標描述 : The applicant claims the color black as an element of marks "A" and "B" in the series.
Mark Description:
- [730] 註冊申請人的姓名 / 名稱、地址 : Glory Time Enterprises Limited
Applicant(s) ' Vistra Corporate Services Centre
Name, Address: Wickhams Cay II, Road Town, Tortola
British Virgin Islands VG1110
- [740/ 註冊申請人的送達地址 : Chow Yuen Mei
750] Applicant's Address for Suite 2810, 28/F, Wu Chung House,
Service: 213 Queen's Road East, Wan Chai
HONG KONG
- [511] 類別編號 : 9,42
Class(es) No(s) .:
- [511] 貨品 / 服務說明 : Class 42:
Specification: Design and development of computer software
- [526] 卸棄 : N/A
Disclaimer:
- [529] 限制 : N/A
Limitation:
- [527] 條件 : N/A
Condition:
其他 : N/A
Others
- [220] 提交日期 : 05-01-2022
Date of Filing:
- [320] 聲稱具有優先權的日期 : N/A
Date of Priority Claimed:
- [310] 優先權申請編號 : N/A
Priority Application Number:
- [340] 聲稱具有優先權 (部分) : N/A
Priority Claim Details:
- [330] 優先權申請的 N/A
國家、地區、地方 :
Country, territory, area of
Priority Applications:

-
- [210] 商標申請編號 : 305850612
Application No.:
- [540] 商標 :
Mark:

LÜRSEN
乐顺游艇

- [550] 商標種類 : Ordinary
Mark Type:

一系列商標 : NO
Series Mark:

[571] 商標描述 : N/A
Mark Description:

[730] 註冊申請人的姓名 / 名稱、地址 : FR.LUERSSEN WERFT GMBH & CO.KG
Applicant(s) ' ZUM ALTEN
Name,Address: SPEICHER 11 28759 BREMEN,
GERMANY

[740/ 註冊申請人的送達地址 : UNITALEN ATTORNEYS AT LAW LIMITED
750] Applicant's Address for RM 1201, 12/F, GOLDEN ERA PLAZA,
Service: 39-55 SAI YEE ST, MONGKOK KLN,
HONG KONG

[511] 類別編號 : 12,37,41,42
Class(es) No(s) .:

[511] 貨品 / 服務說明 : Class 42:
Specification: Engineering measurement; civil engineering
drawing.

[526] 卸棄 : N/A
Disclaimer:

[529] 限制 : N/A
Limitation:

[527] 條件 : N/A
Condition:
其他 : N/A
Others

[220] 提交日期 : 05-01-2022
Date of Filing:

[320] 聲稱具有優先權的日期 : N/A
Date of Priority Claimed:

[310] 優先權申請編號 : N/A
Priority Application Number:

[340] 聲稱具有優先權 (部分) : N/A
Priority Claim Details:

[330] 優先權申請的 N/A
國家、地區、地方 :
Country, territory, area of
Priority Applications:

[210] 商標申請編號 : 305850784
Application No.:

[540] 商標：
Mark:

LONGPORT

[550] 商標種類： 一般商標
Mark Type:
一系列商標： 否
Series Mark:

[571] 商標描述： 不適用
Mark Description:

[730] 註冊申請人的姓名 / 名稱、地址： 長橋有限公司 (LONG BRIDGE PTE. LTD.)
Applicant(s) ' 新加坡
Name, Address: 安森路 79 號
#23-01

[740/ 註冊申請人的送達地址： 香港凱旋知識產權代理有限公司
750] Applicant's Address for 香港
Service: 九龍旺角煙廠街 9 號
興發商業大廈 7 樓 703 室

[511] 類別編號： 9, 35, 36, 38, 42
Class(es) No(s) .:

[511] 貨品 / 服務說明： 類別 42：
Specification: 多媒體產品的設計和開發；軟件設計；軟件的開發；計算機編
程；計算機軟件設計；信息技術諮詢服務；平面美術設計；軟
件即服務 (SaaS)；雲計算；平臺即服務 (PaaS)。

[526] 卸棄： 不適用
Disclaimer:

[529] 限制： 不適用
Limitation:

[527] 條件： 不適用
Condition:
其他： 不適用
Others

[220] 提交日期： 05-01-2022
Date of Filing:

[320] 聲稱具有優先權的日期： 不適用
Date of Priority Claimed:

[310] 優先權申請編號： 不適用
Priority Application Number:

[340] 聲稱具有優先權 (部分)： 不適用
Priority Claim Details:

[330] 優先權申請的 不適用
國家、地區、地方：
Country, territory, area of
Priority Applications:

[210] 商標申請編號 : 305850793
Application No.:

[540] 商標 :
Mark:



[550] 商標種類 : 一般商標
Mark Type:
一系列商標 : 否
Series Mark:

[571] 商標描述 : 申請人聲稱黑色、黃色、藍色及紅色為商標的多於一個要素。
Mark Description:

[730] 註冊申請人的姓名 / 名稱、地址 : 長橋有限公司 (LONG BRIDGE PTE. LTD.)
Applicant(s) ' 新加坡
Name, Address: 安森路 79 號

[740/ 註冊申請人的送達地址 : 香港凱旋知識產權代理有限公司
750] Applicant's Address for 香港
Service: 九龍旺角煙廠街 9 號

興發商業大廈 7 樓 703 室

[511] 類別編號 : 9, 35, 36, 38, 42
Class(es) No(s) .:

[511] 貨品 / 服務說明 : 類別 42:
Specification: 多媒體產品的設計和開發; 軟件設計; 軟件的開發; 計算機編程; 計算機軟件設計; 信息技術諮詢服務; 平面美術設計; 軟件即服務 (SaaS); 雲計算; 平臺即服務 (PaaS)。

[526] 卸棄 : 不適用
Disclaimer:

[529] 限制 : 不適用
Limitation:

[527] 條件 : 不適用
Condition:

其他 : 不適用
Others

[220] 提交日期 : 05-01-2022
Date of Filing:

[320] 聲稱具有優先權的日期 : 不適用
Date of Priority Claimed:

[310] 優先權申請編號 : 不適用
Priority Application Number:

[340] 聲稱具有優先權 (部分) : 不適用

Priority Claim Details:

[330] 優先權申請的 不適用
國家、地區、地方：
Country, territory, area of
Priority Applications:

[210] 商標申請編號： 305851288
Application No.:

[540] 商標：
Mark:



[550] 商標種類： 一般商標
Mark Type:
一系列商標： 否
Series Mark:

[571] 商標描述： 不適用
Mark Description:

[730] 註冊申請人的姓名 / 名稱、地址： 上海雲軸信息科技有限公司
Applicant(s) ' 中國
Name, Address: 上海市閔行區

東川路 555 號丁樓 502A 室

[740/ 註冊申請人的送達地址： 香港凱旋知識產權代理有限公司
750] Applicant's Address for 香港

Service: 九龍旺角煙廠街 9 號
興發商業大廈 7 樓 703 室
9, 42

[511] 類別編號： 類別 42:
Class(es) No(s) .: 雲計算；計算機系統設計；計算機軟件維護；計算機軟件更新

[511] 貨品 / 服務說明： 類別 42:
Specification: 雲計算；計算機系統設計；計算機軟件維護；計算機軟件更新
；計算機軟件設計；計算機技術諮詢；計算機軟件諮詢；信息
技術諮詢服務；計算機系統遠程監控；計算機軟件安裝；軟件
設計和開發；計算機編程；計算機軟件出租；計算機病毒的防
護服務；軟件即服務 (SaaS)；遠程數據備份；電子數據存儲
；通過網站提供計算機技術和編程信息；數據安全諮詢；數據
加密服務；平臺即服務 (PaaS)。

[526] 卸棄： 不適用
Disclaimer:

[529] 限制 : 不適用
Limitation:

[527] 條件 : 不適用
Condition:
其他 : 不適用
Others

[220] 提交日期 : 06-01-2022
Date of Filing:

[320] 聲稱具有優先權的日期 : 不適用
Date of Priority Claimed:

[310] 優先權申請編號 : 不適用
Priority Application Number:

[340] 聲稱具有優先權 (部分) : 不適用
Priority Claim Details:

[330] 優先權申請的
國家、地區、地方 : 不適用
Country, territory, area of
Priority Applications:

[210] 商標申請編號 : 305851783
Application No.:

[540] 商標 :
Mark:

A



LifeHikes

B



LifeHikes

[550] 商標種類 : Ordinary
Mark Type:
一系列商標 : YES
Series Mark:

[571] 商標描述 : The applicant claims the colours greenish
Mark Description: blue, sky blue, royal blue and grey as
elements of mark "B" in the series.

[730] 註冊申請人的姓名 / 名稱、地址 : Blue Planet Training, Inc.
Applicant(s) ' 248 Lorraine Avenue, Second Floor,
Name, Address: Montclair, New Jersey 07043,
UNITED STATES OF AMERICA

[740/ 註冊申請人的送達地址 : INCOMPASS IP LIMITED
750] Applicant's Address for Unit 205, 2/F, Building 19W, 19 Science Park
Service: West Avenue,
Hong Kong Science Park, Pak Shek Kok,
HONG KONG

[511] 類別編號 : 9, 41, 42
Class(es) No(s) .:

[511] 貨品 / 服務說明：
Specification:

Class 42:

Application service provider featuring software for training and educational purposes, namely, for use in personal and professional skills assessment, development and learning in the field of business, career, leadership, sales and communication; application service provider featuring software for training and educational purposes, namely, for use in accessing courses and course materials for personal and professional skills development, learning and professional skills assessment in the fields of business, career, leadership, sales and communication; application service provider featuring software for use in meeting and seminar management for training and educational purposes; application service provider featuring software for use in obtaining feedback from learners for training and educational purposes; computer services, namely, providing a website, a computer program or computer program platform to create an on-line community for registered users to participate in discussions for training and educational purposes, namely, interacting with personal and professional skill development coaches all in support of personal and professional learning programs for skill development; software as a service (SAAS) services featuring software for training and educational purposes, namely, personal, and professional development and business strategy development, utilizing artificial intelligence, machine learning, deep learning, statistical learning, supervised learning, unsupervised learning, data mining, predictive analytics, and business intelligence for training and educational purposes; application service provider featuring application programming interface (API) software for training and educational purposes, namely, for personal, and professional development and business strategy development, utilizing artificial intelligence, machine learning, deep learning, statistical learning, supervised learning, unsupervised learning, data mining, predictive analytics, and business intelligence for training and educational purposes; application service provider featuring training and educational software for managing, tracking, and displaying progress of training and education programs for individuals and companies; application service provider featuring training and educational software for personal

and professional skill development coaching utilizing artificial intelligence in support of personal and professional learning programs for skill development; application service provider featuring training and educational software for providing user-specific recommendations for training courses, training materials, and training regimens for personal and professional learning programs for skill development; application service provider featuring training and educational software for providing user exercises for reinforcing personal and professional skill development learning programs.

- [526] 卸棄 : N/A
Disclaimer:
- [529] 限制 : N/A
Limitation:
- [527] 條件 : N/A
Condition:
其他 : N/A
Others
- [220] 提交日期 : 06-01-2022
Date of Filing:
- [320] 聲稱具有優先權的日期 : N/A
Date of Priority Claimed:
- [310] 優先權申請編號 : N/A
Priority Application Number:
- [340] 聲稱具有優先權 (部分) : N/A
Priority Claim Details:
- [330] 優先權申請的
國家、地區、地方 : N/A
Country, territory, area of
Priority Applications:

-
- [210] 商標申請編號 : 305852395
Application No.:

- [540] 商標 :
Mark:

BITSKI

- [550] 商標種類 : Ordinary
Mark Type:
一系列商標 : NO
Series Mark:
- [571] 商標描述 : N/A
Mark Description:

[730] 註冊申請人的姓名 / 名稱、地址 : Bitski, Inc.
Applicant(s)' 77 Van Ness Avenue, Suite 101
Name, Address: San Francisco, CA 94102
UNITED STATES OF AMERICA

[740/ 註冊申請人的送達地址 :
750] Applicant's Address for ONC LAWYERS
Service: 19TH FLOOR, THREE EXCHANGE SQUARE,
8 CONNAUGHT PLACE, CENTRAL,
HONG KONG

[511] 類別編號 : 9, 41, 42
Class(es) No(s) .:

[511] 貨品 / 服務說明 :
Specification: Class 42:
Providing Software as a Service (SaaS),
Platform as a Service (PaaS), and non-
downloadable software; Providing temporary use
of on-line non-downloadable software
development tools; Software as a Service
(SaaS) services featuring software for
creating, selling, buying, trading, owning,
storing, and managing non-fungible tokens
(NFTs), digital media, digital goods, and
data; Platform as a Service (PaaS) services
featuring software for creating, selling,
buying, trading, owning, storing, and managing
non-fungible tokens (NFTs), digital media,
digital goods, and data; Providing temporary
use of on-line non-downloadable computer
software for use as an electronic wallet and
digital wallet; Software as a Service (SaaS)
services featuring computer software for
application and database integration; Platform
as a Service (PaaS) services featuring
computer software for application and database
integration; Providing non-downloadable
computer software for managing and verifying
non-fungible tokens (NFTs), digital media and
digital goods transactions using blockchain
technology; Providing non-downloadable
software for blockchain-based inventory
management; Providing non-downloadable
software for compiling indexes of information
using blockchain technology; Authentication
and verification of data in the fields of
works of art, non-fungible tokens (NFTs), and
digital media, using blockchain technology;
Authenticating works of art; Electronic data
storage; Electronic storage of electronic
media, namely, images, graphics, text, video
and audio data; Providing non-downloadable
software for an online marketplace for buyers
and sellers of goods; Providing a website that
features information on non-fungible tokens
(NFTs), digital media, and works of art;
Providing a website featuring non-downloadable
software which features technology that
enables users to transfer and receive
financial payments.

[526] 卸棄: N/A
Disclaimer:

[529] 限制: N/A
Limitation:

[527] 條件: N/A
Condition:
其他: N/A
Others

[220] 提交日期: 07-01-2022
Date of Filing:

[320] 聲稱具有優先權的日期: 10-07-2021
Date of Priority Claimed:

[310] 優先權申請編號: 90821251
Priority Application Number:

[340] 聲稱具有優先權 (部分): N/A
Priority Claim Details:

[330] 優先權申請的
國家、地區、地方: UNITED STATES OF AMERICA
Country, territory, area of
Priority Applications:

[210] 商標申請編號: 305852458
Application No.:

[540] 商標: A
Mark:



B



[550] 商標種類 :	Ordinary
Mark Type:	
一系列商標 :	YES
Series Mark:	
[571] 商標描述 :	The applicant claims the colours red and yellow as elements of Mark "B" in the series.
Mark Description:	
[730] 註冊申請人的姓名 / 名稱、地址 :	Supreme Property Management Limited
Applicant(s) ' Name,Address:	Unit 26, 2/F, Block A, Hoi Luen Industrial Centre, 55 Hoi Yuen Road, Kwun Tong, HONG KONG
[740/ 註冊申請人的送達地址 :	RIGHT IP LIMITED
750] Applicant's Address for Service:	2002 Jupiter Tower 9 Jupiter Street HONG KONG
[511] 類別編號 :	16, 35, 36, 37, 41, 42
Class(es) No(s) .:	
[511] 貨品 / 服務說明 :	Class 42:
Specification:	Construction drafting; design and development of computer hardware and software; design of interior layout of the premises; industrial analysis; industrial design; industrial research; interior design; quality control and authentication services; scientific and technological services and research and design relating thereto; surveying and land surveying; provision of information, advisory and consultancy services relating to the aforesaid services.
[526] 卸棄 :	N/A
Disclaimer:	
[529] 限制 :	N/A
Limitation:	
[527] 條件 :	N/A
Condition:	
其他 :	N/A
Others	
[220] 提交日期 :	07-01-2022
Date of Filing:	
[320] 聲稱具有優先權的日期 :	N/A

Date of Priority Claimed:

[310] 優先權申請編號: N/A

Priority Application Number:

[340] 聲稱具有優先權 (部分): N/A

Priority Claim Details:

[330] 優先權申請的 N/A

國家、地區、地方:

Country, territory, area of

Priority Applications:

[210] 商標申請編號: 305852502

Application No.:

[540] 商標: A

Mark:



B



[550] 商標種類: 一般商標

Mark Type:

一系列商標: 是

Series Mark:

[571] 商標描述 : Mark Description:	在本系列商標中的商標"A", 申請人聲稱綠色、藍色和黑色為商標的多於一個要素。
[730] 註冊申請人的姓名 / 名稱、地址 : Applicant(s) ' Name, Address:	百望股份有限公司 中國 北京市海澱區 北清路 81 號一區 1 號樓 14 層 15 層
[740/ 註冊申請人的送達地址 : 750] Applicant's Address for Service:	黃嘉錫律師事務所 香港 金鐘金鐘道 89 號 力寶中心二期 35 樓 3510 室
[511] 類別編號 : Class(es) No(s) .:	9, 35, 36, 38, 42
[511] 貨品 / 服務說明 : Specification:	類別 42: 計算機編程; 計算機軟件設計; 計算機系統設計; 把有形的數據或文件轉換成電子媒體; 計算機程序和數據的數據轉換 (非有形轉換); 替他人創建和維護網站; 提供互聯網搜索引擎; 文檔數字化 (掃描); 平台即服務 (PaaS); 軟件運營服務 (SaaS); 技術研究; 大數據儲存及分析 (電腦服務); 大數據應用及大數據信息解決方案範疇的顧問及科技服務; 電子數據存儲; 雲計算服務; 人工智能運算。
[526] 卸棄 : Disclaimer:	不適用
[529] 限制 : Limitation:	不適用
[527] 條件 : Condition:	不適用
其他 : Others	不適用
[220] 提交日期 : Date of Filing:	07-01-2022
[320] 聲稱具有優先權的日期 : Date of Priority Claimed:	不適用
[310] 優先權申請編號 : Priority Application Number:	不適用
[340] 聲稱具有優先權 (部分) : Priority Claim Details:	不適用
[330] 優先權申請的 國家、地區、地方 : Country, territory, area of Priority Applications:	不適用

[210] 商標申請編號 : Application No.:	305852737
------------------------------------	-----------

[540] 商標 :
Mark:

JMsolution

[550] 商標種類 : Ordinary
Mark Type:
一系列商標 : NO
Series Mark:

[571] 商標描述 : N/A
Mark Description:

[730] 註冊申請人的姓名 / 名稱、地址 : GP CLUB CO., LTD.
Applicant(s) ' 1222-12F CHANGGANG BD,
Name,Address: 86, MAPO-DAERO, MAPO-GU, SEOUL
REPUBLIC OF KOREA

[740/ 註冊申請人的送達地址 : HONG KONG VICTORY INTELLECTUAL PROPERTY AGENT
750] Applicant's Address for CO., LIMITED
Service: RM 703,7/F PROSPER COMM BLDG,
9 YIN CHONG ST, MONGKOK, KLN,
HONG KONG

[511] 類別編號 : 8,16,18,20,24,31,42,44
Class(es) No(s) .:

[511] 貨品 / 服務說明 : Class 42:
Specification: Technological research; Cosmetic research;
Biological research; Cosmetics testing
services; Packaging design; Interior design;
Dress designing; Cloud computing;
Authenticating works of art; Graphic design;
Geological surveys; Meteorological
information.

[526] 卸棄 : N/A
Disclaimer:

[529] 限制 : N/A
Limitation:

[527] 條件 : N/A
Condition:
其他 : N/A
Others

[220] 提交日期 : 07-01-2022
Date of Filing:

[320] 聲稱具有優先權的日期 : N/A
Date of Priority Claimed:

[310] 優先權申請編號 : N/A

Priority Application Number:

[340] 聲稱具有優先權 (部分): N/A

Priority Claim Details:

[330] 優先權申請的 N/A

國家、地區、地方:

Country, territory, area of

Priority Applications:

[210] 商標申請編號: 305852773

Application No.:

[540] 商標:

Mark:

A



B



[550] 商標種類: 一般商標

Mark Type:

一系列商標:

是

Series Mark:

[571] 商標描述:

Mark Description:

在本系列商標中的商標"A", 申請人聲稱橘黃色及深藍色為商標的多於一個要素。

[730] 註冊申請人的姓名 / 名稱、地址:

Applicant(s)'

Name, Address:

HONG KONG PRESSPLAY LIMITED

香港

九龍尖沙咀科學館道 1 號

康宏廣場 25 樓 9 室

[740/ 註冊申請人的送達地址:

750] Applicant's Address for

Service:

HONG KONG PRESSPLAY LIMITED

香港

九龍尖沙咀科學館道 1 號

康宏廣場 25 樓 9 室

[511] 類別編號:

Class(es) No(s).:

9, 35, 38, 41, 42

[511] 貨品 / 服務說明:

Specification:

類別 42:

提供線上不可下載電腦軟體之暫時使用服務; 軟體即服務 (SaaS); 全部包括於類別 42。

[526] 卸棄:

Disclaimer:

不適用

[529] 限制:

Limitation:

不適用

[527] 條件:

Condition:

不適用

其他:

Others

不適用

[220] 提交日期:

Date of Filing:

07-01-2022

[320] 聲稱具有優先權的日期 : 不適用
Date of Priority Claimed:

[310] 優先權申請編號 : 不適用
Priority Application Number:

[340] 聲稱具有優先權 (部分) : 不適用
Priority Claim Details:

[330] 優先權申請的
國家、地區、地方 : 不適用
Country, territory, area of
Priority Applications:

[210] 商標申請編號 : 305852791
Application No.:

[540] 商標 :
Mark:



[550] 商標種類 : Ordinary
Mark Type:

一系列商標 : YES
Series Mark:

[571] 商標描述 : The applicant claims the colours blue, red,
Mark Description: green, brown and purple as elements of mark
"B" in the series

[730] 註冊申請人的姓名 / 名稱、地址 : KYWH LIMITED
Applicant(s) ' Rm 831, 8/F, Sino Industrial Plaza
Name,Address: 9 Kai Cheung Road, Kowloon Bay
HONG KONG

[740/ 註冊申請人的送達地址 : KYWH LIMITED
750] Applicant's Address for Rm 831, 8/F, Sino Industrial Plaza
Service: 9 Kai Cheung Road, Kowloon Bay
HONG KONG

[511] 類別編號 : 9,28,42
Class(es) No(s) .:

[511] 貨品 / 服務說明 : Class 42:
Specification: software as a service (SaaS), platform as a
service (PaaS), computer programming;
designing, maintenance, testing and analysis

of computer software, computer system and computer programs; computer hardware and software leasing; updating of computer software; providing computer stations, recovery of computer data; design of web sites and software applications on global computer networks and local and internal business computer networks; graphic art design and development of multimedia software applications; monitoring of computer systems and computer networks of others, integration of computer database systems; design research and development in the field of telecommunication and broadcasting; provision of information in the forms of publications, magazines, magazines supplements, magazine sections, newsletters, pamphlets, brochures, exhibition programs, reports, books and directories, provided on-line from a computer data base or from the Internet; dress and fashion designing; provision of information, management, consultancy and advisory services relating to all the aforesaid services; all included in Class 42.

- [526] 卸棄 : N/A
Disclaimer:
- [529] 限制 : N/A
Limitation:
- [527] 條件 : N/A
Condition:
其他 : N/A
Others
- [220] 提交日期 : 07-01-2022
Date of Filing:
- [320] 聲稱具有優先權的日期 : N/A
Date of Priority Claimed:
- [310] 優先權申請編號 : N/A
Priority Application Number:
- [340] 聲稱具有優先權 (部分) : N/A
Priority Claim Details:
- [330] 優先權申請的 : N/A
國家、地區、地方 :
Country, territory, area of
Priority Applications:
-
-

- [210] 商標申請編號 : 305853178
Application No.:

[540] 商標 :
Mark:



[550] 商標種類 : Ordinary
Mark Type:
一系列商標 : NO
Series Mark:

[571] 商標描述 : N/A
Mark Description:

[730] 註冊申請人的姓名 / 名稱、地址 : FULIAO HONG KONG LIMITED
Applicant(s) ' SUITE 603 6/F LAWS COMM PLAZA
Name,Address: 788 CHEUNG SHA WAN RD KL
HONG KONG

[740/ 註冊申請人的送達地址 : INTERMARK PATENTES Y MARCAS, S.L.P. LIMITED
750] Applicant's Address for ROOM F 6/F MEGA CUBE
Service: NO.8 WANG KWONG ROAD KOWLOON
HONG KONG

[511] 類別編號 : 42
Class(es) No(s) .:

[511] 貨品 / 服務說明 : Class 42:
Specification: Research and development of new products for
others;computer software design;updating of
computer software;computer
programming;creating and maintaining websites
for others;installation of computer
software;electronic data storage;rental of
computer software;providing search engines for
the Internet;data encryption services

[526] 卸棄 : N/A
Disclaimer:

[529] 限制 : N/A
Limitation:

[527] 條件 : N/A
Condition:
其他 : N/A
Others

[220] 提交日期 : 07-01-2022
Date of Filing:

[320] 聲稱具有優先權的日期 : N/A
Date of Priority Claimed:

[310] 優先權申請編號 : N/A
Priority Application Number:

[340] 聲稱具有優先權 (部分) : N/A
Priority Claim Details:

[330] 優先權申請的 N/A
國家、地區、地方：
Country, territory, area of
Priority Applications:

[210] 商標申請編號： 305853862
Application No.:

[540] 商標： A
Mark:

嘉爾特

B

嘉尔特

[550] 商標種類： Ordinary

Mark Type:

一系列商標：

YES

Series Mark:

[571] 商標描述： N/A

Mark Description:

[730] 註冊申請人的姓名 / 名稱、地址：

Applicant(s) ' Name, Address:

BALLET QUARTER HOLDINGS PTE. LTD.

6 BATTERY ROAD,

#42-00 SINGAPORE 049909

SINGAPORE

[740/ 註冊申請人的送達地址：

750] Applicant's Address for
Service:

KAIZEN IP AGENT LIMITED

Rooms 2103, Futura Plaza,

111 How Ming Street, Kwun Tong

HONG KONG

[511] 類別編號：

Class(es) No(s) .:

9, 15, 16, 25, 28, 35, 38, 41, 42

[511] 貨品 / 服務說明：

Specification:

Class 42:

Computer co-location services; Computer programming; Computer security consultancy; Constructing an internet platform for electronic commerce; Conversion of document data from one computer format to another; Creation of internet web sites; Customization of computer software; Design and development of computer hardware and software; Design of communication systems; Design of corporate identity; Design of products; Design services; Development of computer software; Graphic arts design; Hosting computer sites [web sites]; Hosting of software as a service [SaaS]; Information technology services provided on an

outsourcing basis; Installation of computer software; Interior design services; Maintenance of computer software; Monitoring of computer systems by remote access; Monitoring of computer systems to detect breakdowns; Online data storage; Packaging design; Providing virtual computer environments through cloud computing; Remote server administration; Rental of computer hardware; Rental of computer software; Research and development of new products for others; Research in the field of telecommunications technology.

- [526] 卸棄 : N/A
Disclaimer:
- [529] 限制 : N/A
Limitation:
- [527] 條件 : N/A
Condition:
其他 : N/A
Others
- [220] 提交日期 : 10-01-2022
Date of Filing:
- [320] 聲稱具有優先權的日期 : N/A
Date of Priority Claimed:
- [310] 優先權申請編號 : N/A
Priority Application Number:
- [340] 聲稱具有優先權 (部分) : N/A
Priority Claim Details:
- [330] 優先權申請的
國家、地區、地方 : N/A
Country, territory, area of
Priority Applications:

-
- [210] 商標申請編號 : 305854168
Application No.:

- [540] 商標 : A
Mark:

FFRONTEE

B
Ffrontee

C

ffrontee

- [550] 商標種類: Ordinary
Mark Type:
一系列商標: YES
Series Mark:
- [571] 商標描述: N/A
Mark Description:
- [730] 註冊申請人的姓名 / 名稱、地址: Alibaba Singapore Holding Private Limited
Applicant(s) ' 8 Shenton Way, #45-01 AXA Tower,
Name,Address: Singapore 068811,
SINGAPORE
- [740/ 註冊申請人的送達地址: ELLALAN
750] Applicant's Address for 26th - 28th Floors, The Hennessy,
Service: 256 Hennessy Road, Wanchai,
Hong Kong
- [511] 類別編號: 9, 35, 42
Class(es) No(s) .:
- [511] 貨品 / 服務說明: Class 42:
Specification: Scientific and technological services and research and design relating thereto; industrial analysis and research services; design and development of computer hardware and software; cloud computing; cloud hosting provider services; providing temporary use of non-downloadable cloud-based software and cloud computing software; providing virtual computer systems and virtual computer environments through cloud computing; software as a service (SaaS); computer services in connection with transmitting information, data, documents, and images over the Internet; computer services in connection with providing an online access to interactive computer database featuring movies programming, previews, trailers, sports, concerts, celebrity and entertainment news and other related information; application service provider (ASP) services, namely, hosting computer software applications of others; application service provider (ASP) services providing software in the fields of web-based conferencing, audio conferencing, electronic messaging, document collaboration, video conferencing, and voice and call processing; providing online non-downloadable software for facilitating the interoperability of multiple software applications; providing a website featuring technology that enables users to share information and advice; computer services, namely, creating an online community for registered users to participate in

discussions, get feedback from their peers, form virtual communities, engage in social networking, and exchange documents; providing on-line non-downloadable computer software and computer applications for streaming audio materials, video materials, videos, music and images; computer service relating to creating indexes of information, sites and resources on computer networks; providing internet search engines; providing software for searching and retrieving information from databases and computer networks; computer services in relation to providing direct connection services between computer users for exchanging data; research and development relating to semi-conductor, semi-conductor integrated circuits, semi-conductor memory chips, semi-conductor memory controllers, semi-conductor memory integrated circuits, semi-conductor processor chips, semi-conductor processors, microcontrollers, microcontroller units, low power microcontrollers, circuit chips, computer chips, CPU (central processing unit), RISC-V (reduced instruction set computer-five) computer chips and central processing units, computer chips and central processing units with instruction set architecture; design of computers, notebook computers, laptop computers, portable computers and handheld computers; design of personal digital assistants and personal media players; design of mobile telephones and smart phones; design of digital cameras; computer services; computer services relating to customized searching of computer databases and websites; computer programming; computer integration services; computer analysis services; computer programming in relation to the defence against virus; computer system software services; computer software design; design, development, updating and upgrading of computer and video games software; computer system design; design and development of webpages; hosting webpages for others; hosting computer application; consultancy services in relation to computer software; computer and electronic signal coding and decoding; conversion of physical data and documents into electronic media format; computer services relating to certification of business transactions and preparation of reports therefor; computer and computer network information services; provision of computer security risk management programs; computer security information, knowledge, and testing services; quality assurance services; computer security services

for access control to computers, electronic networks and databases; security of data transmission and of transactions via computer networks; consultancy in the field of data security; technological consultancy concerning securing telecommunications; computerized communication network security services; providing information in the fields of Internet, world wide web and computerized communication network security; consulting services in the fields of Internet, world wide web and computerized communication network security services, information security services; authentication services for computer security; computer services in relation to online authentication of electronic signatures; off-site data backup; electronic storage of data; providing information on computer technology and programming via a web site; rental of entertainment software; cartography services; technical support (technical consultancy) services relating to computer software and applications provided online, by email and by telephone; computer technology advice provided to Internet users by means of a support hotline; providing technical information at the specific request of end-users by means of telephone or global computer network; technical project studies; product testing and evaluation services; architectural and design services; interior designs of buildings, offices and apartments; consultancy, information and advisory services relating to the aforesaid services; all included in Class 42.

- [526] 卸棄 : N/A
Disclaimer:
- [529] 限制 : N/A
Limitation:
- [527] 條件 : N/A
Condition:
其他 : N/A
Others
- [220] 提交日期 : 10-01-2022
Date of Filing:
- [320] 聲稱具有優先權的日期 : N/A
Date of Priority Claimed:
- [310] 優先權申請編號 : N/A
Priority Application Number:
- [340] 聲稱具有優先權 (部分) : N/A
Priority Claim Details:
- [330] 優先權申請的
國家、地區、地方 : N/A

Country, territory, area of
Priority Applications:

[210] 商標申請編號 : 305854195
Application No.:

[540] 商標 :
Mark: **HYBER TECHNOLOGIES**

[550] 商標種類 : Ordinary
Mark Type:
一系列商標 : NO
Series Mark:

[571] 商標描述 : N/A
Mark Description:

[730] 註冊申請人的姓名 / 名稱、地址 : HYBER TECHNOLOGIES LLC
Applicant(s) ' APT. 15A, 151 EAST 85TH STREET,
Name,Address: NEW YORK, NEW YORK 10028,
UNITED STATES OF AMERICA

[740/ 註冊申請人的送達地址 : SHANGHAI INTELLECTUAL PROPERTY OFFICE
750] Applicant's Address for Unit F, 20th Floor, Neich Tower,
Service: 128 Gloucester Road,
HONG KONG

[511] 類別編號 : 42
Class(es) No(s) .:

[511] 貨品 / 服務說明 : Class 42:
Specification: Providing SAAS (software-as-a-service) in the
field of automating financial transaction
workflow, namely automating trade execution,
customer relationship management, settlement,
and back-office functionalities.

[526] 卸棄 : N/A
Disclaimer:

[529] 限制 : N/A
Limitation:

[527] 條件 : N/A
Condition:
其他 : N/A
Others

[220] 提交日期 : 10-01-2022
Date of Filing:

[320] 聲稱具有優先權的日期 : 14-07-2021
Date of Priority Claimed:

[310] 優先權申請編號 : 90828989
Priority Application Number:

[340] 聲稱具有優先權 (部分) : N/A
Priority Claim Details:

[330] 優先權申請的 UNITED STATES OF AMERICA
國家、地區、地方：
Country, territory, area of
Priority Applications:

[210] 商標申請編號： 305854465
Application No.:

[540] 商標：
Mark:

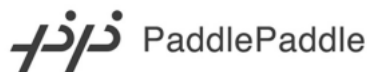

[550] 商標種類： 一般商標
Mark Type:

一系列商標： 否

Series Mark:

[571] 商標描述： 不適用

Mark Description:

[730] 註冊申請人的姓名 / 名稱、地址： 百度在線網絡技術（北京）有限公司
Applicant(s) ' 中國
Name, Address: 北京市海澱區

上地十街 10 號百度大廈

[740/ 註冊申請人的送達地址： 中港知識產權有限公司

750] Applicant's Address for 香港
Service: 灣仔告士打道 151 號
資本中心 15 樓 1502 室

[511] 類別編號： 9, 42

Class(es) No(s) .:

[511] 貨品 / 服務說明： 類別 42:

Specification:

關於用於人工智慧、深度學習、高性能計算、分散式運算、虛擬化和機器學習領域的計算機軟件的设计、開發、更新和諮詢；關於用於實現計算機編程語言、數據轉換、輸入及/或輸出、通訊、圖形顯示、建模和測試的計算機軟件的设计、開發、更新和諮詢；關於計算機軟件庫的創建、維護、更新和諮詢；計算機軟件设计；計算機軟件更新；計算機硬件设计和開發諮詢；替他人創建和維護網站；計算機病毒的防護服務；提供互聯網搜索引擎；軟件即服務（SaaS）；平台即服務（PaaS）；電子數據存儲；通過網站提供計算機技術和編程信息；雲計算；技術研究；技術項目研究；替他人研究和開發新產品；科學研究；質量控制；計算機編程；計算機軟件維護；計算機系統设计；信息技術諮詢服務；軟件出版框架下的軟件開發；計算機安全諮詢。

[526] 卸棄： 不適用

Disclaimer:

[529] 限制： 不適用

Limitation:

[527] 條件 : 不適用
Condition:
其他 : 不適用
Others

[220] 提交日期 : 10-01-2022
Date of Filing:

[320] 聲稱具有優先權的日期 : 不適用
Date of Priority Claimed:

[310] 優先權申請編號 : 不適用
Priority Application Number:

[340] 聲稱具有優先權 (部分) : 不適用
Priority Claim Details:

[330] 優先權申請的
國家、地區、地方 : 不適用
Country, territory, area of
Priority Applications:

[210] 商標申請編號 : 305854636
Application No.:

[540] 商標 :
Mark:

Xtacking

[550] 商標種類 : 一般商標
Mark Type:
一系列商標 : 否
Series Mark:

[571] 商標描述 : 不適用
Mark Description:

[730] 註冊申請人的姓名 / 名稱、地址 : 長江存儲科技有限責任公司
Applicant(s) ' 中國
Name,Address: 湖北省武漢市
東湖新技術開發區未來三路 88 號

[740/ 註冊申請人的送達地址 : 香港派特恩知識產權代理有限公司
750] Applicant's Address for 香港
Service: 上環永樂街 121-125 號
永達商業大廈 10 樓 C 室

[511] 類別編號 : 35,42
Class(es) No(s) .:

[511] 貨品 / 服務說明 : Specification:	類別 42: 集成電路設計; 技術研究; 替他人研究和開發新產品; 技術項目研究; 科學實驗室服務; 科學研究; 材料測試; 信息技術諮詢服務; 撰寫科技文稿; 工業品外觀設計; 藝術品鑒定; 平面美術設計; 電子數據存儲; 服裝設計; 建築製圖; 氣象信息; 臨床試驗; 化學分析; 測量; 產品質量檢測。
[526] 卸棄 : Disclaimer:	不適用
[529] 限制 : Limitation:	不適用
[527] 條件 : Condition: 其他 : Others	不適用
[220] 提交日期 : Date of Filing:	10-01-2022
[320] 聲稱具有優先權的日期 : Date of Priority Claimed:	不適用
[310] 優先權申請編號 : Priority Application Number:	不適用
[340] 聲稱具有優先權 (部分) : Priority Claim Details:	不適用
[330] 優先權申請的 國家、地區、地方 : Country, territory, area of Priority Applications:	不適用

[210] 商標申請編號 : Application No.:	305854645
[540] 商標 : Mark:	

Yangtze Memory

[550] 商標種類 : Mark Type: 一系列商標 : Series Mark:	一般商標 否
[571] 商標描述 : Mark Description:	不適用

- [730] 註冊申請人的姓名 / 名稱、地址 : 長江存儲科技有限責任公司
Applicant(s)' Name, Address: 中國
湖北省武漢市
東湖新技術開發區未來三路 88 號
- [740/ 註冊申請人的送達地址 : 香港派特恩知識產權代理有限公司
750] Applicant's Address for Service: 香港
上環永樂街 121-125 號
永達商業大廈 10 樓 C 室
35, 42
- [511] 類別編號 :
Class(es) No(s) .: 類別 42:
- [511] 貨品 / 服務說明 :
Specification: 集成電路設計 ; 技術研究 ; 替他人研究和開發新產品 ; 技術項目研究 ; 科學實驗室服務 ; 科學研究 ; 材料測試 ; 信息技術諮詢服務 ; 撰寫科技文稿 ; 工業品外觀設計 ; 藝術品鑒定 ; 平面美術設計 ; 電子數據存儲 ; 服裝設計 ; 建築製圖 ; 氣象信息 ; 臨床試驗 ; 化學分析 ; 測量 ; 產品質量檢測。
- [526] 卸棄 : 不適用
Disclaimer:
- [529] 限制 : 不適用
Limitation:
- [527] 條件 : 不適用
Condition:
其他 : 不適用
Others
- [220] 提交日期 : 10-01-2022
Date of Filing:
- [320] 聲稱具有優先權的日期 : 不適用
Date of Priority Claimed:
- [310] 優先權申請編號 : 不適用
Priority Application Number:
- [340] 聲稱具有優先權 (部分) : 不適用
Priority Claim Details:
- [330] 優先權申請的 不適用
國家、地區、地方 :
Country, territory, area of
Priority Applications:
-
-

- [210] 商標申請編號 : 305854654
Application No.:

[540] 商標：
Mark:



[550] 商標種類： 一般商標
Mark Type:
一系列商標： 否
Series Mark:

[571] 商標描述： 不適用
Mark Description:

[730] 註冊申請人的姓名 / 名稱、地址： 長江存儲科技有限責任公司
Applicant(s) ' 中國
Name, Address: 湖北省武漢市
東湖新技術開發區未來三路 88 號

[740/ 註冊申請人的送達地址： 香港派特恩知識產權代理有限公司
750] Applicant's Address for 香港
Service: 上環永樂街 121-125 號
永達商業大廈 10 樓 C 室

[511] 類別編號： 35, 42
Class(es) No(s) .:

[511] 貨品 / 服務說明： 類別 42：
Specification: 集成電路設計；技術研究；替他人研究和開發新產品；技術項目研究；科學實驗室服務；科學研究；材料測試；信息技術諮詢服務；撰寫科技文稿；工業品外觀設計；藝術品鑒定；平面美術設計；電子數據存儲；服裝設計；建築製圖；氣象信息；臨床試驗；化學分析；測量；產品質量檢測。

[526] 卸棄： 不適用
Disclaimer:

[529] 限制： 不適用
Limitation:

[527] 條件： 不適用
Condition:
其他： 不適用
Others

[220] 提交日期： 10-01-2022
Date of Filing:

[320] 聲稱具有優先權的日期： 不適用
Date of Priority Claimed:

[310] 優先權申請編號： 不適用
Priority Application Number:

[340] 聲稱具有優先權 (部分)： 不適用
Priority Claim Details:

[330] 優先權申請的 不適用

國家、地區、地方：

Country, territory, area of
Priority Applications:

[210] 商標申請編號： 305854663
Application No.:

[540] 商標：
Mark:

YMTC

[550] 商標種類： 一般商標
Mark Type:

一系列商標： 否
Series Mark:

[571] 商標描述： 不適用
Mark Description:

[730] 註冊申請人的姓名 / 名稱、地址： 長江存儲科技有限責任公司
Applicant(s) ' 中國
Name, Address: 湖北省武漢市
東湖新技術開發區未來三路 88 號

[740/ 註冊申請人的送達地址： 香港派特恩知識產權代理有限公司
750] Applicant's Address for 香港
Service: 上環永樂街 121-125 號
永達商業大廈 10 樓 C 室

[511] 類別編號： 35, 42
Class(es) No(s) .:

[511] 貨品 / 服務說明： 類別 42：
Specification: 集成電路設計；技術研究；替他人研究和開發新產品；技術項目研究；科學實驗室服務；科學研究；材料測試；信息技術諮詢服務；撰寫科技文稿；工業品外觀設計；藝術品鑒定；平面美術設計；電子數據存儲；服裝設計；建築製圖；氣象信息；臨床試驗；化學分析；測量；產品質量檢測。

[526] 卸棄： 不適用
Disclaimer:

[529] 限制： 不適用
Limitation:

[527] 條件： 不適用
Condition:

其他： 不適用
Others

[220] 提交日期: 10-01-2022
Date of Filing:
[320] 聲稱具有優先權的日期: 不適用
Date of Priority Claimed:
[310] 優先權申請編號: 不適用
Priority Application Number:
[340] 聲稱具有優先權 (部分): 不適用
Priority Claim Details:
[330] 優先權申請的 不適用
國家、地區、地方:
Country, territory, area of
Priority Applications:

[210] 商標申請編號: 305856706
Application No.:
[540] 商標:
Mark:



[550] 商標種類: 一般商標
Mark Type:
一系列商標: 否
Series Mark:
[571] 商標描述: 不適用
Mark Description:
[730] 註冊申請人的姓名 / 名稱、地址: 成都龍淵網路科技有限公司
Applicant(s) ' 中國
Name, Address: 四川自由貿易試驗區
成都高新區益州大道中段 722 號 1 棟 1 單元 12 層 1205 號
卓遠知識產權有限公司
[740/ 註冊申請人的送達地址: 香港
750] Applicant's Address for 上環禧利街 27 號
Service: 富輝商業中心 10 樓
[511] 類別編號: 9, 35, 41, 42
Class(es) No(s) .:

[511] 貨品 / 服務說明 : Specification:	類別 42: 替他人研究和開發新產品; 電信技術諮詢; 計算機軟件設計; 計算機硬件設計和開發諮詢; 計算機軟件維護; 計算機軟件更新; 計算機編程; 計算機程序和數據的數據轉換 (非有形轉換); 軟件即服務 (SaaS) 領域的諮詢服務; 雲計算領域的諮詢服務。
[526] 卸棄 : Disclaimer:	不適用
[529] 限制 : Limitation:	不適用
[527] 條件 : Condition: 其他 : Others	不適用
[220] 提交日期 : Date of Filing:	12-01-2022
[320] 聲稱具有優先權的日期 : Date of Priority Claimed:	不適用
[310] 優先權申請編號 : Priority Application Number:	不適用
[340] 聲稱具有優先權 (部分) : Priority Claim Details:	不適用
[330] 優先權申請的 國家、地區、地方 : Country, territory, area of Priority Applications:	不適用

[210] 商標申請編號 : Application No.:	305856913
[540] 商標 : Mark:	A



B



- [550] 商標種類 : Ordinary
 Mark Type:
 一系列商標 : YES
 Series Mark:
- [571] 商標描述 : N/A
 Mark Description:
- [730] 註冊申請人的姓名 / 名稱、地址 : Lemon Inc.
 Applicant(s) ' P.O. Box 31119 Grand Pavilion, Hibiscus Way,
 Name,Address: 802 West Bay Road, Grand Cayman, KY1 - 1205,
 CAYMAN ISLANDS
- [740/ 註冊申請人的送達地址 : Rouse & Co. International (Overseas) Limited
 750] Applicant's Address for 26/F., Tesbury Centre,
 Service: 28 Queen's Road East
 HONG KONG
- [511] 類別編號 : 9, 35, 38, 41, 42, 45
 Class(es) No(s) .:
- [511] 貨品 / 服務說明 : Class 42:
 Specification: Provision of software applications through a website; hosting on-line web facilities for others for sharing on-line content; hosting platforms on the internet; computer programming; computer software design; development, maintenance and updating of computer software; electronic data storage; software as a service (SaaS) services; cloud computing; hosting a website for the electronic storage of digital photographs and videos; hosting digital content on the internet; hosting multimedia entertainment content; hosting of multimedia and interactive applications; web site hosting services; providing software as a service for use in connection with transmitting, streaming, and downloading music, videos, and audiovisual content; providing temporary use of non-downloadable software for transmitting, streaming, and downloading music, videos, and audiovisual content; application service provider (ASP) services; providing platform on

the Internet for user generated content; platform as a service [PaaS] featuring software platforms for transmission of images, audio-visual content, video content and messages; providing internet application services for communications.

- [526] 卸棄 : N/A
Disclaimer:
- [529] 限制 : N/A
Limitation:
- [527] 條件 : N/A
Condition:
其他 : N/A
Others
- [220] 提交日期 : 12-01-2022
Date of Filing:
- [320] 聲稱具有優先權的日期 : N/A
Date of Priority Claimed:
- [310] 優先權申請編號 : N/A
Priority Application Number:
- [340] 聲稱具有優先權 (部分) : N/A
Priority Claim Details:
- [330] 優先權申請的
國家、地區、地方 : N/A
Country, territory, area of
Priority Applications:

- [210] 商標申請編號 : 305856922
Application No.:

- [540] 商標 :
Mark:



T U n o

- [550] 商標種類 : Ordinary
Mark Type:
一系列商標 : NO
Series Mark:

- [571] 商標描述 : N/A
Mark Description:
- [730] 註冊申請人的姓名 / 名稱、地址 : iTunel Technology Limited
Applicant(s) ' 9 FLOOR, TIMES MEDIA CENTRE,
Name,Address: 133 WANCHAI ROAD, WANCHAI,
HONG KONG
- [740/ 註冊申請人的送達地址 : ACCOLADE IP LIMITED
750] Applicant's Address for 10/F, Fu Fai Comm. Ctr.,
Service: 27 Hillier Street, Sheung Wan,
HONG KONG
- [511] 類別編號 : 9,38,42
Class(es) No(s) .:
- [511] 貨品 / 服務說明 : Class 42:
Specification: providing temporary use of non-downloadable software to enable sharing of multimedia content and comments among users; providing temporary use of on-line non-downloadable operating software for accessing and using a cloud computing network; providing temporary use of on-line non-downloadable software for importing and managing data; provision of online non-downloadable software [application service provider]; Consulting in the field of cloud computing networks and applications; Design and development of software in the field of mobile applications; Development of computer software application solutions; Hosting of computerized data, files. applications and information; Rental of application software; technical consultancy relating to the application and use of computer software; Software as a service [SaaS]; Platform as a service [PaaS]; design and development of wireless data transmission apparatus.
- [526] 卸棄 : N/A
Disclaimer:
- [529] 限制 : N/A
Limitation:
- [527] 條件 : N/A
Condition:
其他 : N/A
Others
- [220] 提交日期 : 12-01-2022
Date of Filing:
- [320] 聲稱具有優先權的日期 : N/A
Date of Priority Claimed:
- [310] 優先權申請編號 : N/A
Priority Application Number:
- [340] 聲稱具有優先權 (部分) : N/A
Priority Claim Details:
- [330] 優先權申請的 國家、地區、地方 : N/A

Country, territory, area of
Priority Applications:

[210] 商標申請編號 : 305856931
Application No.:

[540] 商標 : A
Mark:

TUNO

B

Tuno

[550] 商標種類 : Ordinary
Mark Type:
一系列商標 : YES
Series Mark:

[571] 商標描述 : N/A
Mark Description:

[730] 註冊申請人的姓名 / 名稱、地址 : iTunel Technology Limited
Applicant(s) ' 9 FLOOR, TIMES MEDIA CENTRE,
Name,Address: 133 WANCHAI ROAD, WANCHAI,
HONG KONG

[740/ 註冊申請人的送達地址 : ACCOLADE IP LIMITED
750] Applicant's Address for 10/F, Fu Fai Comm. Ctr.,
Service: 27 Hillier Street, Sheung Wan,
HONG KONG

[511] 類別編號 : 9, 38, 42
Class(es) No(s) .:

[511] 貨品 / 服務說明 : Class 42:
Specification: providing temporary use of non-downloadable software to enable sharing of multimedia content and comments among users; providing temporary use of on-line non-downloadable operating software for accessing and using a cloud computing network; providing temporary use of on-line non-downloadable software for importing and managing data; provision of online non-downloadable software [application service provider]; Consulting in the field of cloud computing networks and applications; Design and development of software in the field of mobile applications; Development of computer software application solutions; Hosting of computerized data, files. applications and information; Rental of application software; technical consultancy

relating to the application and use of computer software; Software as a service [SaaS]; Platform as a service [PaaS]; design and development of wireless data transmission apparatus.

- [526] 卸棄: N/A
Disclaimer:
- [529] 限制: N/A
Limitation:
- [527] 條件: N/A
Condition:
其他: N/A
Others
- [220] 提交日期: 12-01-2022
Date of Filing:
- [320] 聲稱具有優先權的日期: N/A
Date of Priority Claimed:
- [310] 優先權申請編號: N/A
Priority Application Number:
- [340] 聲稱具有優先權 (部分): N/A
Priority Claim Details:
- [330] 優先權申請的
國家、地區、地方: N/A
Country, territory, area of
Priority Applications:

-
- [210] 商標申請編號: 305857011
Application No.:

- [540] 商標:
Mark:

CHUBB JARVIS

- [550] 商標種類: Ordinary
Mark Type:
一系列商標: NO
Series Mark:

- [571] 商標描述: N/A
Mark Description:

- [730] 註冊申請人的姓名 / 名稱、地址: Chubb INA Holdings Inc.
Applicant(s) ' 436 Walnut Street
Name,Address: Philadelphia, PA 19106
UNITED STATES OF AMERICA

- [740/ 註冊申請人的送達地址: SO KEUNG YIP & SIN
750] Applicant's Address for Room 1009-1012, 10/F., Nan Fung Tower,
Service: No. 173 Des Voeux Road Central
HONG KONG

[511] 類別編號 : 42
Class(es) No(s) :
[511] 貨品 / 服務說明 : Class 42:
Specification: Providing online non-downloadable software for
providing recommendations in the field of
insurance.
[526] 卸棄 : N/A
Disclaimer:
[529] 限制 : N/A
Limitation:
[527] 條件 : N/A
Condition:
其他 : N/A
Others
[220] 提交日期 : 13-01-2022
Date of Filing:
[320] 聲稱具有優先權的日期 : N/A
Date of Priority Claimed:
[310] 優先權申請編號 : N/A
Priority Application Number:
[340] 聲稱具有優先權 (部分) : N/A
Priority Claim Details:
[330] 優先權申請的
國家、地區、地方 : N/A
Country, territory, area of
Priority Applications:

[210] 商標申請編號 : 305858876
Application No.:

[540] 商標 :
Mark:

WHEELS UP

[550] 商標種類 : Ordinary
Mark Type:
一系列商標 : NO
Series Mark:

[571] 商標描述 : N/A
Mark Description:

[730] 註冊申請人的姓名 / 名稱、地址 : Wheels Up Partners LLC
Applicant(s) ' 601 West 26th Street Suite 900
Name, Address: New York, New York 10001
UNITED STATES OF AMERICA

[740/ 註冊申請人的送達地址 : CHINA PATENT AGENT (HONG KONG) LIMITED
750] Applicant's Address for 22/F, Great Eagle Centre,
Service: 23 Harbour Road, Wanchai,
HONG KONG

[511]	類別編號 :	9, 25, 35, 39, 42, 43, 45					
	Class(es) No(s) .:						
[511]	貨品/服務說明 :	Class 42:					
	Specification:	Providing temporary use of online non-downloadable software for use in business and operations management for aircraft fleet operators, flight operations management, aircraft maintenance reporting and scheduling, aircraft flight scheduling, aircraft crew scheduling, recordkeeping and safety reporting, aircraft fleet vendor and ground services management, aircraft fleet trip services management, air travel client account management, air travel sales tracking and reporting, scheduling and quoting of aircraft bookings; Software as a service (SaaS) and platform as a service (PaaS) featuring online software for use in business and operations management for aircraft fleet operators; Providing temporary use of online non-downloadable software for use in management and reporting of aircraft fleets.					
[526]	卸棄 :	N/A					
	Disclaimer:						
[529]	限制 :	N/A					
	Limitation:						
[527]	條件 :	N/A					
	Condition:						
	其他 :	N/A					
	Others						
[220]	提交日期 :	14-01-2022					
	Date of Filing:						
[320]	聲稱具有優先權的日期 :	[310]	優先權申請編號 :	[340]	聲稱具有優先權 (部分) :	[330]	優先權申請的
	Date of Priority Claimed:		Priority Application No.:		Priority Claim Details:		國家、地區、地方 :
							Country, territory, area of Priority Applications:
28-07-2021		90852763		for goods listed in (B) in Class 9; for all services in Class 42.		UNITED STATES OF AMERICA	
28-07-2021		90852774		for services listed in (B) in Class 35; for services listed in (A) in Class 39.		UNITED STATES OF AMERICA	

[210] 商標申請編號 : 305858894
Application No.:

[540] 商標 :
Mark: **WHEELS UP CLOUD SERVICES**

[550] 商標種類 : Ordinary
Mark Type:
一系列商標 : NO
Series Mark:

[571] 商標描述 : N/A
Mark Description:

[730] 註冊申請人的姓名 / 名稱、地址 : Wheels Up Partners LLC
Applicant (s) ' 601 West 26th Street Suite 900
Name, Address: New York, New York 10001
UNITED STATES OF AMERICA

[740/ 註冊申請人的送達地址 : CHINA PATENT AGENT (HONG KONG) LIMITED
750] Applicant's Address for 22/F, Great Eagle Centre,
Service: 23 Harbour Road, Wanchai,
HONG KONG

[511] 類別編號 : 9, 35, 42
Class(es) No(s) .:

[511] 貨品 / 服務說明 : Class 42:
Specification: Providing temporary use of online non-downloadable software for use in business and operations management for aircraft fleet operators, flight operations management, aircraft maintenance reporting and scheduling, aircraft flight scheduling, aircraft crew scheduling, recordkeeping and safety reporting, aircraft fleet vendor and ground services management, aircraft fleet trip services management, air travel client account management, air travel sales tracking and reporting, scheduling and quoting of aircraft bookings; Software as a service (SaaS) and platform as a service (PaaS) featuring online software for use in business and operations management for aircraft fleet operators; Providing temporary use of online non-downloadable software for use in management and reporting of aircraft fleets.

[526] 卸棄 : N/A
Disclaimer:

[529] 限制 : N/A
Limitation:

[527] 條件 : N/A
Condition:
其他 : N/A
Others

[220] 提交日期 : 14-01-2022
Date of Filing:

[320] 聲稱具有優先權的日期 : 28-07-2021

Date of Priority Claimed:

[310] 優先權申請編號: 90852750
Priority Application Number:

[340] 聲稱具有優先權 (部分): N/A
Priority Claim Details:

[330] 優先權申請的 UNITED STATES OF AMERICA
國家、地區、地方:
Country, territory, area of
Priority Applications:

[210] 商標申請編號: 305859433
Application No.:

[540] 商標: **音韻樂心靈 Melody in Mind**
Mark:

[550] 商標種類: Ordinary
Mark Type:

一系列商標: NO
Series Mark:

[571] 商標描述: N/A
Mark Description:

[730] 註冊申請人的姓名 / 名稱、地址: Hong Kong Breast Cancer Foundation Limited
Applicant(s)'
Name, Address: 22/F, Jupiter Tower
9 Jupiter Street, North Point
HONG KONG

[740/ 註冊申請人的送達地址: Pansy Leung Tang & Chua Solicitors
750] Applicant's Address for 21/F, Regent Centre,
Service: No.88 Queen's Road Central
HONG KONG



[511] 類別編號: 16, 36, 41, 42, 44, 45
Class(es) No(s) .:

[511] 貨品 / 服務說明: Class 42:
Specification: Hosting of websites relating to charitable
services and events; scientific and
technological services and research and design
relating thereto; industrial analysis and
research services; design and development of
computer hardware and software.

[526] 卸棄: N/A
Disclaimer:

[529] 限制: N/A
Limitation:

[527] 條件: N/A
Condition:
其他: N/A
Others

[220] 提交日期:	17-01-2022
Date of Filing:	
[320] 聲稱具有優先權的日期:	N/A
Date of Priority Claimed:	
[310] 優先權申請編號:	N/A
Priority Application Number:	
[340] 聲稱具有優先權 (部分):	N/A
Priority Claim Details:	
[330] 優先權申請的 國家、地區、地方:	N/A
Country, territory, area of Priority Applications:	
<hr/>	
[210] 商標申請編號:	305860251
Application No.:	
[540] 商標:	A
Mark:	
	B
	
[550] 商標種類:	Ordinary
Mark Type:	
一系列商標:	YES
Series Mark:	
[571] 商標描述:	N/A
Mark Description:	
[730] 註冊申請人的姓名 / 名稱、地址:	Centre for Perceptual and Interactive Intelligence (CPII) Limited (博智感知交互研究中心 有限公司)
Applicant(s)' Name, Address:	The Chinese University of Hong Kong, Shatin, New Territories, HONG KONG
[740/ 註冊申請人的送達地址:	ACCOLADE IP LIMITED
750] Applicant's Address for Service:	10/F, Fu Fai Comm. Ctr., 27 Hillier Street, Sheung Wan, HONG KONG
[511] 類別編號:	9, 42
Class(es) No(s) .:	
[511] 貨品 / 服務說明:	Class 42:
Specification:	Scientific and technological services and research and design relating thereto; design and development of computer software; developing and programming of computer systems; Platform as a Service [PaaS]; Software as a service [SaaS]; Software as a

service [SaaS] featuring an artificial intelligence (AI) software platform; research in the field of artificial intelligence; developing and programming of software incorporating artificial intelligence and machine learning technology; scientific and technological services, namely, research and develop technology incorporating artificial intelligence (AI) software in the healthcare and medical field; design, research and development of computer software in the field of visual intelligence, speech and language intelligence; research and development of artificial intelligence algorithm for understanding human behavior, environmental conditions and their relationships, as well as visually understand and interpret data; research and development of artificial intelligence technology and AI software that communicates with human speech and language; design, research and development of artificial intelligence software for use in the field of healthcare and medical services as well as smart city services; research and development of product design software and automated manufacturing system software incorporating artificial intelligence technology; programming and providing software in the field of healthcare and medical services; providing online non-downloadable artificial intelligence software; technical consulting in the field of artificial intelligence (AI) software; provision of information in relation to the aforesaid via online website; all the aforesaid services included in Class 42.

- [526] 卸棄 : N/A
Disclaimer:
- [529] 限制 : N/A
Limitation:
- [527] 條件 : N/A
Condition:
其他 : N/A
Others
- [220] 提交日期 : 17-01-2022
Date of Filing:
- [320] 聲稱具有優先權的日期 : N/A
Date of Priority Claimed:
- [310] 優先權申請編號 : N/A
Priority Application Number:
- [340] 聲稱具有優先權 (部分) : N/A
Priority Claim Details:
- [330] 優先權申請的
國家、地區、地方 : N/A

Country, territory, area of
Priority Applications:

[210] 商標申請編號 : 305860828
Application No.:

[540] 商標 :
Mark:

RIOS Architecture

[550] 商標種類 : Ordinary

Mark Type:

一系列商標 : NO

Series Mark:

[571] 商標描述 : N/A

Mark Description:

[730] 註冊申請人的姓名 / 名稱、地址 : Rios, Inc.
Applicant(s) ' 3101 Exposition Pl, Los Angeles, California
Name, Address: 90018

UNITED STATES OF AMERICA

[740/ 註冊申請人的送達地址 :

CHINAHONGKONG IP LIMITED

750] Applicant's Address for
Service:

1502, 15/F, Capital Centre,
151 Gloucester Road, Wanchai
HONG KONG

[511] 類別編號 : 42, 44

Class(es) No(s) .:

[511] 貨品 / 服務說明 :

Specification:

Class 42:

Architectural consultancy; architectural
services; design of interior decor; interior
design; urban planning; research in the field
of building construction; research in the
field of environmental protection;
construction drafting; graphic arts design;
graphic design of promotional materials.

Class 44:

Landscape design; horticulture; landscape
gardening; gardening; flower arranging;
landscape design for others.

[526] 卸棄 : N/A

Disclaimer:

[740/ 註冊申請人的送達地址 : CHINAHONGKONG IP LIMITED
750] Applicant's Address for 1502, 15/F, Capital Centre,
Service: 151 Gloucester Road, Wanchai
HONG KONG

[511] 類別編號 : 42,44
Class(es) No(s) .:

[511] 貨品 / 服務說明 : Class 42:
Specification: Architectural consultancy; architectural
services; design of interior decor; interior
design; urban planning; research in the field
of building construction; research in the
field of environmental protection;
construction drafting; graphic arts design;
graphic design of promotional materials.
Class 44:
Landscape design; horticulture; landscape
gardening; gardening; flower arranging;
landscape design for others.

[526] 卸棄 : N/A
Disclaimer:

[529] 限制 : N/A
Limitation:

[527] 條件 : N/A
Condition:
其他 : N/A
Others

[220] 提交日期 : 17-01-2022
Date of Filing:

[320] 聲稱具有優先權的日期 : N/A
Date of Priority Claimed:

[310] 優先權申請編號 : N/A
Priority Application Number:

[340] 聲稱具有優先權 (部分) : N/A
Priority Claim Details:

[330] 優先權申請的 N/A
國家、地區、地方 :
Country, territory, area of
Priority Applications:

[210] 商標申請編號 : 305861250
Application No.:

[540] 商標：
Mark:



[550] 商標種類：一般商標
Mark Type:
一系列商標：否
Series Mark:

[571] 商標描述：不適用
Mark Description:

[730] 註冊申請人的姓名 / 名稱、地址：TWMN International Limited
Applicant(s) ' 香港
Name, Address: 新界荃灣青山公路荃灣段 388 號
中染大廈 25 樓 01-03 及 05-06 室 06 工作室

[740/ 註冊申請人的送達地址：Jason NG (TWMN International Limited)
750] Applicant's Address for 香港
Service: 新界荃灣青山公路荃灣段 388 號
中染大廈 25 樓 01-03 及 05-06 室 06 工作室

[511] 類別編號：42
Class(es) No(s) .:

[511] 貨品 / 服務說明：類別 42：
Specification: 珠寶設計服務

[526] 卸棄：不適用
Disclaimer:

[529] 限制：不適用
Limitation:

[527] 條件：不適用
Condition:
其他：不適用
Others

[220] 提交日期：18-01-2022
Date of Filing:

[320] 聲稱具有優先權的日期：不適用
Date of Priority Claimed:

[310] 優先權申請編號：不適用
Priority Application Number:

[340] 聲稱具有優先權 (部分)：不適用
Priority Claim Details:

[330] 優先權申請的 不適用

國家、地區、地方:

Country, territory, area of

Priority Applications:

[210] 商標申請編號: 305861683

Application No.:

[540] 商標:

Mark:

M-BODY

[550] 商標種類: 一般商標

Mark Type:

一系列商標:

否

Series Mark:

[571] 商標描述: 不適用

Mark Description:

[730] 註冊申請人的姓名 / 名稱、地址:

普米斯生物技術(珠海)有限公司 (Biotheus Inc.)

Applicant(s)'

中國

Name, Address:

廣東省珠海市

香洲區唐家灣鎮科技七路1號4棟10-B單元, 519080

[740/ 註冊申請人的送達地址:

誠通專利商標(香港)有限公司

750] Applicant's Address for

香港

Service:

灣仔港灣道1號

會展廣場辦公大樓34樓09室

5, 42

[511] 類別編號:

Class(es) No(s) .:

[511] 貨品 / 服務說明:

類別 42:

Specification:

工程學; 技術項目研究; 技術研究; 替他人研究和開發新產品;
科學實驗室服務; 生物學研究; 細菌學研究; 抗體方面的研
究和開發。

[526] 卸棄:

不適用

Disclaimer:

[529] 限制:

不適用

Limitation:

[527] 條件:

不適用

Condition:

其他:

不適用

Others

[220] 提交日期:

18-01-2022

Date of Filing:

[320] 聲稱具有優先權的日期:

不適用

Date of Priority Claimed:

[310] 優先權申請編號:

不適用

Priority Application Number:

[340] 聲稱具有優先權 (部分): 不適用
Priority Claim Details:

[330] 優先權申請的 不適用
國家、地區、地方:
Country, territory, area of
Priority Applications:

[210] 商標申請編號: 305861692
Application No.:

[540] 商標:
Mark:

CABT

[550] 商標種類: 一般商標
Mark Type:
一系列商標: 否
Series Mark:

[571] 商標描述: 不適用
Mark Description:

[730] 註冊申請人的姓名 / 名稱、地址: 普米斯生物技術 (珠海) 有限公司 (Biotheus Inc.)
Applicant(s) ' 中國
Name, Address: 廣東省珠海市

[740/ 註冊申請人的送達地址: 誠通專利商標 (香港) 有限公司
750] Applicant's Address for 香港
Service: 灣仔港灣道 1 號

[511] 類別編號: 會展廣場辦公大樓 34 樓 09 室
Class(es) No(s) .: 5, 42

[511] 貨品 / 服務說明: 類別 42:
Specification: 工程學; 技術項目研究; 技術研究; 替他人研究和開發新產品
; 科學實驗室服務; 生物學研究; 細菌學研究; 抗體方面的研
究和開發。

[526] 卸棄: 不適用
Disclaimer:

[529] 限制: 不適用
Limitation:

[527] 條件: 不適用
Condition:
其他: 不適用
Others

[220] 提交日期: 18-01-2022
Date of Filing:

[320] 聲稱具有優先權的日期: 不適用

Date of Priority Claimed:

[310] 優先權申請編號: 不適用

Priority Application Number:

[340] 聲稱具有優先權 (部分): 不適用

Priority Claim Details:

[330] 優先權申請的 不適用

國家、地區、地方:

Country, territory, area of

Priority Applications:

[210] 商標申請編號: 305861719

Application No.:

[540] 商標:

Mark:

BiTA

[550] 商標種類: 一般商標

Mark Type:

一系列商標:

否

Series Mark:

[571] 商標描述: 不適用

Mark Description:

[730] 註冊申請人的姓名 / 名稱、地址:

普米斯生物技術 (珠海) 有限公司 (Biotheus Inc.)

Applicant(s)'

中國

Name, Address:

廣東省珠海市

香洲區唐家灣鎮科技七路 1 號 4 棟 10-B 單元, 519080

[740/ 註冊申請人的送達地址:

誠通專利商標 (香港) 有限公司

750] Applicant's Address for

香港

Service:

灣仔港灣道 1 號

會展廣場辦公大樓 34 樓 09 室

[511] 類別編號: 5, 42

Class(es) No(s) .:

[511] 貨品 / 服務說明: 類別 42:

Specification:

工程學; 技術項目研究; 技術研究; 替他人研究和開發新產品
; 科學實驗室服務; 生物學研究; 細菌學研究; 抗體方面的研
究和開發。

[526] 卸棄: 不適用

Disclaimer:

[529] 限制: 不適用

Limitation:

[527] 條件: 不適用

Condition:

其他:

不適用

Others

[220] 提交日期: 18-01-2022
Date of Filing:
[320] 聲稱具有優先權的日期: 不適用
Date of Priority Claimed:
[310] 優先權申請編號: 不適用
Priority Application Number:
[340] 聲稱具有優先權 (部分): 不適用
Priority Claim Details:
[330] 優先權申請的 不適用
國家、地區、地方:
Country, territory, area of
Priority Applications:

[210] 商標申請編號: 305861728
Application No.:

[540] 商標:
Mark:

CAB-NK

[550] 商標種類: 一般商標
Mark Type:
一系列商標: 否
Series Mark:

[571] 商標描述: 不適用
Mark Description:

[730] 註冊申請人的姓名 / 名稱、地址: 普米斯生物技術 (珠海) 有限公司 (Biotheus Inc.)
Applicant(s) ' 中國
Name, Address: 廣東省珠海市

香洲區唐家灣鎮科技七路 1 號 4 棟 10-B 單元, 519080

[740/ 註冊申請人的送達地址: 誠通專利商標 (香港) 有限公司

750] Applicant's Address for 香港
Service: 灣仔港灣道 1 號

[511] 類別編號: 5, 42
Class(es) No(s) .:

[511] 貨品 / 服務說明: 類別 42:
Specification: 工程學; 技術項目研究; 技術研究; 替他人研究和開發新產品
; 科學實驗室服務; 生物學研究; 細菌學研究; 抗體方面的研
究和開發。

[526] 卸棄: 不適用
Disclaimer:

[529] 限制: 不適用
Limitation:

[527] 條件: 不適用
Condition:

其他 : 不適用
Others

[220] 提交日期 : 18-01-2022
Date of Filing:

[320] 聲稱具有優先權的日期 : 不適用
Date of Priority Claimed:

[310] 優先權申請編號 : 不適用
Priority Application Number:

[340] 聲稱具有優先權 (部分) : 不適用
Priority Claim Details:

[330] 優先權申請的
國家、地區、地方 : 不適用
Country, territory, area of
Priority Applications:

[210] 商標申請編號 : 305861755
Application No.:

[540] 商標 :
Mark:



[550] 商標種類 : Ordinary
Mark Type:

一系列商標 : NO
Series Mark:

[571] 商標描述 : N/A
Mark Description:

[730] 註冊申請人的姓名 / 名稱、地址 : V8 Global Company Ltd
Applicant(s) ' West Wing 2/F, 822 Lai Chi Kok Road,
Name,Address: Cheung Sha Wan, Kowloon
HONG KONG

[740/ 註冊申請人的送達地址 : Incredible Innovation Group Limited
750] Applicant's Address for West Wing 2/F, 822 Lai Chi Kok Road,
Service: Cheung Sha Wan, Kowloon
HONG KONG

[511] 類別編號 : 9, 42

Class(es) No(s) .:

- [511] 貨品 / 服務說明 : Class 42:
Specification: hosting an online platform on the Internet
- [526] 卸棄 : N/A
Disclaimer:
- [529] 限制 : N/A
Limitation:
- [527] 條件 : N/A
Condition:
其他 : N/A
Others
- [220] 提交日期 : 18-01-2022
Date of Filing:
- [320] 聲稱具有優先權的日期 : N/A
Date of Priority Claimed:
- [310] 優先權申請編號 : N/A
Priority Application Number:
- [340] 聲稱具有優先權 (部分) : N/A
Priority Claim Details:
- [330] 優先權申請的
國家、地區、地方 : N/A
Country, territory, area of
Priority Applications:

-
- [210] 商標申請編號 : 305861764
Application No.:
- [540] 商標 :
Mark:

客族

- [550] 商標種類 : 一般商標
Mark Type:
一系列商標 : 否
Series Mark:
- [571] 商標描述 : 不適用
Mark Description:
- [730] 註冊申請人的姓名 / 名稱、地址 : 廣州市客族鋼結構設計安裝有限公司
Applicant(s) ' 中國
Name, Address: 廣東省廣州市
白雲區人和鎮鶴龍五路 405 號 101 房

[740/ 註冊申請人的送達地址 : 香港智網知識產權服務有限公司
750] Applicant's Address for 香港
Service: 九龍旺角花園街 2-16 號
好景商業中心 27/F 18 室

[511] 類別編號 : 6, 19, 35, 37, 42
Class(es) No(s) .:

[511] 貨品 / 服務說明 : 類別 42:
Specification: 地質勘測; 室內裝飾設計; 工程繪圖; 建築製圖; 建築學諮詢;
建築學服務; 材料測試; 材料測試; 環境保護領域的研究;
質量控制

[526] 卸棄 : 不適用
Disclaimer:

[529] 限制 : 不適用
Limitation:

[527] 條件 : 不適用
Condition:
其他 : 不適用
Others

[220] 提交日期 : 18-01-2022
Date of Filing:

[320] 聲稱具有優先權的日期 : 不適用
Date of Priority Claimed:

[310] 優先權申請編號 : 不適用
Priority Application Number:

[340] 聲稱具有優先權 (部分) : 不適用
Priority Claim Details:

[330] 優先權申請的 不適用
國家、地區、地方 :
Country, territory, area of
Priority Applications:

[210] 商標申請編號 : 305861917
Application No.:

[540] 商標：
Mark:



美味不用等

[550] 商標種類：一般商標
Mark Type:
一系列商標：否
Series Mark:

[571] 商標描述：不適用
Mark Description:

[730] 註冊申請人的姓名 / 名稱、地址：
Applicant(s) ' Name, Address: 美味不用等 (上海) 信息科技股份有限公司 (Seatnow (Shanghai) Information Technology Co., Ltd.)
中國
中國 (上海) 自由貿易試驗區
祖沖之路 887 弄 88 號樓 302 室

[740/ 註冊申請人的送達地址：
750] Applicant's Address for Service: 香港
九龍旺角煙廠街 9 號
興發商業大廈 7 樓 703 室

[511] 類別編號：9, 35, 36, 38, 42, 43
Class(es) No(s) .:

[511] 貨品 / 服務說明：
Specification: 類別 42:
技術研究；計算機軟件設計；軟件即服務 (SaaS)；平臺即服務 (PaaS)；電子數據存儲；雲計算；計算機軟件諮詢；計算機安全和風險防範用軟件的維護；手機應用軟件的設計和開發；信息技術諮詢服務；電子數據備份服務；使用生物識別硬件和軟件技術為電子商務交易提供用戶認證服務；電子收款機系統用計算機程序開發；替他人稱量貨物。

[526] 卸棄：不適用
Disclaimer:

[529] 限制：不適用
Limitation:

[527] 條件：不適用
Condition:
其他：不適用
Others

[220] 提交日期：18-01-2022
Date of Filing:

[320] 聲稱具有優先權的日期：不適用

Date of Priority Claimed:

- [310] 優先權申請編號: 不適用
Priority Application Number:
- [340] 聲稱具有優先權 (部分): 不適用
Priority Claim Details:
- [330] 優先權申請的 不適用
國家、地區、地方:
Country, territory, area of
Priority Applications:

-
- [210] 商標申請編號: 305861962
Application No.:
- [540] 商標: A
Mark:



B



- [550] 商標種類: 一般商標
Mark Type:
一系列商標: 是
Series Mark:
- [571] 商標描述: 不適用
Mark Description:
- [730] 註冊申請人的姓名 / 名稱、地址: 宜明昂科生物醫藥技術(上海)有限公司
Applicant(s) ' 中國
Name, Address: 上海浦東新區
張衡路 1000 弄 15 棟
- [740/ 註冊申請人的送達地址: 麥仕奇知識產權
750] Applicant's Address for 香港
Service: 薄扶林 數碼港道 100 號
數碼港一座 9 樓
- [511] 類別編號: 5, 42
Class(es) No(s) .:

[511] 貨品 / 服務說明 : Specification:	類別 42: 科學技術服務和與之相關的研究與設計服務; 工業分析與工業研究服務; 人用藥、藥品、藥劑、藥用化學製劑、生化藥品、醫用生物製劑、生物藥品之開發及研究服務; 全部屬於第 42 類。
[526] 卸棄 : Disclaimer:	不適用
[529] 限制 : Limitation:	不適用
[527] 條件 : Condition:	不適用
其他 : Others	不適用
[220] 提交日期 : Date of Filing:	19-01-2022
[320] 聲稱具有優先權的日期 : Date of Priority Claimed:	不適用
[310] 優先權申請編號 : Priority Application Number:	不適用
[340] 聲稱具有優先權 (部分) : Priority Claim Details:	不適用
[330] 優先權申請的 國家、地區、地方 : Country, territory, area of Priority Applications:	不適用

[210] 商標申請編號 : 305862105
Application No.:

[540] 商標 :
Mark:

FLEX-NK

[550] 商標種類 : Ordinary
Mark Type:
一系列商標 : NO
Series Mark:

[571] 商標描述 : N/A
Mark Description:

[730] 註冊申請人的姓名 / 名稱、地址 : Cytovia Therapeutics, Inc.
Applicant(s) ' 18851 NE 29th Ave.
Name, Address: 2nd Floor, Aventura, Florida 33180
UNITED STATES OF AMERICA

[740/ 註冊申請人的送達地址 : VIVIEN CHAN & CO
750] Applicant's Address for 32/F, Harbour Centre,
Service:

25 Harbour Road, Wanchai,
HONG KONG

- [511] 類別編號 : 42
Class(es) No(s) .:
- [511] 貨品 / 服務說明 : Class 42:
Specification: Providing technological information in the field of antibodies, natural killer cells, and pharmaceutical preparations for the treatment of cancer and tumors
- [526] 卸棄 : N/A
Disclaimer:
- [529] 限制 : N/A
Limitation:
- [527] 條件 : N/A
Condition:
其他 : N/A
Others
- [220] 提交日期 : 19-01-2022
Date of Filing:
- [320] 聲稱具有優先權的日期 : 30-09-2021
Date of Priority Claimed:
- [310] 優先權申請編號 : 97053648
Priority Application Number:
- [340] 聲稱具有優先權 (部分) : N/A
Priority Claim Details:
- [330] 優先權申請的
國家、地區、地方 : UNITED STATES OF AMERICA
Country, territory, area of
Priority Applications:
-
-

- [210] 商標申請編號 : 305862114
Application No.:

- [540] 商標 :
Mark:



[550] 商標種類: Ordinary
Mark Type:
一系列商標: NO
Series Mark:

[571] 商標描述: N/A
Mark Description:

[730] 註冊申請人的姓名 / 名稱、地址: Cytovia Therapeutics, Inc.
Applicant(s) ' 18851 NE 29th Ave.
Name,Address: 2nd Floor, Aventura, Florida 33180
UNITED STATES OF AMERICA

[740/ 註冊申請人的送達地址: VIVIEN CHAN & CO
750] Applicant's Address for 32/F, Harbour Centre,
Service: 25 Harbour Road, Wanchai,
HONG KONG

[511] 類別編號: 5,42
Class(es) No(s) .:

[511] 貨品 / 服務說明: Class 42:
Specification: Research and development in the field of
immunotherapy; research and development in the
field of cancer treatment; research and
development in the field of natural killer
cells

[526] 卸棄: N/A
Disclaimer:

[529] 限制: N/A
Limitation:

[527] 條件: N/A
Condition:
其他: N/A
Others

[220] 提交日期: 19-01-2022
Date of Filing:

[320] 聲稱具有優先權的日期: 19-07-2021
Date of Priority Claimed:

[310] 優先權申請編號: 90836124
Priority Application Number:

[340] 聲稱具有優先權 (部分): N/A
Priority Claim Details:

[330] 優先權申請的 UNITED STATES OF AMERICA
國家、地區、地方:
Country, territory, area of
Priority Applications:

[210] 商標申請編號: 305862123
Application No.:

[540] 商標 :
Mark:

CYTOVIA

[550] 商標種類 : Ordinary
Mark Type:
一系列商標 : NO
Series Mark:

[571] 商標描述 : N/A
Mark Description:

[730] 註冊申請人的姓名 / 名稱、地址 : Cytovia Therapeutics, Inc.
Applicant(s) ' 18851 NE 29th Ave.
Name, Address: 2nd Floor, Aventura, Florida 33180
UNITED STATES OF AMERICA

[740/ 註冊申請人的送達地址 : VIVIEN CHAN & CO
750] Applicant's Address for 32/F, Harbour Centre,
Service: 25 Harbour Road, Wanchai,
HONG KONG

[511] 類別編號 : 5, 42
Class(es) No(s) .:

[511] 貨品 / 服務說明 : Class 42:
Specification: Research and development in the field of
immunotherapy; research and development in the
field of cancer treatment; research and
development in the field of natural killer
cells

[526] 卸棄 : N/A
Disclaimer:

[529] 限制 : N/A
Limitation:

[527] 條件 : N/A
Condition:
其他 : N/A
Others

[220] 提交日期 : 19-01-2022
Date of Filing:

[320] 聲稱具有優先權的日期 : 19-07-2021
Date of Priority Claimed:

[310] 優先權申請編號 : 90836122
Priority Application Number:

[340] 聲稱具有優先權 (部分) : N/A
Priority Claim Details:

[330] 優先權申請的 UNITED STATES OF AMERICA
國家、地區、地方 :
Country, territory, area of
Priority Applications:

[210] 商標申請編號: 305863177
Application No.:

[540] 商標:
Mark:

age of doom

[550] 商標種類: Ordinary
Mark Type:
一系列商標: NO
Series Mark:

[571] 商標描述: N/A
Mark Description:

[730] 註冊申請人的姓名 / 名稱、地址:
Applicant(s) ' Name,Address: Hong Kong Ke Mo software Co., Limited
9/F., MW Tower,
No.111 Bonham Strand, Sheung Wan,
HONG KONG

[740/ 註冊申請人的送達地址:
750] Applicant's Address for Service: HONG KONG VICTORY INTELLECTUAL PROPERTY AGENT
CO., LIMITED
RM 703,7/F PROSPER COMM BLDG,
9 YIN CHONG ST, MONGKOK, KLN,
HONG KONG

[511] 類別編號: 9,41,42
Class(es) No(s) .:

[511] 貨品 / 服務說明:
Specification: Class 42:
Updating of computer software; Maintenance of
computer software; Computer software
consultancy; Installation of computer
software; Website design consultancy;
Consultancy in the design and development of
computer hardware; Information technology [IT]
consultancy; Computer programming; Computer
software design; Software as a service [SaaS];
Design and development of computer game
software; Development of computer hardware for
computer games; Computer programming of video
games; Development of video and computer
games; Programming of computer games.

[526] 卸棄: N/A
Disclaimer:

[529] 限制: N/A
Limitation:

[527] 條件: N/A
Condition:
其他: N/A
Others

[220] 提交日期: 19-01-2022
Date of Filing:

[320] 聲稱具有優先權的日期: N/A
Date of Priority Claimed:

[310] 優先權申請編號: N/A
Priority Application Number:

[340] 聲稱具有優先權 (部分): N/A
Priority Claim Details:

[330] 優先權申請的 N/A
國家、地區、地方:
Country, territory, area of
Priority Applications:

[210] 商標申請編號: 305863186
Application No.:

[540] 商標:
Mark:

Age of Evil

[550] 商標種類: Ordinary
Mark Type:

一系列商標: NO
Series Mark:

[571] 商標描述: N/A
Mark Description:

[730] 註冊申請人的姓名 / 名稱、地址: Hong Kong Ke Mo software Co., Limited
Applicant(s) ' 9/F., MW Tower,
Name,Address: No.111 Bonham Strand, Sheung Wan,
HONG KONG

[740/ 註冊申請人的送達地址: HONG KONG VICTORY INTELLECTUAL PROPERTY AGENT
750] Applicant's Address for CO., LIMITED
Service: RM 703,7/F PROSPER COMM BLDG,

9 YIN CHONG ST, MONGKOK, KLN,
HONG KONG

[511] 類別編號: 9,41,42
Class(es) No(s) .:

[511] 貨品 / 服務說明: Class 42:
Specification: Updating of computer software; Maintenance of
computer software; Computer software
consultancy; Installation of computer
software; Website design consultancy;
Consultancy in the design and development of
computer hardware; Information technology [IT]
consultancy; Computer programming; Computer
software design; Software as a service [SaaS];
Design and development of computer game
software; Development of computer hardware for
computer games; Computer programming of video
games; Development of video and computer
games; Programming of computer games.

[526] 卸棄: N/A
Disclaimer:

[529] 限制: N/A
Limitation:

[527]	條件 :	N/A
	Condition:	
	其他 :	N/A
	Others	
[220]	提交日期 :	19-01-2022
	Date of Filing:	
[320]	聲稱具有優先權的日期 :	N/A
	Date of Priority Claimed:	
[310]	優先權申請編號 :	N/A
	Priority Application Number:	
[340]	聲稱具有優先權 (部分) :	N/A
	Priority Claim Details:	
[330]	優先權申請的 國家、地區、地方 :	N/A
	Country, territory, area of Priority Applications:	
<hr/>		
[210]	商標申請編號 :	305863195
	Application No.:	
[540]	商標 :	
	Mark:	Age of Apocalypse
[550]	商標種類 :	Ordinary
	Mark Type:	
	一系列商標 :	NO
	Series Mark:	
[571]	商標描述 :	N/A
	Mark Description:	
[730]	註冊申請人的姓名 / 名稱、地址 :	Hong Kong Ke Mo software Co., Limited
	Applicant(s)' Name, Address:	9/F., MW Tower, No.111 Bonham Strand, Sheung Wan, HONG KONG
[740/750]	註冊申請人的送達地址 :	HONG KONG VICTORY INTELLECTUAL PROPERTY AGENT
	Applicant's Address for Service:	CO., LIMITED RM 703, 7/F PROSPER COMM BLDG, 9 YIN CHONG ST, MONGKOK, KLN, HONG KONG
[511]	類別編號 :	9, 41, 42
	Class(es) No(s) .:	
[511]	貨品 / 服務說明 :	Class 42:
	Specification:	Updating of computer software; Maintenance of computer software; Computer software consultancy; Installation of computer software; Website design consultancy; Consultancy in the design and development of computer hardware; Information technology [IT]

consultancy; Computer programming; Computer software design; Software as a service [SaaS]; Design and development of computer game software; Development of computer hardware for computer games; Computer programming of video games; Development of video and computer games; Programming of computer games.

- [526] 卸棄: N/A
Disclaimer:
- [529] 限制: N/A
Limitation:
- [527] 條件: N/A
Condition:
其他: N/A
Others
- [220] 提交日期: 19-01-2022
Date of Filing:
- [320] 聲稱具有優先權的日期: N/A
Date of Priority Claimed:
- [310] 優先權申請編號: N/A
Priority Application Number:
- [340] 聲稱具有優先權 (部分): N/A
Priority Claim Details:
- [330] 優先權申請的
國家、地區、地方: N/A
Country, territory, area of
Priority Applications:

-
- [210] 商標申請編號: 305863519
Application No.:
- [540] 商標: A
Mark:

商對易

B

商对易

- [550] 商標種類: Ordinary
Mark Type:

	一系列商標 :	YES
	Series Mark:	
[571]	商標描述 :	N/A
	Mark Description:	
[730]	註冊申請人的姓名 / 名稱、地址 :	Hong Kong Trade Development Council
	Applicant(s) ' Name,Address:	38th Floor, Office Tower, Convention Plaza, 1 Harbour Road, Wanchai, HONG KONG
[740/	註冊申請人的送達地址 :	BIRD & BIRD
750]	Applicant's Address for Service:	6/F, The Annex, Central Plaza 18 Harbour Road HONG KONG
[511]	類別編號 :	35,38,42
	Class(es) No(s) .:	
[511]	貨品 / 服務說明 :	Class 42:
	Specification:	Hosting of computer site; hosting of websites providing online business platforms; hosting of websites for business matching of enterprises; hosting of websites for registration of participation in conferences, seminars, workshops, trade fairs and business matching opportunities; platform as a service [PaaS]; development of computer platforms; hosting of e-commerce platforms on the Internet; computer development services for Intranet and web-based portals; design, development and maintenance of websites and web portals; computer programming, updating of computer software; computer software design; maintenance of computer software; computer systems analysis; graphic arts designing; recovery of computer data; providing a web site and home page all featuring research and reference materials in the field of business, finance, news, weather, sports, entertainment, travel, shipping, computing, computer software, music, theatre, movies, hobbies, computer support education, lifestyles and general interest; computer consultancy in the field of internet services; information, advisory and consultancy services relating to all the aforesaid services; all of the aforesaid also provided online via the Internet or any other interactive electronic platforms; all included in Class 42.
[526]	卸棄 :	N/A
	Disclaimer:	
[529]	限制 :	N/A
	Limitation:	
[527]	條件 :	N/A
	Condition:	
	其他 :	N/A
	Others	
[220]	提交日期 :	20-01-2022

Date of Filing:

- [320] 聲稱具有優先權的日期: N/A
Date of Priority Claimed:
- [310] 優先權申請編號: N/A
Priority Application Number:
- [340] 聲稱具有優先權 (部分): N/A
Priority Claim Details:
- [330] 優先權申請的
國家、地區、地方:
Country, territory, area of
Priority Applications:

-
- [210] 商標申請編號: 305863528
Application No.:

- [540] 商標: A
Mark:



B



- [550] 商標種類: Ordinary
Mark Type:
一系列商標: YES
Series Mark:
- [571] 商標描述: N/A
Mark Description:
- [730] 註冊申請人的姓名 / 名稱、地址: Hong Kong Trade Development Council
Applicant(s) ' 38th Floor, Office Tower, Convention Plaza,
Name,Address: 1 Harbour Road, Wanchai,
HONG KONG

[740/ 註冊申請人的送達地址 : BIRD & BIRD
750] Applicant's Address for 6/F, The Annex, Central Plaza
Service: 18 Harbour Road
HONG KONG

[511] 類別編號 : 35,38,42
Class(es) No(s) .:

[511] 貨品 / 服務說明 : Class 42:
Specification: Hosting of computer site; hosting of websites
providing online business platforms; hosting
of websites for business matching of
enterprises; hosting of websites for
registration of participation in conferences,
seminars, workshops, trade fairs and business
matching opportunities; platform as a service
[PaaS]; development of computer platforms;
hosting of e-commerce platforms on the
Internet; computer development services for
Intranet and web-based portals; design,
development and maintenance of websites and
web portals; computer programming, updating of
computer software; computer software design;
maintenance of computer software; computer
systems analysis; graphic arts designing;
recovery of computer data; providing a web
site and home page all featuring research and
reference materials in the field of business,
finance, news, weather, sports, entertainment,
travel, shipping, computing, computer
software, music, theatre, movies, hobbies,
computer support education, lifestyles and
general interest; computer consultancy in the
field of internet services; information,
advisory and consultancy services relating to
all the aforesaid services; all of the
aforesaid also provided online via the
Internet or any other interactive electronic
platforms; all included in Class 42.

[526] 卸棄 : N/A
Disclaimer:

[529] 限制 : N/A
Limitation:

[527] 條件 : N/A
Condition:
其他 : N/A
Others

[220] 提交日期 : 20-01-2022
Date of Filing:

[320] 聲稱具有優先權的日期 : N/A
Date of Priority Claimed:

[310] 優先權申請編號 : N/A
Priority Application Number:

[340] 聲稱具有優先權 (部分) : N/A
Priority Claim Details:

[330] 優先權申請的 N/A

國家、地區、地方：

Country, territory, area of
Priority Applications:

[210] 商標申請編號： 305863537
Application No.:

[540] 商標：
Mark:



[550] 商標種類： Ordinary
Mark Type:
一系列商標： NO
Series Mark:

[571] 商標描述： The applicant claims the colours orange, light orange and grey as elements of the trade mark.
Mark Description:

[730] 註冊申請人的姓名 / 名稱、地址： Hong Kong Trade Development Council
Applicant(s) ' 38th Floor, Office Tower, Convention Plaza,
Name, Address: 1 Harbour Road, Wanchai,
HONG KONG

[740/ 註冊申請人的送達地址： BIRD & BIRD
750] Applicant's Address for 6/F, The Annex, Central Plaza
Service: 18 Harbour Road
HONG KONG

[511] 類別編號： 35, 38, 42
Class(es) No(s) .:

[511] 貨品 / 服務說明： Class 42:
Specification: Hosting of computer site; hosting of websites providing online business platforms; hosting of websites for business matching of enterprises; hosting of websites for registration of participation in conferences, seminars, workshops, trade fairs and business matching opportunities; platform as a service [PaaS]; development of computer platforms; hosting of e-commerce platforms on the Internet; computer development services for Intranet and web-based portals; design, development and maintenance of websites and web portals; computer programming, updating of computer software; computer software design; maintenance of computer software; computer systems analysis; graphic arts designing; recovery of computer data; providing a web site and home page all featuring research and reference materials in the field of business, finance, news, weather, sports, entertainment, travel, shipping, computing, computer software, music, theatre, movies, hobbies,

computer support education, lifestyles and general interest; computer consultancy in the field of internet services; information, advisory and consultancy services relating to all the aforesaid services; all of the aforesaid also provided online via the Internet or any other interactive electronic platforms; all included in Class 42.

- [526] 卸棄 : N/A
Disclaimer:
- [529] 限制 : N/A
Limitation:
- [527] 條件 : N/A
Condition:
其他 : N/A
Others
- [220] 提交日期 : 20-01-2022
Date of Filing:
- [320] 聲稱具有優先權的日期 : N/A
Date of Priority Claimed:
- [310] 優先權申請編號 : N/A
Priority Application Number:
- [340] 聲稱具有優先權 (部分) : N/A
Priority Claim Details:
- [330] 優先權申請的
國家、地區、地方 : N/A
Country, territory, area of
Priority Applications:

- [210] 商標申請編號 : 305863753
Application No.:

- [540] 商標 :
Mark:



Time Bene

- [550] 商標種類 : 一般商標
Mark Type:

- 一系列商標 : 否
Series Mark:
- [571] 商標描述 : 申請人聲稱綠色及黃色為商標的多於一個要素。
Mark Description:
- [730] 註冊申請人的姓名 / 名稱、地址 : 金賦國際科技有限公司
Applicant(s) ' 香港
Name, Address: 銅鑼灣禮頓道 103 號
力寶禮頓大廈 7 樓 B 室
- [740/ 註冊申請人的送達地址 : 金賦國際科技有限公司
750] Applicant's Address for 香港
Service: 銅鑼灣禮頓道 103 號
力寶禮頓大廈 7 樓 B 室
- [511] 類別編號 : 9, 35, 42
Class(es) No(s) .:
- [511] 貨品 / 服務說明 : 類別 42:
Specification: 科學技術服務和與之相關的研究與設計服務; 計算機硬件與軟件的設計與開發
- [526] 卸棄 : 不適用
Disclaimer:
- [529] 限制 : 不適用
Limitation:
- [527] 條件 : 不適用
Condition:
其他 : 不適用
Others
- [220] 提交日期 : 20-01-2022
Date of Filing:
- [320] 聲稱具有優先權的日期 : 不適用
Date of Priority Claimed:
- [310] 優先權申請編號 : 不適用
Priority Application Number:
- [340] 聲稱具有優先權 (部分) : 不適用
Priority Claim Details:
- [330] 優先權申請的 不適用
國家、地區、地方 :
Country, territory, area of
Priority Applications:
-
-

[210] 商標申請編號 : 305863852
Application No.:

[540] 商標 : **DISGUISE RENDERSTREAM**
Mark:

[550] 商標種類: Ordinary
Mark Type:
一系列商標: NO
Series Mark:

[571] 商標描述: N/A
Mark Description:

[730] 註冊申請人的姓名 / 名稱、地址: Disguise Technologies Limited
Applicant(s) ' 88-89 Blackfriars Road
Name, Address: London, SE1 8HA
UNITED KINGDOM

[740/ 註冊申請人的送達地址: BENNY KONG & TSAI
750] Applicant's Address for Unit 19B, Overseas Trust Bank Building
Service: No. 160 Gloucester Road, Wanchai
HONG KONG

[511] 類別編號: 9, 42
Class(es) No(s) .:

[511] 貨品 / 服務說明: Class 42:
Specification: Providing temporary use of non-downloadable
cloud-based software for the design,
production, managing, simulation, playback and
control of live shows, live events, live event
multimedia installations, video content, film
and TV production.

[526] 卸棄: N/A
Disclaimer:

[529] 限制: N/A
Limitation:

[527] 條件: N/A
Condition:
其他: N/A
Others

[220] 提交日期: 20-01-2022
Date of Filing:

[320] 聲稱具有優先權的日期: 22-07-2021
Date of Priority Claimed:

[310] 優先權申請編號: 90842976
Priority Application Number:

[340] 聲稱具有優先權 (部分): N/A
Priority Claim Details:

[330] 優先權申請的 UNITED STATES OF AMERICA
國家、地區、地方:
Country, territory, area of
Priority Applications:

[210] 商標申請編號: 305863861
Application No.:

[540] 商標: **DISGUISE SCENESTREAM**

Mark:

- [550] 商標種類: Ordinary
Mark Type:
一系列商標: NO
Series Mark:
- [571] 商標描述: N/A
Mark Description:
- [730] 註冊申請人的姓名 / 名稱、地址: Disguise Technologies Limited
Applicant(s) ' 88-89 Blackfriars Road
Name, Address: London, SE1 8HA
UNITED KINGDOM
- [740/ 註冊申請人的送達地址: BENNY KONG & TSAI
750] Applicant's Address for Unit 19B, Overseas Trust Bank Building
Service: No. 160 Gloucester Road, Wanchai
HONG KONG
- [511] 類別編號: 9, 42
Class(es) No(s) .:
- [511] 貨品 / 服務說明: Class 42:
Specification: Providing temporary use of non-downloadable
cloud-based software for the design,
production, managing, simulation, playback and
control of live shows, live events, live event
multimedia installations, video content, film
and TV production.
- [526] 卸棄: N/A
Disclaimer:
- [529] 限制: N/A
Limitation:
- [527] 條件: N/A
Condition:
其他: N/A
Others
- [220] 提交日期: 20-01-2022
Date of Filing:
- [320] 聲稱具有優先權的日期: 22-07-2021
Date of Priority Claimed:
- [310] 優先權申請編號: 90842987
Priority Application Number:
- [340] 聲稱具有優先權 (部分): N/A
Priority Claim Details:
- [330] 優先權申請的 UNITED STATES OF AMERICA
國家、地區、地方:
Country, territory, area of
Priority Applications:
-
-

- [210] 商標申請編號: 305864941
Application No.:
- [540] 商標:
Mark:
- # AGILEX
- [550] 商標種類: 一般商標
Mark Type:
一系列商標: 否
Series Mark:
- [571] 商標描述: 不適用
Mark Description:
- [730] 註冊申請人的姓名 / 名稱、地址:
Applicant (s) '敏捷雲計算科技有限公司 (AGILEWING TECHNOLOGY CO. LIMITED)
Name, Address: 香港
香港島西環
干諾道西 118 號 20 樓 09 室
- [740/ 註冊申請人的送達地址:
750] Applicant's Address for
Service: 滙誠知識產權有限公司
香港
灣仔軒尼詩道 8-12 號
中港大廈 8 樓
- [511] 類別編號:
Class(es) No(s) .: 35, 42
- [511] 貨品 / 服務說明:
Specification: 類別 42:
軟件即服務 (SaaS); 信息技術諮詢服務; 遠程數據備份; 通過雲計算提供虛擬計算機系統; 外包商提供的信息技術服務; 計算機技術諮詢; 計算機安全諮詢; 互聯網安全諮詢; 數據安全諮詢; 數據加密服務
- [526] 卸棄:
Disclaimer: 不適用
- [529] 限制:
Limitation: 不適用
- [527] 條件:
Condition: 不適用
其他:
Others: 不適用
- [220] 提交日期:
Date of Filing: 21-01-2022
- [320] 聲稱具有優先權的日期:
Date of Priority Claimed: 不適用
- [310] 優先權申請編號:
Priority Application Number: 不適用
- [340] 聲稱具有優先權 (部分):
Priority Claim Details: 不適用
- [330] 優先權申請的
國家、地區、地方:
Country, territory, area of
Priority Applications: 不適用

[210] 商標申請編號: 305864978

Application No.:

[540] 商標:

Mark:



[550] 商標種類: 一般商標

Mark Type:

一系列商標:

否

Series Mark:

[571] 商標描述: 不適用

Mark Description:

[730] 註冊申請人的姓名 / 名稱、地址:

敏捷雲計算科技有限公司 (AGILEWING TECHNOLOGY CO. LIMITED)

Applicant(s) 'Name, Address:

香港

香港島西環

干諾道西 118 號 20 樓 09 室

[740/ 註冊申請人的送達地址:

滙誠知識產權有限公司

750] Applicant's Address for

香港

Service:

灣仔軒尼詩道 8-12 號

中港大廈 8 樓

[511] 類別編號:

35, 42

Class(es) No(s) .:

[511] 貨品 / 服務說明:

類別 42:

Specification:

軟件即服務 (SaaS); 信息技術諮詢服務; 遠程數據備份; 通過雲計算提供虛擬計算機系統; 外包商提供的信息技術服務; 計算機技術諮詢; 計算機安全諮詢; 互聯網安全諮詢; 數據安全諮詢; 數據加密服務

[526] 卸棄:

不適用

Disclaimer:

[529] 限制:

不適用

Limitation:

[527] 條件:

不適用

Condition:

其他:

不適用

Others

[220] 提交日期:

21-01-2022

Date of Filing:

[320] 聲稱具有優先權的日期:

不適用

Date of Priority Claimed:

[310] 優先權申請編號:

不適用

Priority Application Number:

[340] 聲稱具有優先權 (部分): 不適用

Priority Claim Details:

[330] 優先權申請的 不適用

國家、地區、地方:

Country, territory, area of
Priority Applications:

[210] 商標申請編號: 305865003

Application No.:

[540] 商標:

Mark:

敏捷云

[550] 商標種類: 一般商標

Mark Type:

一系列商標:

否

Series Mark:

[571] 商標描述: 不適用

Mark Description:

[730] 註冊申請人的姓名 / 名稱、地址:

敏捷雲計算科技有限公司 (AGILEWING TECHNOLOGY CO.
LIMITED)

Applicant(s) '

Name, Address:

香港

香港島西環

干諾道西 118 號 20 樓 09 室

[740/ 註冊申請人的送達地址:

滙誠知識產權有限公司

750] Applicant's Address for

香港

Service:

灣仔軒尼詩道 8-12 號

中港大廈 8 樓

[511] 類別編號: 35, 42

Class(es) No(s) .:

[511] 貨品 / 服務說明: 類別 42:

Specification:

軟件即服務 (SaaS); 信息技術諮詢服務; 遠程數據備份; 通過雲計算提供虛擬計算機系統; 外包商提供的信息技術服務; 計算機技術諮詢; 計算機安全諮詢; 互聯網安全諮詢; 數據安全諮詢; 數據加密服務

[526] 卸棄: 不適用

Disclaimer:

[529] 限制: 不適用

Limitation:

[527] 條件: 不適用

Condition:

其他:

不適用

Others

[220] 提交日期: 21-01-2022

Date of Filing:

[320] 聲稱具有優先權的日期 : 不適用
Date of Priority Claimed:

[310] 優先權申請編號 : 不適用
Priority Application Number:

[340] 聲稱具有優先權 (部分) : 不適用
Priority Claim Details:

[330] 優先權申請的 不適用
國家、地區、地方 :
Country, territory, area of
Priority Applications:

[210] 商標申請編號 : 305865788
Application No.:

[540] 商標 :
Mark:

The logo for Curigokids features the brand name in a bold, lowercase, sans-serif font. The letter 'o' in 'igokids' is stylized as a black circle with a white dot in the center, resembling an eye or a camera lens.

[550] 商標種類 : Ordinary
Mark Type:
一系列商標 : NO
Series Mark:

[571] 商標描述 : N/A
Mark Description:

[730] 註冊申請人的姓名 / 名稱、地址 : CURIOO LIMITED
Applicant(s) ' Suite C, Level 7, World Trust Tower,
Name,Address: 50 Stanley Street, Central
HONG KONG

[740/ 註冊申請人的送達地址 : RIS GLOBAL INTERNATIONAL LIMITED
750] Applicant's Address for ROOM 1305, 13/F, WINFUL CENTRE
Service: 30 SHING YIP STREET, KWUN TONG
HONG KONG

[511] 類別編號 : 9,16,35,41,42
Class(es) No(s) .:

[511] 貨品 / 服務說明 : Class 42:
Specification: graphic arts design; cosmetic research;
computer programming; Design and development
of computer software; Development and creation
of computer programs for data processing;
technological research; web site design
consultancy; dress designing; material
testing; computer software design; Research in
the field of artificial intelligence
technology; Design and development of virtual
reality software

[526] 卸棄 : N/A
Disclaimer:

[529] 限制 : N/A
Limitation:

[527] 條件 : N/A
Condition:
其他 : N/A
Others

[220] 提交日期 : 22-01-2022
Date of Filing:

[320] 聲稱具有優先權的日期 : N/A
Date of Priority Claimed:

[310] 優先權申請編號 : N/A
Priority Application Number:

[340] 聲稱具有優先權 (部分) : N/A
Priority Claim Details:

[330] 優先權申請的
國家、地區、地方 : N/A
Country, territory, area of
Priority Applications:

[210] 商標申請編號 : 305866679
Application No.:

[540] 商標 :
Mark:



深空之眼
AETHER GAZER

[550] 商標種類 : 一般商標
Mark Type:
一系列商標 : 否
Series Mark:

[571] 商標描述 : 不適用
Mark Description:

[730] 註冊申請人的姓名 / 名稱、地址 : 廈門勇仕網絡技術股份有限公司
Applicant (s) ' 中國
Name, Address: 福建省廈門市
湖里區高林中路 535 號 701-713 單元

[740/ 註冊申請人的送達地址 : 滙誠知識產權有限公司
750] Applicant's Address for 香港
Service: 灣仔軒尼詩道 8-12 號
中港大廈 8 樓

[511] 類別編號 : 42
Class(es) No(s) .: 42

[511] 貨品 / 服務說明 : 類別 42:
Specification: 為他人研究和開發新產品 ; 多媒體設計 ; 材料測試 ; 計算機軟件維護 ; 計算機編程 ; 軟件即服務 (SaaS) ; 計算機軟件設計 ; 電子數據存儲 ; 服務器託管 ; 計算機軟件更新

[526] 卸棄 : 不適用
Disclaimer:

[529] 限制 : 不適用
Limitation:

[527] 條件 : 不適用
Condition:
其他 : 不適用
Others

[220] 提交日期 : 24-01-2022
Date of Filing:

[320] 聲稱具有優先權的日期 : 不適用
Date of Priority Claimed:

[310] 優先權申請編號 : 不適用
Priority Application Number:

[340] 聲稱具有優先權 (部分) : 不適用
Priority Claim Details:

[330] 優先權申請的 不適用
國家、地區、地方 :
Country, territory, area of
Priority Applications:

類別 Class 43

[210]	商標申請編號 : Application No.:	304529872
[540]	商標 : Mark:	
[550]	商標種類 : Mark Type:	Ordinary
	一系列商標 : Series Mark:	NO
[571]	商標描述 : Mark Description:	N/A
[730]	註冊申請人的姓名 / 名稱、地址 : Applicant(s) ' Name,Address:	Ocean Bay International Limited 海灣國際有限公司 11/F, TG Place, #10 Shing Yip Street, Kwun Tong, Hong Kong
[740/ 750]	註冊申請人的送達地址 : Applicant's Address for Service:	Ocean Bay International Limited 11/F, TG Place, No. 10 Shing Yip Street, Kwun Tong, KLN, Hong Kong
[511]	類別編號 : Class(es) No(s) .:	3, 9, 14, 16, 19, 20, 21, 24, 29, 30, 35, 37, 43
[511]	貨品 / 服務說明 : Specification:	Class 43: Provision of food or meals or drinks for take away; restaurant, café cafeteria, snack bar and coffee shop services; provision of food or meals or drinks for consumption; advisory services relating to the provision of food and drink; all included in Class 43.
[526]	卸棄 : Disclaimer:	N/A
[529]	限制 : Limitation:	N/A
[527]	條件 : Condition: 其他 : Others	N/A N/A
[220]	提交日期 : Date of Filing:	17-05-2018
[320]	聲稱具有優先權的日期 : Date of Priority Claimed:	N/A
[310]	優先權申請編號 : Priority Application Number:	N/A
[340]	聲稱具有優先權 (部分) : Priority Claim Details:	N/A
[330]	優先權申請的	N/A

國家、地區、地方：

Country, territory, area of
Priority Applications:

[210] 商標申請編號： 305131025
Application No.:
[540] 商標： A
Mark:



B



[550] 商標種類： Ordinary
Mark Type:
一系列商標： YES
Series Mark:
[571] 商標描述： N/A
Mark Description:
[730] 註冊申請人的姓名 / 名稱、地址： PERFECT (HK) CATERING COOPERATION LIMITED (元膳
Applicant(s) (香港) 飲食有限公司)
Name, Address: Shop 29A, Kam Sheung Road,
Pak Heung Sheung Tsuen, Yuen Long, NT,
HONG KONG

[740/ 註冊申請人的送達地址 : REG EASY INTELLECTUAL PROPERTY CO., LIMITED
750] Applicant's Address for 14/F, China Hong Kong Tower
Service: 8 Hennessy Road, Wan Chai
HONG KONG

[511] 類別編號 : 29,35,43
Class(es) No(s) .:

[511] 貨品 / 服務說明 : Class 43:
Specification: Services for providing food and drink;
temporary accommodation; Restaurant and
catering services; provision and preparations
of take-away food.

[526] 卸棄 : N/A
Disclaimer:

[529] 限制 : N/A
Limitation:

[527] 條件 : N/A
Condition:
其他 : By consent, No. 305103882
Others

[220] 提交日期 : 03-12-2019
Date of Filing:

[320] 聲稱具有優先權的日期 : N/A
Date of Priority Claimed:

[310] 優先權申請編號 : N/A
Priority Application Number:

[340] 聲稱具有優先權 (部分) : N/A
Priority Claim Details:

[330] 優先權申請的 N/A
國家、地區、地方 :
Country, territory, area of
Priority Applications:

[210] 商標申請編號 : 305208444
Application No.:

[540] 商標 :
Mark:



[550] 商標種類 : Ordinary
Mark Type:

- 一系列商標 : NO
Series Mark:
- [571] 商標描述 : The mark consists of a 3-dimensional shape of a building façade with the letter, numeral and word "K11 MUSEA" appearing on it.
Mark Description: The applicant claims the shape of the configuration of a building façade as an element of the trade mark.
- [730] 註冊申請人的姓名 / 名稱、地址 : NEW WORLD DEVELOPMENT COMPANY LIMITED
Applicant(s) ' Name,Address: 30th Floor, New World Tower,
18 Queen's Road Central,
HONG KONG
- [740/ 註冊申請人的送達地址 : HOGAN LOVELLS
750] Applicant's Address for 11th Floor, One Pacific Place
Service: 88 Queensway
HONG KONG
- [511] 類別編號 : 35,36,41,43
Class(es) No(s) .:
- [511] 貨品 / 服務說明 : Class 43:
Specification: Services for providing food and drink;
arranging and conducting of banquets; bar and cocktail lounge services; hotels; serviced apartments (temporary accommodation); guest house services; temporary accommodation; booking of restaurants, hotels, serviced apartments (temporary accommodation); catering services; charitable services, namely providing food, beverages or temporary accommodation; cocktail lounge buffets; coffee shop services; provision of food and drinks in a food court, food mall, fast food outlet, canteen, cafeteria, cafe, or restaurant; dim sum bars; dining and restaurant services; food and drink shops (other than retailing); food stores (other than retailing); operation of restaurants, bars, cafes and food stores; providing banquet and social function venues for special occasions; providing conference, exhibition and meeting venues; provision of booking and reservation services for accommodation and restaurants in relation to a loyalty program or incentive scheme; provision of facilities for conference and exhibitions; provision of food and beverages in relation to a loyalty program or incentive scheme; provision of information and advisory services relating to food stores (other than retailing); rental of meeting rooms; restaurant services for the provision of noodles, rice noodles, congee, dim sum, Chinese dishes, Chinese traditional pastries, drinks and desserts; snack and sandwich bar services; consultancy services relating to food, drink, catering, restaurant and cafeteria services; providing information relating to preparation of foods and beverages

and catering services on-line from a computer database or via the Internet or extranets; information, advisory and consultancy services relating to the aforesaid services.

- [526] 卸棄: N/A
Disclaimer:
- [529] 限制: N/A
Limitation:
- [527] 條件: N/A
Condition:
其他: By consent, Nos. 303599768, 304180725,
Others 304405112, 304587904 and 304670668.
- [220] 提交日期: 04-03-2020
Date of Filing:
- [320] 聲稱具有優先權的日期: N/A
Date of Priority Claimed:
- [310] 優先權申請編號: N/A
Priority Application Number:
- [340] 聲稱具有優先權 (部分): N/A
Priority Claim Details:
- [330] 優先權申請的
國家、地區、地方: N/A
Country, territory, area of
Priority Applications:
-
-

- [210] 商標申請編號: 305600349
Application No.:
- [540] 商標: **苏氏研创院**
Mark:
- [550] 商標種類: Ordinary
Mark Type:
一系列商標: NO
Series Mark:
- [571] 商標描述: N/A
Mark Description:
- [730] 註冊申請人的姓名 / 名稱、地址: Chimelong International Investment Company
Applicant(s) ' Limited
Name, Address: Vistra Corporate Services Centre, Wickhams Cay
II
Road Town, Tortola, VG1110
VIRGIN ISLANDS (BRITISH)
- [740/ 註冊申請人的送達地址: BENNY KONG & TSAI
750] Applicant's Address for Unit 19B, Overseas Trust Bank Building
Service: No. 160 Gloucester Road, Wanchai
HONG KONG

[511] 類別編號 : 39, 41, 42, 43
Class(es) No(s) :
[511] 貨品 / 服務說明 : Class 43:
Specification: Restaurant services; hotel accommodation services; tea house services; tourist home services; retirement home services; creche services; boarding for animals; rental of cooking apparatus; rental of Tableware; rental of lighting apparatus

[526] 卸棄 : N/A
Disclaimer:
[529] 限制 : N/A
Limitation:
[527] 條件 : N/A
Condition:
其他 : N/A
Others

[220] 提交日期 : 21-04-2021
Date of Filing:
[320] 聲稱具有優先權的日期 : N/A
Date of Priority Claimed:
[310] 優先權申請編號 : N/A
Priority Application Number:
[340] 聲稱具有優先權 (部分) : N/A
Priority Claim Details:
[330] 優先權申請的
國家、地區、地方 : N/A
Country, territory, area of
Priority Applications:

[210] 商標申請編號 : 305613543
Application No.:

[540] 商標 :
Mark:

LELLOBEE

[550] 商標種類 : Ordinary
Mark Type:
一系列商標 : NO
Series Mark:

[571] 商標描述 : N/A
Mark Description:

[730] 註冊申請人的姓名 / 名稱、地址 : Moonbug Entertainment Limited
Applicant(s) ' Labs Upper Lock 2nd Floor 3-6 Water Lane
Name, Address: Camden Town London NW1 8JZ
UNITED KINGDOM

[740/ 註冊申請人的送達地址 : BENNY KONG & TSAI
750] Applicant's Address for Unit 19B, Overseas Trust Bank Building
Service: No. 160 Gloucester Road, Wanchai
HONG KONG

[511] 類別編號 : 3, 5, 8, 9, 10, 11, 12, 14, 15, 16, 18, 20, 21, 24, 25, 26, 27
Class(es) No(s) : , 28, 29, 30, 32, 35, 41, 42, 43

[511] 貨品 / 服務說明 : Class 43:
Specification: Services for providing food and drink;
temporary accommodation; restaurants; cafés.

[526] 卸棄 : N/A
Disclaimer:

[529] 限制 : N/A
Limitation:

[527] 條件 : N/A
Condition:
其他 : N/A
Others

[220] 提交日期 : 03-05-2021
Date of Filing:

[320] 聲稱具有優先權的日期 : N/A
Date of Priority Claimed:

[310] 優先權申請編號 : N/A
Priority Application Number:

[340] 聲稱具有優先權 (部分) : N/A
Priority Claim Details:

[330] 優先權申請的 : N/A
國家、地區、地方 :
Country, territory, area of
Priority Applications:

[210] 商標申請編號 : 305614524
Application No.:

[540] 商標 : A **HENDERSON LAND**
Mark: B **HENDERSON LAND**

[550] 商標種類 : Ordinary
Mark Type:
一系列商標 : YES
Series Mark:

[571] 商標描述 : N/A
Mark Description:

[730] 註冊申請人的姓名 / 名稱、地址 : Henderson Development Limited
Applicant(s) ' 72-76/F, Two International Finance Centre,
Name, Address: 8 Finance Street, Central,
HONG KONG

[740/ 註冊申請人的送達地址 : WOO KWAN LEE & LO
750] Applicant's Address for Room 2801, Sun Hung Kai Centre,
Service: 30 Harbour Road, Wanchai
HONG KONG
[511] 類別編號 : 35, 36, 37, 41, 43, 44
Class(es) No(s) .: Class 43:
[511] 貨品 / 服務說明 : Services for providing food and drink;
Specification: temporary accommodation; hotel services and
hotel operation; serviced apartment, serviced
suite and temporary accommodation services;
restaurant and catering services; provision of
resort and conference facilities; all included
in Class 43.
[526] 卸棄 : N/A
Disclaimer:
[529] 限制 : N/A
Limitation:
[527] 條件 : N/A
Condition:
其他 : By consent, Nos. 300139464, 303139759,
Others 303682990, 303683007, 303683016, 303683025,
303683034, 303683043, 303683052, 304240773,
305169628, 305169646, 305461164 and 305519386
[220] 提交日期 : 04-05-2021
Date of Filing:
[320] 聲稱具有優先權的日期 : N/A
Date of Priority Claimed:
[310] 優先權申請編號 : N/A
Priority Application Number:
[340] 聲稱具有優先權 (部分) : N/A
Priority Claim Details:
[330] 優先權申請的 N/A
國家、地區、地方 :
Country, territory, area of
Priority Applications:

[210] 商標申請編號 : 305614533
Application No.:

[540] 商標 : A HENDERSON LAND
Mark: 恒基兆業地產
B HENDERSON LAND
恒基兆業地產

C HENDERSON LAND
 恒基兆業地產
 D HENDERSON LAND
 恒基兆業地產

- [550] 商標種類 : Ordinary
 Mark Type:
 一系列商標 : YES
 Series Mark:
- [571] 商標描述 : N/A
 Mark Description:
- [730] 註冊申請人的姓名 / 名稱、地址 : Henderson Development Limited
 Applicant(s) ' 72-76/F, Two International Finance Centre,
 Name, Address: 8 Finance Street, Central,
 HONG KONG
- [740/ 註冊申請人的送達地址 : WOO KWAN LEE & LO
 750] Applicant's Address for Room 2801, Sun Hung Kai Centre,
 Service: 30 Harbour Road, Wanchai
 HONG KONG
- [511] 類別編號 : 35, 36, 37, 41, 43, 44
 Class(es) No(s) .:
- [511] 貨品 / 服務說明 : Class 43:
 Specification: Services for providing food and drink;
 temporary accommodation; hotel services and
 hotel operation; serviced apartment, serviced
 suite and temporary accommodation services;
 restaurant and catering services; provision of
 resort and conference facilities; all included
 in Class 43.
- [526] 卸棄 : N/A
 Disclaimer:
- [529] 限制 : N/A
 Limitation:
- [527] 條件 : N/A
 Condition:
 其他 : By consent, Nos. 300139464, 303139759,
 Others 303682990, 303683007, 303683016, 303683025,
 303683034, 303683043, 303683052, 304240773,
 305169628, 305169637, 305169646, 305169655,
 305461164 and 305519386
- [220] 提交日期 : 04-05-2021
 Date of Filing:
- [320] 聲稱具有優先權的日期 : N/A
 Date of Priority Claimed:
- [310] 優先權申請編號 : N/A
 Priority Application Number:
- [340] 聲稱具有優先權 (部分) : N/A
 Priority Claim Details:
- [330] 優先權申請的 : N/A
 國家、地區、地方 :

Country, territory, area of
Priority Applications:

[210] 商標申請編號 : 305645043AB
Application No.:
[540] 商標 : A
Mark:



B



[550] 商標種類 : Ordinary
Mark Type:
一系列商標 : YES
Series Mark:
[571] 商標描述 : N/A
Mark Description:
[730] 註冊申請人的姓名 / 名稱、地址 : Kloud Management Company Limited
Applicant(s)' 25/F, Devon House, Taikoo Place
Name,Address: 979 King's Road, Quarry Bay
HONG KONG
[740/ 註冊申請人的送達地址 : HOGAN LOVELLS
750] Applicant's Address for 11th Floor, One Pacific Place
Service: 88 Queensway
HONG KONG

- [511] 類別編號 : 29, 30, 43
Class(es) No(s) .:
- [511] 貨品 / 服務說明 :
Specification: Class 43:
Services for providing food and drink; café services; cafeteria services; canteen services; restaurant services; catering services; self-service restaurant services; snack-bar services; bar services; delicatessen (restaurants); fast food restaurant services; food and beverage services for dine-in, takeaway and home delivery; mobile catering services; mobile shops for provision of food and drink; provision of take-away or delivery food ordered by telephone or facsimile or through an online platform; providing of information and news in the field of providing food, drink, catering and restaurants via an online platform; reservation services for restaurants and meals; temporary accommodation.
- [526] 卸棄 : N/A
Disclaimer:
- [529] 限制 : N/A
Limitation:
- [527] 條件 : N/A
Condition:
其他 : N/A
Others
- [220] 提交日期 : 02-06-2021
Date of Filing:
- [320] 聲稱具有優先權的日期 : N/A
Date of Priority Claimed:
- [310] 優先權申請編號 : N/A
Priority Application Number:
- [340] 聲稱具有優先權 (部分) : N/A
Priority Claim Details:
- [330] 優先權申請的
國家、地區、地方 : N/A
Country, territory, area of
Priority Applications:
-
-

- [210] 商標申請編號 : 305645098AB
Application No.:

[540] 商標 :
Mark:

A



B



[550] 商標種類 : Ordinary
Mark Type:
一系列商標 : YES
Series Mark:
[571] 商標描述 : N/A
Mark Description:
[730] 註冊申請人的姓名 / 名稱、地址 : Kloud Management Company Limited
Applicant(s) ' 25/F, Devon House, Taikoo Place
Name,Address: 979 King's Road, Quarry Bay
HONG KONG
[740/ 註冊申請人的送達地址 : HOGAN LOVELLS
750] Applicant's Address for 11th Floor, One Pacific Place
Service: 88 Queensway
HONG KONG
[511] 類別編號 : 35,43
Class(es) No(s) .:
[511] 貨品 / 服務說明 : Class 43:
Specification: Services for providing food and drink; café services; cafeteria services; canteen services; restaurant services; catering services; self-service restaurant services; snack-bar services; bar services; delicatessen

(restaurants); fast food restaurant services; food and beverage services for dine-in, takeaway and home delivery; mobile catering services; mobile shops for provision of food and drink; provision of take-away or delivery food ordered by telephone or facsimile or through an online platform; providing of information and news in the field of providing food, drink, catering and restaurants via an online platform; reservation services for restaurants and meals; temporary accommodation.

[526] 卸棄:	N/A
Disclaimer:	
[529] 限制:	N/A
Limitation:	
[527] 條件:	N/A
Condition:	
其他:	N/A
Others	
[220] 提交日期:	02-06-2021
Date of Filing:	
[320] 聲稱具有優先權的日期:	N/A
Date of Priority Claimed:	
[310] 優先權申請編號:	N/A
Priority Application Number:	
[340] 聲稱具有優先權 (部分):	N/A
Priority Claim Details:	
[330] 優先權申請的	N/A
國家、地區、地方:	
Country, territory, area of	
Priority Applications:	



[210] 商標申請編號:	305648815
Application No.:	

[540] 商標 :
Mark:



KUSHIRO

[550] 商標種類 : Ordinary
Mark Type:
一系列商標 : NO
Series Mark:
[571] 商標描述 : N/A
Mark Description:
[730] 註冊申請人的姓名 / 名稱、地址 : Kai Shun Hong Trading Limited (佳信行貿易有限公司)
Applicant(s) ')
Name,Address: Shop BW1, BW3 & BW5, B1/F, The Peninsula Hotel,
Salisbury Road, Tsim Sha Tsui, Kowloon,
HONG KONG
[740/ 註冊申請人的送達地址 : ACCOLADE IP LIMITED
750] Applicant's Address for 10/F, Fu Fai Comm. Ctr.,
Service: 27 Hillier Street, Sheung Wan,
HONG KONG
[511] 類別編號 : 43
Class(es) No(s) :
[511] 貨品 / 服務說明 : Class 43:
Specification: Restaurants; self-service restaurants;
catering and takeaway services; washoku
restaurant services; Japanese restaurants;
Teppanyaki restaurants; seafood, sushi and
sashimi bar; bars; pubs; Izakaya (Japanese
style pub restaurant); snack bar services;
preparation and provision of meals, food and
beverages for dine-in or takeaway; provision
of food and drink; preparation and provision
of take-away or delivery food and drink
ordered by telephone or facsimile, mobile
applications, online websites and the
Internet; providing information relating to
the aforesaid online via the internet, online
websites, social media websites; all the
aforesaid services included in Class 43.
[526] 卸棄 : N/A
Disclaimer:

[529] 限制 :	N/A
Limitation:	
[527] 條件 :	N/A
Condition:	
其他 :	N/A
Others	
[220] 提交日期 :	07-06-2021
Date of Filing:	
[320] 聲稱具有優先權的日期 :	N/A
Date of Priority Claimed:	
[310] 優先權申請編號 :	N/A
Priority Application Number:	
[340] 聲稱具有優先權 (部分) :	N/A
Priority Claim Details:	
[330] 優先權申請的 國家、地區、地方 :	N/A
Country, territory, area of Priority Applications:	
<hr/>	
[210] 商標申請編號 :	305683951
Application No.:	
[540] 商標 :	
Mark:	
[550] 商標種類 :	一般商標
Mark Type:	
一系列商標 :	否
Series Mark:	
[571] 商標描述 :	不適用
Mark Description:	
[730] 註冊申請人的姓名 / 名稱、地址 :	I TAE WON KOREAN RESTAURANT LIMITED
Applicant(s) ' Name,Address:	SHOP 18A G/F KIU FUNG MANSION NO.14-18C AUSTIN AVENUE TSIM SHA TSUI KL HONG KONG
[740/ 註冊申請人的送達地址 :	卓遠知識產權有限公司
750] Applicant's Address for Service:	香港 上環禧利街 27 號 富輝商業中心 10 樓
[511] 類別編號 :	43
Class(es) No(s) .:	
[511] 貨品 / 服務說明 :	類別 43:
Specification:	餐飲服務

- [526] 卸棄: 不適用
Disclaimer:
- [529] 限制: 不適用
Limitation:
- [527] 條件: 不適用
Condition:
其他: 不適用
Others
- [220] 提交日期: 13-07-2021
Date of Filing:
- [320] 聲稱具有優先權的日期: 不適用
Date of Priority Claimed:
- [310] 優先權申請編號: 不適用
Priority Application Number:
- [340] 聲稱具有優先權 (部分): 不適用
Priority Claim Details:
- [330] 優先權申請的
國家、地區、地方: 不適用
Country, territory, area of
Priority Applications:
-
-

- [210] 商標申請編號: 305700960
Application No.:
- [540] 商標: A
Mark:



B



- [550] 商標種類 : Ordinary
 Mark Type:
- 一系列商標 : YES
 Series Mark:
- [571] 商標描述 : N/A
 Mark Description:
- [730] 註冊申請人的姓名 / 名稱、地址 : Lai Sun Dining Limited
 Applicant(s) ' 11/F, Lai Sun Commercial Centre,
 Name,Address: 680 Cheung Sha Wan Road, Kowloon,
 HONG KONG
- [740/ 註冊申請人的送達地址 : MAYER BROWN
 750] Applicant's Address for 16th-19th Floors, Prince's Building
 Service: 10 Chater Road, Central
 HONG KONG
- [511] 類別編號 : 43
 Class(es) No(s) .:
- [511] 貨品 / 服務說明 : Class 43:
 Specification: Restaurant services; café and bar services;
 cocktail lounge services; catering services;
 night club catering services; services for
 providing food and drink; preparation of foods
 and meals for take away.
- [526] 卸棄 : N/A
 Disclaimer:
- [529] 限制 : N/A
 Limitation:
- [527] 條件 : N/A
 Condition:
 其他 : N/A
 Others
- [220] 提交日期 : 28-07-2021
 Date of Filing:
- [320] 聲稱具有優先權的日期 : N/A
 Date of Priority Claimed:
- [310] 優先權申請編號 : N/A
 Priority Application Number:
- [340] 聲稱具有優先權 (部分) : N/A

Priority Claim Details:

[330] 優先權申請的 N/A
 國家、地區、地方：
 Country, territory, area of
 Priority Applications:

[210] 商標申請編號： 305712697
 Application No.:

[540] 商標：
 Mark:

A  HENDERSON LAND DEVELOPMENT COMPANY LIMITED
 恒基兆業地產有限公司

B  HENDERSON LAND DEVELOPMENT COMPANY LIMITED
 恒基兆業地產有限公司

C  HENDERSON LAND DEVELOPMENT COMPANY LIMITED
 恒基兆業地產有限公司

D  HENDERSON LAND DEVELOPMENT COMPANY LIMITED
 恒基兆業地產有限公司

[550] 商標種類： Ordinary
 Mark Type:
 一系列商標： YES
 Series Mark:

[571] 商標描述： N/A
 Mark Description:

[730] 註冊申請人的姓名 / 名稱、地址：
 Applicant(s)'
 Name, Address: Henderson Development Limited
 72-76/F, Two International Finance Centre,
 8 Finance Street, Central,
 HONG KONG

[740/ 註冊申請人的送達地址：
 750] Applicant's Address for
 Service: WOO KWAN LEE & LO
 Room 2801, Sun Hung Kai Centre,
 30 Harbour Road, Wanchai
 HONG KONG

[511] 類別編號： 35, 36, 37, 41, 43, 44
 Class(es) No(s) .:

[511] 貨品 / 服務說明：
 Specification: Class 43:
 Services for providing food and drink;
 temporary accommodation; hotel services and
 hotel operation; serviced apartment, serviced
 suite and temporary accommodation services;
 restaurant and catering services; provision of
 resort and conference facilities; all included
 in Class 43.

[526] 卸棄： N/A
 Disclaimer:

[529] 限制： N/A
 Limitation:

[527] 條件： N/A
 Condition:
 其他：
 Others By consent, Nos. 300139464, 300517743,
 303139759, 303682990, 303683007, 303683016,
 303683025, 303683034, 303683043, 303683052,

304240773, 305169628, 305169637, 305169646,
305169655, 305461164 and 305519386

[220] 提交日期: 10-08-2021

Date of Filing:

[320] 聲稱具有優先權的日期: N/A

Date of Priority Claimed:

[310] 優先權申請編號: N/A

Priority Application Number:

[340] 聲稱具有優先權 (部分): N/A

Priority Claim Details:

[330] 優先權申請的 N/A

國家、地區、地方:

Country, territory, area of
Priority Applications:

[210] 商標申請編號: 305712705

Application No.:

[540] 商標:

Mark:

A



HENDERSON LAND GROUP

恒基兆業地產集團

B



HENDERSON LAND GROUP

恒基兆業地產集團

C



HENDERSON LAND GROUP

恒基兆業地產集團

D



HENDERSON LAND GROUP

恒基兆業地產集團

[550] 商標種類: Ordinary

Mark Type:

一系列商標:

YES

Series Mark:

[571] 商標描述: N/A

Mark Description:

[730] 註冊申請人的姓名 / 名稱、地址:

Applicant(s)'

Name, Address:

Henderson Development Limited
72-76/F, Two International Finance Centre,
8 Finance Street, Central,
HONG KONG

[740/ 註冊申請人的送達地址:

750] Applicant's Address for
Service:WOO KWAN LEE & LO
Room 2801, Sun Hung Kai Centre,
30 Harbour Road, Wanchai
HONG KONG

[511] 類別編號: 35, 36, 37, 41, 43, 44

Class(es) No(s) .:

- [511] 貨品 / 服務說明 :
Specification: Class 43:
Services for providing food and drink;
temporary accommodation; hotel services and
hotel operation; serviced apartment, serviced
suite and temporary accommodation services;
restaurant and catering services; provision of
resort and conference facilities; all included
in Class 43.
- [526] 卸棄 :
Disclaimer: N/A
- [529] 限制 :
Limitation: N/A
- [527] 條件 :
Condition: N/A
其他 :
Others By consent, Nos. 300139464, 300517743,
303139759, 303682990, 303683007, 303683016,
303683025, 303683034, 303683043, 303683052,
304240773, 305169628, 305169637, 305169646,
305169655, 305461164 and 305519386
- [220] 提交日期 :
Date of Filing: 10-08-2021
- [320] 聲稱具有優先權的日期 :
Date of Priority Claimed: N/A
- [310] 優先權申請編號 :
Priority Application Number: N/A
- [340] 聲稱具有優先權 (部分) :
Priority Claim Details: N/A
- [330] 優先權申請的
國家、地區、地方 :
Country, territory, area of
Priority Applications: N/A

- [210] 商標申請編號 :
Application No.: 305733171

- [540] 商標 :
Mark:



- [550] 商標種類 :
Mark Type: Ordinary
一系列商標 :
Series Mark: NO
- [571] 商標描述 :
Mark Description: N/A
- [730] 註冊申請人的姓名 / 名稱、地址 :
Applicant(s) ' Name,Address: Aston Martin Lagonda Limited
Banbury Road, Gaydon,
Warwick CV35 0DB
UNITED KINGDOM

- [740/ 註冊申請人的送達地址 : SIMONE INTELLECTUAL PROPERTY SERVICES ASIA
750] Applicant's Address for LIMITED
Service: 25th Floor, 3 Lockhart Road,
Wanchai,
HONG KONG
- [511] 類別編號 : 3, 6, 7, 8, 9, 12, 14, 16, 18, 20, 21, 24, 25, 27, 28, 33, 34,
Class(es) No(s) : 35, 36, 37, 39, 40, 41, 42, 43
- [511] 貨品 / 服務說明 : Class 43:
Specification: Temporary accommodation services; hotel, bed
and breakfast, resort services; providing
holiday and tourist accommodation; provision
of food and drink; hospitality services;
corporate hospitality services; reservation
services for booking temporary accommodation,
holiday accommodation, restaurants, bars;
provision of event facilities; sommelier
services; provision of information, advisory
and consultancy services in relation to the
aforesaid services.
- [526] 卸棄 : N/A
Disclaimer:
- [529] 限制 : N/A
Limitation:
- [527] 條件 : N/A
Condition:
其他 : N/A
Others
- [220] 提交日期 : 31-08-2021
Date of Filing:
- [320] 聲稱具有優先權的日期 : 01-03-2021
Date of Priority Claimed:
- [310] 優先權申請編號 : 82787
Priority Application Number:
- [340] 聲稱具有優先權 (部分) : for goods listed in "A" in Classes 9 and 12
Priority Claim Details: and for all goods and services in Classes 3,
6, 7, 8, 14, 16, 18, 20, 21, 24, 25, 27, 28,
33, 34, 35, 36, 37, 39, 40, 41, 42 and 43
- [330] 優先權申請的 JAMAICA
國家、地區、地方 :
Country, territory, area of
Priority Applications:
-
-

- [210] 商標申請編號 : 305733180
Application No.:

- [540] 商標 :
Mark:



- [550] 商標種類 : Ordinary
Mark Type:
一系列商標 : NO
Series Mark:
- [571] 商標描述 : N/A
Mark Description:
- [730] 註冊申請人的姓名 / 名稱、地址 : Aston Martin Lagonda Limited
Applicant(s) ' Banbury Road, Gaydon,
Name,Address: Warwick CV35 0DB
UNITED KINGDOM
- [740/ 註冊申請人的送達地址 : SIMONE INTELLECTUAL PROPERTY SERVICES ASIA
750] Applicant's Address for LIMITED
Service: 25th Floor, 3 Lockhart Road,
Wanchai,
HONG KONG
- [511] 類別編號 : 3, 6, 7, 8, 9, 12, 14, 16, 18, 20, 21, 24, 25, 27, 28, 33, 34,
Class(es) No(s) .: 35, 36, 37, 39, 40, 41, 42, 43
- [511] 貨品 / 服務說明 : Class 43:
Specification: Temporary accommodation services; hotel, bed
and breakfast, resort services; providing
holiday and tourist accommodation; provision
of food and drink; hospitality services;
corporate hospitality services; reservation
services for booking temporary accommodation,
holiday accommodation, restaurants, bars;
provision of event facilities; sommelier
services; provision of information, advisory
and consultancy services in relation to the
aforesaid services.
- [526] 卸棄 : N/A
Disclaimer:
- [529] 限制 : N/A
Limitation:
- [527] 條件 : N/A
Condition:
其他 : N/A
Others
- [220] 提交日期 : 31-08-2021
Date of Filing:
- [320] 聲稱具有優先權的日期 : 01-03-2021
Date of Priority Claimed:
- [310] 優先權申請編號 : 82788
Priority Application Number:
- [340] 聲稱具有優先權 (部分) : for goods listed in "A" in Classes 9 and 12
Priority Claim Details: and for all goods and services in Classes 3,
6, 7, 8, 14, 16, 18, 20, 21, 24, 25, 27, 28,
33, 34, 35, 36, 37, 39, 40, 41, 42 and 43
- [330] 優先權申請的 JAMAICA
國家、地區、地方 :
Country, territory, area of
Priority Applications:

[210] 商標申請編號 : 305751586

Application No.:

[540] 商標 :

Mark:



majUP

[550] 商標種類 : Ordinary

Mark Type:

一系列商標 :

NO

Series Mark:

[571] 商標描述 :

Mark Description:

The applicant claims the colours blue, white and turquoise as elements of the trade mark.

[730] 註冊申請人的姓名 / 名稱、地址 :

Applicant(s) ' Name,Address:

Majorel Berlin GmbH

Wohlrabedamm 32

13629 Berlin

GERMANY

[740/ 註冊申請人的送達地址 :

Applicant's Address for Service:

DEACONS

5th Floor,

Alexandra House Central

HONG KONG

[511] 類別編號 :

Class(es) No(s) .:

9, 35, 36, 38, 39, 41, 42, 43, 45

[511] 貨品 / 服務說明 :

Specification:

Class 43:

Booking of accommodation for travelers;

Reception services in the field of temporary

accommodation [arrival and departure

management]; Rental of guest rooms; Rental of

meeting rooms.

[526] 卸棄 :

Disclaimer:

N/A

[529] 限制 :

Limitation:

N/A

[527] 條件 :

Condition:

N/A

其他 :

Others

N/A

[220] 提交日期 :

Date of Filing:

20-09-2021

[320] 聲稱具有優先權的日期 : 19-03-2021
Date of Priority Claimed:

[310] 優先權申請編號 : 302021006047
Priority Application Number:

[340] 聲稱具有優先權 (部分) : N/A
Priority Claim Details:

[330] 優先權申請的
國家、地區、地方 : GERMANY
Country, territory, area of
Priority Applications:

[210] 商標申請編號 : 305794930
Application No.:

[540] 商標 :
Mark:

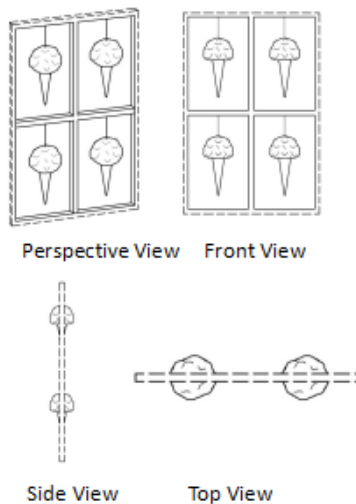

[550] 商標種類 : Ordinary
Mark Type:

一系列商標 : NO
Series Mark:

[571] 商標描述 : The Mark consists of a 3-Dimensional shape.
Mark Description: The applicant claims the shape of a frame consisting of four squares with an ice cream hanging from each square as an element of the trade mark.

[730] 註冊申請人的姓名 / 名稱、地址 : Venchi S.p.A.
Applicant(s) ' Via Venchi 1,
Name, Address: 2040 Castelletto Stura CN
ITALY

[740/ 註冊申請人的送達地址 : C&H IP LAW LIMITED
750] Applicant's Address for 8/F., China Hong Kong Tower,
Service: 8-12 Hennessy Road, Wan Chai
HONG KONG

[511] 類別編號 : 35, 43
Class(es) No(s) .:

[511] 貨品 / 服務說明 : Class 43:
Specification: Restaurant services; restaurant services for preparing and serving ice cream; services for providing food and drink; café services; bar and restaurant services.

[526] 卸棄 : N/A
Disclaimer:

[529] 限制 : N/A
Limitation:

[527] 條件 : N/A
Condition:
其他 : N/A
Others

[220] 提交日期 : 08-11-2021
Date of Filing:

[320] 聲稱具有優先權的日期 : N/A
Date of Priority Claimed:

[310] 優先權申請編號 : N/A
Priority Application Number:

[340] 聲稱具有優先權 (部分) : N/A
Priority Claim Details:

[330] 優先權申請的
國家、地區、地方 : N/A
Country, territory, area of
Priority Applications:

[210] 商標申請編號 : 305797838
Application No.:

[540] 商標 :
Mark:

BIG YARD

[550] 商標種類 : Ordinary
Mark Type:
一系列商標 : NO
Series Mark:

[571] 商標描述 : N/A
Mark Description:

[730] 註冊申請人的姓名 / 名稱、地址 : WILLAROOS LTD
Applicant(s) ' 9-10 Plowright Place Swaffham
Name, Address: PE37 7LQ

[740/ 註冊申請人的送達地址 : UNITED KINGDOM
750] Applicant's Address for BIRD & BIRD
Service: 6/F, The Annex, Central Plaza
18 Harbour Road
HONG KONG

- [511] 類別編號 : 29,30,43
Class(es) No(s) .:
- [511] 貨品／服務說明 :
Specification:
- Class 43:
Provision of a dark kitchen; Street food market stall; Restaurant services; Catering services; Catering services for private events; Food and drink catering; Mobile catering services; Off-premises catering services; Outside catering services; Catering services for the provision of food and drink; Services for providing food and drink; Providing food and drink catering services for music events, concerts, music gigs, trade shows, conventions and exhibitions; Business catering services; Consultancy services in the field of food and drink catering; Preparation of food and drink; Preparation of food and drink for consumption on the premises; Preparation of food and drink for consumption off the premises; Restaurant, bar, wine bar, takeaway, cafe, cafeteria, canteen, coffee shop and snack-bar services; Restaurant services incorporating licensed bar facilities; Self-service restaurants; Fast food takeaways; Fast food restaurants; Quick service restaurants; Food and drink takeaway services; Banqueting and catering services; Booking and reservation services; Providing food and drinks via mobile truck; Restaurant services provided via mobile food carts; Pop-up street food restaurant and catering services; Provision of food and drink served via a food truck; Advice concerning cooking recipes; information services relating to all the aforesaid services; Hiring of event space; Rental of event space; Food kiosk services being services for providing food and drink; Takeaway food services; Takeaway food and drink services; Serving food and drink in retail and takeaway establishments; Click & collect food takeaway services; Pre-ordered food takeaway services; Consulting in the field of menu planning for others; Providing information in the fields of food and beverage preparation, cooking, recipes, ingredients, and cookware techniques via a website on global computer networks; Providing personalised meal planning services via a website; Advice concerning cooking recipes; Providing information in the nature of recipes for drinks.
- [526] 卸棄 : N/A
Disclaimer:
- [529] 限制 : N/A
Limitation:

[527] 條件 :	N/A		
Condition:			
其他 :	N/A		
Others			
[220] 提交日期 :	10-11-2021		
Date of Filing:			
[320] 聲稱具有優先權的日期 :	[310] 優先權申請編號 :	[340] 聲稱具有優先權 (部分) :	[330] 優先權申請的
Date of Priority Claimed:	Priority Application No.:	Priority Claim Details:	國家、地區、地方 :
			Country, territory, area of Priority Applications:
15-09-2021	3694910	For Class 43 and goods listed in (A) in Classes 29 and 30.	UNITED KINGDOM
04-11-2021	3717980	For goods listed in (B) in Classes 29 and 30.	UNITED KINGDOM

[210] 商標申請編號 : 305816467
Application No.:

[540] 商標 : A
Mark:



E N S Ō

B



- [550] 商標種類 : Ordinary
 Mark Type:
 一系列商標 : YES
 Series Mark:
- [571] 商標描述 : The applicant claims the colour black as an element of mark "A" in the series and the colour white as an element of mark "B" in the series.
 Mark Description:
- [730] 註冊申請人的姓名 / 名稱、地址 : Wong Renee trading as ENSO
 Applicant(s) ' Name,Address: A1, 1/F, Block A, Tonic Industrial Centre 26 Kai Cheung Road, Kowloon Bay Kowloon, HONG KONG
- [740/ 註冊申請人的送達地址 : Wong Renee
 750] Applicant's Address for Service: A1, 1/F, Block A, Tonic Industrial Centre 26 Kai Cheung Road, Kowloon Bay HONG KONG
- [511] 類別編號 : 43
 Class(es) No(s) .:
- [511] 貨品 / 服務說明 : Class 43:
 Specification: Services for providing food and drink
- [526] 卸棄 : N/A
 Disclaimer:
- [529] 限制 : N/A
 Limitation:
- [527] 條件 : N/A
 Condition:
 其他 : N/A
 Others
- [220] 提交日期 : 30-11-2021
 Date of Filing:
- [320] 聲稱具有優先權的日期 : N/A
 Date of Priority Claimed:
- [310] 優先權申請編號 : N/A
 Priority Application Number:
- [340] 聲稱具有優先權 (部分) : N/A

Priority Claim Details:

[330] 優先權申請的 N/A
國家、地區、地方：
Country, territory, area of
Priority Applications:

[210] 商標申請編號： 305824882
Application No.:

[540] 商標： A K O U D A
Mark: B K O U D A
C K o u d a
D k o u d a

[550] 商標種類： Ordinary
Mark Type:
一系列商標： YES
Series Mark:

[571] 商標描述： N/A
Mark Description:

[730] 註冊申請人的姓名 / 名稱、地址： TIMBIRD INTERNATIONAL LIMITED
Applicant(s) ' Vistra Corporate Services Centre,
Name,Address: Wickhams Cay II, Road Town, Tortola, VG1110,
VIRGIN ISLANDS (BRITISH)

[740/ 註冊申請人的送達地址： MAYER BROWN
750] Applicant's Address for 16th-19th Floors, Prince's Building,
Service: 10 Chater Road, Central,
HONG KONG

[511] 類別編號： 43
Class(es) No(s) .:

[511] 貨品 / 服務說明： Class 43:
Specification: Services for providing food and drink; bar
services; cafés; cafeterias; coffee-shop
services; canteens; bakery and catering
services; restaurants; Japanese restaurants;
restaurants serving Japanese food; ice cream
shop services; confectioner's shop services;
delicatessen shop services; snack-bars;
catering services provided online from a

computer database or from the Internet; information relating to food, drink and catering services provided online from a computer database or from the Internet; providing of catering information by text and images in the field of food, drink and catering via a website; temporary accommodation; restaurants, bars, bakeries, coffee shops, lounges, self-service and buffet restaurants; bar, cafe, cafeteria, snack bar, coffee-shop, restaurant, bakery and catering services; cocktail lounge services; providing information relating to restaurant and bar services on-line from a computer database or via the Internet or extranets; provision of information relating to restaurant and bar services; restaurant reservation services; provision of dine-in and take-away catering services; provision of restaurant, self-service restaurant, buffet restaurant, fast food restaurant, coffee shop, canteen, catering, tea house, bakery and banqueting services; hotel, motel and guest house accommodation services; temporary accommodation reservation services; providing facilities for exhibitions, conferences and trade fairs; consultancy, advisory and information services relating to the aforesaid services.

- [526] 卸棄 : N/A
Disclaimer:
- [529] 限制 : N/A
Limitation:
- [527] 條件 : N/A
Condition:
其他 : N/A
Others
- [220] 提交日期 : 07-12-2021
Date of Filing:
- [320] 聲稱具有優先權的日期 : N/A
Date of Priority Claimed:
- [310] 優先權申請編號 : N/A
Priority Application Number:
- [340] 聲稱具有優先權 (部分) : N/A
Priority Claim Details:
- [330] 優先權申請的 : N/A
國家、地區、地方 :
Country, territory, area of
Priority Applications:

[210] 商標申請編號 : 305824909
Application No.:

[540] 商標 : A
Mark:

香

田

B

香

田

C

香 田

[550] 商標種類 : Ordinary

Mark Type:

一系列商標 : YES

Series Mark:

[571] 商標描述 : N/A

Mark Description:

[730] 註冊申請人的姓名 / 名稱、地址 :

Applicant(s)'

Name,Address:

TIMBIRD INTERNATIONAL LIMITED
Vistra Corporate Services Centre,
Wickhams Cay II, Road Town, Tortola, VG1110,
VIRGIN ISLANDS (BRITISH)

[740/ 註冊申請人的送達地址 :
750] Applicant's Address for Service: MAYER BROWN
16th-19th Floors, Prince's Building,
10 Chater Road, Central,
HONG KONG

[511] 類別編號 :
Class(es) No(s) .: 43

[511] 貨品 / 服務說明 :
Specification: Class 43:
Services for providing food and drink; bar services; cafés; cafeterias; coffee-shop services; canteens; bakery and catering services; restaurants; Japanese restaurants; restaurants serving Japanese food; ice cream shop services; confectioner's shop services; delicatessen shop services; snack-bars; catering services provided online from a computer database or from the Internet; information relating to food, drink and catering services provided online from a computer database or from the Internet; providing of catering information by text and images in the field of food, drink and catering via a website; temporary accommodation; restaurants, bars, bakeries, coffee shops, lounges, self-service and buffet restaurants; bar, cafe, cafeteria, snack bar, coffee-shop, restaurant, bakery and catering services; cocktail lounge services; providing information relating to restaurant and bar services on-line from a computer database or via the Internet or extranets; provision of information relating to restaurant and bar services; restaurant reservation services; provision of dine-in and take-away catering services; provision of restaurant, self-service restaurant, buffet restaurant, fast food restaurant, coffee shop, canteen, catering, tea house, bakery and banqueting services; hotel, motel and guest house accommodation services; temporary accommodation reservation services; providing facilities for exhibitions, conferences and trade fairs; consultancy, advisory and information services relating to the aforesaid services.

[526] 卸棄 :
Disclaimer: N/A

[529] 限制 :
Limitation: N/A

[527] 條件 :
Condition: N/A

其他 :
Others N/A

[220] 提交日期 :
Date of Filing: 07-12-2021

[320] 聲稱具有優先權的日期 :
N/A

Date of Priority Claimed:

[310] 優先權申請編號: N/A

Priority Application Number:

[340] 聲稱具有優先權 (部分): N/A

Priority Claim Details:

[330] 優先權申請的 N/A

國家、地區、地方:

Country, territory, area of

Priority Applications:

[210] 商標申請編號: 305827078

Application No.:

[540] 商標: A

Mark:



B



[550] 商標種類: Ordinary

Mark Type:

一系列商標: YES

Series Mark:

[571] 商標描述: N/A

Mark Description:

[730] 註冊申請人的姓名 / 名稱、地址 : China Resources Property Management Limited (華潤物業管理有限公司)
Applicant(s)' Name,Address: Flat/Room 1206-10, 12/F & 37/F, China Resources Building,
26 Harbour Road, Wanchai,
HONG KONG

[740/ 註冊申請人的送達地址 : ACCOLADE IP LIMITED
750] Applicant's Address for 10/F, Fu Fai Comm. Ctr.,
Service: 27 Hillier Street, Sheung Wan,
HONG KONG

[511] 類別編號 : 43
Class(es) No(s) .:

[511] 貨品 / 服務說明 : Class 43:
Specification: Temporary accommodation; hotel services, motel services, motor inn services, resort services; providing meeting and event facilities; restaurant, bar, lounge, cocktail lounge, cafe and cocktail services; services for providing food and drink; providing facilities for meetings and functions; providing facilities for conferences and exhibitions; the operation of hotels and resorts, restaurants and bars.

[526] 卸棄 : N/A
Disclaimer:

[529] 限制 : N/A
Limitation:

[527] 條件 : N/A
Condition:

其他 : N/A
Others

[220] 提交日期 : 09-12-2021
Date of Filing:

[320] 聲稱具有優先權的日期 : N/A
Date of Priority Claimed:

[310] 優先權申請編號 : N/A
Priority Application Number:

[340] 聲稱具有優先權 (部分) : N/A
Priority Claim Details:

[330] 優先權申請的 N/A
國家、地區、地方 :
Country, territory, area of
Priority Applications:

[210] 商標申請編號 : 305835862
Application No.:

- [540] 商標 :
Mark:
- 
- [550] 商標種類 : 一般商標
Mark Type:
- 一系列商標 : 否
Series Mark:
- [571] 商標描述 : 不適用
Mark Description:
- [730] 註冊申請人的姓名 / 名稱、地址 : 神話屋有限公司
Applicant(s) ' (MYTH HOUSE LIMITED)
Name, Address: 香港
新界元朗流浮山
深灣路 23B 號
- [740/ 註冊申請人的送達地址 : 澤昇國際發展有限公司
750] Applicant's Address for 香港
Service: 九龍尖沙咀東部麼地道 63 號
好時中心 3 樓 310 室
- [511] 類別編號 : 43
Class(es) No(s) .:
- [511] 貨品 / 服務說明 : 類別 43:
Specification: 提供食物和飲料服務; 臨時住宿; 小食店; 日間托兒所 (看孩子); 出租椅子、桌子、桌布和玻璃器皿; 餐廳; 自助餐廳; 住所代理 (旅館、供膳寄宿處); 快餐店; 咖啡館; 非劇院、非電視演播室用照明設備出租; 活動房屋出租; 食物雕刻; 旅遊房屋出租; 旅館; 酒吧服務; 酒店; 假日野營住宿服務; 動物寄養; 寄宿處; 寄宿處預訂; 帳篷出租; 烹飪設備出租; 備辦宴席; 提供野營場地設施; 飲水機出租; 會議室出租; 預訂酒店及旅館; 預訂臨時住所; 養老院; 臨時住宿處出租。
- [526] 卸棄 : 申請人並不具有英文字 "Myth" 及 "House" 的專有使用權。
Disclaimer:
- [529] 限制 : 不適用
Limitation:
- [527] 條件 : 不適用
Condition:
- 其他 : 不適用
Others
- [220] 提交日期 : 20-12-2021
Date of Filing:
- [320] 聲稱具有優先權的日期 : 不適用
Date of Priority Claimed:
- [310] 優先權申請編號 : 不適用
Priority Application Number:
- [340] 聲稱具有優先權 (部分) : 不適用
Priority Claim Details:
- [330] 優先權申請的 不適用

國家、地區、地方：

Country, territory, area of

Priority Applications:

[210] 商標申請編號： 305836195

Application No.:

[540] 商標：

Mark:



[550] 商標種類： 一般商標

Mark Type:

一系列商標：

否

Series Mark:

[571] 商標描述： 不適用

Mark Description:

[730] 註冊申請人的姓名 / 名稱、地址：

齊月瑜

Applicant(s)'

香港

Name, Address:

新界沙田區馬鞍山鞍誠街 22 號

新港城 2 期 D 座 14 樓 6 室

[740/ 註冊申請人的送達地址：

齊月瑜

750] Applicant's Address for

香港

Service:

新界沙田區馬鞍山鞍誠街 22 號

新港城 2 期 D 座 14 樓 6 室

[511] 類別編號： 35, 43

Class(es) No(s) .:

[511] 貨品 / 服務說明： 類別 43:

Specification:

餐廳；小食店；快餐店；提供食物和飲料服務；出租椅子、桌子、桌布和玻璃器皿；自助餐廳；咖啡館；酒店；寄宿處；養老院。

[526] 卸棄： 不適用

Disclaimer:

[529] 限制： 不適用

Limitation:

[527] 條件： 不適用

Condition:

其他：

不適用

Others

[220] 提交日期 : 20-12-2021
Date of Filing:
[320] 聲稱具有優先權的日期 : 不適用
Date of Priority Claimed:
[310] 優先權申請編號 : 不適用
Priority Application Number:
[340] 聲稱具有優先權 (部分) : 不適用
Priority Claim Details:
[330] 優先權申請的 不適用
國家、地區、地方 :
Country, territory, area of
Priority Applications:

[210] 商標申請編號 : 305840307
Application No.:
[540] 商標 : A
Mark:



B



[550] 商標種類 : Ordinary
Mark Type:

	一系列商標 :	YES
	Series Mark:	
[571]	商標描述 :	N/A
	Mark Description:	
[730]	註冊申請人的姓名 / 名稱、地址 :	MAXIM'S CATERERS LIMITED
	Applicant(s) ' Name,Address:	18/F, MAXIM'S CENTRE, NO. 17 CHEUNG SHUN STREET, CHEUNG SHA WAN, HONG KONG
[740/750]	註冊申請人的送達地址 :	MAXIM'S CATERERS LIMITED
	Applicant's Address for Service:	18/F, MAXIM'S CENTRE, NO. 17 CHEUNG SHUN STREET, CHEUNG SHA WAN, HONG KONG
[511]	類別編號 :	16,29,30,35,43
	Class(es) No(s) .:	
[511]	貨品 / 服務說明 :	Class 43:
	Specification:	Provision of dine-in and take-away catering services; provision of restaurant, self-service restaurant, buffet restaurant, fast food restaurant, coffee shop services, canteen, catering, tea house, bakery and banqueting services; all included in Class 43.
[526]	卸棄 :	N/A
	Disclaimer:	
[529]	限制 :	N/A
	Limitation:	
[527]	條件 :	N/A
	Condition:	
	其他 :	N/A
	Others	
[220]	提交日期 :	23-12-2021
	Date of Filing:	
[320]	聲稱具有優先權的日期 :	N/A
	Date of Priority Claimed:	
[310]	優先權申請編號 :	N/A
	Priority Application Number:	
[340]	聲稱具有優先權 (部分) :	N/A
	Priority Claim Details:	
[330]	優先權申請的 國家、地區、地方 :	N/A
	Country, territory, area of Priority Applications:	

[210]	商標申請編號 :	305840316
	Application No.:	

[540] 商標 :
Mark:

A



B



[550] 商標種類 : Ordinary
 Mark Type:
 一系列商標 : YES
 Series Mark:

[571] 商標描述 : N/A
 Mark Description:

[730] 註冊申請人的姓名 / 名稱、地址 : MAXIM'S CATERERS LIMITED
 Applicant(s)' 18/F, MAXIM'S CENTRE,
 Name,Address: NO. 17 CHEUNG SHUN STREET, CHEUNG SHA WAN,
 HONG KONG

[740/ 註冊申請人的送達地址 : MAXIM'S CATERERS LIMITED
 750] Applicant's Address for 18/F, MAXIM'S CENTRE,
 Service: NO. 17 CHEUNG SHUN STREET, CHEUNG SHA WAN,
 HONG KONG

[511] 類別編號 : 16,29,30,35,43
 Class(es) No(s) .:

[511] 貨品 / 服務說明 : Class 43:
 Specification: Provision of dine-in and take-away catering
 services; provision of restaurant, self-
 service restaurant, buffet restaurant, fast
 food restaurant, coffee shop services,
 canteen, catering, tea house, bakery and
 banqueting services; all included in Class 43.

[526]	卸棄: Disclaimer:	N/A
[529]	限制: Limitation:	N/A
[527]	條件: Condition: 其他: Others	N/A
[220]	提交日期: Date of Filing:	23-12-2021
[320]	聲稱具有優先權的日期: Date of Priority Claimed:	N/A
[310]	優先權申請編號: Priority Application Number:	N/A
[340]	聲稱具有優先權 (部分): Priority Claim Details:	N/A
[330]	優先權申請的 國家、地區、地方: Country, territory, area of Priority Applications:	N/A
[210]	商標申請編號: Application No.:	305842693
[540]	商標: Mark:	SECONDLIFT
[550]	商標種類: Mark Type: 一系列商標: Series Mark:	Ordinary NO
[571]	商標描述: Mark Description:	N/A
[730]	註冊申請人的姓名/名稱、地址: Applicant(s)' Name, Address:	Stax. Pty Ltd Unit 4, 1801 Botany Road Banksmeadow, NSW, 2019 AUSTRALIA
[740/750]	註冊申請人的送達地址: Applicant's Address for Service:	ABLE CONSULTANCY SERVICES LIMITED Rm 204, 2/F., Lansing House 41-47 Queen's Road Central, Central HONG KONG
[511]	類別編號: Class(es) No(s) .:	9, 25, 43
[511]	貨品/服務說明: Specification:	Class 43: Providing food and drink; Take out food and beverage services; Cafe services

[526] 卸棄:		N/A		
Disclaimer:				
[529] 限制:		N/A		
Limitation:				
[527] 條件:		N/A		
Condition:				
其他:		N/A		
Others				
[220] 提交日期:		24-12-2021		
Date of Filing:				
[320] 聲稱具有優先權的日期:	[310] 優先權申請編號:	[340] 聲稱具有優先權 (部分):	[330] 優先權申請的	
Date of Priority Claimed:	Priority Application No.:	Priority Claim Details:	國家、地區、地方:	
			Country, territory, area of Priority Applications:	
08-12-2021	2234147	for classes 9 and 25	AUSTRALIA	
21-12-2021	2236349	for Class 43	AUSTRALIA	

[210] 商標申請編號: 305842981
Application No.:

[540] 商標: A
Mark:



蝦滷·粉皮

B



蝦 滷 · 粉 皮

- [550] 商標種類：一般商標
Mark Type:
- 一系列商標：是
Series Mark:
- [571] 商標描述：在本系列商標中的商標"A"，申請人聲稱藍色為商標的一個要素。
Mark Description:
- [730] 註冊申請人的姓名 / 名稱、地址：盈寶食品(香港)有限公司
Applicant(s) ' 香港
Name, Address: 新界上水龍琛路 39 號
上水廣場 21 樓 2103 室
- [740/ 註冊申請人的送達地址：達祺知識產權有限公司
750] Applicant's Address for 香港
Service: 灣仔
告士打道 88 號 11 樓 1102 室
- [511] 類別編號：30, 43
Class(es) No(s) .:
- [511] 貨品 / 服務說明：類別 43:
Specification: 提供食物和飲料服務；餐廳；熟食店舖；食肆；食堂；小食店；備辦宴席；流動飲食供應；通過互聯網或外聯網在線提供與食品和飲料製備以及餐飲服務有關的信息；準備食物、膳食和飲料以供堂食、外賣和/或送貨上門。
- [526] 卸棄：不適用
Disclaimer:
- [529] 限制：不適用
Limitation:
- [527] 條件：不適用
Condition:
- 其他：不適用
Others
- [220] 提交日期：24-12-2021
Date of Filing:
- [320] 聲稱具有優先權的日期：不適用
Date of Priority Claimed:
- [310] 優先權申請編號：不適用
Priority Application Number:

[340] 聲稱具有優先權 (部分): 不適用
Priority Claim Details:

[330] 優先權申請的 不適用
國家、地區、地方:
Country, territory, area of
Priority Applications:

[210] 商標申請編號: 305843647
Application No.:

[540] 商標:
Mark:



NAGAMOTO

[550] 商標種類: Ordinary
Mark Type:
一系列商標: NO
Series Mark:

[571] 商標描述: N/A
Mark Description:

[730] 註冊申請人的姓名 / 名稱、地址: ALKE MANAGEMENT LIMITED
Applicant(s) ' 2nd Floor, Tai Yip Building
Name, Address: 141 - 149 Thomson Road, Wan Chai
HONG KONG

[740/ 註冊申請人的送達地址: FUND SERVICES LIMITED
750] Applicant's Address for 2nd Floor, Tai Yip Building
Service: 141 - 149 Thomson Road, Wan Chai
HONG KONG

[511] 類別編號: 43
Class(es) No(s) .:

[511] 貨品 / 服務說明: Class 43:
Specification: Restaurant services for the provision of foods
and drinks

[526] 卸棄: N/A
Disclaimer:

[529] 限制: N/A
Limitation:

[527] 條件: N/A
Condition:
其他: N/A
Others

[220] 提交日期: 28-12-2021
Date of Filing:

[320] 聲稱具有優先權的日期: N/A
Date of Priority Claimed:

[310] 優先權申請編號: N/A

Priority Application Number:

[340] 聲稱具有優先權 (部分): N/A

Priority Claim Details:

[330] 優先權申請的 N/A

國家、地區、地方:

Country, territory, area of

Priority Applications:

[210] 商標申請編號: 305843836

Application No.:

[540] 商標:

Mark:



[550] 商標種類: Ordinary

Mark Type:

一系列商標:

NO

Series Mark:

[571] 商標描述: N/A

Mark Description:

[730] 註冊申請人的姓名 / 名稱、地址:

Applicant(s) '

Name,Address:

TURBO JK COMPANY

301ho, 32, Nonhyeon-ro 157-gil

Gangnam-gu, Seoul 06033

REPUBLIC OF KOREA

[740/ 註冊申請人的送達地址:

750] Applicant's Address for Service:

BKIP Limited

Unit 2202, 22/F, Causeway Bay Plaza I

489 Hennessy Road, Causeway Bay

HONG KONG

[511] 類別編號: 43

Class(es) No(s) .:

[511] 貨品 / 服務說明:

Specification:

Class 43:

Café and restaurant services; coffee and juice bar services; providing food and drink for guests; snack-bar services; cafeteria services; providing information in the field of recipes and cooking from a computer database; take-away food services; salad bars [restaurant services]; take-away food and drink services; hotel and restaurant services; bar and cocktail lounge services; providing campground facilities; rental of rooms for social functions; rental of rooms for holding functions, conferences, conventions, exhibitions, seminars and meetings; rental of tableware, silverware, dishes, and table accessories for special events.

[526] 卸棄:

Disclaimer:

N/A

[529] 限制 : N/A
Limitation:

[527] 條件 : N/A
Condition:
其他 : N/A
Others

[220] 提交日期 : 28-12-2021
Date of Filing:

[320] 聲稱具有優先權的日期 : 28-06-2021
Date of Priority Claimed:

[310] 優先權申請編號 : 40-2021-0132789
Priority Application Number:

[340] 聲稱具有優先權 (部分) : N/A
Priority Claim Details:

[330] 優先權申請的
國家、地區、地方 : REPUBLIC OF KOREA
Country, territory, area of
Priority Applications:

[210] 商標申請編號 : 305844006
Application No.:

[540] 商標 : A
Mark:



B



[550] 商標種類 : Ordinary
Mark Type:
一系列商標 : YES
Series Mark:

[571] 商標描述 : The applicant claims the colours brown and green as elements of mark "A" in the series.
Mark Description:

[730] 註冊申請人的姓名 / 名稱、地址 : Wharen Limited
Applicant(s) ' Unit C2, 2/F., Hong Kong Spinners Ind.
Name, Address: Building Phase 5
760-762 Cheung Sha Wan Road, Kowloon
HONG KONG

[740/ 註冊申請人的送達地址 : Candice Cheung
750] Applicant's Address for Unit C2, 2/F., Hong Kong Spinners Ind.
Service: Building Phase 5
760-762 Cheung Sha Wan Road, Kowloon
HONG KONG

- [511] 類別編號 : 29, 30, 32, 35, 43
Class(es) No(s) .:
- [511] 貨品 / 服務說明 : Class 43:
Specification: Services for providing food and drink;
temporary accommodation.
- [526] 卸棄 : N/A
Disclaimer:
- [529] 限制 : N/A
Limitation:
- [527] 條件 : N/A
Condition:
其他 : N/A
Others
- [220] 提交日期 : 28-12-2021
Date of Filing:
- [320] 聲稱具有優先權的日期 : N/A
Date of Priority Claimed:
- [310] 優先權申請編號 : N/A
Priority Application Number:
- [340] 聲稱具有優先權 (部分) : N/A
Priority Claim Details:
- [330] 優先權申請的
國家、地區、地方 : N/A
Country, territory, area of
Priority Applications:
-
-

- [210] 商標申請編號 : 305846013
Application No.:
- [540] 商標 : A
Mark:



B

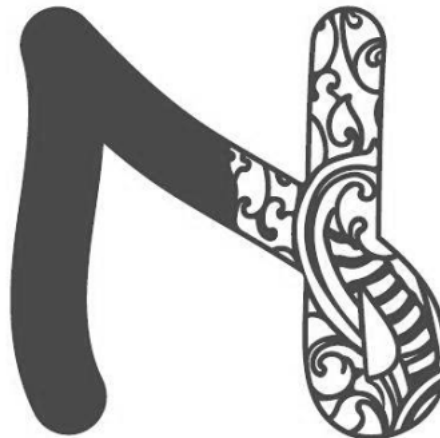

- [550] 商標種類 : Ordinary
 Mark Type:
 一系列商標 : YES
 Series Mark:
- [571] 商標描述 : The applicant claims the colour blue as an
 Mark Description: element of mark "A" in the series.
- [730] 註冊申請人的姓名 / 名稱、地址 : NUK CAFE LIMITED
 Applicant(s) ' 9/F, Sing Shun Centre,
 Name,Address: 495 Castle Peak Road Kowloon
 HONG KONG
- [740/ 註冊申請人的送達地址 : ZAN IP INTERNATIONAL LIMITED
 750] Applicant's Address for FLAT/RM 230, 2/F, BLDG 12W PHASE 3
 Service: 12 SCIENCE PARK WEST AVENUE, HK SCIENCEPARK
 SHATIN, NT
 HONG KONG
- [511] 類別編號 : 21,30,43
 Class(es) No(s) .:
- [511] 貨品 / 服務說明 : Class 43:
 Specification: Coffee shops; Coffee shop services providing
 coffee drinks, food and coffee products;
 Cafeteria, cafe, snack bar, sandwich bar,
 canteen, coffee bar, coffee shop and tea room
 services; Cafe, cafeteria, coffee shop and
 restaurant services providing coffee made by
 machines, automatic apparatus and non-
 automatic apparatus; Providing food and drink
 in restaurants, cafes, cafeterias, snack bars
 and coffee houses; Dining and restaurant
 services; Juice bars; Bar, cafe, cafeteria and
 canteen services; Boarding house and hotel
 services; Rental of meeting rooms, temporary
 accommodation, transportable buildings and
 tents; Provision of cafe, cafeteria, canteen,
 catering and cocktail lounge services
- [526] 卸棄 : N/A
 Disclaimer:
- [529] 限制 : N/A
 Limitation:

[527] 條件 : N/A
Condition:
其他 : N/A
Others

[220] 提交日期 : 29-12-2021
Date of Filing:

[320] 聲稱具有優先權的日期 : N/A
Date of Priority Claimed:

[310] 優先權申請編號 : N/A
Priority Application Number:

[340] 聲稱具有優先權 (部分) : N/A
Priority Claim Details:

[330] 優先權申請的
國家、地區、地方 : N/A
Country, territory, area of
Priority Applications:

[210] 商標申請編號 : 305846950
Application No.:

[540] 商標 :
Mark:

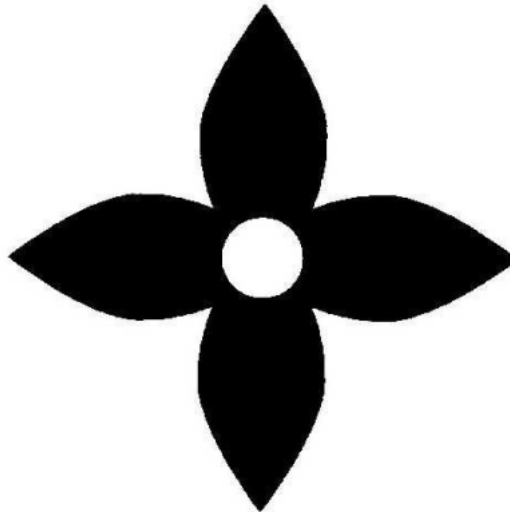

[550] 商標種類 : Ordinary
Mark Type:
一系列商標 : NO
Series Mark:

[571] 商標描述 : N/A
Mark Description:

[730] 註冊申請人的姓名 / 名稱、地址 : LOUIS VUITTON MALLETIER
Applicant(s) ' 2, RUE DU PONT-NEUF,
Name,Address: 75001 PARIS,
FRANCE

[740/ 註冊申請人的送達地址 : BAKER & MCKENZIE
750] Applicant's Address for 14TH FLOOR, ONE TAIKOO PLACE,
Service:

979 KING'S ROAD, QUARRY BAY,
HONG KONG

- [511] 類別編號 : 3,24,34,43
Class(es) No(s) .:
- [511] 貨品 / 服務說明 : Class 43:
Specification: Decorating of food; information and advice in relation to the preparation of meals; rental of chairs, tables, table linen, glassware; rental of temporary accommodation; temporary accommodation reservations; accommodation bureau services [hotels, boarding houses]; bar services; café services; cafeteria services; canteen services; personal chef services; restaurant services; food and drink catering; hotel services; rental of meeting rooms.
- [526] 卸棄 : N/A
Disclaimer:
- [529] 限制 : N/A
Limitation:
- [527] 條件 : N/A
Condition:
其他 : N/A
Others
- [220] 提交日期 : 30-12-2021
Date of Filing:
- [320] 聲稱具有優先權的日期 : N/A
Date of Priority Claimed:
- [310] 優先權申請編號 : N/A
Priority Application Number:
- [340] 聲稱具有優先權 (部分) : N/A
Priority Claim Details:
- [330] 優先權申請的
國家、地區、地方 : N/A
Country, territory, area of
Priority Applications:
-
-

- [210] 商標申請編號 : 305846969
Application No.:

[540] 商標 :
Mark:

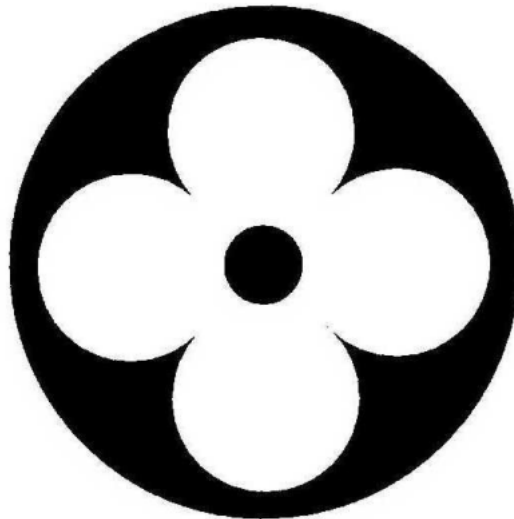

[550] 商標種類 : Ordinary
Mark Type:
一系列商標 : NO
Series Mark:

[571] 商標描述 : N/A
Mark Description:

[730] 註冊申請人的姓名 / 名稱、地址 : LOUIS VUITTON MALLETIER
Applicant(s) ' 2, RUE DU PONT-NEUF,
Name,Address: 75001 PARIS,
FRANCE

[740/ 註冊申請人的送達地址 : BAKER & MCKENZIE
750] Applicant's Address for 14TH FLOOR, ONE TAIKOO PLACE,
Service: 979 KING'S ROAD, QUARRY BAY,
HONG KONG

[511] 類別編號 : 24,34,43
Class(es) No(s) .:

[511] 貨品 / 服務說明 : Class 43:
Specification: Decorating of food; information and advice in
relation to the preparation of meals; rental
of chairs, tables, table linen, glassware;
rental of temporary accommodation; temporary
accommodation reservations; accommodation
bureau services [hotels, boarding houses]; bar
services; café services; cafeteria services;
canteen services; personal chef services;
restaurant services; food and drink catering;
hotel services; rental of meeting rooms.

[526] 卸棄 : N/A
Disclaimer:

[529] 限制 : N/A
Limitation:

[527] 條件 : N/A
Condition:
其他 : N/A
Others

[220] 提交日期 : 30-12-2021
Date of Filing:

[320] 聲稱具有優先權的日期 : N/A
Date of Priority Claimed:
[310] 優先權申請編號 : N/A
Priority Application Number:
[340] 聲稱具有優先權 (部分) : N/A
Priority Claim Details:
[330] 優先權申請的 N/A
國家、地區、地方 :
Country, territory, area of
Priority Applications:

[210] 商標申請編號 : 305846978
Application No.:

[540] 商標 :
Mark:

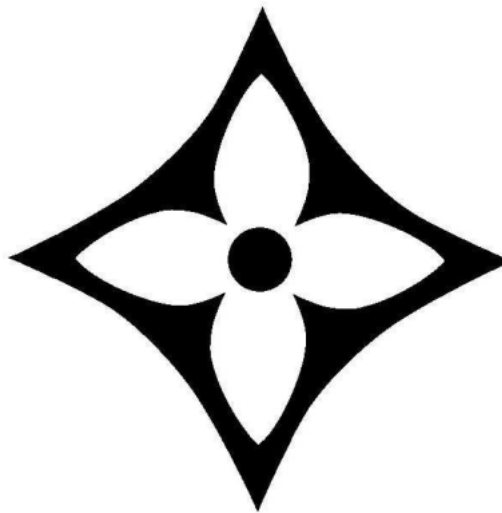

[550] 商標種類 : Ordinary
Mark Type:
一系列商標 : NO
Series Mark:

[571] 商標描述 : N/A
Mark Description:

[730] 註冊申請人的姓名 / 名稱、地址 : LOUIS VUITTON MALLETIER
Applicant(s) ' 2, RUE DU PONT-NEUF,
Name,Address: 75001 PARIS,
FRANCE

[740/ 註冊申請人的送達地址 : BAKER & MCKENZIE
750] Applicant's Address for 14TH FLOOR, ONE TAIKOO PLACE,
Service: 979 KING'S ROAD, QUARRY BAY,
HONG KONG

[511] 類別編號 : 16,24,34,43
Class(es) No(s) .:

[511] 貨品 / 服務說明 : Class 43:
Specification: Decorating of food; information and advice in
relation to the preparation of meals; rental
of chairs, tables, table linen, glassware;

rental of temporary accommodation; temporary accommodation reservations; accommodation bureau services [hotels, boarding houses]; bar services; café services; cafeteria services; canteen services; personal chef services; restaurant services; food and drink catering; hotel services; rental of meeting rooms.

- [526] 卸棄 : N/A
Disclaimer:
- [529] 限制 : N/A
Limitation:
- [527] 條件 : N/A
Condition:
其他 : N/A
Others
- [220] 提交日期 : 30-12-2021
Date of Filing:
- [320] 聲稱具有優先權的日期 : N/A
Date of Priority Claimed:
- [310] 優先權申請編號 : N/A
Priority Application Number:
- [340] 聲稱具有優先權 (部分) : N/A
Priority Claim Details:
- [330] 優先權申請的
國家、地區、地方 : N/A
Country, territory, area of
Priority Applications:

-
- [210] 商標申請編號 : 305846996
Application No.:

- [540] 商標 :
Mark:



- [550] 商標種類 : Ordinary
Mark Type:
一系列商標 : NO
Series Mark:
- [571] 商標描述 : N/A
Mark Description:

- [730] 註冊申請人的姓名 / 名稱、地址 : BL F&B Limited (萬隆食品有限公司)
Applicant(s)' Rm 2708, 27/F, China Resources Building
Name,Address: 26 Harbour Road, Wanchai
HONG KONG
- [740/ 註冊申請人的送達地址 : BKIP Limited
750] Applicant's Address for Unit 2202, 22/F, Causeway Bay Plaza I
Service: 489 Hennessy Road, Causeway Bay
HONG KONG
- [511] 類別編號 : 29,30,35,43
Class(es) No(s) .:
- [511] 貨品 / 服務說明 : Class 43:
Specification: Restaurant services and takeaway fast food
services providing ice creams, desserts, dairy
products and beverages; preparation and
serving of ice creams and other dairy products
for on and off premises consumption; dessert
shops; services for providing food and drink;
temporary accommodation; providing information
relating to restaurant and bar services on-
line from a computer database or via the
Internet or extranets; providing food and
beverages at restaurants with Internet
equipment; provision of catering services via
an on-line computer network; provision of
take-away or delivery food ordered by
telephone or facsimile or through an online
computer network.
- [526] 卸棄 : N/A
Disclaimer:
- [529] 限制 : N/A
Limitation:
- [527] 條件 : N/A
Condition:
其他 : N/A
Others
- [220] 提交日期 : 30-12-2021
Date of Filing:
- [320] 聲稱具有優先權的日期 : N/A
Date of Priority Claimed:
- [310] 優先權申請編號 : N/A
Priority Application Number:
- [340] 聲稱具有優先權 (部分) : N/A
Priority Claim Details:
- [330] 優先權申請的 N/A
國家、地區、地方 :
Country, territory, area of
Priority Applications:
-
- [210] 商標申請編號 : 305847968
Application No.:

[540] 商標 :	
Mark:	MPASS
[550] 商標種類 :	一般商標
Mark Type:	
一系列商標 :	否
Series Mark:	
[571] 商標描述 :	不適用
Mark Description:	
[730] 註冊申請人的姓名 / 名稱、地址 :	澳門 MPASS 數字化生活服務一人有限公司
Applicant(s) ' Name, Address:	澳門 宋玉生廣場 322-362 號 誠豐商業中心 3 樓 0 座
[740/ 註冊申請人的送達地址 :	麥仕奇知識產權
750] Applicant's Address for Service:	香港 薄扶林 數碼港道 100 號 數碼港一座 9 樓
[511] 類別編號 :	9, 28, 35, 36, 39, 41, 42, 43
Class(es) No(s) .:	
[511] 貨品 / 服務說明 :	類別 43:
Specification:	外賣餐館; 餐館預訂服務; 餐廳服務; 通過互聯網預訂臨時住宿; 酒店房間預訂服務; 臨時住宿的接待服務 (抵達及離開的管理); 提供休息室服務; 旅遊房屋出租; 酒店提供的餐飲供應服務; 面向優先客戶的酒店服務。
[526] 卸棄 :	不適用
Disclaimer:	
[529] 限制 :	不適用
Limitation:	
[527] 條件 :	不適用
Condition:	
其他 :	不適用
Others	
[220] 提交日期 :	31-12-2021
Date of Filing:	
[320] 聲稱具有優先權的日期 :	不適用
Date of Priority Claimed:	
[310] 優先權申請編號 :	不適用
Priority Application Number:	
[340] 聲稱具有優先權 (部分) :	不適用
Priority Claim Details:	
[330] 優先權申請的 國家、地區、地方 :	不適用
Country, territory, area of Priority Applications:	

[210] 商標申請編號 : 305849605
Application No.:

[540] 商標 :
Mark:

A



B



[550] 商標種類 : Ordinary

Mark Type:

一系列商標 :

YES

Series Mark:

[571] 商標描述 : N/A

Mark Description:

[730] 註冊申請人的姓名 / 名稱、地址 :

Applicant(s)'

Name, Address:

Tiny Bar Limited
4404, 44/F, Hopewell Centre
183 Queen's Road Wanchai
HONG KONG

[740/ 註冊申請人的送達地址 :

HALDANES

750] Applicant's Address for
Service:

7/F, Ruttonjee House
11 Duddell Street, Central
HONG KONG

[511] 類別編號 :

Class(es) No(s) .:

25, 30, 35, 43

[511] 貨品 / 服務說明 :

Specification:

Class 43:

Catering services; bar services; food and drinks catering; restaurants; self-service restaurant; snack bars; services for providing food and drink's; cafés; cafeterias; canteens; delicatessens; providing information relating to preparation of foods and beverages and catering services; preparation and provisional

of food, meals and beverages for dining, takeaway and/or home delivery; provision of information, advisory and consultancy services relating to the aforesaid services.

- [526] 卸棄: N/A
Disclaimer:
- [529] 限制: N/A
Limitation:
- [527] 條件: N/A
Condition:
其他: N/A
Others
- [220] 提交日期: 04-01-2022
Date of Filing:
- [320] 聲稱具有優先權的日期: N/A
Date of Priority Claimed:
- [310] 優先權申請編號: N/A
Priority Application Number:
- [340] 聲稱具有優先權 (部分): N/A
Priority Claim Details:
- [330] 優先權申請的
國家、地區、地方: N/A
Country, territory, area of
Priority Applications:

-
- [210] 商標申請編號: 305849975
Application No.:
- [540] 商標:
Mark:

鴨滋味

- [550] 商標種類: 一般商標
Mark Type:
一系列商標: 否
Series Mark:

- [571] 商標描述 : 不適用
Mark Description:
- [730] 註冊申請人的姓名 / 名稱、地址 : 隆陽區鴨滋味飯店
Applicant(s) ' 中國
Name, Address: 雲南省保山市
隆陽區永昌街道辦事處隆陽小區和平路 141 號
- [740/ 註冊申請人的送達地址 : 東靈通國際品牌諮詢集團有限公司
750] Applicant's Address for 香港
Service: 灣仔軒尼詩道 338 號
北海中心 10 樓 E 室
- [511] 類別編號 : 43
Class(es) No(s) .:
- [511] 貨品 / 服務說明 : 類別 43:
Specification: 中式餐館 ; 臨時住宿的接待服務 (抵達及離開的管理) ; 住所代理 (旅館、供膳寄宿處) ; 備辦宴席 ; 冷熱飲料店 (店內飲用) ; 咖啡廳 ; 小吃店 ; 快餐館服務 ; 提供食物服務 (堂食及外賣) ; 自助餐廳
- [526] 卸棄 : 不適用
Disclaimer:
- [529] 限制 : 不適用
Limitation:
- [527] 條件 : 不適用
Condition:
其他 : 不適用
Others
- [220] 提交日期 : 04-01-2022
Date of Filing:
- [320] 聲稱具有優先權的日期 : 不適用
Date of Priority Claimed:
- [310] 優先權申請編號 : 不適用
Priority Application Number:
- [340] 聲稱具有優先權 (部分) : 不適用
Priority Claim Details:
- [330] 優先權申請的 不適用
國家、地區、地方 :
Country, territory, area of
Priority Applications:
-
-

- [210] 商標申請編號 : 305850441
Application No.:

[540] 商標：
Mark:



[550] 商標種類： 一般商標
Mark Type:
一系列商標： 否
Series Mark:

[571] 商標描述： 不適用
Mark Description:

[730] 註冊申請人的姓名 / 名稱、地址： 永祥（國際）貿易有限公司 (WINFRED (INTERNATIONAL)
Applicant(s) ' TRADING LIMITED)
Name,Address: 香港
北角渣華道 18 號
嘉匯商業大廈 5 樓 6 室

[740/ 註冊申請人的送達地址： 偉寶顧問有限公司
750] Applicant's Address for 香港
Service: 北角渣華道 8 號
威邦商業中心 1607 室

[511] 類別編號： 29, 43
Class(es) No(s) .:

[511] 貨品 / 服務說明： 類別 43:
Specification: 提供食物和飲料服務

[526] 卸棄： 不適用
Disclaimer:

[529] 限制： 不適用
Limitation:

[527] 條件： 不適用
Condition:
其他： 不適用
Others

[220] 提交日期： 05-01-2022
Date of Filing:

[320] 聲稱具有優先權的日期： 不適用
Date of Priority Claimed:

[310] 優先權申請編號： 不適用
Priority Application Number:

[340] 聲稱具有優先權 (部分): 不適用

Priority Claim Details:

[330] 優先權申請的 不適用

國家、地區、地方:

Country, territory, area of
Priority Applications:

[210] 商標申請編號: 305850982

Application No.:

[540] 商標:

Mark:

[550] 商標種類: 一般商標

Mark Type:

一系列商標:

否

Series Mark:

[571] 商標描述: 不適用

Mark Description:

[730] 註冊申請人的姓名 / 名稱、地址:

洪師父食品有限公司

Applicant(s)'

台灣

Name, Address:

台北市內湖區

新湖三路 237 號 郵編 114

[740/ 註冊申請人的送達地址:

百睿知識產權有限公司

750] Applicant's Address for

香港

Service:

新界沙田香港科學園

科技大道西 10 號浚湖樓 617 室

[511] 類別編號: 43

Class(es) No(s) .:

[511] 貨品 / 服務說明: 類別 43:

Specification:

小吃店; 小吃攤; 火鍋店; 牛排館; 牛肉麵店; 有關餐食準備之資訊和諮詢; 備辦餐飲; 提供外送服務之餐廳; 提供外帶服務之餐廳; 提供餐食及飲料之服務; 提供餐飲服務; 飲食店; 複合式餐廳; 餐館; 餐廳; 伙食包辦; 外燴; 快餐車; 拉麵店; 機場休息室服務; 流動飲食攤; 預訂餐廳服務; 自助餐廳; 烏龍麵餐廳服務; 玻璃器皿出租; 家具租賃; 桌子、椅子、桌布及玻璃器皿出租; 桌子、椅子、桌布出租; 烹飪設備出租; 廚房用具出租

[526] 卸棄: 不適用

Disclaimer:

[529] 限制: 不適用

Limitation:

[527] 條件: 不適用

Condition:

其他 : 不適用
Others
[220] 提交日期 : 06-01-2022
Date of Filing:
[320] 聲稱具有優先權的日期 : 不適用
Date of Priority Claimed:
[310] 優先權申請編號 : 不適用
Priority Application Number:
[340] 聲稱具有優先權 (部分) : 不適用
Priority Claim Details:
[330] 優先權申請的
國家、地區、地方 : 不適用
Country, territory, area of
Priority Applications:

[210] 商標申請編號 : 305851071
Application No.:

[540] 商標 :
Mark:

A



B



C



[550] 商標種類 : Ordinary
Mark Type:
一系列商標 : YES
Series Mark:

[571] 商標描述 : The applicant claims the colours red and dark grey as elements of mark "A" in the series; and the colours red and light grey as elements of mark "B" in the series.
Mark Description:

[730] 註冊申請人的姓名 / 名稱、地址 : TRESPLAIN INVESTMENTS LIMITED
Applicant(s) ' 11/F., GOLDEN RESOURCES CENTRE
Name, Address: 2-12 CHEUNG TAT ROAD, TSING YI ISLAND, N.T.
HONG KONG

[740/ 註冊申請人的送達地址 : LAM SAI HO ANTHONY
750] Applicant's Address for 11/F., GOLDEN RESOURCES CENTRE
Service: 2-12 CHEUNG TAT ROAD, TSING YI ISLAND, N.T.
HONG KONG

[511] 類別編號 : 30, 43
Class(es) No(s) .:

[511] 貨品 / 服務說明 : Specification:	Class 43: Services for providing food and drink; temporary accommodation
[526] 卸棄 : Disclaimer:	N/A
[529] 限制 : Limitation:	N/A
[527] 條件 : Condition: 其他 : Others	N/A
[220] 提交日期 : Date of Filing:	06-01-2022
[320] 聲稱具有優先權的日期 : Date of Priority Claimed:	N/A
[310] 優先權申請編號 : Priority Application Number:	N/A
[340] 聲稱具有優先權 (部分) : Priority Claim Details:	N/A
[330] 優先權申請的 國家、地區、地方 : Country, territory, area of Priority Applications:	N/A

[210] 商標申請編號 : 305851242
Application No.:

[540] 商標 :
Mark:

A



B



[550] 商標種類 : Ordinary
Mark Type:
一系列商標 : YES
Series Mark:

[571] 商標描述 : N/A
Mark Description:

- [730] 註冊申請人的姓名 / 名稱、地址 : EAT TOGETHER FOOD & BEVERAGE GROUP COMPANY
Applicant(s)' LIMITED
Name,Address: FLAT/RM A & B, BLK2, G/F,
49-53 TA CHUEN PING STREET, KWAI CHUNG, NT,
HONG KONG
- [740/ 註冊申請人的送達地址 : PROREG INTELLECTUAL PROPERTY CONSULTING
750] Applicant's Address for LIMITED
Service: 29/F, Tower 5 The Gateway, Harbour City,
15 Canton Road, Tsim Sha Tsui, Kowloon,
HONG KONG
- [511] 類別編號 : 43
Class(es) No(s) .:
- [511] 貨品 / 服務說明 : Class 43:
Specification: Restaurant services; Chinese Restaurants
services; Cantonese cuisine restaurants; cha
chaan teng; Hong Kong-style diners; tea
restaurants; catering services; canteen
services; cafe services; preparation and
provision of meals, food and beverages for
dine-in or takeaway; preparation and provision
of take-out and takeaway food and drink;
provision of food and drink; provision of
take-away or delivery food and drink ordered
by telephone, online websites, the Internet or
mobile application; provision of information
in relation to all the above services and
provision of information in relation to all
the above services via online website, social
media website; providing information relating
to restaurant and catering service online from
a computer database or via the internet;
Chinese noodle shop services; congee and
noodle shop services; noodle shop services;
restaurant services for the provision of
noodles, rice noodles, congee, dim sum,
Chinese dishes, Chinese traditional pastries,
drinks and desserts; all the above services
are included in Class 43.
- [526] 卸棄 : N/A
Disclaimer:
- [529] 限制 : N/A
Limitation:
- [527] 條件 : N/A
Condition:
其他 : N/A
Others
- [220] 提交日期 : 06-01-2022
Date of Filing:
- [320] 聲稱具有優先權的日期 : N/A
Date of Priority Claimed:
- [310] 優先權申請編號 : N/A
Priority Application Number:
- [340] 聲稱具有優先權 (部分) : N/A
Priority Claim Details:

[330] 優先權申請的 N/A
國家、地區、地方：
Country, territory, area of
Priority Applications:

[210] 商標申請編號： 305852430
Application No.:

[540] 商標： A
Mark:

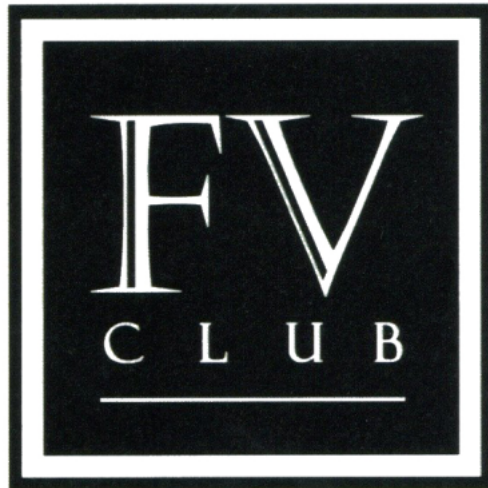

B



[550] 商標種類： Ordinary
Mark Type:
一系列商標： YES

Series Mark:

[571] 商標描述： The applicant claims the colour gold as an
Mark Description: element of mark "B" in the series.

[730] 註冊申請人的姓名 / 名稱、地址： F. V. CLUB HOUSE LIMITED (早禾居會所有限公司)
Applicant(s) ' 15th Floor, TS Tower
Name,Address: 43 Heung Yip Road, Wong Chuk Hang,
HONG KONG

[740/ 註冊申請人的送達地址 : F. V. CLUB HOUSE LIMITED (早禾居會所有限公司)
750] Applicant's Address for 15th Floor, TS Tower,
Service: 43 Heung Yip Road Wong Chuk Hang
HONG KONG

[511] 類別編號 : 28,35,36,37,41,43
Class(es) No(s) .:

[511] 貨品 / 服務說明 : Class 43:
Specification: Services for providing food and drink

[526] 卸棄 : N/A
Disclaimer:

[529] 限制 : N/A
Limitation:

[527] 條件 : N/A
Condition:
其他 : N/A
Others

[220] 提交日期 : 07-01-2022
Date of Filing:

[320] 聲稱具有優先權的日期 : N/A
Date of Priority Claimed:

[310] 優先權申請編號 : N/A
Priority Application Number:

[340] 聲稱具有優先權 (部分) : N/A
Priority Claim Details:

[330] 優先權申請的 N/A
國家、地區、地方 :
Country, territory, area of
Priority Applications:

[210] 商標申請編號 : 305854294
Application No.:

[540] 商標 :
Mark:



[550] 商標種類 : Ordinary
Mark Type:
一系列商標 : NO
Series Mark:

- [571] 商標描述 : The applicant claims the colours yellow and black as elements of the trade mark
Mark Description:
- [730] 註冊申請人的姓名 / 名稱、地址 : Nuevo Tapas Global Limited
Applicant(s) ' Flat/Rm N, Block B, Ground Floor
Name, Address: Winner Building
8 -16 Wing Wah Lane, Central
HONG KONG
- [740/ 註冊申請人的送達地址 : Nuevo Tapas Global Limited
750] Applicant's Address for Flat/Rm N, Block B, Ground Floor
Service: Winner Building
8 - 16 Wing Wah Lane, Central
HONG KONG
- [511] 類別編號 : 43
Class(es) No(s) .:
- [511] 貨品 / 服務說明 : Class 43:
Specification: Bars; bistros; cafés; restaurants; cafeterias;
coffee-house and snack-bar services; cocktail
lounge services; pubs; provision of eating and
drinking establishment services;
delicatessens; salad bars; serving of
alcoholic beverages; catering services for the
provision of prepared, ready-to-consume and
fresh food items and beverages for
consumption; business catering services; food
preparation services; preparation and
provision of food and drink for immediate
consumption; preparation and provision of food
and drink for consumption off the premises;
take-away food services; rental of rooms for
holding functions; consultancy services in the
field of food and drink catering; consultancy
services in the field of culinary arts.
- [526] 卸棄 : N/A
Disclaimer:
- [529] 限制 : N/A
Limitation:
- [527] 條件 : N/A
Condition:
其他 : N/A
Others
- [220] 提交日期 : 10-01-2022
Date of Filing:
- [320] 聲稱具有優先權的日期 : N/A
Date of Priority Claimed:
- [310] 優先權申請編號 : N/A
Priority Application Number:
- [340] 聲稱具有優先權 (部分) : N/A
Priority Claim Details:
- [330] 優先權申請的 N/A
國家、地區、地方 :
Country, territory, area of
Priority Applications:

[210] 商標申請編號: 305854762

Application No.:

[540] 商標:

Mark:



[550] 商標種類: 一般商標

Mark Type:

一系列商標:

否

Series Mark:

[571] 商標描述: 不適用

Mark Description:

[730] 註冊申請人的姓名 / 名稱、地址:

上海益申園苑餐飲管理有限公司

Applicant(s) '

中國

Name, Address:

上海市徐匯區

漕寶路 33 號 2F 層 L2-02/03 號

[740/ 註冊申請人的送達地址:

環曉國際有限公司

750] Applicant's Address for

香港

Service:

成業街 30 號

華富工貿中心 13 樓 1305 室

[511] 類別編號:

35, 43

Class(es) No(s) .:

[511] 貨品 / 服務說明:

類別 43:

Specification:

飯店; 咖啡館; 食物雕刻; 餐廳; 自助餐廳; 備辦宴席; 私人廚師服務; 茶館; 流動飲食供應; 快餐館

[526] 卸棄:

不適用

Disclaimer:

[529] 限制:

不適用

Limitation:

[527] 條件:

不適用

Condition:

其他:

不適用

Others

[220] 提交日期:

11-01-2022

Date of Filing:

- [320] 聲稱具有優先權的日期 : 不適用
Date of Priority Claimed:
- [310] 優先權申請編號 : 不適用
Priority Application Number:
- [340] 聲稱具有優先權 (部分) : 不適用
Priority Claim Details:
- [330] 優先權申請的
國家、地區、地方 : 不適用
Country, territory, area of
Priority Applications:

- [210] 商標申請編號 : 305857048
Application No.:

- [540] 商標 :
Mark:



CORKS
— WINE & BAR —

- [550] 商標種類 : Ordinary
Mark Type:
- 一系列商標 : NO
Series Mark:
- [571] 商標描述 : N/A
Mark Description:
- [730] 註冊申請人的姓名 / 名稱、地址 : MIAM CONCEPTS LIMITED
Applicant(s) ' SHOP A-B, G/F 205C HOLLYWOOD ROAD,
Name, Address: SHEUNG WAN,
HONG KONG
- [740/ 註冊申請人的送達地址 : CASTELLINO CHRISTOPHE
750] Applicant's Address for FLAT A, 21F, ROWEN COURT,
Service: 25 BABINGTON PATH, MID-LEVELS,
HONG KONG
- [511] 類別編號 : 43
Class(es) No(s) .:
- [511] 貨品 / 服務說明 : Class 43:
Specification: services providing drink tastings; self-
service restaurants; services for providing
food and drink; snack-bars; restaurants;
cafés; cafeterias; bar services; drink shops.

[526] 卸棄:	N/A
Disclaimer:	
[529] 限制:	N/A
Limitation:	
[527] 條件:	N/A
Condition:	
其他:	N/A
Others	
[220] 提交日期:	13-01-2022
Date of Filing:	
[320] 聲稱具有優先權的日期:	N/A
Date of Priority Claimed:	
[310] 優先權申請編號:	N/A
Priority Application Number:	
[340] 聲稱具有優先權 (部分):	N/A
Priority Claim Details:	
[330] 優先權申請的	N/A
國家、地區、地方:	
Country, territory, area of	
Priority Applications:	
<hr/>	
[210] 商標申請編號:	305857570
Application No.:	
[540] 商標:	A
Mark:	YAKIFRENCHY
	B
	Yakifrenchy
	C
	yakifrenchy
[550] 商標種類:	Ordinary
Mark Type:	
一系列商標:	YES
Series Mark:	
[571] 商標描述:	N/A
Mark Description:	
[730] 註冊申請人的姓名 / 名稱、地址:	ELZER, Olivier Jean Claude Erich (岳力華)
Applicant(s) 'Name,Address:	Floor 23, Bowen's Lookout, 13 Bowen Road, Mid-Levels, HONG KONG
[740/ 註冊申請人的送達地址:	ACCOLADE IP LIMITED
750] Applicant's Address for Service:	10/F, Fu Fai Comm. Ctr., 27 Hillier Street, Sheung Wan, HONG KONG

- [511] 類別編號 : 43
Class(es) No(s) :
[511] 貨品 / 服務說明 : Class 43:
Specification: Services for providing food and drink;
restaurant services; banquet services;
catering services; cocktail lounge services;
coffee shop, snack bar, café, fast food
restaurant, self-service restaurant and
cafeteria services, bar and canteen services;
arranging and conducting of banquets;
preparing and serving food and drink for
consumption.
- [526] 卸棄 : N/A
Disclaimer:
- [529] 限制 : N/A
Limitation:
- [527] 條件 : N/A
Condition:
其他 : N/A
Others
- [220] 提交日期 : 13-01-2022
Date of Filing:
- [320] 聲稱具有優先權的日期 : N/A
Date of Priority Claimed:
- [310] 優先權申請編號 : N/A
Priority Application Number:
- [340] 聲稱具有優先權 (部分) : N/A
Priority Claim Details:
- [330] 優先權申請的
國家、地區、地方 : N/A
Country, territory, area of
Priority Applications:
-
-

- [210] 商標申請編號 : 305857778
Application No.:
- [540] 商標 : A
Mark:



B



- [550] 商標種類 : Ordinary
 Mark Type:
 一系列商標 : YES
 Series Mark:
- [571] 商標描述 : N/A
 Mark Description:
- [730] 註冊申請人的姓名 / 名稱、地址 : Lai Sun Dining Limited
 Applicant(s) ' 11/F, Lai Sun Commercial Centre,
 Name,Address: 680 Cheung Sha Wan Road, Kowloon,
 HONG KONG
- [740/ 註冊申請人的送達地址 : MAYER BROWN
 750] Applicant's Address for 16th-19th Floors, Prince's Building,
 Service: 10 Chater Road, Central,
 HONG KONG
- [511] 類別編號 : 43
 Class(es) No(s) .:
- [511] 貨品 / 服務說明 : Class 43:
 Specification: Services for providing food and drink;
 temporary accommodation; restaurants, bars,
 bistros, bakeries, cafés, cafeterias,
 canteens, coffee shops, snack bars, tea
 houses, lounges, self-service and buffet
 restaurants; restaurant, bar, bistro, bakery,
 café, cafeteria, canteen, coffee-shop, snack-
 bar, tea-house, lounge, self-service and
 buffet restaurant services; Vietnamese
 restaurant services; catering services; cake
 shop services (other than retailing); cocktail
 lounge services; ice cream shop services;
 confectioner's shop services; delicatessen
 shop services; catering services provided
 online from a computer database or from the
 Internet; information relating to food, drink
 and catering services provided online from a
 computer database or from the Internet;
 providing of catering information by text and
 images in the field of food, drink and
 catering via a website; providing information
 relating to restaurant and bar services on-
 line from a computer database or via the
 Internet or extranets; provision of
 information relating to restaurant and bar

services; restaurant reservation services; provision of dine-in and take-away catering services; providing facilities for banquets, exhibitions, conferences and trade fairs; provision of restaurant, self-service restaurant, buffet restaurant, fast food restaurant, canteen, coffee shop, cafeteria, catering, cocktail lounge, bistro, healthy food and snack bar, tea house, bakery and banqueting services; banquet services; hotel, motel and guest house accommodation services; temporary accommodation services; temporary accommodation reservation services; consultancy, advisory and information services relating to the aforesaid services.

- [526] 卸棄 : N/A
Disclaimer:
- [529] 限制 : N/A
Limitation:
- [527] 條件 : N/A
Condition:
其他 : N/A
Others
- [220] 提交日期 : 13-01-2022
Date of Filing:
- [320] 聲稱具有優先權的日期 : N/A
Date of Priority Claimed:
- [310] 優先權申請編號 : N/A
Priority Application Number:
- [340] 聲稱具有優先權 (部分) : N/A
Priority Claim Details:
- [330] 優先權申請的
國家、地區、地方 : N/A
Country, territory, area of
Priority Applications:
-
-

- [210] 商標申請編號 : 305858245
Application No.:

[540] 商標 :
Mark:

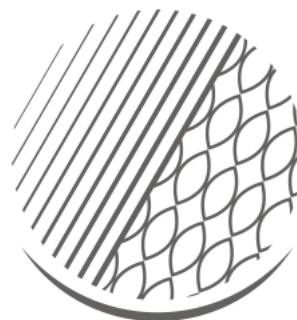

OOMAKI

[550] 商標種類 : Ordinary
Mark Type:
一系列商標 : NO
Series Mark:

[571] 商標描述 : N/A
Mark Description:

[730] 註冊申請人的姓名 / 名稱、地址 : MAX CREATION ASIA LIMITED
Applicant(s) ' RM1207-1209, 12/F, WING ON PLAZA,
Name,Address: 62 MODY ROAD, TSIM SHA TSUI, KL,
HONG KONG

[740/ 註冊申請人的送達地址 : CONPAK INTELLECTUAL PROPERTY LIMITED
750] Applicant's Address for Rooms 05-15, 13A/F, South Tower, World Finance
Service: Centre,
Harbour City, 17 Canton Road, Tsim Sha Tsui,
Kowloon
HONG KONG

[511] 類別編號 : 43
Class(es) No(s) .:

[511] 貨品 / 服務說明 : Class 43:
Specification: Bar services; café services; cafeteria
services; cake decorating; canteen services;
decorating of food; food and drink catering;
information and advice in relation to the
preparation of meals; personal chef services;
restaurant services; snack-bar services; self-
service restaurant services; udon and soba
restaurant services; washoku restaurant
services; all included in Class 43.

[526] 卸棄 : N/A
Disclaimer:

[529] 限制 : N/A
Limitation:

[527] 條件 : N/A
Condition:
其他 : N/A
Others

[220] 提交日期 : 14-01-2022
Date of Filing:

[320] 聲稱具有優先權的日期 : N/A
Date of Priority Claimed:

[310] 優先權申請編號 : N/A
Priority Application Number:

[340] 聲稱具有優先權 (部分) : N/A
Priority Claim Details:

[330] 優先權申請的
國家、地區、地方 : N/A
Country, territory, area of
Priority Applications:

[210] 商標申請編號 : 305858254
Application No.:

[540] 商標 :
Mark:



[550] 商標種類 : Ordinary
Mark Type:

一系列商標 : NO
Series Mark:

[571] 商標描述 : N/A
Mark Description:

[730] 註冊申請人的姓名 / 名稱、地址 : MAX CREATION ASIA LIMITED
Applicant(s) ' RM1207-1209, 12/F, WING ON PLAZA,
Name,Address: 62 MODY ROAD, TSIM SHA TSUI, KL,
HONG KONG

[740/ 註冊申請人的送達地址 : CONPAK INTELLECTUAL PROPERTY LIMITED
750] Applicant's Address for Rooms 05-15, 13A/F, South Tower, World Finance
Service: Centre,
Harbour City, 17 Canton Road, Tsim Sha Tsui,
Kowloon
HONG KONG

[511] 類別編號 : 43
Class(es) No(s) .:

[511] 貨品 / 服務說明 : Class 43:
Specification: Bar services; café services; cafeteria
services; cake decorating; canteen services;
decorating of food; food and drink catering;
information and advice in relation to the
preparation of meals; personal chef services;
restaurant services; snack-bar services; self-
service restaurant services; udon and soba

restaurant services; washoku restaurant services; all included in Class 43.

- [526] 卸棄: N/A
Disclaimer:
- [529] 限制: N/A
Limitation:
- [527] 條件: N/A
Condition:
其他: N/A
Others
- [220] 提交日期: 14-01-2022
Date of Filing:
- [320] 聲稱具有優先權的日期: N/A
Date of Priority Claimed:
- [310] 優先權申請編號: N/A
Priority Application Number:
- [340] 聲稱具有優先權 (部分): N/A
Priority Claim Details:
- [330] 優先權申請的
國家、地區、地方: N/A
Country, territory, area of
Priority Applications:

-
- [210] 商標申請編號: 305858399
Application No.:
- [540] 商標:
Mark:



THE ADMIRALS
CHINESE RESTAURANT

- [550] 商標種類: Ordinary
Mark Type:
一系列商標: NO
Series Mark:

- [571] 商標描述 : The applicant claims the colours Pantone 468C and 7505C as elements of the trade mark.
Mark Description:
- [730] 註冊申請人的姓名 / 名稱、地址 : RICH FOUNDATION DEVELOPMENT LIMITED (基裕發展有限公司)
Applicant(s) ' Name,Address: 3rd Floor, Wang Fai Industrial Building, No.29 Luk Hop Street, San Po Kong, Kowloon. HONG KONG
- [740/ 註冊申請人的送達地址 : HOWELL & CO.
750] Applicant's Address for ROOM 1202A, 12TH FLOOR, WING ON HOUSE, Service: 71 DES VOEUX ROAD CENTRAL, HONG KONG
- [511] 類別編號 : 43
Class(es) No(s) .:
- [511] 貨品 / 服務說明 : Class 43:
Specification: Provision of food and drink, catering services; café and cafeterias; coffee shops; restaurants; self-service restaurants; canteens; food halls; fast food restaurants; bar services; snack-bars; tea houses; cocktail lounges; takeaway food and drink services; cafes; cafeterias; bars; and cocktail lounges installed with audio and visual apparatus with sing along devices, all included in Class 43.
- [526] 卸棄 : N/A
Disclaimer:
- [529] 限制 : N/A
Limitation:
- [527] 條件 : N/A
Condition:
其他 : N/A
Others
- [220] 提交日期 : 14-01-2022
Date of Filing:
- [320] 聲稱具有優先權的日期 : N/A
Date of Priority Claimed:
- [310] 優先權申請編號 : N/A
Priority Application Number:
- [340] 聲稱具有優先權 (部分) : N/A
Priority Claim Details:
- [330] 優先權申請的 國家、地區、地方 : N/A
Country, territory, area of Priority Applications:
-
-

- [210] 商標申請編號 : 305858506
Application No.:

[540] 商標:

Mark:



[550] 商標種類:

Ordinary

Mark Type:

一系列商標:

NO

Series Mark:

[571] 商標描述:

N/A

Mark Description:

[730] 註冊申請人的姓名 / 名稱、地址:

On Yi Trading Limited

Applicant(s) '

Room B3, 5/F, Lladro Centre,

Name,Address:

72-80 Hoi Yuen Road, Kwun Tong, Kowloon,

HONG KONG

[740/ 註冊申請人的送達地址:

Create Good Consultant Limited

750] Applicant's Address for

Shop 211, 2 Floor, Wing Cheung Building,

Service:

6-14 Fu Shin Street, Tai Po, New Territories,

HONG KONG

[511] 類別編號:

43

Class(es) No(s) .:

[511] 貨品 / 服務說明:

Class 43:

Specification:

Restaurant services; Japanese restaurants; cafe restaurants; bar and cocktail lounge services; self-service restaurant services; services for providing food and drink, including restaurants, canteens, noodle shops, coffee shops, cafeterias and bars; dessert shops; provision of Japanese cuisine, bakery products, pastries and confectionery; providing udon, soba and Japanese noodles; advisory services relating to catering and banqueting services; banquet services; fast food shop and canteen services; provision of food and drink for dine-in, takeaway and home delivery; provision of catering services via an on-line computer network; decorating of food; child care services; bakery and cake shops services (other than retailing); boarding for animals and pets.

[526] 卸棄:

N/A

Disclaimer:

[529] 限制 : Limitation:	N/A
[527] 條件 : Condition:	N/A
其他 : Others	N/A
[220] 提交日期 : Date of Filing:	14-01-2022
[320] 聲稱具有優先權的日期 : Date of Priority Claimed:	N/A
[310] 優先權申請編號 : Priority Application Number:	N/A
[340] 聲稱具有優先權 (部分) : Priority Claim Details:	N/A
[330] 優先權申請的 國家、地區、地方 : Country, territory, area of Priority Applications:	N/A
<hr/>	
[210] 商標申請編號 : Application No.:	305858876
[540] 商標 : Mark:	WHEELS UP
[550] 商標種類 : Mark Type:	Ordinary
一系列商標 : Series Mark:	NO
[571] 商標描述 : Mark Description:	N/A
[730] 註冊申請人的姓名/名稱、地址 : Applicant(s) ' Name, Address:	Wheels Up Partners LLC 601 West 26th Street Suite 900 New York, New York 10001 UNITED STATES OF AMERICA
[740/ 註冊申請人的送達地址 : 750] Applicant's Address for Service:	CHINA PATENT AGENT (HONG KONG) LIMITED 22/F, Great Eagle Centre, 23 Harbour Road, Wanchai, HONG KONG
[511] 類別編號 : Class(es) No(s) .:	9, 25, 35, 39, 42, 43, 45
[511] 貨品/服務說明 : Specification:	Class 43: Booking of temporary accommodations; providing personalized information for members about hotels and temporary accommodations for travel via the Internet and providing information for the aforesaid via the internet.

[526] 卸棄 : Disclaimer:		N/A	
[529] 限制 : Limitation:		N/A	
[527] 條件 : Condition:		N/A	
其他 : Others		N/A	
[220] 提交日期 : Date of Filing:		14-01-2022	
[320] 聲稱具有優先權的日期 : Date of Priority Claimed:	[310] 優先權申請編號 : Priority Application No.:	[340] 聲稱具有優先權 (部分) : Priority Claim Details:	[330] 優先權申請的 國家、地區、地方 : Country, territory, area of Priority Applications:
28-07-2021	90852763	for goods listed in (B) in Class 9; for all services in Class 42.	UNITED STATES OF AMERICA
28-07-2021	90852774	for services listed in (B) in Class 35; for services listed in (A) in Class 39.	UNITED STATES OF AMERICA

[210] 商標申請編號 : 305859118
Application No.:

[540] 商標 :
Mark:



[550] 商標種類 : Ordinary
Mark Type:

一系列商標 : NO
Series Mark:

- [571] 商標描述 : The applicant claims the colours orange and blue as elements of the trade mark.
Mark Description:
- [730] 註冊申請人的姓名 / 名稱、地址 : HOMERCOLLECTION
Applicant(s) ' 119-125 Boulevard de Grenelle
Name,Address: Paris, 75015
FRANCE
- [740/ 註冊申請人的送達地址 : LONGTENG ENTERPRISE CONSULTATION MANAGEMENT
750] Applicant's Address for LIMITED
Service: UNIT B, 10/F, LEE MAY BUILDING
788-790 NATHAN ROAD MONGKOK KOWLOON
HONG KONG
- [511] 類別編號 : 29, 30, 43
Class(es) No(s) .:
- [511] 貨品 / 服務說明 : Class 43:
Specification: Food services; catering services
- [526] 卸棄 : N/A
Disclaimer:
- [529] 限制 : N/A
Limitation:
- [527] 條件 : N/A
Condition:
其他 : N/A
Others
- [220] 提交日期 : 14-01-2022
Date of Filing:
- [320] 聲稱具有優先權的日期 : N/A
Date of Priority Claimed:
- [310] 優先權申請編號 : N/A
Priority Application Number:
- [340] 聲稱具有優先權 (部分) : N/A
Priority Claim Details:
- [330] 優先權申請的 : N/A
國家、地區、地方 :
Country, territory, area of
Priority Applications:
-
-

- [210] 商標申請編號 : 305859622
Application No.:
- [540] 商標 :
Mark:

大葉

- [550] 商標種類： 一般商標
Mark Type:
一系列商標： 否
Series Mark:
- [571] 商標描述： 不適用
Mark Description:
- [730] 註冊申請人的姓名 / 名稱、地址： 香港萬膳餐飲集團有限公司
Applicant(s) ' 香港
Name,Address: 灣仔灣仔道 165-171 號
樂基中心 15 樓 1512 室
- [740/ 註冊申請人的送達地址： 世僑商務（香港）有限公司
750] Applicant's Address for 香港
Service: 灣仔灣仔道 165-171 號
樂基中心 15 樓 1512 室
- [511] 類別編號： 35,43
Class(es) No(s) .:
- [511] 貨品 / 服務說明： 類別 43:
Specification: 快餐館；酒吧服務；茶館；流動飲食供應；食物雕刻；餐廳；
日式料理餐廳；咖啡館；餐館；自助餐廳
- [526] 卸棄： 不適用
Disclaimer:
- [529] 限制： 不適用
Limitation:
- [527] 條件： 不適用
Condition:
其他： 不適用
Others
- [220] 提交日期： 17-01-2022
Date of Filing:
- [320] 聲稱具有優先權的日期： 不適用
Date of Priority Claimed:
- [310] 優先權申請編號： 不適用
Priority Application Number:
- [340] 聲稱具有優先權（部分）： 不適用
Priority Claim Details:
- [330] 優先權申請的 不適用
國家、地區、地方：
Country, territory, area of
Priority Applications:
-
- [210] 商標申請編號： 305859884
Application No.:

[540] 商標 :
Mark:



[550] 商標種類 : Ordinary
Mark Type:
一系列商標 : NO
Series Mark:

[571] 商標描述 : N/A
Mark Description:

[730] 註冊申請人的姓名 / 名稱、地址 : FUNG, Frances Adeline Wei Man D.
Applicant(s) ' 17/F, 17-19 Ashley Road,
Name,Address: Tsim Sha Tsui,
HONG KONG

[740/ 註冊申請人的送達地址 : 百信企業服務有限公司
750] Applicant's Address for 香港
Service: 金鐘金鐘道 89 號
力寶中心第一座 10 樓 1003 室

[511] 類別編號 : 43
Class(es) No(s) .:

[511] 貨品 / 服務說明 : Class 43:
Specification: Bar and restaurant services; cafe restaurants;
catering services for restaurants; dining and
restaurant services; providing fast food and
drink in cafeterias and restaurants; provision
of food and drink in a restaurant; provision
of restaurant services.

[526] 卸棄 : N/A
Disclaimer:

[529] 限制 : N/A
Limitation:

[527] 條件 : N/A
Condition:
其他 : N/A
Others

[220] 提交日期 : 17-01-2022
Date of Filing:

[320] 聲稱具有優先權的日期 : N/A
Date of Priority Claimed:

[310] 優先權申請編號 : N/A
Priority Application Number:

[340] 聲稱具有優先權 (部分): N/A
Priority Claim Details:
[330] 優先權申請的 N/A
國家、地區、地方:
Country, territory, area of
Priority Applications:

[210] 商標申請編號: 305860693
Application No.:

[540] 商標:
Mark:

如軒

[550] 商標種類: 一般商標
Mark Type:
一系列商標: 否
Series Mark:

[571] 商標描述: 不適用
Mark Description:

[730] 註冊申請人的姓名 / 名稱、地址: 佛山市五仁餐飲管理有限公司
Applicant(s) ' 中國
Name, Address: 廣東省佛山市

[740/ 註冊申請人的送達地址: HONG KONG DECENT INTELLECTUAL PROPERTY AGENT
750] Applicant's Address for LIMITED
Service: 香港

文咸東街 78 號
華東商業大廈三樓

[511] 類別編號: 35, 43
Class(es) No(s).:

[511] 貨品 / 服務說明: 類別 43:
Specification: 餐廳; 餐館; 茶館; 供應烏冬面和蕎麥面的餐館; 活動房屋出租; 養老院; 日間托兒所 (看孩子); 動物寄養; 飲水機出租; 烹飪設備出租。

[526] 卸棄: 不適用
Disclaimer:

[529] 限制: 不適用
Limitation:

[527] 條件: 不適用
Condition:

其他: 不適用
Others

[220] 提交日期 : 17-01-2022
Date of Filing:

[320] 聲稱具有優先權的日期 : 不適用
Date of Priority Claimed:

[310] 優先權申請編號 : 不適用
Priority Application Number:

[340] 聲稱具有優先權 (部分) : 不適用
Priority Claim Details:

[330] 優先權申請的
國家、地區、地方 : 不適用
Country, territory, area of
Priority Applications:

[210] 商標申請編號 : 305861476
Application No.:

[540] 商標 :
Mark:

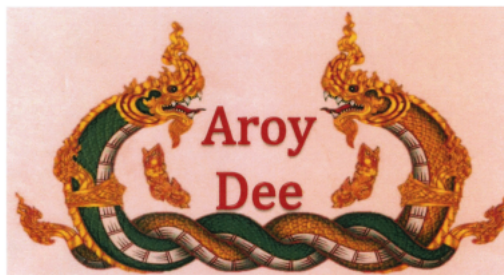

[550] 商標種類 : Ordinary
Mark Type:

一系列商標 : NO
Series Mark:

[571] 商標描述 : N/A
Mark Description:

[730] 註冊申請人的姓名 / 名稱、地址 : PUPUKIEO, THONGKAM
Applicant(s) ' G/F, 91(DD 196 LOT 916),
Name,Address: TAI SHUI HANG VILLAGE, SHA TIN, NT,
HONG KONG

[740/ 註冊申請人的送達地址 : ICAN BUSINESS SOLUTIONS COMPANNY
750] Applicant's Address for UNIT 1101B, 11/F., LIPPO SUN PLAZA,
Service: 28 CANTON ROAD, TSIMSHATSUI, KOWLOON,
HONG KONG

[511] 類別編號 : 43
Class(es) No(s) .:

[511] 貨品 / 服務說明 : Class 43:
Specification: Thai restaurant, bar services, cafés,
cafeterias, food sculpting, restaurants, self-
service restaurants, services for providing
food and drink, snack-bars

[526] 卸棄 : N/A
Disclaimer:

[529] 限制 : N/A
Limitation:

[527] 條件: N/A
Condition:
其他: N/A
Others

[220] 提交日期: 18-01-2022
Date of Filing:

[320] 聲稱具有優先權的日期: N/A
Date of Priority Claimed:

[310] 優先權申請編號: N/A
Priority Application Number:

[340] 聲稱具有優先權 (部分): N/A
Priority Claim Details:

[330] 優先權申請的
國家、地區、地方: N/A
Country, territory, area of
Priority Applications:

[210] 商標申請編號: 305861917
Application No.:

[540] 商標:
Mark:



美味不用等

[550] 商標種類: 一般商標
Mark Type:
一系列商標: 否
Series Mark:

[571] 商標描述: 不適用
Mark Description:

[730] 註冊申請人的姓名 / 名稱、地址: 美味不用等 (上海) 信息科技股份有限公司 (Seatnow
Applicant(s) ' (Shanghai) Information Technology Co., Ltd.)
Name, Address: 中國
中國 (上海) 自由貿易試驗區
祖沖之路 887 弄 88 號樓 302 室

[740/ 註冊申請人的送達地址 : 香港凱旋知識產權代理有限公司
750] Applicant's Address for 香港
Service: 九龍旺角煙廠街 9 號
興發商業大廈 7 樓 703 室

[511] 類別編號 : 9, 35, 36, 38, 42, 43
Class(es) No(s) .:

[511] 貨品 / 服務說明 : 類別 43:
Specification: 餐廳; 飯店; 關於膳食製備的信息和諮詢; 提供野營場地設施;
; 養老院; 日間托兒所 (看孩子); 動物寄養; 出租椅子、桌
子、桌布和玻璃器皿; 烹飪設備出租; 飲水機出租; 照明設備
出租; 外賣餐館。

[526] 卸棄 : 不適用
Disclaimer:

[529] 限制 : 不適用
Limitation:

[527] 條件 : 不適用
Condition:
其他 : 不適用
Others

[220] 提交日期 : 18-01-2022
Date of Filing:

[320] 聲稱具有優先權的日期 : 不適用
Date of Priority Claimed:

[310] 優先權申請編號 : 不適用
Priority Application Number:

[340] 聲稱具有優先權 (部分) : 不適用
Priority Claim Details:

[330] 優先權申請的 不適用
國家、地區、地方 :
Country, territory, area of
Priority Applications:

[210] 商標申請編號 : 305862051
Application No.:

[540] 商標：
Mark:

卡洛城市酒店

[550] 商標種類： 一般商標
Mark Type:
一系列商標： 否
Series Mark:

[571] 商標描述： 不適用
Mark Description:

[730] 註冊申請人的姓名 / 名稱、地址： 池紅楊
Applicant(s) ' 中國
Name, Address: 重慶市合川區
會江巷 38 號

[740/ 註冊申請人的送達地址： 東靈通國際品牌諮詢集團有限公司
750] Applicant's Address for 香港
Service: 灣仔軒尼詩道 338 號
北海中心 10 樓 E 室

[511] 類別編號： 43
Class(es) No(s) .:

[511] 貨品 / 服務說明： 類別 43:
Specification: 住所代理 (旅館、供膳寄宿處) ; 養老院 ; 提供野營場地設施 ; 寄宿處 ; 活動房屋出租 ; 飯堂 ; 動物寄養 ; 假日野營住宿服務 ; 預定臨時住所 ; 帳篷出租

[526] 卸棄： 不適用
Disclaimer:

[529] 限制： 不適用
Limitation:

[527] 條件： 不適用
Condition:

其他： 不適用
Others

[220] 提交日期： 19-01-2022
Date of Filing:

[320] 聲稱具有優先權的日期： 不適用
Date of Priority Claimed:

[310] 優先權申請編號： 不適用
Priority Application Number:

[340] 聲稱具有優先權 (部分): 不適用
Priority Claim Details:

[330] 優先權申請的 不適用
國家、地區、地方:
Country, territory, area of
Priority Applications:

[210] 商標申請編號: 305862952
Application No.:

[540] 商標:
Mark:



[550] 商標種類: Ordinary
Mark Type:
一系列商標: NO
Series Mark:

[571] 商標描述: N/A
Mark Description:

[730] 註冊申請人的姓名 / 名稱、地址: XP-FOOD
Applicant(s) ' c/o Gestem, 10 rue Stanislas Torrents,
Name, Address: 13006 MARSEILLE - 6ème Arrondissement
FRANCE

[740/ 註冊申請人的送達地址: CHINAHONGKONG IP LIMITED
750] Applicant's Address for 1502, 15/F, Capital Centre,
Service: 151 Gloucester Road, Wanchai
HONG KONG

[511] 類別編號: 43
Class(es) No(s) .:

[511] 貨品 / 服務說明: Class 43:
Specification: Restaurant services.

[526] 卸棄: N/A
Disclaimer:

[529] 限制: N/A
Limitation:

[527] 條件: N/A
Condition:

其他: N/A
Others

[220] 提交日期: 19-01-2022
Date of Filing:

[320] 聲稱具有優先權的日期: 22-07-2021

Date of Priority Claimed:	
[310] 優先權申請編號:	4787148
Priority Application Number:	
[340] 聲稱具有優先權 (部分):	N/A
Priority Claim Details:	
[330] 優先權申請的	FRANCE
國家、地區、地方:	
Country, territory, area of	
Priority Applications:	
<hr/>	
[210] 商標申請編號:	305863393
Application No.:	
[540] 商標:	
Mark:	
[550] 商標種類:	一般商標
Mark Type:	
一系列商標:	否
Series Mark:	
[571] 商標描述:	不適用
Mark Description:	
[730] 註冊申請人的姓名 / 名稱、地址:	盛唐飲食集團有限公司 (Prosperous Tang F&B Group Limited)
Applicant(s) 'Name, Address:	香港 九龍紅磡蕪湖街 70-74 號 達商業大廈 14 樓 C 室
[740/ 註冊申請人的送達地址:	盛唐飲食集團有限公司 Prosperous Tang F&B Group
750] Applicant's Address for Service:	Limited 香港 尖沙咀科學館道 1 號 康宏廣場南座 1003 室
[511] 類別編號:	29, 30, 31, 32, 35, 43
Class(es) No(s) .:	
[511] 貨品 / 服務說明:	類別 43:
Specification:	提供食物和飲料服務; 臨時住宿。
[526] 卸棄:	不適用
Disclaimer:	
[529] 限制:	不適用
Limitation:	
[527] 條件:	不適用
Condition:	
其他:	不適用
Others	

[220] 提交日期: 20-01-2022
Date of Filing:
[320] 聲稱具有優先權的日期: 不適用
Date of Priority Claimed:
[310] 優先權申請編號: 不適用
Priority Application Number:
[340] 聲稱具有優先權 (部分): 不適用
Priority Claim Details:
[330] 優先權申請的 不適用
國家、地區、地方:
Country, territory, area of
Priority Applications:

[210] 商標申請編號: 305865607
Application No.:

[540] 商標:
Mark:

Laxiaoya

[550] 商標種類: 一般商標
Mark Type:
一系列商標: 否
Series Mark:

[571] 商標描述: 不適用
Mark Description:

[730] 註冊申請人的姓名 / 名稱、地址: 辣小鴨食品有限公司
Applicant(s) ' 中國
Name, Address: 吉林省長春市

[740/ 註冊申請人的送達地址: LISHI INTELLECTUAL PROPERTY GROUP
750] Applicant's Address for (INTERNATIONAL) LIMITED
Service: 香港

九龍旺角花園街 2-16 號
好景商業中心 2709 室
16, 29, 30, 35, 43

[511] 類別編號: 16, 29, 30, 35, 43
Class(es) No(s) .:

[511] 貨品 / 服務說明: 類別 43:
Specification: 住所代理 (旅館、供膳寄宿處); 餐廳; 咖啡館; 飯店; 餐館
; 快餐館; 食物裝飾; 自助餐館; 關於膳食製備的信息和諮詢
; 私人廚師服務; 提供野營場地設施; 養老院; 日間托兒所 (看孩子); 動物寄養; 出租椅子、桌子、桌布和玻璃器皿

[526] 卸棄: 不適用
Disclaimer:

[529] 限制: 不適用
Limitation:

- [527] 條件: 不適用
Condition:
其他: 不適用
Others
- [220] 提交日期: 21-01-2022
Date of Filing:
- [320] 聲稱具有優先權的日期: 不適用
Date of Priority Claimed:
- [310] 優先權申請編號: 不適用
Priority Application Number:
- [340] 聲稱具有優先權 (部分): 不適用
Priority Claim Details:
- [330] 優先權申請的
國家、地區、地方: 不適用
Country, territory, area of
Priority Applications:

-
- [210] 商標申請編號: 305865922
Application No.:

- [540] 商標: A
Mark:



B



C



- [550] 商標種類 : 一般商標
 Mark Type:
 一系列商標 : 是
 Series Mark:
- [571] 商標描述 : 不適用
 Mark Description:
- [730] 註冊申請人的姓名 / 名稱、地址 : 陳綺君
 Applicant(s) ' 香港
 Name, Address: 元朗鳳攸北街 5-7 號
 順豐大廈地下 18 號舖
- [740/ 註冊申請人的送達地址 : 陳綺君
 750] Applicant's Address for 香港
 Service: 元朗大棠路
 崇正新村加蒼 233A
 30, 43
- [511] 類別編號 : 30, 43
 Class(es) No(s) .:
- [511] 貨品 / 服務說明 : 類別 43:
 Specification: 提供食物服務 (堂食及外賣)
- [526] 卸棄 : 不適用
 Disclaimer:
- [529] 限制 : 不適用
 Limitation:
- [527] 條件 : 不適用
 Condition:
 其他 : 不適用
 Others
- [220] 提交日期 : 22-01-2022
 Date of Filing:
- [320] 聲稱具有優先權的日期 : 不適用
 Date of Priority Claimed:
- [310] 優先權申請編號 : 不適用
 Priority Application Number:
- [340] 聲稱具有優先權 (部分) : 不適用

Priority Claim Details:

[330] 優先權申請的 不適用
國家、地區、地方：
Country, territory, area of
Priority Applications:

[210] 商標申請編號： 305866282
Application No.:

[540] 商標：
Mark:

[550] 商標種類： 一般商標
Mark Type:
一系列商標： 否
Series Mark:

[571] 商標描述： 不適用
Mark Description:

[730] 註冊申請人的姓名 / 名稱、地址：
Applicant(s) ' 江蘇七欣天餐飲管理連鎖有限公司
Name, Address: 中國
江蘇省蘇州市

[740/ 註冊申請人的送達地址：
750] Applicant's Address for 天標知識產權代理有限公司
Service: 香港
九龍尖沙咀加連威老道 14 號

[511] 類別編號： 加連威大廈 4 樓 A 座
Class(es) No(s) : 16, 43

[511] 貨品 / 服務說明： 類別 43：
Specification: 住所代理（旅館、供膳寄宿處）；備辦宴席；咖啡館；流動飲
食供應；飯店；餐館；酒吧服務；茶館；旅遊房屋出租；養老
院。

[526] 卸棄： 不適用
Disclaimer:

[529] 限制： 不適用
Limitation:

[527] 條件： 不適用
Condition:

其他： 不適用
Others

[220] 提交日期： 24-01-2022
Date of Filing:

[320] 聲稱具有優先權的日期： 不適用
Date of Priority Claimed:

[310] 優先權申請編號： 不適用

Priority Application Number:

[340] 聲稱具有優先權 (部分): 不適用

Priority Claim Details:

[330] 優先權申請的 不適用

國家、地區、地方:

Country, territory, area of

Priority Applications:

類別 Class 44

[210] 商標申請編號 : 305185819AA
Application No.:

[540] 商標 :
Mark:



[550] 商標種類 : Ordinary
Mark Type:

一系列商標 : NO

Series Mark:

[571] 商標描述 : N/A
Mark Description:

[730] 註冊申請人的姓名 / 名稱、地址 : JO MALONE INC.
Applicant(s) ' 767 FIFTH AVENUE, NEW YORK,
Name,Address: NEW YORK 10153,
UNITED STATES OF AMERICA

[740/ 註冊申請人的送達地址 : BAKER & MCKENZIE
750] Applicant's Address for 14TH FLOOR, ONE TAIKOO PLACE,
Service: 979 KING'S ROAD, QUARRY BAY,
HONG KONG

[511] 類別編號 : 3,35,44
Class(es) No(s) .:

[511] 貨品 / 服務說明 : Class 44:
Specification: Beauty consultation services in the selection
and use of cosmetics, fragrances, beauty aids,
personal care products, and bath, body and
beauty products.

[526] 卸棄 : N/A
Disclaimer:

[529] 限制 : N/A
Limitation:

[527] 條件 : N/A
Condition:

其他 : N/A
Others

[220] 提交日期 : 06-02-2020
Date of Filing:

[320]	聲稱具有優先權的日期： Date of Priority Claimed:	N/A
[310]	優先權申請編號： Priority Application Number:	N/A
[340]	聲稱具有優先權 (部分)： Priority Claim Details:	N/A
[330]	優先權申請的 國家、地區、地方： Country, territory, area of Priority Applications:	N/A
[210]	商標申請編號： Application No.:	305435730
[540]	商標： Mark:	
[550]	商標種類： Mark Type:	Ordinary
	一系列商標： Series Mark:	NO
[571]	商標描述： Mark Description:	N/A
[730]	註冊申請人的姓名 / 名稱、地址： Applicant(s) ' Name,Address:	R2 TECHNOLOGIES, INC. Suite 200, 2603 Camino Ramon San Ramon, California 94583 UNITED STATES OF AMERICA
[740/ 750]	註冊申請人的送達地址： Applicant's Address for Service:	ALBERT WAI-KIT CHAN INTELLECTUAL PROPERTY LIMITED Flat D, 10/F, Wing Cheong Commercial Building 23 Jervois Street, Sheung Wan HONG KONG
[511]	類別編號： Class(es) No(s) .:	10,44
[511]	貨品 / 服務說明： Specification:	Class 44: Medical services; Medical services using cryotherapy; Medical body care services using cryotherapy; Medical skin care services using cryotherapy; physician services; dermatologic services
[526]	卸棄： Disclaimer:	N/A
[529]	限制： Limitation:	N/A
[527]	條件： Condition:	N/A
	其他：	N/A

Others

[220] 提交日期:	02-11-2020
Date of Filing:	
[320] 聲稱具有優先權的日期:	N/A
Date of Priority Claimed:	
[310] 優先權申請編號:	N/A
Priority Application Number:	
[340] 聲稱具有優先權 (部分):	N/A
Priority Claim Details:	
[330] 優先權申請的 國家、地區、地方:	N/A
Country, territory, area of Priority Applications:	
<hr/>	
[210] 商標申請編號:	305435749
Application No.:	
[540] 商標:	
Mark:	
[550] 商標種類:	Ordinary
Mark Type:	
一系列商標:	NO
Series Mark:	
[571] 商標描述:	N/A
Mark Description:	
[730] 註冊申請人的姓名 / 名稱、地址:	R2 TECHNOLOGIES, INC. Suite 200, 2603 Camino Ramon San Ramon, California 94583 UNITED STATES OF AMERICA
Applicant(s) 'Name, Address:	
[740/ 註冊申請人的送達地址:	ALBERT WAI-KIT CHAN INTELLECTUAL PROPERTY
750] Applicant's Address for Service:	LIMITED Flat D, 10/F, Wing Cheong Commercial Building 23 Jervois Street, Sheung Wan HONG KONG
[511] 類別編號:	10, 44
Class(es) No(s) .:	
[511] 貨品 / 服務說明:	Class 44:
Specification:	Medical skin care services; Medical skin care services using cryotherapy; physician services, dermatologic services
[526] 卸棄:	N/A
Disclaimer:	
[529] 限制:	N/A
Limitation:	

[527] 條件: N/A
Condition:
其他: N/A
Others

[220] 提交日期: 02-11-2020
Date of Filing:

[320] 聲稱具有優先權的日期: N/A
Date of Priority Claimed:

[310] 優先權申請編號: N/A
Priority Application Number:

[340] 聲稱具有優先權 (部分): N/A
Priority Claim Details:

[330] 優先權申請的
國家、地區、地方: N/A
Country, territory, area of
Priority Applications:

[210] 商標申請編號: 305564881
Application No.:

[540] 商標:
Mark:

目經

EYE MERIDIAN

[550] 商標種類: 一般商標
Mark Type:
一系列商標: 否
Series Mark:

[571] 商標描述: 不適用
Mark Description:

[730] 註冊申請人的姓名 / 名稱、地址: 關斯桐
Applicant(s) ' 香港
Name, Address: 柴灣祥利街 18 號
祥達中心 3 樓 301 室

[740/ 註冊申請人的送達地址: 關斯桐
750] Applicant's Address for 香港
Service: 柴灣祥利街 18 號
祥達中心 3 樓 301 室

[511] 類別編號: 35, 44
Class(es) No(s) .:

[511] 貨品 / 服務說明: 類別 44:
Specification: 醫療服務; 獸醫服務; 人或動物的衛生和美容服務; 農業、水
產養殖、園藝和林業服務。

[526] 卸棄:	不適用
Disclaimer:	
[529] 限制:	不適用
Limitation:	
[527] 條件:	不適用
Condition:	
其他:	獲同意註冊, 編號 303371274。
Others	
[220] 提交日期:	17-03-2021
Date of Filing:	
[320] 聲稱具有優先權的日期:	不適用
Date of Priority Claimed:	
[310] 優先權申請編號:	不適用
Priority Application Number:	
[340] 聲稱具有優先權 (部分):	不適用
Priority Claim Details:	
[330] 優先權申請的	不適用
國家、地區、地方:	
Country, territory, area of	
Priority Applications:	

[210] 商標申請編號:	305614524
Application No.:	
[540] 商標:	A HENDERSON LAND
Mark:	B HENDERSON LAND
[550] 商標種類:	Ordinary
Mark Type:	
一系列商標:	YES
Series Mark:	
[571] 商標描述:	N/A
Mark Description:	
[730] 註冊申請人的姓名 / 名稱、地址:	Henderson Development Limited
Applicant(s) 'Name, Address:	72-76/F, Two International Finance Centre, 8 Finance Street, Central, HONG KONG
[740/ 註冊申請人的送達地址:	WOO KWAN LEE & LO
750] Applicant's Address for Service:	Room 2801, Sun Hung Kai Centre, 30 Harbour Road, Wanchai HONG KONG
[511] 類別編號:	35, 36, 37, 41, 43, 44
Class(es) No(s) .:	
[511] 貨品 / 服務說明:	Class 44:
Specification:	Health care services; medical services; hospital services; diagnostic radiology services for human; dentistry; in vitro

fertilization services; physiotherapy; medical services; hospitals; medical clinics; Chinese medicine clinics and service centres; dental health care services; mental health care services; clinics for acupuncture, physiotherapy, occupational therapy; provision of hygienic and beauty care; provision of sauna facilities; massage and provision of solarium, sun deck and hydrotherapy pool facilities; beauty spa services; foot spa services; health spa services; medical spa services; providing spa facilities; spa and bath treatment services; spa, sauna and steam room services; facial beauty treatment services; manicure and pedicure services; medical assistance; medical clinic services; nursing services; pharmacy services; physiotherapy, chiropody, osteopathy and massage services; sanatorium services; pet grooming; physiotherapy; salons and hairdressing services; hair care services; cosmetic dermatology services; medical services for non-invasive cosmetic treatment; cosmetic make up services; provision of information in relation to the aforesaid via the Internet, by telecommunication devices or electronic means or through the use of a mobile application; all included in Class 44.

- [526] 卸棄 : N/A
Disclaimer:
- [529] 限制 : N/A
Limitation:
- [527] 條件 : N/A
Condition:
其他 :
Others By consent, Nos. 300139464, 303139759, 303682990, 303683007, 303683016, 303683025, 303683034, 303683043, 303683052, 304240773, 305169628, 305169646, 305461164 and 305519386
- [220] 提交日期 : 04-05-2021
Date of Filing:
- [320] 聲稱具有優先權的日期 : N/A
Date of Priority Claimed:
- [310] 優先權申請編號 : N/A
Priority Application Number:
- [340] 聲稱具有優先權 (部分) : N/A
Priority Claim Details:
- [330] 優先權申請的
國家、地區、地方 : N/A
Country, territory, area of
Priority Applications:

- [210] 商標申請編號 : 305614533
Application No.:
- [540] 商標 : A **HENDERSON LAND**
Mark: 恒基兆業地產
B **HENDERSON LAND**
恒基兆業地產
C **HENDERSON LAND**
恒基兆業地產
D **HENDERSON LAND**
恒基兆業地產
- [550] 商標種類 : Ordinary
Mark Type:
一系列商標 : YES
Series Mark:
- [571] 商標描述 : N/A
Mark Description:
- [730] 註冊申請人的姓名 / 名稱、地址 : Henderson Development Limited
Applicant(s) ' 72-76/F, Two International Finance Centre,
Name,Address: 8 Finance Street, Central,
HONG KONG
- [740/ 註冊申請人的送達地址 : WOO KWAN LEE & LO
750] Applicant's Address for Room 2801, Sun Hung Kai Centre,
Service: 30 Harbour Road, Wanchai
HONG KONG
- [511] 類別編號 : 35,36,37,41,43,44
Class(es) No(s) .:
- [511] 貨品 / 服務說明 : Class 44:
Specification: Health care services; medical services;
hospital services; diagnostic radiology
services for human; dentistry; in vitro
fertilization services; physiotherapy; medical
services; hospitals; medical clinics; Chinese
medicine clinics and service centres; dental
health care services; mental health care
services; clinics for acupuncture,
physiotherapy, occupational therapy; provision
of hygienic and beauty care; provision of
sauna facilities; massage and provision of
solarium, sun deck and hydrotherapy pool
facilities; beauty spa services; foot spa
services; health spa services; medical spa
services; providing spa facilities; spa and
bath treatment services; spa, sauna and steam
room services; facial beauty treatment
services; manicure and pedicure services;
medical assistance; medical clinic services;

nursing services; pharmacy services; physiotherapy, chiropody, osteopathy and massage services; sanatorium services; pet grooming; physiotherapy; salons and hairdressing services; hair care services; cosmetic dermatology services; medical services for non-invasive cosmetic treatment; cosmetic make up services; provision of information in relation to the aforesaid via the Internet, by telecommunication devices or electronic means or through the use of a mobile application; all included in Class 44.
N/A

[526] 卸棄:

Disclaimer:

[529] 限制:

Limitation:

[527] 條件:

Condition:

其他:

Others

N/A

N/A

By consent, Nos. 300139464, 303139759, 303682990, 303683007, 303683016, 303683025, 303683034, 303683043, 303683052, 304240773, 305169628, 305169637, 305169646, 305169655, 305461164 and 305519386

[220] 提交日期:

Date of Filing:

04-05-2021

[320] 聲稱具有優先權的日期:

Date of Priority Claimed:

N/A

[310] 優先權申請編號:

Priority Application Number:

N/A

[340] 聲稱具有優先權 (部分):

Priority Claim Details:

N/A

[330] 優先權申請的

國家、地區、地方:

Country, territory, area of Priority Applications:

N/A

[210] 商標申請編號:

Application No.:

305708511

[540] 商標:

Mark:

A





B



- [550] 商標種類： 一般商標
Mark Type:
一系列商標： 是
Series Mark:
- [571] 商標描述： 不適用
Mark Description:
- [730] 註冊申請人的姓名 / 名稱、地址： UNION (GROUP) INVESTMENT LIMITED
Applicant(s) ' 香港
Name, Address: 九龍旺角
朗豪坊辦公大樓 50 樓
- [740/ 註冊申請人的送達地址： Leslie Lee
750] Applicant's Address for 香港
Service: 九龍旺角
朗豪坊辦公大樓 50 樓
- [511] 類別編號： 35, 44
Class(es) No(s) .:
- [511] 貨品 / 服務說明： 類別 44：
Specification: 醫療服務；獸醫服務；人或動物的衛生和美容服務；農業、水產養殖、園藝和林業服務。
- [526] 卸棄： 不適用
Disclaimer:
- [529] 限制： 不適用
Limitation:
- [527] 條件： 不適用
Condition:
其他： 獲同意註冊， 註冊編號： 304823938。
Others
- [220] 提交日期： 05-08-2021
Date of Filing:
- [320] 聲稱具有優先權的日期： 不適用
Date of Priority Claimed:
- [310] 優先權申請編號： 不適用
Priority Application Number:
- [340] 聲稱具有優先權 (部分)： 不適用
Priority Claim Details:
- [330] 優先權申請的 不適用
國家、地區、地方：
Country, territory, area of
Priority Applications:

[210] 商標申請編號： 305712697
Application No.:

[540] 商標： A  HENDERSON LAND DEVELOPMENT COMPANY LIMITED
恒基兆業地產有限公司

B  HENDERSON LAND DEVELOPMENT COMPANY LIMITED
恒基兆業地產有限公司

Mark:



- [550] 商標種類: Ordinary
 Mark Type: YES
 一系列商標: YES
 Series Mark:
- [571] 商標描述: N/A
 Mark Description:
- [730] 註冊申請人的姓名 / 名稱、地址: Henderson Development Limited
 Applicant(s) ' 72-76/F, Two International Finance Centre,
 Name, Address: 8 Finance Street, Central,
 HONG KONG
- [740/ 註冊申請人的送達地址: WOO KWAN LEE & LO
 750] Applicant's Address for Room 2801, Sun Hung Kai Centre,
 Service: 30 Harbour Road, Wanchai
 HONG KONG
- [511] 類別編號: 35, 36, 37, 41, 43, 44
 Class(es) No(s) .:
- [511] 貨品 / 服務說明: Class 44:
 Specification: Health care services; medical services;
 hospital services; diagnostic radiology
 services for human; dentistry; in vitro
 fertilization services; physiotherapy; medical
 services; hospitals; medical clinics; Chinese
 medicine clinics and service centres; dental
 health care services; mental health care
 services; clinics for acupuncture,
 physiotherapy, occupational therapy; provision
 of hygienic and beauty care; provision of
 sauna facilities; massage and provision of
 solarium, sun deck and hydrotherapy pool
 facilities; beauty spa services; foot spa
 services; health spa services; medical spa
 services; providing spa facilities; spa and
 bath treatment services; spa, sauna and steam
 room services; facial beauty treatment
 services; manicure and pedicure services;
 medical assistance; medical clinic services;
 nursing services; pharmacy services;
 physiotherapy, chiropody, osteopathy and
 massage services; sanatorium services; pet
 grooming; physiotherapy; salons and
 hairdressing services; hair care services;
 cosmetic dermatology services; medical
 services for non-invasive cosmetic treatment;
 cosmetic make up services; provision of
 information in relation to the aforesaid via
 the Internet, by telecommunication devices or
 electronic means or through the use of a
 mobile application; all included in Class 44.
- [526] 卸棄: N/A
 Disclaimer:

[529] 限制 :	N/A
Limitation:	
[527] 條件 :	N/A
Condition:	
其他 :	By consent, Nos. 300139464, 300517743,
Others	303139759, 303682990, 303683007, 303683016, 303683025, 303683034, 303683043, 303683052, 304240773, 305169628, 305169637, 305169646, 305169655, 305461164 and 305519386
[220] 提交日期 :	10-08-2021
Date of Filing:	
[320] 聲稱具有優先權的日期 :	N/A
Date of Priority Claimed:	
[310] 優先權申請編號 :	N/A
Priority Application Number:	
[340] 聲稱具有優先權 (部分) :	N/A
Priority Claim Details:	
[330] 優先權申請的	N/A
國家、地區、地方 :	
Country, territory, area of	
Priority Applications:	

[210] 商標申請編號 :	305712705
Application No.:	
[540] 商標 :	A
Mark:	 HENDERSON LAND GROUP 恒基兆業地產集團
	B
	 HENDERSON LAND GROUP 恒基兆業地產集團
	C
	 HENDERSON LAND GROUP 恒基兆業地產集團
	D
	 HENDERSON LAND GROUP 恒基兆業地產集團
[550] 商標種類 :	Ordinary
Mark Type:	
一系列商標 :	YES
Series Mark:	
[571] 商標描述 :	N/A
Mark Description:	
[730] 註冊申請人的姓名 / 名稱、地址 :	Henderson Development Limited
Applicant(s) ' Name, Address:	72-76/F, Two International Finance Centre, 8 Finance Street, Central, HONG KONG

- [740/ 註冊申請人的送達地址 : WOO KWAN LEE & LO
750] Applicant's Address for Room 2801, Sun Hung Kai Centre,
Service: 30 Harbour Road, Wanchai
HONG KONG
- [511] 類別編號 : 35,36,37,41,43,44
Class(es) No(s) .:
- [511] 貨品 / 服務說明 : Class 44:
Specification: Health care services; medical services;
hospital services; diagnostic radiology
services for human; dentistry; in vitro
fertilization services; physiotherapy; medical
services; hospitals; medical clinics; Chinese
medicine clinics and service centres; dental
health care services; mental health care
services; clinics for acupuncture,
physiotherapy, occupational therapy; provision
of hygienic and beauty care; provision of
sauna facilities; massage and provision of
solarium, sun deck and hydrotherapy pool
facilities; beauty spa services; foot spa
services; health spa services; medical spa
services; providing spa facilities; spa and
bath treatment services; spa, sauna and steam
room services; facial beauty treatment
services; manicure and pedicure services;
medical assistance; medical clinic services;
nursing services; pharmacy services;
physiotherapy, chiropody, osteopathy and
massage services; sanatorium services; pet
grooming; physiotherapy; salons and
hairstyling services; hair care services;
cosmetic dermatology services; medical
services for non-invasive cosmetic treatment;
cosmetic make up services; provision of
information in relation to the aforesaid via
the Internet, by telecommunication devices or
electronic means or through the use of a
mobile application; all included in Class 44.
- [526] 卸棄 : N/A
Disclaimer:
- [529] 限制 : N/A
Limitation:
- [527] 條件 : N/A
Condition:
其他 :
Others By consent, Nos. 300139464, 300517743,
303139759, 303682990, 303683007, 303683016,
303683025, 303683034, 303683043, 303683052,
304240773, 305169628, 305169637, 305169646,
305169655, 305461164 and 305519386
- [220] 提交日期 : 10-08-2021
Date of Filing:
- [320] 聲稱具有優先權的日期 : N/A
Date of Priority Claimed:
- [310] 優先權申請編號 : N/A
Priority Application Number:

[340] 聲稱具有優先權 (部分): N/A
Priority Claim Details:

[330] 優先權申請的 N/A
國家、地區、地方:
Country, territory, area of
Priority Applications:

[210] 商標申請編號: 305724775
Application No.:

[540] 商標: A
Mark:



悠悅醫療
C M Medical

B



悠悅醫療
C M Medical

[550] 商標種類: Ordinary
Mark Type:

一系列商標: YES
Series Mark:

[571] 商標描述: The applicant claims the colours blue and
Mark Description: green as elements of mark "B" in the series.

[730] 註冊申請人的姓名 / 名稱、地址 : JJC Hong Kong Limited
Applicant(s)' Name,Address: Flat/Rm 311, Hong Kong Pacific Centre,
28 Hankow Road, Tsim Sha Tsui,
HONG KONG

[740/ 註冊申請人的送達地址 : RIGHT IP LIMITED
750] Applicant's Address for 2002 Jupiter Tower
Service: 9 Jupiter Street
HONG KONG

[511] 類別編號 : 44
Class(es) No(s) .:

[511] 貨品 / 服務說明 : Class 44:
Specification: Alternative medicine services; clinic
services; health care; health center services;
health counselling; hospital services;
hygienic care for human beings; medical advice
for individuals with disabilities; medical
analysis services relating to the treatment of
person; medical assistance; medical clinic
services; medical equipment rental; medical
services; nursing home services; nursing,
medical; palliative care; physiotherapy /
physical therapy; public health services for
hygiene purposes; sanatorium services;
services of a psychologist; therapy services;
veterinary services.

[526] 卸棄 : N/A
Disclaimer:

[529] 限制 : N/A
Limitation:

[527] 條件 : N/A
Condition:
其他 : N/A
Others

[220] 提交日期 : 20-08-2021
Date of Filing:

[320] 聲稱具有優先權的日期 : N/A
Date of Priority Claimed:

[310] 優先權申請編號 : N/A
Priority Application Number:

[340] 聲稱具有優先權 (部分) : N/A
Priority Claim Details:

[330] 優先權申請的 N/A
國家、地區、地方 :
Country, territory, area of
Priority Applications:

[210] 商標申請編號 : 305777993
Application No.:

[540] 商標：
Mark:



[550] 商標種類： 一般商標
Mark Type:
一系列商標： 否
Series Mark:

[571] 商標描述： 不適用
Mark Description:

[730] 註冊申請人的姓名 / 名稱、地址： 謝詩瑩
Applicant(s) ' 香港
Name,Address: 上環皇后大道中 221-227 號
利基商業大廈 1 樓 B 室

[740/ 註冊申請人的送達地址： 謝詩瑩
750] Applicant's Address for 香港
Service: 上環皇后大道中 221-227 號
利基商業大廈 1 樓 B 室

[511] 類別編號： 44
Class(es) No(s) .:

[511] 貨品 / 服務說明： 類別 44：
Specification: 透過遊戲及藝術提供治療服務

[526] 卸棄： 不適用
Disclaimer:

[529] 限制： 不適用
Limitation:

[527] 條件： 不適用
Condition:
其他： 不適用
Others

[220] 提交日期： 21-10-2021
Date of Filing:

[320] 聲稱具有優先權的日期： 不適用
Date of Priority Claimed:

[310] 優先權申請編號： 不適用
Priority Application Number:

[340] 聲稱具有優先權 (部分)： 不適用

Priority Claim Details:

[330] 優先權申請的 不適用
國家、地區、地方：
Country, territory, area of
Priority Applications:

[210] 商標申請編號： 305796433
Application No.:

[540] 商標：
Mark:

FREQUENCY

[550] 商標種類： Ordinary
Mark Type:
一系列商標： NO
Series Mark:

[571] 商標描述： N/A
Mark Description:

[730] 註冊申請人的姓名 / 名稱、地址： Islestarr Holdings Limited
Applicant(s)' Unit 5 50 Brook Green,
Name, Address: Hammersmith, London W6 7BJ
UNITED KINGDOM

[740/ 註冊申請人的送達地址： LANE IP (HK) LIMITED
750] Applicant's Address for UNIT C 9/F NEICH TOWER,
Service: 128 GLOUCESTER ROAD, WANCHAI,
HONG KONG

[511] 類別編號： 3, 21, 35, 44
Class(es) No(s) .:

[511] 貨品 / 服務說明： Class 44:
Specification: Make up artist services; make-up services;
cosmetic make-up services; beauty care
services; beauty salon and beauty treatment
services; beauty therapy services and
treatments; healthcare, diet, exercise and
lifestyle wellness advisory services; cosmetic
treatment services for the hair; hair care,
hair colouring, hair styling and hair cutting
services; hairdressing salon services; advice
and consultancy services relating to the above
services.

[526] 卸棄： N/A
Disclaimer:

[529] 限制： N/A
Limitation:

[527] 條件 : N/A
Condition:
其他 : N/A
Others

[220] 提交日期 : 09-11-2021
Date of Filing:

[320] 聲稱具有優先權的日期 : 27-05-2021
Date of Priority Claimed:

[310] 優先權申請編號 : 18480967
Priority Application Number:

[340] 聲稱具有優先權 (部分) : N/A
Priority Claim Details:

[330] 優先權申請的
國家、地區、地方 : EUROPEAN UNION
Country, territory, area of
Priority Applications:

[210] 商標申請編號 : 305813668
Application No.:

[540] 商標 :
Mark:

KAMISMAX

[550] 商標種類 : Ordinary
Mark Type:
一系列商標 : NO
Series Mark:

[571] 商標描述 : N/A
Mark Description:

[730] 註冊申請人的姓名 / 名稱、地址 : INVADE Co., Ltd.
Applicant(s) ' GINZA SIX 11F, 6-10-1, Ginza,
Name,Address: Chuo-ku, Tokyo,
JAPAN

[740/ 註冊申請人的送達地址 :
750] Applicant's Address for MAYER BROWN
Service: 16th-19th Floors, Prince's Building,
10 Chater Road, Central,
HONG KONG

[511] 類別編號 : 3,9,35,41,42,44
Class(es) No(s) .:

[511] 貨品 / 服務說明 : Class 44:
Specification: Beauty salons; barbershops; providing
information about beauty; providing
information about hairdressing; advisory
services relating to beauty care; advisory
services relating to hairdressing; providing
bath houses; massage and therapeutic shiatsu
massage; chiropractic; moxibustion; treatment

of dislocated joints, sprain, bone fractures [Judo-seifuku]; bodywork therapy; acupuncture; providing medical information; physical examination; dietary and nutritional guidance; animal breeding; veterinary services; beautification for animals; garden tree planting; garden or flower bed care; fertilizer spreading; weed killing; vermin exterminating [for agriculture, aquaculture, horticulture or forestry]; nursing care; rental of potted plants; farming equipment rental; rental of medical apparatus and instruments; rental of fishing equipment and instruments for commercial fishing purposes; rental of apparatus and instruments for use in beauty salons or barbers' shops; rental of lawnmowers.

- [526] 卸棄 : N/A
Disclaimer:
- [529] 限制 : N/A
Limitation:
- [527] 條件 : N/A
Condition:
其他 : N/A
Others
- [220] 提交日期 : 25-11-2021
Date of Filing:
- [320] 聲稱具有優先權的日期 : 09-11-2021
Date of Priority Claimed:
- [310] 優先權申請編號 : 2021-139384
Priority Application Number:
- [340] 聲稱具有優先權 (部分) : N/A
Priority Claim Details:
- [330] 優先權申請的
國家、地區、地方 : JAPAN
Country, territory, area of
Priority Applications:

-
- [210] 商標申請編號 : 305815297
Application No.:

- [540] 商標 :
Mark:

BIENVI

- [550] 商標種類 : Ordinary
Mark Type:
一系列商標 : NO
Series Mark:

- [571] 商標描述 : N/A
Mark Description:
- [730] 註冊申請人的姓名 / 名稱、地址 : GlaxoSmithKline Consumer Healthcare (UK) IP
Applicant(s) ' Limited
Name,Address: 980 Great West Road,
Brentford, Middlesex, TW8 9GS, England
UNITED KINGDOM
- [740/ 註冊申請人的送達地址 : WILKINSON & GRIST
750] Applicant's Address for 6th Floor, Prince's Building
Service: Chater Road, Central
HONG KONG
- [511] 類別編號 : 3, 5, 9, 10, 21, 29, 30, 32, 35, 36, 41, 42, 44
Class(es) No(s) .:
- [511] 貨品 / 服務說明 : Class 44:
Specification: Medical, hygienic and beauty care; healthcare
services; provision of medical information and
services; information provided to patients and
healthcare professionals concerning
pharmaceutical products, vaccines, medical
diseases and disorders and related treatments
via the Internet; gene and cell therapy;
medical and psychological counselling
services; medical and health care services.
- [526] 卸棄 : N/A
Disclaimer:
- [529] 限制 : N/A
Limitation:
- [527] 條件 : N/A
Condition:
- 其他 : N/A
Others
- [220] 提交日期 : 29-11-2021
Date of Filing:
- [320] 聲稱具有優先權的日期 : 03-06-2021
Date of Priority Claimed:
- [310] 優先權申請編號 : 83440
Priority Application Number:
- [340] 聲稱具有優先權 (部分) : for Classes 3, 5, 9, 10, 21, 29, 30, 32, 35,
Priority Claim Details: 41, 42 and 44
- [330] 優先權申請的 JAMAICA
國家、地區、地方 :
Country, territory, area of
Priority Applications:
-
-

- [210] 商標申請編號 : 305815314
Application No.:

[540] 商標 :	
Mark:	HALEON
[550] 商標種類 :	Ordinary
Mark Type:	
一系列商標 :	NO
Series Mark:	
[571] 商標描述 :	N/A
Mark Description:	
[730] 註冊申請人的姓名 / 名稱、地址 :	GlaxoSmithKline Consumer Healthcare (UK) IP Limited
Applicant(s) ' Name,Address:	980 Great West Road, Brentford, Middlesex, TW8 9GS, England, UNITED KINGDOM
[740/ 註冊申請人的送達地址 :	WILKINSON & GRIST
750] Applicant's Address for Service:	6th Floor, Prince's Building Chater Road, Central HONG KONG
[511] 類別編號 :	3, 5, 9, 10, 21, 29, 30, 32, 35, 36, 41, 42, 44
Class(es) No(s) .:	
[511] 貨品 / 服務說明 :	Class 44:
Specification:	Medical, hygienic and beauty care; healthcare services; provision of medical information and services; information provided to patients and healthcare professionals concerning pharmaceutical products, vaccines, medical diseases and disorders and related treatments via the Internet; gene and cell therapy; medical and psychological counselling services; medical and health care services; all the aforementioned services excluding services relating to surgical and/or professional vision care.
[526] 卸棄 :	N/A
Disclaimer:	
[529] 限制 :	N/A
Limitation:	
[527] 條件 :	N/A
Condition:	
其他 :	N/A
Others	
[220] 提交日期 :	29-11-2021
Date of Filing:	
[320] 聲稱具有優先權的日期 :	03-06-2021
Date of Priority Claimed:	
[310] 優先權申請編號 :	83438
Priority Application Number:	
[340] 聲稱具有優先權 (部分) :	for Classes 3, 5, 9, 10, 21, 29, 30, 32, 35, 41, 42 and 44
Priority Claim Details:	
[330] 優先權申請的國家、地區、地方 :	JAMAICA

Country, territory, area of
Priority Applications:

[210] 商標申請編號 : 305825692
Application No.:

[540] 商標 : A
Mark: 

[540] 商標 : B
Mark: 

[550] 商標種類 : Ordinary
Mark Type:
一系列商標 : YES
Series Mark:

[571] 商標描述 : N/A
Mark Description:

[730] 註冊申請人的姓名 / 名稱、地址 : GlaxoSmithKline Consumer Healthcare (UK) IP
Applicant(s) ' Limited
Name,Address: 980 Great West Road,
Brentford, Middlesex, TW8 9GS, England,
UNITED KINGDOM

[740/ 註冊申請人的送達地址 : WILKINSON & GRIST
750] Applicant's Address for 6th Floor, Prince's Building
Service: Chater Road, Central
HONG KONG

[511] 類別編號 : 3, 5, 9, 10, 21, 29, 30, 32, 35, 36, 41, 42, 44
Class(es) No(s) .:

[511] 貨品 / 服務說明 : Class 44:
Specification: Medical, hygienic and beauty care; healthcare
services; provision of medical information and
services; information provided to patients and
healthcare professionals concerning
pharmaceutical products, vaccines, medical
diseases and disorders and related treatments
via the Internet; gene and cell therapy;
medical and psychological counselling
services; medical and health care services.

[526] 卸棄 : N/A
Disclaimer:

[529] 限制 : N/A
Limitation:

[527] 條件 :	N/A
Condition:	
其他 :	N/A
Others	
[220] 提交日期 :	08-12-2021
Date of Filing:	
[320] 聲稱具有優先權的日期 :	N/A
Date of Priority Claimed:	
[310] 優先權申請編號 :	N/A
Priority Application Number:	
[340] 聲稱具有優先權 (部分) :	N/A
Priority Claim Details:	
[330] 優先權申請的 國家、地區、地方 :	N/A
Country, territory, area of Priority Applications:	
<hr/>	
[210] 商標申請編號 :	305825700
Application No.:	
[540] 商標 :	
Mark:	<h1>赫力昂</h1>
[550] 商標種類 :	Ordinary
Mark Type:	
一系列商標 :	NO
Series Mark:	
[571] 商標描述 :	N/A
Mark Description:	
[730] 註冊申請人的姓名 / 名稱、地址 :	GlaxoSmithKline Consumer Healthcare (UK) IP Limited
Applicant(s) ' Name, Address:	980 Great West Road, Brentford, Middlesex, TW8 9GS, England, UNITED KINGDOM
[740/ 註冊申請人的送達地址 :	WILKINSON & GRIST
750] Applicant's Address for Service:	6th Floor, Prince's Building Chater Road, Central HONG KONG
[511] 類別編號 :	3, 5, 9, 10, 21, 29, 30, 32, 35, 36, 41, 42, 44
Class(es) No(s) .:	
[511] 貨品 / 服務說明 :	Class 44:
Specification:	Medical, hygienic and beauty care; healthcare services; provision of medical information and services; information provided to patients and healthcare professionals concerning pharmaceutical products, vaccines, medical diseases and disorders and related treatments

via the Internet; gene and cell therapy; medical and psychological counselling services; medical and health care services; all the aforementioned services excluding services relating to surgical and/or professional vision care.

- [526] 卸棄 : N/A
Disclaimer:
- [529] 限制 : N/A
Limitation:
- [527] 條件 : N/A
Condition:
其他 : N/A
Others
- [220] 提交日期 : 08-12-2021
Date of Filing:
- [320] 聲稱具有優先權的日期 : N/A
Date of Priority Claimed:
- [310] 優先權申請編號 : N/A
Priority Application Number:
- [340] 聲稱具有優先權 (部分) : N/A
Priority Claim Details:
- [330] 優先權申請的
國家、地區、地方 : N/A
Country, territory, area of
Priority Applications:

-
- [210] 商標申請編號 : 305836690
Application No.:
- [540] 商標 :
Mark:



芳 | 香 | 寶 | 貝

- [550] 商標種類 : 一般商標
Mark Type:

- 一系列商標 : 否
Series Mark:
- [571] 商標描述 : 不適用
Mark Description:
- [730] 註冊申請人的姓名 / 名稱、地址 : 蔡嘉瑩
Applicant(s) ' 香港
Name, Address: 旺角西洋菜南街 5 號
好望角大廈 16 樓 3 室
- [740/ 註冊申請人的送達地址 : 蔡嘉瑩
750] Applicant's Address for 香港
Service: 旺角西洋菜南街 5 號
好望角大廈 16 樓 3 室
- [511] 類別編號 : 3, 44
Class(es) No(s) .:
- [511] 貨品 / 服務說明 : 類別 44:
Specification: 推拿 ; 香薰治療 ; 美容院 ; 按摩。
- [526] 卸棄 : 不適用
Disclaimer:
- [529] 限制 : 不適用
Limitation:
- [527] 條件 : 不適用
Condition:
其他 : 不適用
Others
- [220] 提交日期 : 20-12-2021
Date of Filing:
- [320] 聲稱具有優先權的日期 : 不適用
Date of Priority Claimed:
- [310] 優先權申請編號 : 不適用
Priority Application Number:
- [340] 聲稱具有優先權 (部分) : 不適用
Priority Claim Details:
- [330] 優先權申請的 不適用
國家、地區、地方 :
Country, territory, area of
Priority Applications:
-
-

- [210] 商標申請編號 : 305843827
Application No.:
- [540] 商標 : **GYM JONG KOOK**
Mark:

[550] 商標種類 : Ordinary
 Mark Type:
 一系列商標 : NO
 Series Mark:

[571] 商標描述 : N/A
 Mark Description:

[730] 註冊申請人的姓名／名稱、地址 : TURBO JK COMPANY
 Applicant(s) ' 301ho, 32, Nonhyeon-ro 157-gil
 Name,Address: Gangnam-gu, Seoul 06033
 REPUBLIC OF KOREA

[740/ 註冊申請人的送達地址 : BKIP Limited
 750] Applicant's Address for Unit 2202, 22/F, Causeway Bay Plaza I
 Service: 489 Hennessy Road, Causeway Bay
 HONG KONG

[511] 類別編號 : 9,16,25,28,29,32,35,38,44
 Class(es) No(s) .:

[511] 貨品／服務說明 : Class 44:
 Specification: Advisory services relating to health;
 providing information relating to dietary and
 nutritional guidance; health care services
 provided by a health spa; advisory services
 relating to weight control; bodywork therapy;
 body art; beauty treatment services;
 consultancy provided via the Internet in the
 field of body and beauty care; health spa
 services for health and wellness of the body
 and spirit; sports massage; nutrition and
 dietetic consultancy; massage; psychological
 and lifestyle counselling; psychological
 counselling services in the field of sports;
 branding of animals; conducting of
 psychological assessments and examinations;
 providing information about agriculture,
 horticulture, and forestry services; fish
 farming services; veterinary services; flower
 arranging.

[526] 卸棄 : N/A
 Disclaimer:

[529] 限制 : N/A
 Limitation:

[527] 條件 : N/A
 Condition:
 其他 : N/A
 Others

[220] 提交日期 : 28-12-2021
 Date of Filing:

[320] [310] [340] [330]
 聲稱具有優先權的日期 : 優先權申請編號 : 聲稱具有優先權 (部分) : 優先權申請的
 Date of Priority Priority Application Priority Claim 國家、地區、地方 :
 Claimed: No.: Details: Country, territory,
 area of Priority
 Applications:

28-06-2021	40-2021-0132782	for Class 9	REPUBLIC OF KOREA
28-06-2021	40-2021-0132786	for Class 16	REPUBLIC OF KOREA
28-06-2021	40-2021-0132785	for Class 25	REPUBLIC OF KOREA
28-06-2021	40-2021-0132784	for Class 28	REPUBLIC OF KOREA
28-06-2021	40-2021-0132788	for Class 29	REPUBLIC OF KOREA
28-06-2021	40-2021-0132787	for Class 32	REPUBLIC OF KOREA
28-06-2021	40-2021-0132783	for Class 35	REPUBLIC OF KOREA
28-06-2021	40-2021-0132781	for Class 38	REPUBLIC OF KOREA
28-06-2021	40-2021-0132780	for Class 44	REPUBLIC OF KOREA

[210] 商標申請編號 : 305845591

Application No.:

[540] 商標 :

Mark:

METASCULPT

[550] 商標種類 : Ordinary

Mark Type:

一系列商標 :

NO

Series Mark:

[571] 商標描述 : N/A

Mark Description:

[730] 註冊申請人的姓名 / 名稱、地址 :

GIORGIO ARMANI S.p.A.

Applicant(s) '

Via Borgonuovo 11

Name, Address:

Milano 20121

ITALY

[740/ 註冊申請人的送達地址 :

WOO KWAN LEE & LO

750] Applicant's Address for

Room 2801, Sun Hung Kai Centre,

Service:

30 Harbour Road, Wanchai

HONG KONG

[511] 類別編號 :

3, 44

Class(es) No(s) .:

[511] 貨品 / 服務說明 : Specification:	Class 44: Beauty care services; massage services.
[526] 卸棄 : Disclaimer:	N/A
[529] 限制 : Limitation:	N/A
[527] 條件 : Condition: 其他 : Others	N/A N/A
[220] 提交日期 : Date of Filing:	29-12-2021
[320] 聲稱具有優先權的日期 : Date of Priority Claimed:	N/A
[310] 優先權申請編號 : Priority Application Number:	N/A
[340] 聲稱具有優先權 (部分) : Priority Claim Details:	N/A
[330] 優先權申請的 國家、地區、地方 : Country, territory, area of Priority Applications:	N/A

[210] 商標申請編號 : Application No.:	305846545
[540] 商標 : Mark:	A

The logo for 'pureplus' is displayed in a light gray, lowercase, sans-serif font. The 'p' and 'l' are slightly larger and more prominent than the other letters. The logo is centered horizontally and appears to be a watermark or a faint background element.

B



- [550] 商標種類： 一般商標
Mark Type:
- 一系列商標： 是
Series Mark:
- [571] 商標描述： 在本系列商標中的商標“B”，申請人聲稱橙色及淺棕色為商標的多於一個要素。
Mark Description:
- [730] 註冊申請人的姓名 / 名稱、地址： Pure Plus Holdings Limited
Applicant(s) ' 香港
Name, Address: 九龍尖沙咀金巴利道 40 號
MW Plaza 17 樓
- [740/ 註冊申請人的送達地址： BKIP Limited
750] Applicant's Address for 香港
Service: 銅鑼灣軒尼詩道 489 號
銅鑼灣廣場 1 期 22 樓 2202 室
- [511] 類別編號： 44
Class(es) No(s) .:
- [511] 貨品 / 服務說明： 類別 44：
Specification: 面部護理服務；美容服務；美容纖體中心服務；美容諮詢顧問；美容纖體治療服務；按摩；整形外科；脫毛服務；減肥服務；護膚美容服務；醫療儀器租賃；醫療服務；獸醫服務；人或動物的衛生和美容服務；農業、水產養殖、園藝和林業服務。
- [526] 卸棄： 不適用
Disclaimer:
- [529] 限制： 不適用
Limitation:
- [527] 條件： 不適用
Condition:
- 其他： 不適用
Others
- [220] 提交日期： 30-12-2021
Date of Filing:
- [320] 聲稱具有優先權的日期： 不適用
Date of Priority Claimed:
- [310] 優先權申請編號： 不適用
Priority Application Number:

[340] 聲稱具有優先權 (部分): 不適用
Priority Claim Details:

[330] 優先權申請的 不適用
國家、地區、地方:
Country, territory, area of
Priority Applications:

[210] 商標申請編號: 305851080
Application No.:

[540] 商標:
Mark:

A



B



[550] 商標種類: 一般商標
Mark Type:
一系列商標: 是
Series Mark:

[571] 商標描述: 不適用
Mark Description:

[730] 註冊申請人的姓名 / 名稱、地址: UNION (GROUP) INVESTMENT LIMITED
Applicant(s) ' Suite 07-09, L21, Langham Place Office Tower,
Name, Address: 8 Argyle Street,
Mongkok,
HONG KONG

[740/ 註冊申請人的送達地址: Amy Leung

750] Applicant's Address for 香港
Service: 旺角
朗豪坊辦公大樓 50 樓
5, 35, 44

[511] 類別編號: 5, 35, 44
Class(es) No(s) .:

[511] 貨品 / 服務說明: 類別 44:
Specification: 醫療服務; 獸醫服務; 人或動物的衛生和美容服務; 農業、水
產養殖、園藝和林業服務。

[526] 卸棄: 不適用
Disclaimer:

[529] 限制: 不適用
Limitation:

[527] 條件: 不適用
Condition:

其他: 不適用
Others

[220] 提交日期 : 06-01-2022
Date of Filing:
[320] 聲稱具有優先權的日期 : 不適用
Date of Priority Claimed:
[310] 優先權申請編號 : 不適用
Priority Application Number:
[340] 聲稱具有優先權 (部分) : 不適用
Priority Claim Details:
[330] 優先權申請的 不適用
國家、地區、地方 :
Country, territory, area of
Priority Applications:

[210] 商標申請編號 : 305852737
Application No.:
[540] 商標 :
Mark:

JMsolution

[550] 商標種類 : Ordinary
Mark Type:
一系列商標 : NO
Series Mark:
[571] 商標描述 : N/A
Mark Description:
[730] 註冊申請人的姓名 / 名稱、地址 : GP CLUB CO., LTD.
Applicant(s) ' 1222-12F CHANGGANG BD,
Name,Address: 86, MAPO-DAERO, MAPO-GU, SEOUL
REPUBLIC OF KOREA
[740/ 註冊申請人的送達地址 : HONG KONG VICTORY INTELLECTUAL PROPERTY AGENT
750] Applicant's Address for CO., LIMITED
Service: RM 703,7/F PROSPER COMM BLDG,
9 YIN CHONG ST, MONGKOK, KLN,
HONG KONG
[511] 類別編號 : 8,16,18,20,24,31,42,44
Class(es) No(s) .:

[511] 貨品 / 服務說明 :
Specification: Class 44:
Plastic surgery; Medical clinic services;
Beauty salon services; Massage; Rental of
sanitary installations; Gardening; Consultancy
services relating to cosmetics; Medical
services; Visagists' services; Massage therapy
services for animals; Artificial insemination
services for animals; Animal breeding; Animal
grooming; Beauty care services for animals.

[526] 卸棄 :
Disclaimer: N/A

[529] 限制 :
Limitation: N/A

[527] 條件 :
Condition: N/A
其他 :
Others N/A

[220] 提交日期 : 07-01-2022
Date of Filing:

[320] 聲稱具有優先權的日期 : N/A
Date of Priority Claimed:

[310] 優先權申請編號 : N/A
Priority Application Number:

[340] 聲稱具有優先權 (部分) : N/A
Priority Claim Details:

[330] 優先權申請的
國家、地區、地方 :
Country, territory, area of
Priority Applications: N/A

[210] 商標申請編號 : 305852863
Application No.:

[540] 商標 :
Mark:

SUNDAY RILEY

[550] 商標種類 : Ordinary
Mark Type:
一系列商標 : NO
Series Mark:

[571] 商標描述 : N/A
Mark Description:

[730] 註冊申請人的姓名 / 名稱、地址 :
Applicant(s) ' Sunday Riley Modern Skincare, LLC
Name,Address: 4444 Westheimer Rd, Suite G305
Houston, Texas 77027
UNITED STATES OF AMERICA

[740/ 註冊申請人的送達地址 : BIRD & BIRD
750] Applicant's Address for 6/F, The Annex, Central Plaza
Service: 18 Harbour Road
HONG KONG

[511] 類別編號 : 3,5,41,44
Class(es) No(s) .:

[511] 貨品 / 服務說明 : Class 44:
Specification: Beauty treatments; beauty consultancy; beauty care; beauty therapy treatments; providing information about beauty; human hygiene and beauty care; consultancy provided via the Internet in the field of body, hair and beauty care; hair treatment, hair restoration; hair care services; personal hair removal services; consultation services relating to skin care; consulting services relating to health care; diet planning and supervision; dietary advice; health assessment surveys; health consultancy; providing consultation in the field of beauty, cosmetics, nutrition and health; information on beauty, cosmetics, nutrition and health provided via a website.

[526] 卸棄 : N/A
Disclaimer:

[529] 限制 : N/A
Limitation:

[527] 條件 : N/A
Condition:
其他 : N/A
Others

[220] 提交日期 : 07-01-2022
Date of Filing:

[320] 聲稱具有優先權的日期 : N/A
Date of Priority Claimed:

[310] 優先權申請編號 : N/A
Priority Application Number:

[340] 聲稱具有優先權 (部分) : N/A
Priority Claim Details:

[330] 優先權申請的 N/A
國家、地區、地方 :
Country, territory, area of
Priority Applications:

[210] 商標申請編號 : 305853655
Application No.:

[540] 商標 :
Mark:



[550] 商標種類 : Ordinary
Mark Type:
一系列商標 : NO
Series Mark:

[571] 商標描述 : N/A
Mark Description:

[730] 註冊申請人的姓名 / 名稱、地址 : BEST VISION CONSULTANTS GROUP CO., LIMITED
Applicant(s) ' Flat / Rm 1103 8 Jordan Road,
Name, Address: Yau Ma Tei
HONG KONG

[740/ 註冊申請人的送達地址 : AC Business Services Limited
750] Applicant's Address for Rm 1608, 16/F, Apec Plaza
Service: 49 Hoi Yuen Road, Kwun Tong
HONG KONG

[511] 類別編號 : 9, 44
Class(es) No(s) .:

[511] 貨品 / 服務說明 : Class 44:
Specification: Optical Service; eyes examination service,
myopia control; orthokeratology; contact lens;
all included in class 44.

[526] 卸棄 : N/A
Disclaimer:

[529] 限制 : N/A
Limitation:

[527] 條件 : N/A
Condition:
其他 : N/A
Others

[220] 提交日期 : 10-01-2022
Date of Filing:

[320] 聲稱具有優先權的日期 : N/A
Date of Priority Claimed:

[310] 優先權申請編號 : N/A
Priority Application Number:

[340] 聲稱具有優先權 (部分) : N/A
Priority Claim Details:

[330] 優先權申請的
國家、地區、地方 : N/A
Country, territory, area of
Priority Applications:

[210]	商標申請編號 : Application No.:	305853673
[540]	商標 : Mark:	
[550]	商標種類 : Mark Type:	Ordinary
	一系列商標 : Series Mark:	NO
[571]	商標描述 : Mark Description:	N/A
[730]	註冊申請人的姓名 / 名稱、地址 : Applicant(s)' Name,Address:	BEST VISION CONSULTANTS GROUP CO., LIMITED Flat / Rm 1103 8 Jordan Road, Yau Ma Tei HONG KONG
[740/750]	註冊申請人的送達地址 : Applicant's Address for Service:	AC Business Services Limited Rm 1608, 16/F, Apec Plaza 49 Hoi Yuen Road, Kwun Tong HONG KONG
[511]	類別編號 : Class(es) No(s) .:	9, 44
[511]	貨品 / 服務說明 : Specification:	Class 44: Optical Service; eyes examination service, myopia control; orthokeratology; contact lens; all included in class 44.
[526]	卸棄 : Disclaimer:	N/A
[529]	限制 : Limitation:	N/A
[527]	條件 : Condition:	N/A
	其他 : Others	N/A
[220]	提交日期 : Date of Filing:	10-01-2022
[320]	聲稱具有優先權的日期 : Date of Priority Claimed:	N/A
[310]	優先權申請編號 : Priority Application Number:	N/A
[340]	聲稱具有優先權 (部分) : Priority Claim Details:	N/A
[330]	優先權申請的 國家、地區、地方 : Country, territory, area of Priority Applications:	N/A

[210]	商標申請編號 : Application No.:	305853727
[540]	商標 : Mark:	
[550]	商標種類 : Mark Type:	一般商標
	一系列商標 : Series Mark:	否
[571]	商標描述 : Mark Description:	不適用
[730]	註冊申請人的姓名 / 名稱、地址 : Applicant(s) ' Name, Address:	全民醫療有限公司 香港 九龍尖沙咀中間道 15 號 H Zentre 1 樓 109 室
[740/750]	註冊申請人的送達地址 : Applicant's Address for Service:	港之傑商業服務有限公司 香港 九龍彌敦道 713 號 銀高國際大廈 17 樓 C 室
[511]	類別編號 : Class(es) No(s) .:	44
[511]	貨品 / 服務說明 : Specification:	類別 44: 醫療診所服務; 醫療服務; 醫療按摩服務; 醫療看護服務; 醫療諮詢服務; 醫療設備出租; 醫療護理; 醫療輔助; 人或動物的衛生和美容服務。
[526]	卸棄 : Disclaimer:	不適用
[529]	限制 : Limitation:	不適用
[527]	條件 : Condition:	不適用
	其他 : Others	不適用
[220]	提交日期 : Date of Filing:	10-01-2022
[320]	聲稱具有優先權的日期 : Date of Priority Claimed:	不適用
[310]	優先權申請編號 : Priority Application Number:	不適用
[340]	聲稱具有優先權 (部分) : Priority Claim Details:	不適用
[330]	優先權申請的 國家、地區、地方 :	不適用

Country, territory, area of
Priority Applications:

[210]	商標申請編號 : Application No.:	305856067
[540]	商標 : Mark:	
[550]	商標種類 : Mark Type:	一般商標
	一系列商標 : Series Mark:	否
[571]	商標描述 : Mark Description:	申請人聲稱藍色、綠色及白色為商標的多於一個要素。
[730]	註冊申請人的姓名 / 名稱、地址 : Applicant(s)' Name, Address:	北京華醫網科技股份有限公司 中國 北京市海澱區 北四環西路 9 號 2106
[740/ 750]	註冊申請人的送達地址 : Applicant's Address for Service:	標準香港企業註冊服務有限公司 香港 九龍旺角彌敦道 678 號 華僑商業中心 15C
[511]	類別編號 : Class(es) No(s) .:	41, 44
[511]	貨品 / 服務說明 : Specification:	類別 44: 醫藥諮詢; 遠程醫學服務; 健康諮詢; 療養院; 飲食營養指導 ; 美容服務; 動物養殖; 水產養殖服務; 農業、園藝及林業服 務; 園藝學; 滅害蟲 (為農業、水產養殖業、園藝或林業目的) ; 衛生設備出租; 配鏡服務。
[526]	卸棄 : Disclaimer:	不適用
[529]	限制 : Limitation:	不適用
[527]	條件 : Condition:	不適用
	其他 : Others	不適用
[220]	提交日期 : Date of Filing:	12-01-2022
[320]	聲稱具有優先權的日期 : Date of Priority Claimed:	不適用
[310]	優先權申請編號 : Priority Application Number:	不適用

[340]	聲稱具有優先權 (部分): Priority Claim Details:	不適用
[330]	優先權申請的 國家、地區、地方: Country, territory, area of Priority Applications:	不適用
[210]	商標申請編號: Application No.:	305857192
[540]	商標: Mark:	THE ORDINARY BUFFET
[550]	商標種類: Mark Type: 一系列商標: Series Mark:	Ordinary NO
[571]	商標描述: Mark Description:	N/A
[730]	註冊申請人的姓名 / 名稱、地址: Applicant(s)' Name,Address:	Deciem Beauty Group Inc. 15 Fraser Avenue Toronto, Ontario M6K 1Y7 CANADA
[740/ 750]	註冊申請人的送達地址: Applicant's Address for Service:	DEACONS 5th Floor, Alexandra House Central HONG KONG
[511]	類別編號: Class(es) No(s) .:	3, 35, 44
[511]	貨品 / 服務說明: Specification:	Class 44: Beauty consultation services in the selection and use of cosmetics.
[526]	卸棄: Disclaimer:	N/A
[529]	限制: Limitation:	N/A
[527]	條件: Condition: 其他: Others	N/A N/A
[220]	提交日期: Date of Filing:	13-01-2022
[320]	聲稱具有優先權的日期: Date of Priority Claimed:	N/A
[310]	優先權申請編號: Priority Application Number:	N/A

[340]	聲稱具有優先權 (部分): Priority Claim Details:	N/A
[330]	優先權申請的 國家、地區、地方: Country, territory, area of Priority Applications:	N/A
[210]	商標申請編號: Application No.:	305859433
[540]	商標: Mark:	音韻樂心靈 Melody in Mind
[550]	商標種類: Mark Type:	Ordinary
	一系列商標: Series Mark:	NO
[571]	商標描述: Mark Description:	N/A
[730]	註冊申請人的姓名 / 名稱、地址: Applicant(s)' Name, Address:	Hong Kong Breast Cancer Foundation Limited 22/F, Jupiter Tower 9 Jupiter Street, North Point HONG KONG
[740/ 750]	註冊申請人的送達地址: Applicant's Address for Service:	Pansy Leung Tang & Chua Solicitors 21/F, Regent Centre, No.88 Queen's Road Central HONG KONG
[511]	類別編號: Class(es) No(s) .:	16, 36, 41, 42, 44, 45
[511]	貨品 / 服務說明: Specification:	Class 44: Charitable services, namely, providing medical services to those in need; medical services; veterinary services; hygienic and beauty care for human beings or animals; agriculture, horticulture and forestry services.
[526]	卸棄: Disclaimer:	N/A
[529]	限制: Limitation:	N/A
[527]	條件: Condition:	N/A
	其他: Others	N/A
[220]	提交日期: Date of Filing:	17-01-2022
[320]	聲稱具有優先權的日期: Date of Priority Claimed:	N/A

[310] 優先權申請編號 : N/A
Priority Application Number:

[340] 聲稱具有優先權 (部分) : N/A
Priority Claim Details:

[330] 優先權申請的 N/A
國家、地區、地方 :
Country, territory, area of
Priority Applications:

[210] 商標申請編號 : 305860828
Application No.:

[540] 商標 :
Mark:

RIOS Architecture

[550] 商標種類 : Ordinary
Mark Type:
一系列商標 : NO
Series Mark:

[571] 商標描述 : N/A
Mark Description:

[730] 註冊申請人的姓名 / 名稱、地址 : Rios, Inc.
Applicant(s) ' 3101 Exposition Pl, Los Angeles, California
Name,Address: 90018
UNITED STATES OF AMERICA

[740/ 註冊申請人的送達地址 : CHINAHONGKONG IP LIMITED
750] Applicant's Address for 1502, 15/F, Capital Centre,
Service: 151 Gloucester Road, Wanchai
HONG KONG

[511] 類別編號 : 42,44
Class(es) No(s) .:

[511] 貨品 / 服務說明 : Class 44:
Specification: Landscape design; horticulture; landscape
gardening; gardening; flower arranging;
landscape design for others.

[526] 卸棄 : N/A
Disclaimer:

[740/ 註冊申請人的送達地址 : CHINAHONGKONG IP LIMITED
750] Applicant's Address for 1502, 15/F, Capital Centre,
Service: 151 Gloucester Road, Wanchai
HONG KONG

[511] 類別編號 : 42,44
Class(es) No(s) .:

[511] 貨品 / 服務說明 : Class 44:
Specification: Landscape design; horticulture; landscape
gardening; gardening; flower arranging;
landscape design for others.

[526] 卸棄 : N/A
Disclaimer:

[529] 限制 : N/A
Limitation:

[527] 條件 : N/A
Condition:
其他 : N/A
Others

[220] 提交日期 : 17-01-2022
Date of Filing:

[320] 聲稱具有優先權的日期 : N/A
Date of Priority Claimed:

[310] 優先權申請編號 : N/A
Priority Application Number:

[340] 聲稱具有優先權 (部分) : N/A
Priority Claim Details:

[330] 優先權申請的 N/A
國家、地區、地方 :
Country, territory, area of
Priority Applications:

[210] 商標申請編號 : 305861223
Application No.:

[540] 商標 :
Mark:



[550] 商標種類 : 一般商標
Mark Type:
一系列商標 : 否
Series Mark:

- [571] 商標描述 : 申請人聲稱褐色和綠色為商標的多於一個要素。
Mark Description:
- [730] 註冊申請人的姓名 / 名稱、地址 : LIFE YOUNG MEDICAL GROUP LIMITED
Applicant(s) ' RM 08, 28/F, GREENFIELD TOWER, CONCORDIA
Name, Address: PLAZA,
No. 1 SCIENCE MUSEUM ROAD, TST EAST, KOWLOON
HONG KONG
- [740/ 註冊申請人的送達地址 : LIFE YOUNG MEDICAL GROUP LIMITED
750] Applicant's Address for RM 08, 28/F, GREENFIELD TOWER, CONCORDIA
Service: PLAZA,
No. 1 SCIENCE MUSEUM ROAD, TST EAST, KOWLOON
HONG KONG
- [511] 類別編號 : 5, 35, 44
Class(es) No(s) .:
- [511] 貨品 / 服務說明 : 類別 44:
Specification: 醫療服務 ; 美容服務。
- [526] 卸棄 : 不適用
Disclaimer:
- [529] 限制 : 不適用
Limitation:
- [527] 條件 : 不適用
Condition:
其他 : 不適用
Others
- [220] 提交日期 : 18-01-2022
Date of Filing:
- [320] 聲稱具有優先權的日期 : 不適用
Date of Priority Claimed:
- [310] 優先權申請編號 : 不適用
Priority Application Number:
- [340] 聲稱具有優先權 (部分) : 不適用
Priority Claim Details:
- [330] 優先權申請的 不適用
國家、地區、地方 :
Country, territory, area of
Priority Applications:
-
-

- [210] 商標申請編號 : 305863401
Application No.:
- [540] 商標 : A
Mark:

艾丽美

B

艾麗美

[550]	商標種類: Mark Type:	Ordinary
	一系列商標: Series Mark:	YES
[571]	商標描述: Mark Description:	N/A
[730]	註冊申請人的姓名 / 名稱、地址: Applicant(s) 'Name, Address:	ELEMIS USA, INC. 1140 Broadway, Suite 1601 New York, NY 10001 UNITED STATES OF AMERICA
[740/ 750]	註冊申請人的送達地址: Applicant's Address for Service:	LEHMAN, LEE & XU PATENT AND TRADEMARK AGENTS LIMITED Suite 3313, Tower One, Times Square, 1 Matheson Street, Causeway Bay, HONG KONG
[511]	類別編號: Class(es) No(s) .:	3, 35, 44
[511]	貨品 / 服務說明: Specification:	Class 44: Beauty salon services; Hair salon services; Nail care services; Manicuring; Massage; Body waxing services for the human body; Sauna services; Solarium services; Beauty and cosmetic make-up services; Provision of medical services; Animal healthcare services; Human hygiene and beauty care; Hygienic and beauty care for animals; Medical assistance; Plastic surgery; Hospital services; Health spa services; Alternative medicine services; Agriculture, horticulture and forestry services; Spa services; Aromatherapy services.
[526]	卸棄: Disclaimer:	N/A
[529]	限制: Limitation:	N/A
[527]	條件: Condition:	N/A
	其他: Others	N/A
[220]	提交日期: Date of Filing:	20-01-2022
[320]	聲稱具有優先權的日期: Date of Priority Claimed:	N/A
[310]	優先權申請編號: Priority Application Number:	N/A
[340]	聲稱具有優先權 (部分): Priority Claim Details:	N/A
[330]	優先權申請的	N/A

國家、地區、地方：

Country, territory, area of
Priority Applications:

[210] 商標申請編號： 305865643
Application No.:

[540] 商標：
Mark:

愉愈

[550] 商標種類： 一般商標
Mark Type:
一系列商標： 否
Series Mark:

[571] 商標描述： 不適用
Mark Description:

[730] 註冊申請人的姓名 / 名稱、地址：
Applicant(s) ' Name, Address: 名聲有限公司
香港
九龍尖沙咀漆咸圍 6&8 號
紀德樓地下 8 號舖

[740/ 註冊申請人的送達地址：
750] Applicant's Address for Service: 中港知識產權有限公司
香港
灣仔告士打道 151 號
資本中心 15 樓 1502 室
35, 41, 44

[511] 類別編號：
Class(es) No(s) .:

[511] 貨品 / 服務說明：
Specification: 類別 44:
按摩；心理諮詢；療養院；健康顧問服務；美容服務；桑拿浴
服務；足底按摩服務；修指甲服務；穴位按摩療法；寵物美容
服務。

[526] 卸棄：
Disclaimer: 不適用

[529] 限制：
Limitation: 不適用

[527] 條件：
Condition: 不適用

其他：
Others: 不適用

[220] 提交日期：
Date of Filing: 21-01-2022

[320] 聲稱具有優先權的日期：
Date of Priority Claimed: 不適用

- [310] 優先權申請編號: 不適用
Priority Application Number:
- [340] 聲稱具有優先權 (部分): 不適用
Priority Claim Details:
- [330] 優先權申請的 不適用
國家、地區、地方:
Country, territory, area of
Priority Applications:

-
- [210] 商標申請編號: 305866291
Application No.:
- [540] 商標:
Mark:

簡蝶

- [550] 商標種類: 一般商標
Mark Type:
- 一系列商標: 否
Series Mark:
- [571] 商標描述: 不適用
Mark Description:
- [730] 註冊申請人的姓名 / 名稱、地址: 陳思彤
Applicant(s) ' 中國
Name, Address: 四川省青川縣
青溪鎮金橋村一組
- [740/ 註冊申請人的送達地址: 東靈通國際品牌諮詢集團有限公司
750] Applicant's Address for 香港
Service: 灣仔軒尼詩道 338 號
北海中心 10 樓 E 室
- [511] 類別編號: 44
Class(es) No(s) .:
- [511] 貨品 / 服務說明: 類別 44:
Specification: 護理院; 醫療按摩; 醫療診所服務; 配藥諮詢; 美容師服務;
藥劑師配藥服務; 醫院; 醫療輔助; 理療; 芳香治療

[526] 卸棄:	不適用
Disclaimer:	
[529] 限制:	不適用
Limitation:	
[527] 條件:	不適用
Condition:	
其他:	不適用
Others	
[220] 提交日期:	24-01-2022
Date of Filing:	
[320] 聲稱具有優先權的日期:	不適用
Date of Priority Claimed:	
[310] 優先權申請編號:	不適用
Priority Application Number:	
[340] 聲稱具有優先權 (部分):	不適用
Priority Claim Details:	
[330] 優先權申請的	不適用
國家、地區、地方:	
Country, territory, area of	
Priority Applications:	

[210] 商標申請編號:	305868046
Application No.:	
[540] 商標:	A
Mark:	

FOREVER
LUCKY
BEAUTY

B

FOREVER LUCKY BEAUTY

[550] 商標種類 :	Ordinary
Mark Type:	
一系列商標 :	YES
Series Mark:	
[571] 商標描述 :	N/A
Mark Description:	
[730] 註冊申請人的姓名 / 名稱、地址 :	Kwong Pui Ling trading as Forever Lucky Beauty
Applicant(s) 'Name,Address:	CL130 - CL132, Western Solo, 133-134 Connaught Road West, Sai Ying Pun, HONG KONG
[740/ 註冊申請人的送達地址 :	ACCOLADE IP LIMITED
750] Applicant's Address for Service:	10/F, Fu Fai Comm. Ctr., 27 Hillier Street, Sheung Wan, HONG KONG
[511] 類別編號 :	44
Class(es) No(s) .:	
[511] 貨品 / 服務說明 :	Class 44:
Specification:	Nail salon services; beauty care and beauty salon services; medical clinic services.
[526] 卸棄 :	N/A
Disclaimer:	
[529] 限制 :	N/A
Limitation:	
[527] 條件 :	N/A
Condition:	
其他 :	N/A
Others	
[220] 提交日期 :	25-01-2022
Date of Filing:	
[320] 聲稱具有優先權的日期 :	N/A
Date of Priority Claimed:	
[310] 優先權申請編號 :	N/A
Priority Application Number:	
[340] 聲稱具有優先權 (部分) :	N/A
Priority Claim Details:	
[330] 優先權申請的	N/A

國家、地區、地方：

Country, territory, area of

Priority Applications:

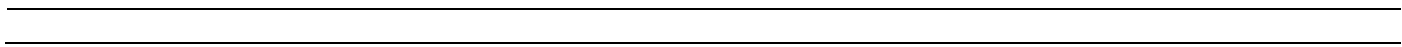

類別 Class 45

[210]	商標申請編號 : Application No.:	305085144
[540]	商標 : Mark:	SEEK
[550]	商標種類 : Mark Type:	Ordinary
	一系列商標 : Series Mark:	NO
[571]	商標描述 : Mark Description:	N/A
[730]	註冊申請人的姓名 / 名稱、地址 : Applicant(s) ' Name, Address:	Seek Limited 541 St Kilda Road Melbourne Victoria 3004 AUSTRALIA
[740/ 750]	註冊申請人的送達地址 : Applicant's Address for Service:	SO KEUNG YIP & SIN Room 1009-1012, 10/F., Nan Fung Tower, No. 173 Des Voeux Road Central HONG KONG
[511]	類別編號 : Class(es) No(s) .:	9, 16, 35, 36, 37, 38, 41, 42, 45
[511]	貨品 / 服務說明 : Specification:	Class 45: Personal and social services rendered by others to meet the needs of individuals; social networking services; online social networking services; security services; security services for individuals; employment screening services (security checking); consultancy, information and advisory services regarding the aforementioned services
[526]	卸棄 : Disclaimer:	N/A
[529]	限制 : Limitation:	N/A
[527]	條件 : Condition:	N/A
	其他 : Others	By consent, No. 304489868
[220]	提交日期 : Date of Filing:	16-10-2019
[320]	聲稱具有優先權的日期 : Date of Priority Claimed:	N/A
[310]	優先權申請編號 : Priority Application Number:	N/A
[340]	聲稱具有優先權 (部分) : Priority Claim Details:	N/A

[330] 優先權申請的 N/A
國家、地區、地方：
Country, territory, area of
Priority Applications:

[210] 商標申請編號： 305085153
Application No.:

[540] 商標：
Mark:



[550] 商標種類： Ordinary
Mark Type:
一系列商標： NO
Series Mark:

[571] 商標描述： N/A
Mark Description:

[730] 註冊申請人的姓名 / 名稱、地址： Seek Limited
Applicant(s) ' 541 St Kilda Road
Name, Address: Melbourne Victoria 3004
AUSTRALIA

[740/ 註冊申請人的送達地址： SO KEUNG YIP & SIN
750] Applicant's Address for Room 1009-1012, 10/F., Nan Fung Tower,
Service: No. 173 Des Voeux Road Central
HONG KONG

[511] 類別編號： 9, 16, 35, 36, 37, 38, 41, 42, 45
Class(es) No(s) .:

[511] 貨品 / 服務說明： Class 45:
Specification: Personal and social services rendered by
others to meet the needs of individuals;
social networking services; online social
networking services; security services;
security services for individuals; employment
screening services (security checking);
consultancy, information and advisory services
regarding the aforementioned services

[526] 卸棄： N/A
Disclaimer:

[529] 限制： N/A
Limitation:

[527] 條件： N/A
Condition:

其他： By consent, No. 304489868
Others

[220] 提交日期： 16-10-2019
Date of Filing:

[320] 聲稱具有優先權的日期 : N/A
Date of Priority Claimed:
[310] 優先權申請編號 : N/A
Priority Application Number:
[340] 聲稱具有優先權 (部分) : N/A
Priority Claim Details:
[330] 優先權申請的 N/A
國家、地區、地方 :
Country, territory, area of
Priority Applications:

[210] 商標申請編號 : 305623768
Application No.:

[540] 商標 : A
Mark:



B



[550] 商標種類 : Ordinary
Mark Type:
一系列商標 : YES
Series Mark:

- [571] 商標描述 : The applicant claims the colours navy blue and white as elements of mark A in the series.
Mark Description:
- [730] 註冊申請人的姓名 / 名稱、地址 : CliftonLarsonAllen, LLP
Applicant(s) ' Suite 300, 220 South Sixth Street
Name,Address: Minneapolis, MINNESOTA 554021926
UNITED STATES OF AMERICA
- [740/ 註冊申請人的送達地址 : MARKS & CLERK
750] Applicant's Address for Level 9, Cyberport 1
Service: 100 Cyberport Road, Pok Fu Lam
HONG KONG
- [511] 類別編號 : 9,16,35,36,41,42,45
Class(es) No(s) .:
- [511] 貨品 / 服務說明 : Class 45:
Specification: Litigation support services, namely, legal discovery and pre-trial analysis, and expert witness services in legal matters in the fields of litigation or forensic investigations; litigation support services; all included in Class 45.
- [526] 卸棄 : N/A
Disclaimer:
- [529] 限制 : N/A
Limitation:
- [527] 條件 : N/A
Condition:
- 其他 : N/A
Others
- [220] 提交日期 : 13-05-2021
Date of Filing:
- [320] 聲稱具有優先權的日期 : 13-04-2021
Date of Priority Claimed:
- [310] 優先權申請編號 : 90642163
Priority Application Number:
- [340] 聲稱具有優先權 (部分) : For mark "A" in the series.
Priority Claim Details:
- [330] 優先權申請的 UNITED STATES OF AMERICA
國家、地區、地方 :
Country, territory, area of
Priority Applications:
-
-

- [210] 商標申請編號 : 305636845AA
Application No.:

- [540] 商標 :
Mark:

CKH IOD

- [550] 商標種類 : Ordinary
Mark Type:

一系列商標 : NO
Series Mark:

[571] 商標描述 : N/A
Mark Description:

[730] 註冊申請人的姓名 / 名稱、地址 : Palmerston Limited
Applicant(s) ' 1st Floor, Sixty Circular Road,
Name,Address: Douglas,
ISLE OF MAN

[740/ 註冊申請人的送達地址 : Hutchison Whampoa Agents Limited
750] Applicant's Address for 48th Floor, Cheung Kong Center,
Service: 2 Queen's Road Central
HONG KONG

[511] 類別編號 : 9,35,38,42,45
Class(es) No(s) .:

[511] 貨品 / 服務說明 : Class 45:
Specification: Licensing of computer software, technology and
computer programs; licensing of wireless
communication system; all the aforesaid
services relating to the operation of
telecommunications networks; none of the
aforesaid services in relation to business
information, business training, business
networking, professional development courses,
professional development events and setting
standards for corporate governance.

[526] 卸棄 : N/A
Disclaimer:

[529] 限制 : N/A
Limitation:

[527] 條件 : N/A
Condition:
其他 : N/A
Others

[220] 提交日期 : 26-05-2021
Date of Filing:

[320] 聲稱具有優先權的日期 : 04-05-2021
Date of Priority Claimed:

[310] 優先權申請編號 : UK00003636391
Priority Application Number:

[340] 聲稱具有優先權 (部分) : N/A
Priority Claim Details:

[330] 優先權申請的 UNITED KINGDOM
國家、地區、地方 :
Country, territory, area of
Priority Applications:

[210] 商標申請編號 : 305636845AB
Application No.:

[540] 商標 :	
Mark:	CKHIOD
[550] 商標種類 :	Ordinary
Mark Type:	
一系列商標 :	NO
Series Mark:	
[571] 商標描述 :	N/A
Mark Description:	
[730] 註冊申請人的姓名 / 名稱、地址 :	Palmerston Limited
Applicant(s) ' Name,Address:	1st Floor, Sixty Circular Road, Douglas, ISLE OF MAN
[740/ 註冊申請人的送達地址 :	Hutchison Whampoa Agents Limited
750] Applicant's Address for Service:	48th Floor, Cheung Kong Center, 2 Queen's Road Central HONG KONG
[511] 類別編號 :	9, 35, 38, 42, 45
Class(es) No(s) .:	
[511] 貨品 / 服務說明 :	Class 45:
Specification:	Licensing of computer software, technology and computer programs; licensing of wireless communication system; all the aforesaid services relating to the operation of telecommunications networks; none of the aforesaid services in relation to business information, business training, business networking, professional development courses, professional development events and setting standards for corporate governance.
[526] 卸棄 :	N/A
Disclaimer:	
[529] 限制 :	N/A
Limitation:	
[527] 條件 :	N/A
Condition:	
其他 :	N/A
Others	
[220] 提交日期 :	26-05-2021
Date of Filing:	
[320] 聲稱具有優先權的日期 :	04-05-2021
Date of Priority Claimed:	
[310] 優先權申請編號 :	UK00003636391
Priority Application Number:	
[340] 聲稱具有優先權 (部分) :	N/A
Priority Claim Details:	
[330] 優先權申請的	UNITED KINGDOM
國家、地區、地方 :	
Country, territory, area of Priority Applications:	

[210] 商標申請編號 : 305652739

Application No.:

[540] 商標 :

Mark:

MEETSOCIAL

[550] 商標種類 : 一般商標

Mark Type:

一系列商標 :

否

Series Mark:

[571] 商標描述 : 不適用

Mark Description:

[730] 註冊申請人的姓名 / 名稱、地址 :

飛書深諾數字科技 (上海) 股份有限公司

Applicant(s)'

中國

Name, Address:

上海市普陀區

中江路 879 弄 28 號樓 4036 室

[740/ 註冊申請人的送達地址 :

柯伍陳律師事務所

750] Applicant's Address for

香港

Service:

中環康樂廣場 8 號

交易廣場第三期 19 樓

[511] 類別編號 :

9, 35, 36, 38, 41, 42, 45

Class(es) No(s) .:

[511] 貨品 / 服務說明 :

類別 45:

Specification:

實體安全保衛諮詢; 社交陪伴; 服裝出租; 交友服務; 在綫社交網絡服務; 個人背景調查; 婚姻介紹; 計劃和安排婚禮服務; 互聯網域名租賃; 知識產權許可。

[526] 卸棄 :

不適用

Disclaimer:

[529] 限制 :

不適用

Limitation:

[527] 條件 :

不適用

Condition:

其他 :

不適用

Others

[220] 提交日期 :

09-06-2021

Date of Filing:

[320] 聲稱具有優先權的日期 :

不適用

Date of Priority Claimed:

[310] 優先權申請編號 :

不適用

Priority Application Number:

[340] 聲稱具有優先權 (部分) :

不適用

Priority Claim Details:

[330] 優先權申請的

不適用

國家、地區、地方：

Country, territory, area of

Priority Applications:

[210]	商標申請編號： Application No.:	305659552
[540]	商標： Mark:	FIRST ADVISORY
[550]	商標種類： Mark Type:	Ordinary
	一系列商標： Series Mark:	NO
[571]	商標描述： Mark Description:	N/A
[730]	註冊申請人的姓名 / 名稱、地址： Applicant(s) ' Name, Address:	FIRST ADVISORY BETEILIGUNGS TRUST REG. Wuhrstrasse 6 9490 Vaduz LIECHTENSTEIN
[740/750]	註冊申請人的送達地址： Applicant's Address for Service:	WILKINSON & GRIST 6th Floor, Prince's Building Chater Road, Central HONG KONG
[511]	類別編號： Class(es) No(s) .:	35, 36, 45
[511]	貨品 / 服務說明： Specification:	Class 45: Legal services.
[526]	卸棄： Disclaimer:	N/A
[529]	限制： Limitation:	N/A
[527]	條件： Condition:	N/A
	其他： Others	N/A
[220]	提交日期： Date of Filing:	17-06-2021
[320]	聲稱具有優先權的日期： Date of Priority Claimed:	N/A
[310]	優先權申請編號： Priority Application Number:	N/A
[340]	聲稱具有優先權 (部分)： Priority Claim Details:	N/A
[330]	優先權申請的	N/A

國家、地區、地方：

Country, territory, area of

Priority Applications:

[210]	商標申請編號： Application No.:	305659561
[540]	商標： Mark:	FIRST ADVISORY GROUP
[550]	商標種類： Mark Type:	Ordinary
	一系列商標： Series Mark:	NO
[571]	商標描述： Mark Description:	N/A
[730]	註冊申請人的姓名 / 名稱、地址： Applicant(s) ' Name, Address:	FIRST ADVISORY BETEILIGUNGS TRUST REG. Wuhrstrasse 6 9490 Vaduz LIECHTENSTEIN
[740/750]	註冊申請人的送達地址： Applicant's Address for Service:	WILKINSON & GRIST 6th Floor, Prince's Building Chater Road, Central HONG KONG
[511]	類別編號： Class(es) No(s) .:	35, 36, 45
[511]	貨品 / 服務說明： Specification:	Class 45: Legal services.
[526]	卸棄： Disclaimer:	N/A
[529]	限制： Limitation:	N/A
[527]	條件： Condition:	N/A
	其他： Others	N/A
[220]	提交日期： Date of Filing:	17-06-2021
[320]	聲稱具有優先權的日期： Date of Priority Claimed:	N/A
[310]	優先權申請編號： Priority Application Number:	N/A
[340]	聲稱具有優先權 (部分)： Priority Claim Details:	N/A
[330]	優先權申請的	N/A

國家、地區、地方：

Country, territory, area of
Priority Applications:

[210] 商標申請編號： 305751586
Application No.:

[540] 商標：
Mark:



majUP

[550] 商標種類： Ordinary
Mark Type:

一系列商標： NO
Series Mark:

[571] 商標描述： The applicant claims the colours blue, white
Mark Description: and turquoise as elements of the trade mark.

[730] 註冊申請人的姓名 / 名稱、地址： Majorel Berlin GmbH
Applicant(s) ' Wohlrabedamm 32
Name, Address: 13629 Berlin
GERMANY

[740/ 註冊申請人的送達地址： DEACONS
750] Applicant's Address for 5th Floor,
Service: Alexandra House Central
HONG KONG

[511] 類別編號： 9, 35, 36, 38, 39, 41, 42, 43, 45
Class(es) No(s) .:

[511] 貨品 / 服務說明： Class 45:
Specification: Legal services; Security services for the
physical protection of property; Legal license
management; Licensing of computer software
[legal services]; Licensing [legal services]
within the framework of software publishing;
Legal advice on participating in tenders;
Litigation services; Drafting legal documents
for others; Registration of domain names
[legal service]; Legal services in the field
of contract negotiation for others; Rental of
internet domain names; Legal research; Legal
inquiries; Establishing social contacts on the

Internet [social networking services]; Legal monitoring services.

[526] 卸棄: N/A
Disclaimer:
[529] 限制: N/A
Limitation:
[527] 條件: N/A
Condition:
其他: N/A
Others
[220] 提交日期: 20-09-2021
Date of Filing:
[320] 聲稱具有優先權的日期: 19-03-2021
Date of Priority Claimed:
[310] 優先權申請編號: 302021006047
Priority Application Number:
[340] 聲稱具有優先權 (部分): N/A
Priority Claim Details:
[330] 優先權申請的
國家、地區、地方: GERMANY
Country, territory, area of
Priority Applications:

[210] 商標申請編號: 305753368
Application No.:

[540] 商標:
Mark:

范家齊

[550] 商標種類: Ordinary
Mark Type:
一系列商標: NO
Series Mark:

[571] 商標描述: N/A
Mark Description:

[730] 註冊申請人的姓名 / 名稱、地址: K FANS UNION LIMITED (良朋友匯有限公司)
Applicant(s) ' FLAT/RM 1728, STAR HOUSE,
Name,Address: 3 SALISBURY ROAD, TSIM SHA TSUI, KL,
HONG KONG

[740/ 註冊申請人的送達地址: TMCR INTELLECTUAL PROPERTY LIMITED
750] Applicant's Address for Unit 2505, 25/F., Billion Plaza,
Service: 8 Cheung Yue Street, Cheung Sha Wan, Kowloon,
HONG KONG

- [511] 類別編號 : 35,45
Class(es) No(s) .:
- [511] 貨品 / 服務說明 :
Specification:
- Class 45:
Personal and social services rendered by others to meet the needs of individuals; fortune telling; fortune telling services provided via online website and the Internet; Feng Shui based fortune telling services; Suan ming (Chinese fortune telling) service; Feng Shui research; Zi wei dou shu (Chinese Astrology) fortune Telling; fortune-telling based on constellation data; Feng Shui appraisals services; fortune telling and forecasting within the domain of Fung Shui and principle of I Ching; divination, astrology, or provision of information thereof; I Ching divination, namely, divination services provided via using I Ching (ancient Chinese divination text); I Ching based Chinese fortune telling (Suan ming) services; Feng Shui, metaphysics service; provision of horoscopes; geomancy consultations (feng shui); residence, office Feng Shui geomancy layout consultations; personal naming services; personal naming services, namely, including selecting personal name and company name incorporating Feng Shui as well as I Ching divination; personal number selection, namely, including selecting telephone number, personalised number plates, house number, password, incorporating Feng Shui as well as I Ching divination; personal event date, residence or office location selection based on Feng Shui and I Ching based fortune telling; Suan ming (Chinese fortune telling) service for mate selection; fortune improvement and fortune improvement advisory on heterosexual relationship or on business; information and consultancy services relating to Feng Shui, astrology, metaphysics, I Ching divination and Zi wei dou shu fortune telling; all the aforesaid included in Class 45.
- [526] 卸棄 : N/A
Disclaimer:
- [529] 限制 : N/A
Limitation:
- [527] 條件 : N/A
Condition:
其他 : By consent, No. 305189626.
Others
- [220] 提交日期 : 23-09-2021
Date of Filing:
- [320] 聲稱具有優先權的日期 : N/A
Date of Priority Claimed:

[310] 優先權申請編號 : N/A
Priority Application Number:
[340] 聲稱具有優先權 (部分) : N/A
Priority Claim Details:
[330] 優先權申請的 N/A
國家、地區、地方 :
Country, territory, area of
Priority Applications:

[210] 商標申請編號 : 305753377
Application No.:

[540] 商標 :
Mark:

家齊易經

[550] 商標種類 : Ordinary
Mark Type:
一系列商標 : NO
Series Mark:

[571] 商標描述 : N/A
Mark Description:

[730] 註冊申請人的姓名 / 名稱、地址 : K FANS UNION LIMITED (良朋友匯有限公司)
Applicant(s) ' FLAT/RM 1728, STAR HOUSE,
Name, Address: 3 SALISBURY ROAD, TSIM SHA TSUI, KL,
HONG KONG

[740/ 註冊申請人的送達地址 : TMCR INTELLECTUAL PROPERTY LIMITED
750] Applicant's Address for Unit 2505, 25/F., Billion Plaza,
Service: 8 Cheung Yue Street, Cheung Sha Wan, Kowloon,
HONG KONG

[511] 類別編號 : 35, 45
Class(es) No(s) .:

[511] 貨品 / 服務說明 : Class 45:
Specification: Personal and social services rendered by
others to meet the needs of individuals;
fortune telling; fortune telling services
provided via online website and the Internet;
Feng Shui based fortune telling services; Suan
ming (Chinese fortune telling) service; Feng
Shui research; Zi wei dou shu (Chinese
Astrology) fortune Telling; fortune-telling
based on constellation data; Feng Shui
appraisals services; fortune telling and
forecasting within the domain of Fung Shui and
principle of I Ching; divination, astrology,
or provision of information thereof; I Ching
divination, namely, divination services
provided via using I Ching (ancient Chinese
divination text); I Ching based Chinese

fortune telling (Suan ming) services; Feng Shui, metaphysics service; provision of horoscopes; geomancy consultations (feng shui); residence, office Feng Shui geomancy layout consultations; personal naming services; personal naming services, namely, including selecting personal name and company name incorporating Feng Shui as well as I Ching divination; personal number selection, namely, including selecting telephone number, personalised number plates, house number, password, incorporating Feng Shui as well as I Ching divination; personal event date, residence or office location selection based on Feng Shui and I Ching based fortune telling; Suan ming (Chinese fortune telling) service for mate selection; fortune improvement and fortune improvement advisory on heterosexual relationship or on business; information and consultancy services relating to Feng Shui, astrology, metaphysics, I Ching divination and Zi wei dou shu fortune telling; all the aforesaid included in Class 45.

- [526] 卸棄 : N/A
Disclaimer:
- [529] 限制 : N/A
Limitation:
- [527] 條件 : N/A
Condition:
其他 : By consent, No. 305189626.
Others
- [220] 提交日期 : 23-09-2021
Date of Filing:
- [320] 聲稱具有優先權的日期 : N/A
Date of Priority Claimed:
- [310] 優先權申請編號 : N/A
Priority Application Number:
- [340] 聲稱具有優先權 (部分) : N/A
Priority Claim Details:
- [330] 優先權申請的
國家、地區、地方 : N/A
Country, territory, area of
Priority Applications:

-
- [210] 商標申請編號 : 305798189
Application No.:

[540] 商標 :	
Mark:	
[550] 商標種類 :	Ordinary
Mark Type:	
一系類商標 :	NO
Series Mark:	
[571] 商標描述 :	N/A
Mark Description:	
[730] 註冊申請人的姓名 / 名稱、地址 :	NortonLifeLock Inc.
Applicant(s) 'Name, Address:	60 E Rio Salado Parkway, Suite 1000, Tempe, Arizona 85281, UNITED STATES OF AMERICA
[740/ 註冊申請人的送達地址 :	WILKINSON & GRIST
750] Applicant's Address for Service:	6th Floor, Prince's Building Chater Road, Central HONG KONG
[511] 類別編號 :	9, 35, 36, 38, 42, 45
Class(es) No(s) .:	
[511] 貨品 / 服務說明 :	Class 45:
Specification:	Providing consultation and information in the field of identity theft protection featuring methods and techniques to safeguard computerized and online personal identifying information from unauthorized access.
[526] 卸棄 :	N/A
Disclaimer:	
[529] 限制 :	N/A
Limitation:	
[527] 條件 :	N/A
Condition:	
其他 :	N/A
Others	
[220] 提交日期 :	10-11-2021
Date of Filing:	
[320] 聲稱具有優先權的日期 :	N/A
Date of Priority Claimed:	
[310] 優先權申請編號 :	N/A
Priority Application Number:	
[340] 聲稱具有優先權 (部分) :	N/A
Priority Claim Details:	
[330] 優先權申請的	N/A
國家、地區、地方 :	
Country, territory, area of Priority Applications:	

[210] 商標申請編號 : 305806800
Application No.:

[540] 商標 :
Mark:



[550] 商標種類 : Ordinary
Mark Type:

一系列商標 : NO
Series Mark:

[571] 商標描述 : The applicant claims the color red as an
Mark Description: element of the trade mark.

[730] 註冊申請人的姓名 / 名稱、地址 : DIGITAL HEARTS HOLDINGS Co., Ltd.
Applicant(s) ' 3-20-2 NISHI-SHINJUKU,
Name,Address: SHINJUKU-KU, TOKYO,
JAPAN

[740/ 註冊申請人的送達地址 : CHINA PATENT AGENT (HONG KONG) LIMITED
750] Applicant's Address for 22/F, Great Eagle Centre,
Service: 23 Harbour Road, Wanchai,
HONG KONG

[511] 類別編號 : 35,45
Class(es) No(s) .:

[511] 貨品 / 服務說明 : Class 45:
Specification: Copyright licensing agency services, and
advisory, consultancy and information services
relating thereto; intellectual property agency
services for commercialization; intellectual
property management; legal information
services on utilization of intellectual
property; licensing of intellectual property,
and advisory, consultancy and information
services relating thereto; advisory,
consultancy and information services on
licensing of industrial property and
copyright; agency services for licensing of
industrial property and copyright; providing
information about intellectual property rights
via an on-line computer database; computer
software licensing, and advisory, consultancy
and information services relating thereto;
agencies for licensing of copyright relating
to sound, audio, music, still and moving
images; licensing [legal services] in the
framework of software publishing; game
character licensing, and advisory, consultancy

and information services relating thereto; licensing services relating to the manufacture of goods [legal services]; legal consultancy for working of industrial property; intellectual property consultancy; licensing of intellectual property; monitoring intellectual property rights, and advisory, consultancy and information services relating thereto; management and exploitation of industrial property rights and copyright by licensing for others [legal services]; leasing reproduction rights of photographs and transparencies to others [legal services]; management of copyright and neighbouring right; legal advisory, consultancy and information services relating import suspension and export suspension procedures; agencies for licensing of copyright relating to computer music; agencies for licensing of copyright relating to computer programs, and advisory, consultancy and information services relating thereto; agencies for licensing of copyright in the field of games, and advisory, consultancy and information services relating thereto; matchmaking services; online social networking services, and advisory, consultancy and information services relating thereto; information relating to fashion coordination services for individuals; information relating to fashion coordination services for individuals in the field of fashion using game character; security guarding for facilities; personal bodyguarding; monitoring and surveillance of security systems, and advisory, consultancy and information services relating thereto; investigation or surveillance on checking background profiles; information services (personal background investigations) on background profiles and personal history of celebrity, performer and entertainer; fortune-telling; non-therapeutic counselling services rendered to meet the needs of individuals; fortune-telling using game characters via Internet, and advisory, consultancy and information services relating thereto; clothing rental, and advisory, consultancy and information services relating thereto; rental of game character designed clothing, headwear or shoes, and advisory, consultancy and information services relating thereto; rental of fire alarms; rental of fire extinguishers; rental of security surveillance equipment, and advisory, consultancy and information services relating thereto; rental of personal ornaments for wearing, and advisory, consultancy and information services

relating thereto; rental of personal game character designed ornaments for wearing, and advisory, consultancy and information services relating thereto; leasing of internet domain names, and advisory, consultancy and information services relating thereto; legal research relating to business mergers, and advisory, consultancy and information services relating thereto; concierge services, and advisory, consultancy and information services relating thereto.

- [526] 卸棄 : N/A
Disclaimer:
- [529] 限制 : N/A
Limitation:
- [527] 條件 : N/A
Condition:
其他 : N/A
Others
- [220] 提交日期 : 19-11-2021
Date of Filing:
- [320] 聲稱具有優先權的日期 : 06-07-2021
Date of Priority Claimed:
- [310] 優先權申請編號 : 2021-084391
Priority Application Number:
- [340] 聲稱具有優先權 (部分) : N/A
Priority Claim Details:
- [330] 優先權申請的
國家、地區、地方 : JAPAN
Country, territory, area of
Priority Applications:
-
-

- [210] 商標申請編號 : 305806819
Application No.:

[540] 商標 :
Mark:



[550] 商標種類 : Ordinary
Mark Type:
一系列商標 : NO
Series Mark:

[571] 商標描述 : The applicant claims the color red as an
Mark Description: element of the trade mark.

[730] 註冊申請人的姓名 / 名稱、地址 : DIGITAL HEARTS HOLDINGS Co., Ltd.
Applicant(s) ' 3-20-2 NISHI-SHINJUKU,
Name,Address: SHINJUKU-KU, TOKYO,
JAPAN

[740/ 註冊申請人的送達地址 : CHINA PATENT AGENT (HONG KONG) LIMITED
750] Applicant's Address for 22/F, Great Eagle Centre,
Service: 23 Harbour Road, Wanchai,
HONG KONG

[511] 類別編號 : 35,45
Class(es) No(s) .:

[511] 貨品 / 服務說明 : Class 45:
Specification: Copyright licensing agency services, and
advisory, consultancy and information services
relating thereto; intellectual property agency
services for commercialization; intellectual
property management; legal information
services on utilization of intellectual
property; licensing of intellectual property,
and advisory, consultancy and information
services relating thereto; advisory,
consultancy and information services on
licensing of industrial property and
copyright; agency services for licensing of
industrial property and copyright; providing
information about intellectual property rights
via an on-line computer database; computer
software licensing, and advisory, consultancy
and information services relating thereto;
agencies for licensing of copyright relating
to sound, audio, music, still and moving
images; licensing [legal services] in the
framework of software publishing; game
character licensing, and advisory, consultancy

and information services relating thereto; licensing services relating to the manufacture of goods [legal services]; legal consultancy for working of industrial property; intellectual property consultancy; licensing of intellectual property; monitoring intellectual property rights, and advisory, consultancy and information services relating thereto; management and exploitation of industrial property rights and copyright by licensing for others [legal services]; leasing reproduction rights of photographs and transparencies to others [legal services]; management of copyright and neighbouring right; legal advisory, consultancy and information services relating import suspension and export suspension procedures; agencies for licensing of copyright relating to computer music; agencies for licensing of copyright relating to computer programs, and advisory, consultancy and information services relating thereto; agencies for licensing of copyright in the field of games, and advisory, consultancy and information services relating thereto; matchmaking services; online social networking services, and advisory, consultancy and information services relating thereto; information relating to fashion coordination services for individuals; information relating to fashion coordination services for individuals in the field of fashion using game character; security guarding for facilities; personal bodyguarding; monitoring and surveillance of security systems, and advisory, consultancy and information services relating thereto; investigation or surveillance on checking background profiles; information services (personal background investigations) on background profiles and personal history of celebrity, performer and entertainer; fortune-telling; non-therapeutic counselling services rendered to meet the needs of individuals; fortune-telling using game characters via Internet, and advisory, consultancy and information services relating thereto; clothing rental, and advisory, consultancy and information services relating thereto; rental of game character designed clothing, headwear or shoes, and advisory, consultancy and information services relating thereto; rental of fire alarms; rental of fire extinguishers; rental of security surveillance equipment, and advisory, consultancy and information services relating thereto; rental of personal ornaments for wearing, and advisory, consultancy and information services

relating thereto; rental of personal game character designed ornaments for wearing, and advisory, consultancy and information services relating thereto; leasing of internet domain names, and advisory, consultancy and information services relating thereto; legal research relating to business mergers, and advisory, consultancy and information services relating thereto; concierge services, and advisory, consultancy and information services relating thereto.

- [526] 卸棄 : N/A
Disclaimer:
- [529] 限制 : N/A
Limitation:
- [527] 條件 : N/A
Condition:
其他 : N/A
Others
- [220] 提交日期 : 19-11-2021
Date of Filing:
- [320] 聲稱具有優先權的日期 : 06-07-2021
Date of Priority Claimed:
- [310] 優先權申請編號 : 2021-084390
Priority Application Number:
- [340] 聲稱具有優先權 (部分) : N/A
Priority Claim Details:
- [330] 優先權申請的
國家、地區、地方 : JAPAN
Country, territory, area of
Priority Applications:

-
-
- [210] 商標申請編號 : 305806828
Application No.:

- [540] 商標 : A
Mark:

電心艾克斯

B

电心艾克斯

- [550] 商標種類 : Ordinary
Mark Type:
一系列商標 : YES
Series Mark:

- [571] 商標描述 : N/A
Mark Description:
- [730] 註冊申請人的姓名 / 名稱、地址 : DIGITAL HEARTS HOLDINGS Co., Ltd.
Applicant(s) ' 3-20-2 NISHI-SHINJUKU,
Name,Address: SHINJUKU-KU, TOKYO,
JAPAN
- [740/ 註冊申請人的送達地址 : CHINA PATENT AGENT (HONG KONG) LIMITED
750] Applicant's Address for 22/F, Great Eagle Centre,
Service: 23 Harbour Road, Wanchai,
HONG KONG
- [511] 類別編號 : 35,45
Class(es) No(s) .:
- [511] 貨品 / 服務說明 : Class 45:
Specification: Copyright licensing agency services, and
advisory, consultancy and information services
relating thereto; intellectual property agency
services for commercialization; intellectual
property management; legal information
services on utilization of intellectual
property; licensing of intellectual property,
and advisory, consultancy and information
services relating thereto; advisory,
consultancy and information services on
licensing of industrial property and
copyright; agency services for licensing of
industrial property and copyright; providing
information about intellectual property rights
via an on-line computer database; computer
software licensing, and advisory, consultancy
and information services relating thereto;
agencies for licensing of copyright relating
to sound, audio, music, still and moving
images; licensing [legal services] in the
framework of software publishing; game
character licensing, and advisory, consultancy
and information services relating thereto;
licensing services relating to the manufacture
of goods [legal services]; legal consultancy
for working of industrial property;
intellectual property consultancy; licensing
of intellectual property; monitoring
intellectual property rights, and advisory,
consultancy and information services relating
thereto; management and exploitation of
industrial property rights and copyright by
licensing for others [legal services]; leasing
reproduction rights of photographs and
transparencies to others [legal services];
management of copyright and neighbouring
right; legal advisory, consultancy and
information services relating import
suspension and export suspension procedures;
agencies for licensing of copyright relating
to computer music; agencies for licensing of
copyright relating to computer programs, and
advisory, consultancy and information services

relating thereto; agencies for licensing of copyright in the field of games, and advisory, consultancy and information services relating thereto; matchmaking services; online social networking services, and advisory, consultancy and information services relating thereto; information relating to fashion coordination services for individuals; information relating to fashion coordination services for individuals in the field of fashion using game character; security guarding for facilities; personal bodyguarding; monitoring and surveillance of security systems, and advisory, consultancy and information services relating thereto; investigation or surveillance on checking background profiles; information services (personal background investigations) on background profiles and personal history of celebrity, performer and entertainer; fortune-telling; non-therapeutic counselling services rendered to meet the needs of individuals; fortune-telling using game characters via Internet, and advisory, consultancy and information services relating thereto; clothing rental, and advisory, consultancy and information services relating thereto; rental of game character designed clothing, headwear or shoes, and advisory, consultancy and information services relating thereto; rental of fire alarms; rental of fire extinguishers; rental of security surveillance equipment, and advisory, consultancy and information services relating thereto; rental of personal ornaments for wearing, and advisory, consultancy and information services relating thereto; rental of personal game character designed ornaments for wearing, and advisory, consultancy and information services relating thereto; leasing of internet domain names, and advisory, consultancy and information services relating thereto; legal research relating to business mergers, and advisory, consultancy and information services relating thereto; concierge services, and advisory, consultancy and information services relating thereto.

- [526] 卸棄 : N/A
Disclaimer:
- [529] 限制 : N/A
Limitation:
- [527] 條件 : N/A
Condition:
- 其他 : N/A
Others

[220] 提交日期 : 19-11-2021
Date of Filing:

[320] 聲稱具有優先權的日期 : N/A
Date of Priority Claimed:

[310] 優先權申請編號 : N/A
Priority Application Number:

[340] 聲稱具有優先權 (部分) : N/A
Priority Claim Details:

[330] 優先權申請的
國家、地區、地方 : N/A
Country, territory, area of
Priority Applications:

[210] 商標申請編號 : 305806837
Application No.:

[540] 商標 :
Mark:

DIGITAL HEARTS CROSS

[550] 商標種類 : Ordinary
Mark Type:
一系列商標 : NO
Series Mark:

[571] 商標描述 : N/A
Mark Description:

[730] 註冊申請人的姓名 / 名稱、地址 : DIGITAL HEARTS HOLDINGS Co., Ltd.
Applicant(s) ' 3-20-2 NISHI-SHINJUKU,
Name, Address: SHINJUKU-KU, TOKYO,
JAPAN

[740/ 註冊申請人的送達地址 : CHINA PATENT AGENT (HONG KONG) LIMITED
750] Applicant's Address for 22/F, Great Eagle Centre,
Service: 23 Harbour Road, Wanchai,
HONG KONG

[511] 類別編號 : 35,45
Class(es) No(s) .:

[511] 貨品 / 服務說明 : Class 45:
Specification: Copyright licensing agency services, and
advisory, consultancy and information services
relating thereto; intellectual property agency
services for commercialization; intellectual
property management; legal information
services on utilization of intellectual
property; licensing of intellectual property,
and advisory, consultancy and information
services relating thereto; advisory,
consultancy and information services on
licensing of industrial property and
copyright; agency services for licensing of

industrial property and copyright; providing information about intellectual property rights via an on-line computer database; computer software licensing, and advisory, consultancy and information services relating thereto; agencies for licensing of copyright relating to sound, audio, music, still and moving images; licensing [legal services] in the framework of software publishing; game character licensing, and advisory, consultancy and information services relating thereto; licensing services relating to the manufacture of goods [legal services]; legal consultancy for working of industrial property; intellectual property consultancy; licensing of intellectual property; monitoring intellectual property rights, and advisory, consultancy and information services relating thereto; management and exploitation of industrial property rights and copyright by licensing for others [legal services]; leasing reproduction rights of photographs and transparencies to others [legal services]; management of copyright and neighbouring right; legal advisory, consultancy and information services relating import suspension and export suspension procedures; agencies for licensing of copyright relating to computer music; agencies for licensing of copyright relating to computer programs, and advisory, consultancy and information services relating thereto; agencies for licensing of copyright in the field of games, and advisory, consultancy and information services relating thereto; matchmaking services; online social networking services, and advisory, consultancy and information services relating thereto; information relating to fashion coordination services for individuals; information relating to fashion coordination services for individuals in the field of fashion using game character; security guarding for facilities; personal bodyguarding; monitoring and surveillance of security systems, and advisory, consultancy and information services relating thereto; investigation or surveillance on checking background profiles; information services (personal background investigations) on background profiles and personal history of celebrity, performer and entertainer; fortune-telling; non-therapeutic counselling services rendered to meet the needs of individuals; fortune-telling using game characters via Internet, and advisory, consultancy and information services relating thereto; clothing rental, and advisory,

consultancy and information services relating thereto; rental of game character designed clothing, headwear or shoes, and advisory, consultancy and information services relating thereto; rental of fire alarms; rental of fire extinguishers; rental of security surveillance equipment, and advisory, consultancy and information services relating thereto; rental of personal ornaments for wearing, and advisory, consultancy and information services relating thereto; rental of personal game character designed ornaments for wearing, and advisory, consultancy and information services relating thereto; leasing of internet domain names, and advisory, consultancy and information services relating thereto; legal research relating to business mergers, and advisory, consultancy and information services relating thereto; concierge services, and advisory, consultancy and information services relating thereto.

- [526] 卸棄 : N/A
Disclaimer:
- [529] 限制 : N/A
Limitation:
- [527] 條件 : N/A
Condition:
其他 : N/A
Others
- [220] 提交日期 : 19-11-2021
Date of Filing:
- [320] 聲稱具有優先權的日期 : 21-05-2021
Date of Priority Claimed:
- [310] 優先權申請編號 : 2021-062237
Priority Application Number:
- [340] 聲稱具有優先權 (部分) : N/A
Priority Claim Details:
- [330] 優先權申請的 JAPAN
國家、地區、地方 :
Country, territory, area of
Priority Applications:
-
-

- [210] 商標申請編號 : 305822055
Application No.:

[540] 商標 :	
Mark:	ComEasy 管理易
[550] 商標種類 :	Ordinary
Mark Type:	
一系列商標 :	NO
Series Mark:	
[571] 商標描述 :	N/A
Mark Description:	
[730] 註冊申請人的姓名 / 名稱、地址 :	Perfect Event Services Limited
Applicant(s) ' Name, Address:	Unit 1, 7/F, Kai Fuk Industrial Centre, 1 Wang Tung Street, Kowloon Bay, Kowloon HONG KONG
[740/ 註冊申請人的送達地址 :	Ng Wing Chun / FSE Engineering Group Limited
750] Applicant's Address for Service:	Units 801-810, Chevalier Commercial Centre, No.8 Wang Hoi Road, Kowloon Bay, Kowloon HONG KONG
[511] 類別編號 :	9, 35, 36, 38, 42, 45
Class(es) No(s) .:	
[511] 貨品 / 服務說明 :	Class 45:
Specification:	Guards and security patrol services; security services for the protection of property; guarding of buildings; housekeeping services (security services); computerised security and surveillance services for business establishments; monitoring and reporting services relating to security and surveillance systems.
[526] 卸棄 :	N/A
Disclaimer:	
[529] 限制 :	N/A
Limitation:	
[527] 條件 :	N/A
Condition:	
其他 :	N/A
Others	
[220] 提交日期 :	06-12-2021
Date of Filing:	
[320] 聲稱具有優先權的日期 :	N/A
Date of Priority Claimed:	
[310] 優先權申請編號 :	N/A
Priority Application Number:	
[340] 聲稱具有優先權 (部分) :	N/A
Priority Claim Details:	
[330] 優先權申請的 國家、地區、地方 :	N/A

Country, territory, area of
Priority Applications:

[210] 商標申請編號 : 305833530
Application No.:

[540] 商標 :
Mark: **PERIDOT**

[550] 商標種類 : Ordinary
Mark Type:
一系列商標 : NO
Series Mark:

[571] 商標描述 : N/A
Mark Description:

[730] 註冊申請人的姓名 / 名稱、地址 : Niantic, Inc.
Applicant(s) ' 1 Ferry Building, Suite 200,
Name, Address: San Francisco, California 94111,
UNITED STATES OF AMERICA

[740/ 註冊申請人的送達地址 : Rouse & Co. International (Overseas) Limited
750] Applicant's Address for 26/F., Tesbury Centre,
Service: 28 Queen's Road East
HONG KONG

[511] 類別編號 : 9, 41, 42, 45
Class(es) No(s) .:

[511] 貨品 / 服務說明 : Class 45:
Specification: Online social networking services.

[526] 卸棄 : N/A
Disclaimer:

[529] 限制 : N/A
Limitation:

[527] 條件 : N/A
Condition:
其他 : N/A
Others

[220] 提交日期 : 16-12-2021
Date of Filing:

[320] 聲稱具有優先權的日期 : 29-06-2021
Date of Priority Claimed:

[310] 優先權申請編號 : 083656
Priority Application Number:

[340] 聲稱具有優先權 (部分) : N/A
Priority Claim Details:

[330] 優先權申請的 JAMAICA
國家、地區、地方 :

Country, territory, area of
Priority Applications:

- [210] 商標申請編號 : 305838157
Application No.:
- [540] 商標 : A
Mark: 
- B

- [550] 商標種類 : Ordinary
Mark Type:
一系列商標 : YES
Series Mark:
- [571] 商標描述 : N/A
Mark Description:
- [730] 註冊申請人的姓名 / 名稱、地址 : Hong Kong Science and Technology Parks Corporation
Applicant(s) ' Name,Address: 5/F, Building 5E, 5 Science Park East Avenue, Hong Kong Science Park, HONG KONG
- [740/ 註冊申請人的送達地址 : DEACONS
750] Applicant's Address for Service: 5th Floor, Alexandra House Central HONG KONG
- [511] 類別編號 : 35,36,39,41,45
Class(es) No(s) .:
- [511] 貨品 / 服務說明 : Class 45:
Specification: Legal services; licensing of intellectual property; licensing of technology; licensing of computer software; acquisition of intellectual property; incubation of intellectual property assets (intellectual property services); advisory services relating to regulatory affairs; immigration consultancy services for corporations and individuals; provision of information in relation to migration and immigration; arranging visa preparation and applications other than travel visas; mentoring [personal or spiritual]; charitable services, namely organising and conducting volunteer programmes and community service projects (being social services rendered by others to meet the needs of individuals); social networking services; online social networking services; personal and social services rendered by others to meet the needs of individuals; providing information relating to diverse human

cultures, beliefs, and lifestyles; provision of social and community services to meet needs of individuals; provision of information relating to services as specified above for club members via the Internet, databases or other electronic means; social introduction agencies; information, consultancy, and advisory services relating to the aforesaid services; all included in Class 45.

[526]	卸棄： Disclaimer:	N/A
[529]	限制： Limitation:	N/A
[527]	條件： Condition: 其他： Others	N/A
[220]	提交日期： Date of Filing:	21-12-2021
[320]	聲稱具有優先權的日期： Date of Priority Claimed:	N/A
[310]	優先權申請編號： Priority Application Number:	N/A
[340]	聲稱具有優先權 (部分)： Priority Claim Details:	N/A
[330]	優先權申請的 國家、地區、地方： Country, territory, area of Priority Applications:	N/A

[210]	商標申請編號： Application No.:	305838166
[540]	商標： Mark:	A



HKSTP  **創科快線**

B

HKSTP  **创科快线**

[550]	商標種類： Mark Type:	Ordinary
	一系列商標： Series Mark:	YES
[571]	商標描述： Mark Description:	N/A

- [730] 註冊申請人的姓名 / 名稱、地址 :
Applicant(s)'
Name,Address: Hong Kong Science and Technology Parks Corporation
5/F, Building 5E, 5 Science Park East Avenue,
Hong Kong Science Park,
HONG KONG
- [740/ 註冊申請人的送達地址 :
750] Applicant's Address for
Service: DEACONS
5th Floor,
Alexandra House Central
HONG KONG
- [511] 類別編號 :
Class(es) No(s) .: 35,36,39,41,45
- [511] 貨品 / 服務說明 :
Specification: Class 45:
Legal services; licensing of intellectual property; licensing of technology; licensing of computer software; acquisition of intellectual property; incubation of intellectual property assets (intellectual property services); advisory services relating to regulatory affairs; immigration consultancy services for corporations and individuals; provision of information in relation to migration and immigration; arranging visa preparation and applications other than travel visas; mentoring [personal or spiritual]; charitable services, namely organising and conducting volunteer programmes and community service projects (being social services rendered by others to meet the needs of individuals); social networking services; online social networking services; personal and social services rendered by others to meet the needs of individuals; providing information relating to diverse human cultures, beliefs, and lifestyles; provision of social and community services to meet needs of individuals; provision of information relating to services as specified above for club members via the Internet, databases or other electronic means; social introduction agencies; information, consultancy, and advisory services relating to the aforesaid services; all included in Class 45.
- [526] 卸棄 :
Disclaimer: N/A
- [529] 限制 :
Limitation: N/A
- [527] 條件 :
Condition: N/A
- 其他 :
Others N/A
- [220] 提交日期 :
Date of Filing: 21-12-2021
- [320] 聲稱具有優先權的日期 :
Date of Priority Claimed: N/A

[310]	優先權申請編號 : Priority Application Number:	N/A
[340]	聲稱具有優先權 (部分) : Priority Claim Details:	N/A
[330]	優先權申請的 國家、地區、地方 : Country, territory, area of Priority Applications:	N/A
<hr/>		
[210]	商標申請編號 : Application No.:	305838175
[540]	商標 : Mark:	A 
		B 
[550]	商標種類 : Mark Type:	Ordinary
	一系列商標 : Series Mark:	YES
[571]	商標描述 : Mark Description:	N/A
[730]	註冊申請人的姓名 / 名稱、地址 : Applicant(s)' Name, Address:	Hong Kong Science and Technology Parks Corporation 5/F, Building 5E, 5 Science Park East Avenue, Hong Kong Science Park, HONG KONG
[740/750]	註冊申請人的送達地址 : Applicant's Address for Service:	DEACONS 5th Floor, Alexandra House Central HONG KONG
[511]	類別編號 : Class(es) No(s) .:	35, 36, 39, 41, 45
[511]	貨品 / 服務說明 : Specification:	Class 45: Legal services; licensing of intellectual property; licensing of technology; licensing of computer software; acquisition of intellectual property; incubation of intellectual property assets (intellectual property services); advisory services relating to regulatory affairs; immigration consultancy services for corporations and individuals; provision of information in relation to migration and immigration; arranging visa preparation and applications other than travel visas; mentoring [personal or spiritual]; charitable services, namely organising and conducting volunteer programmes and community

service projects (being social services rendered by others to meet the needs of individuals); social networking services; online social networking services; personal and social services rendered by others to meet the needs of individuals; providing information relating to diverse human cultures, beliefs, and lifestyles; provision of social and community services to meet needs of individuals; provision of information relating to services as specified above for club members via the Internet, databases or other electronic means; social introduction agencies; information, consultancy, and advisory services relating to the aforesaid services; all included in Class 45.

- [526] 卸棄 : N/A
Disclaimer:
- [529] 限制 : N/A
Limitation:
- [527] 條件 : N/A
Condition:
其他 : N/A
Others
- [220] 提交日期 : 21-12-2021
Date of Filing:
- [320] 聲稱具有優先權的日期 : N/A
Date of Priority Claimed:
- [310] 優先權申請編號 : N/A
Priority Application Number:
- [340] 聲稱具有優先權 (部分) : N/A
Priority Claim Details:
- [330] 優先權申請的 : N/A
國家、地區、地方 :
Country, territory, area of
Priority Applications:
-
-

- [210] 商標申請編號 : 305848020
Application No.:

[540] 商標：
Mark:



[550] 商標種類： 一般商標
Mark Type:
一系列商標： 否
Series Mark:
[571] 商標描述： 不適用
Mark Description:
[730] 註冊申請人的姓名 / 名稱、地址： 深圳市前海手繪科技文化有限公司
Applicant(s) ' 中國
Name, Address: 深圳市前海深港合作區
南山街道興海大道 3040 號前海世茂金融中心二期 1 棟 3607
[740/ 註冊申請人的送達地址： BORSAM INTELLECTUAL PROPERTY LIMITED
750] Applicant's Address for 香港
Service: 九龍旺角花園街 75-77 號
花園商業大廈 6 樓 605 室
[511] 類別編號： 9, 38, 41, 42, 45
Class(es) No(s) .:
[511] 貨品 / 服務說明： 類別 45:
Specification: 夜間護衛服務；安全及防盜警報系統的監控；工廠安全檢查；
社交陪伴；社交護送（陪伴）；臨時看管房子；交友服務；在
線社交網絡服務；個人服裝搭配諮詢；計算機軟件許可（法律
服務）
[526] 卸棄： 不適用
Disclaimer:
[529] 限制： 不適用
Limitation:
[527] 條件： 不適用
Condition:
其他： 不適用
Others
[220] 提交日期： 31-12-2021
Date of Filing:
[320] 聲稱具有優先權的日期： 不適用
Date of Priority Claimed:
[310] 優先權申請編號： 不適用
Priority Application Number:

[340] 聲稱具有優先權 (部分): 不適用
Priority Claim Details:

[330] 優先權申請的 不適用
國家、地區、地方:
Country, territory, area of
Priority Applications:

[210] 商標申請編號: 305850720
Application No.:

[540] 商標: A
Mark:



B



[550] 商標種類: 一般商標
Mark Type:
一系列商標: 是
Series Mark:

[571] 商標描述: 不適用
Mark Description:

[730] 註冊申請人的姓名 / 名稱、地址: Quwan (HK) Limited
Applicant(s) ' 香港
Name, Address: 軒尼詩道 245-251 號

[740/ 註冊申請人的送達地址: 萬慧達 (亞太) 諮詢有限公司

750] Applicant's Address for 香港
Service: 灣仔港灣道 18 號
中環廣場 1903 室

[511] 類別編號: 9, 45
Class(es) No(s) .:

[511] 貨品 / 服務說明: 類別 45:
Specification: 安全及防盜警報系統的監控; 社交陪伴; 計算機交友服務; 交友服務; 服裝出租; 追蹤被盜財產; 法律研究; 互聯網域名租賃; 在線社交網絡服務; 計算機軟件許可。

[526] 卸棄: 不適用
Disclaimer:

[529] 限制: 不適用
Limitation:

[527] 條件: 不適用
Condition:
其他: 不適用
Others

[220] 提交日期: 05-01-2022
Date of Filing:

[320] 聲稱具有優先權的日期: 不適用
Date of Priority Claimed:

[310] 優先權申請編號: 不適用
Priority Application Number:

[340] 聲稱具有優先權 (部分): 不適用
Priority Claim Details:

[330] 優先權申請的
國家、地區、地方: 不適用
Country, territory, area of
Priority Applications:

[210] 商標申請編號: 305852548
Application No.:

[540] 商標:
Mark:

Akashic Healing



[550] 商標種類: 一般商標
Mark Type:

一系列商標: 否

Series Mark:

[571] 商標描述: 不適用
Mark Description:

[730] 註冊申請人的姓名 / 名稱、地址:
Applicant(s) ' Name, Address:

TAI SHUK YI

香港

黃竹坑業勤街 33-35 號

金來工業大廈 2 期 18 樓 E 室

[740/ 註冊申請人的送達地址:

戴淑儀

750] Applicant's Address for
Service:

香港

黃竹坑業興街 11 號

南匯廣場 B 座 6 樓 607-608 室

[511] 類別編號:

16, 41, 45

Class(es) No(s) .:

[511] 貨品 / 服務說明 : Specification:	類別 45: 宗教服務 ; 由他人提供的為滿足個人心理和精神需要的心靈諮詢服務。
[526] 卸棄 : Disclaimer:	不適用
[529] 限制 : Limitation:	不適用
[527] 條件 : Condition: 其他 : Others	不適用
[220] 提交日期 : Date of Filing:	07-01-2022
[320] 聲稱具有優先權的日期 : Date of Priority Claimed:	不適用
[310] 優先權申請編號 : Priority Application Number:	不適用
[340] 聲稱具有優先權 (部分) : Priority Claim Details:	不適用
[330] 優先權申請的 國家、地區、地方 : Country, territory, area of Priority Applications:	不適用

[210] 商標申請編號 : 305855013
Application No.:

[540] 商標 :
Mark:



[550] 商標種類 : Ordinary
Mark Type:
一系列商標 : NO
Series Mark:

[571] 商標描述 : The applicant claims the colours Pantone 3258C and Pantone Cool Gray 8C as elements of the trade mark.
Mark Description:

[730] 註冊申請人的姓名 / 名稱、地址 : SOCAM Development Limited
Applicant (s) ' 34th Floor, Shui On Centre
Name, Address: 6-8 Harbour Road
HONG KONG

[740/ 註冊申請人的送達地址 : Mr. Wilson Lam / Ms. Cindia Au
750] Applicant's Address for 13th Floor, New Kowloon Plaza
Service: 38 Tai Kok Tsui Road, Kowloon
HONG KONG

[511] 類別編號 : 36,37,45
Class(es) No(s) .:

[511] 貨品 / 服務說明 : Class 45:
Specification: Security services, security guard services;
security administration for houses and
buildings; security consultancy services;
security assessment services; events security
services; provision of information, advisory
and consultancy services relating to all the
aforesaid services.

[526] 卸棄 : N/A
Disclaimer:

[529] 限制 : N/A
Limitation:

[527] 條件 : N/A
Condition:
其他 : N/A
Others

[220] 提交日期 : 11-01-2022
Date of Filing:

[320] 聲稱具有優先權的日期 : N/A
Date of Priority Claimed:

[310] 優先權申請編號 : N/A
Priority Application Number:

[340] 聲稱具有優先權 (部分) : N/A
Priority Claim Details:

[330] 優先權申請的 N/A
國家、地區、地方 :
Country, territory, area of
Priority Applications:

[210] 商標申請編號 : 305856913
Application No.:

[540] 商標 :
Mark:

A



B



[550] 商標種類 : Ordinary
 Mark Type:
 一系列商標 : YES
 Series Mark:
 [571] 商標描述 : N/A
 Mark Description:
 [730] 註冊申請人的姓名 / 名稱、地址 : Lemon Inc.
 Applicant(s) ' P.O. Box 31119 Grand Pavilion, Hibiscus Way,
 Name,Address: 802 West Bay Road, Grand Cayman, KY1 - 1205,
 CAYMAN ISLANDS
 [740/ 註冊申請人的送達地址 : Rouse & Co. International (Overseas) Limited
 750] Applicant's Address for 26/F., Tesbury Centre,
 Service: 28 Queen's Road East
 HONG KONG
 [511] 類別編號 : 9,35,38,41,42,45
 Class(es) No(s) .:
 [511] 貨品 / 服務說明 : Class 45:
 Specification: Licensing of intellectual property; management
 of intellectual property; licensing services
 relating to music publishing; online social
 networking services; information, advisory and

consultancy services relating to all the aforesaid.

- [526] 卸棄 : N/A
Disclaimer:
- [529] 限制 : N/A
Limitation:
- [527] 條件 : N/A
Condition:
其他 : N/A
Others
- [220] 提交日期 : 12-01-2022
Date of Filing:
- [320] 聲稱具有優先權的日期 : N/A
Date of Priority Claimed:
- [310] 優先權申請編號 : N/A
Priority Application Number:
- [340] 聲稱具有優先權 (部分) : N/A
Priority Claim Details:
- [330] 優先權申請的
國家、地區、地方 : N/A
Country, territory, area of
Priority Applications:

-
- [210] 商標申請編號 : 305858876
Application No.:

- [540] 商標 :
Mark:

WHEELS UP

- [550] 商標種類 : Ordinary
Mark Type:
一系列商標 : NO
Series Mark:
- [571] 商標描述 : N/A
Mark Description:
- [730] 註冊申請人的姓名/名稱、地址 :
Applicant(s) ' Name, Address:
Wheels Up Partners LLC
601 West 26th Street Suite 900
New York, New York 10001
UNITED STATES OF AMERICA
- [740/ 註冊申請人的送達地址 :
750] Applicant's Address for
Service:
CHINA PATENT AGENT (HONG KONG) LIMITED
22/F, Great Eagle Centre,
23 Harbour Road, Wanchai,
HONG KONG
- [511] 類別編號 : 9, 25, 35, 39, 42, 43, 45
Class(es) No(s) .:

[730] 註冊申請人的姓名 / 名稱、地址 : Hong Kong Breast Cancer Foundation Limited
Applicant(s)' Name, Address: 22/F, Jupiter Tower
9 Jupiter Street, North Point
HONG KONG

[740/ 註冊申請人的送達地址 : Pansy Leung Tang & Chua Solicitors
750] Applicant's Address for 21/F, Regent Centre,
Service: No.88 Queen's Road Central
HONG KONG

[511] 類別編號 : 16,36,41,42,44,45
Class(es) No(s) .:

[511] 貨品 / 服務說明 : Class 45:
Specification: Personal and social services rendered by
others to meet the needs of individuals;
security services for the protection of
property and individuals; legal services.

[526] 卸棄 : N/A
Disclaimer:

[529] 限制 : N/A
Limitation:

[527] 條件 : N/A
Condition:
其他 : N/A
Others

[220] 提交日期 : 17-01-2022
Date of Filing:

[320] 聲稱具有優先權的日期 : N/A
Date of Priority Claimed:

[310] 優先權申請編號 : N/A
Priority Application Number:

[340] 聲稱具有優先權 (部分) : N/A
Priority Claim Details:

[330] 優先權申請的 N/A
國家、地區、地方 :
Country, territory, area of
Priority Applications:

[210] 商標申請編號 : 305861214
Application No.:

[540] 商標 :
Mark:



[550] 商標種類 : 一般商標
Mark Type:
一系列商標 : 否
Series Mark:

[571] 商標描述 : 不適用
Mark Description:

[730] 註冊申請人的姓名 / 名稱、地址 : Hong Kong Intellectual Property Exchange, Ltd.
Applicant(s) ' Level 17, Silvercord Tower 2,
Name, Address: 30 Canton Road, Tsim Sha Tsui, Kowloon
HONG KONG

[740/ 註冊申請人的送達地址 : HKIPX
750] Applicant's Address for Level 17, Silvercord Tower 2,
Service: 30 Canton Road, Tsim Sha Tsui, Kowloon,
HONG KONG

[511] 類別編號 : 41, 45
Class(es) No(s) .:

[511] 貨品 / 服務說明 : 類別 45:
Specification: 知識產權諮詢; 知識產權許可; 專利許可諮詢; 版權許可諮詢
; 版權管理諮詢; 知識產權代理服務; 商標代理服務; 有關知
識產權的顧問服務; 專利許可申請 (法律服務); 已註冊的外觀
設計的許可 (法律服務); 為法律諮詢目的監控知識產權; 有關
經營的專業法律諮詢; 版權管理; 訴訟服務

[526] 卸棄 : 不適用
Disclaimer:

[529] 限制 : 不適用
Limitation:

[527] 條件 : 不適用
Condition:
其他 : 不適用
Others

[220] 提交日期 : 18-01-2022
Date of Filing:

[320] 聲稱具有優先權的日期 : 不適用
Date of Priority Claimed:

[310] 優先權申請編號 : 不適用
Priority Application Number:

[340] 聲稱具有優先權 (部分): 不適用

Priority Claim Details:

[330] 優先權申請的 不適用

國家、地區、地方:

Country, territory, area of
Priority Applications:
