

# 香港知識產權公報

Hong Kong Intellectual Property Journal

2019 年 10 月 11 日

11 October 2019

## 目錄

### Contents

#### 根據註冊外觀設計條例第 25 條註冊的外觀設計

#### **Designs Registered under section 25 of the Registered Designs Ordinance**

按註冊編號排列

Arranged by Registration Number

#### 根據註冊外觀設計條例(第 522 章)公布的其他公告

#### **Other Notices Published under the Registered Designs Ordinance (Cap. 522)**

根據註冊外觀設計條例第 28 條, 註冊外觀設計因未繳續期費而停止有效

Registered designs ceased through non-payment of renewal fees under section 28 of the Registered Designs Ordinance

根據註冊外觀設計規則第 31 條刪除的註冊外觀設計

Registered designs removed under section 31 of the Registered Designs Rules

#### 以下事項沒有記錄

#### **No Records for the Following Matters**

根據註冊外觀設計條例第 30 條放棄的外觀設計的註冊

Surrender of Registration of Design under section 30 of the Registered Designs Ordinance

根據註冊外觀設計規則第 37 條, 向處長作出轉介

Reference to Registrar under section 37 of the Registered Designs Rules

根據註冊外觀設計條例第 45 條, 撤銷註冊

Revocation of Registration under section 45 of the Registered Designs Ordinance

根據註冊外觀設計規則第 46 條，向法院作出轉介  
Reference to Court under section 46 of the Registered Designs Rules

根據註冊外觀設計規則第 63 條對不符合規定之處作出糾正  
Rectification of Irregularities under section 63 of the Registered Designs Rules

根據註冊外觀設計條例第 66 條，糾正註冊紀錄冊  
Rectification of Register under section 66 of the Registered Designs Ordinance

根據註冊外觀設計條例第 67 條，更正註冊紀錄冊內的錯誤  
Correction of Errors in Register under section 67 of the Registered Designs Ordinance

根據註冊外觀設計條例第 67 及 76 條，更正註冊紀錄冊內及已提交文件中的錯誤  
Correction of Errors in Register and in Filed Documents under sections  
67 and 76 of the Registered Designs Ordinance

根據註冊外觀設計條例第 76 條，更正已提交文件中的錯誤  
Correction of Errors in Filed Documents under section 76 of the Registered Designs  
Ordinance

勘誤  
Corrigendum

## 註冊外觀設計公告註釋

### Notes on advertisements of registration of designs

方括號表示下列資料：

Square brackets indicate the following data：

- [11] 註冊編號 Registration number / 聯合王國註冊編號 United Kingdom registration number
  
- [15] 註冊日期 Registration date / 當作註冊日期 Deemed registration date / 聯合王國註冊日期 United Kingdom registration date
  
- [17] 註冊有效期屆滿日期 Expiry date of the period of registration
  
- [22] 提交日期 Filing date / 當作提交日期 Deemed filing date / 聯合王國提交日期 United Kingdom filing date
  
- [30] 聲稱享有的優先權 ( 提交日期 / 巴黎公約國或世界貿易組織成員 / 申請編號 ) Priority claimed (filing date / Paris Convention country or WTO member / application number)
  
- [51] 國際外觀設計分類號 ( 洛迦諾分類號 ) International Classification of designs (Locarno Classification)
  
- [54] 物品 Article
  
- [55] 外觀設計的表述 Representation of the design
  
- [62] 分開前的申請編號及提交日期 Application number before division and filing date
  
- [66] 過往註冊的聯繫外觀設計註冊編號 / 日期 Registration No. / Date of Previous Registration for Association
  
- [72] 設計人 Designer

[73] 擁有人姓名和地址 Name and address of the owner

[74] 代理人 Agent / 送達地址 Address for service



香港特別行政區政府知識產權署外觀設計註冊處

The Government of the Hong Kong Special Administrative Region

Designs Registry, Intellectual Property Department

## 根據註冊外觀設計條例第 25 條註冊的外觀設計

### Designs registered under section 25 of the Registered Designs Ordinance

按註冊編號排列

Arranged by Registration Number

[11] 1801928.9

[15] 20-09-2018

[51] Cl. 14-01

[54] 便攜式立體聲藍牙音箱

Portable stereo bluetooth speaker

[73] BOOMPODS (HK) LTD.

ROOM 303-304, HANKOW CENTRE,

5-15 HANKOW RD., T.S.T.,

KOWLOON, HONG KONG

[74] BOOMPODS (HK) LTD.

ROOM 303-304, HANKOW CENTRE,

5-15 HANKOW ROAD, T.S.T.,

KOWLOON, HONG KONG



---

[11] 1802288.1M001

[15] 23-11-2018

[30] 25-05-2018 / FR / 2018-2479

[51] Cl. 26-04

[54] 蠟燭

Candle

[73] LOUIS VUITTON MALLETTIER

2, rue du Pont-Neuf 75001 Paris,

FRANCE

[74] BAKER & MCKENZIE

14th Floor, One Taikoo Place

979 King's Road, Quarry Bay  
HONG KONG



---

[11] 1802288.1M002

[15] 23-11-2018

[30] 25-05-2018 / FR / 2018-2479

[51] Cl. 26-04

[54] 蠟燭

Candle

[73] LOUIS VUITTON MALLETIER

2, rue du Pont-Neuf 75001 Paris,

FRANCE

[74] BAKER & MCKENZIE

14th Floor, One Taikoo Place

979 King's Road, Quarry Bay

HONG KONG



[11] 1802288.1M003

[15] 23-11-2018

[30] 25-05-2018 / FR / 2018-2468

[51] Cl. 26-04

[54] 帶蓋的蠟燭

Candle with lid

[73] LOUIS VUITTON MALLETIER

2, rue du Pont-Neuf 75001 Paris,  
FRANCE

[74] BAKER & MCKENZIE

14th Floor, One Taikoo Place  
979 King's Road, Quarry Bay  
HONG KONG



---

[11] 1802288.1M004

[15] 23-11-2018

[30] 25-05-2018 / FR / 2018-2468-002

[51] Cl. 26-04

[54] 帶蓋的蠟燭

Candle with lid

[73] LOUIS VUITTON MALLETIER

2, rue du Pont-Neuf 75001 Paris,  
FRANCE

[74] BAKER & MCKENZIE

14th Floor, One Taikoo Place  
979 King's Road, Quarry Bay  
HONG KONG





---

[11] 1900128.2M001

[15] 21-01-2019

[30] 17-12-2018 / JP / 027448 of 2018

[51] Cl. 9-01

[54] 噴霧器

Spray container

[73] 久光製藥株式會社

HISAMITSU PHARMACEUTICAL CO., INC.

408, Tashirodaikan-machi,

Tosu-shi, Saga 841-0017,

JAPAN

[74] Wilkinson & Grist

6th Floor, Prince's Building,

Chater Road,

Hong Kong.



---

[11] 1900128.2M002

[15] 21-01-2019

[30] 20-12-2018 / JP / 027864 of 2018

[51] Cl. 9-01

[54] 噴霧器

Spray container

[73] 久光製藥株式會社

HISAMITSU PHARMACEUTICAL CO., INC.  
408, Tashirodaikan-machi,  
Tosu-shi, Saga 841-0017,  
JAPAN

[74] Wilkinson & Grist

6th Floor, Prince's Building,  
Chater Road,  
Hong Kong.



---

[11] 1900128.2M003

[15] 21-01-2019

[30] 20-12-2018 / JP / 027864 of 2018

[51] Cl. 9-01

[54] 噴霧器

Spray container

[73] 久光製藥株式會社

HISAMITSU PHARMACEUTICAL CO., INC.  
408, Tashirodaikan-machi,  
Tosu-shi, Saga 841-0017,  
JAPAN

[74] Wilkinson & Grist

6th Floor, Prince's Building,  
Chater Road,  
Hong Kong.



---

[11] 1900128.2M004

[15] 21-01-2019

[30] 20-12-2018 / JP / 027865 of 2018

[51] Cl. 9-03

[54] 包裝盒

Packing box

[73] 久光製藥株式會社

HISAMITSU PHARMACEUTICAL CO., INC.  
408, Tashirodaikan-machi,  
Tosu-shi, Saga 841-0017,  
JAPAN

[74] Wilkinson & Grist

6th Floor, Prince's Building,  
Chater Road,  
Hong Kong.



---

[11] 1900128.2M005

[15] 21-01-2019

[30] 20-12-2018 / JP / 027865 of 2018

[51] Cl. 9-03

[54] 包裝盒

Packing box

[73] 久光製藥株式會社

HISAMITSU PHARMACEUTICAL CO., INC.  
408, Tashirodaikan-machi,  
Tosu-shi, Saga 841-0017,  
JAPAN

[74] Wilkinson & Grist

6th Floor, Prince's Building,  
Chater Road,  
Hong Kong.



---

[11] 1900128.2M006

[15] 21-01-2019

[30] 20-12-2018 / JP / 027867 of 2018

[51] Cl. 9-03

[54] 包裝盒

Packing box

[73] 久光製藥株式會社

HISAMITSU PHARMACEUTICAL CO., INC.  
408, Tashirodaikan-machi,  
Tosu-shi, Saga 841-0017,  
JAPAN

[74] Wilkinson & Grist

6th Floor, Prince's Building,  
Chater Road,  
Hong Kong.

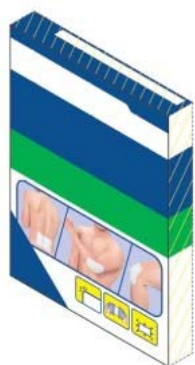

---

[11] 1900128.2M007

[15] 21-01-2019

[30] 20-12-2018 / JP / 027867 of 2018

[51] Cl. 9-03

[54] 包裝盒

Packing box

[73] 久光製藥株式會社

HISAMITSU PHARMACEUTICAL CO., INC.

408, Tashirodaikan-machi,

Tosu-shi, Saga 841-0017,

JAPAN

[74] Wilkinson & Grist

6th Floor, Prince's Building,

Chater Road,

Hong Kong.



---

[11] 1900128.2M008

[15] 21-01-2019

[30] 17-12-2018 / JP / 027466 of 2018

[51] Cl. 9-03

[54] 包裝盒

Packing box

[73] 久光製藥株式會社

HISAMITSU PHARMACEUTICAL CO., INC.  
408, Tashirodaikan-machi,  
Tosu-shi, Saga 841-0017,  
JAPAN

[74] Wilkinson & Grist

6th Floor, Prince's Building,  
Chater Road,  
Hong Kong.



---

[11] 1900128.2M009

[15] 21-01-2019

[30] 17-12-2018 / JP / 027466 of 2018

[51] Cl. 9-03

[54] 包裝盒

Packing box

[73] 久光製藥株式會社

HISAMITSU PHARMACEUTICAL CO., INC.  
408, Tashirodaikan-machi,  
Tosu-shi, Saga 841-0017,  
JAPAN

[74] Wilkinson & Grist

6th Floor, Prince's Building,  
Chater Road,  
Hong Kong.



---

[11] 1900128.2M010

[15] 21-01-2019

[30] 23-07-2018 / JP / 016058 of 2018

[51] Cl. 9-03

[54] 包裝盒

Packing box

[73] 久光製藥株式會社

HISAMITSU PHARMACEUTICAL CO., INC.  
408, Tashirodaikan-machi,  
Tosu-shi, Saga 841-0017,  
JAPAN

[74] Wilkinson & Grist

6th Floor, Prince's Building,  
Chater Road,  
Hong Kong.

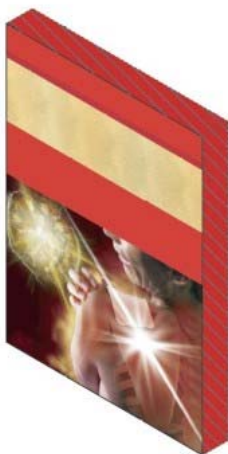

---

[11] 1900128.2M011

- [15] 21-01-2019
- [30] 23-07-2018 / JP / 016058 of 2018
- [51] Cl. 9-03
- [54] 包裝盒  
Packing box
- [73] 久光製藥株式會社  
HISAMITSU PHARMACEUTICAL CO., INC.  
408, Tashirodaikan-machi,  
Tosu-shi, Saga 841-0017,  
JAPAN
- [74] Wilkinson & Grist  
6th Floor, Prince's Building,  
Chater Road,  
Hong Kong.



- 
- [11] 1900128.2M012
- [15] 21-01-2019
- [30] 23-07-2018 / JP / 016059 of 2018
- [51] Cl. 9-03
- [54] 包裝盒  
Packing box
- [73] 久光製藥株式會社  
HISAMITSU PHARMACEUTICAL CO., INC.  
408, Tashirodaikan-machi,  
Tosu-shi, Saga 841-0017,  
JAPAN
- [74] Wilkinson & Grist  
6th Floor, Prince's Building,  
Chater Road,  
Hong Kong.





[11] 1900128.2M013

[15] 21-01-2019

[30] 23-07-2018 / JP / 016059 of 2018

[51] Cl. 9-03

[54] 包裝盒

Packing box

[73] 久光製藥株式會社

HISAMITSU PHARMACEUTICAL CO., INC.  
408, Tashirodaikan-machi,  
Tosu-shi, Saga 841-0017,  
JAPAN

[74] Wilkinson & Grist

6th Floor, Prince's Building,  
Chater Road,  
Hong Kong.



[11] 1900128.2M014

[15] 21-01-2019

[30] 17-12-2018 / JP / 027467 of 2018

[51] Cl. 9-03

[54] 包裝盒

Packing box

[73] 久光製藥株式會社

HISAMITSU PHARMACEUTICAL CO., INC.

408, Tashirodaikan-machi,

Tosu-shi, Saga 841-0017,

JAPAN

[74] Wilkinson & Grist

6th Floor, Prince's Building,

Chater Road,

Hong Kong.

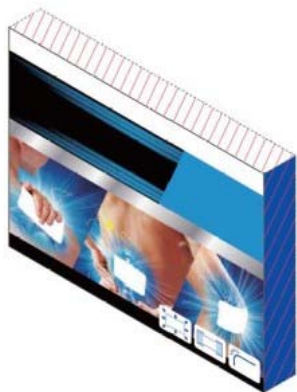

---

[11] 1900128.2M015

[15] 21-01-2019

[30] 17-12-2018 / JP / 027467 of 2018

[51] Cl. 9-03

[54] 包裝盒

Packing box

[73] 久光製藥株式會社

HISAMITSU PHARMACEUTICAL CO., INC.

408, Tashirodaikan-machi,

Tosu-shi, Saga 841-0017,

JAPAN

[74] Wilkinson & Grist

6th Floor, Prince's Building,

Chater Road,

Hong Kong.



---

[11] 1900128.2M016

[15] 21-01-2019

[30] 17-12-2018 / JP / 027468 of 2018

[51] Cl. 9-03

[54] 包裝盒

Packing box

[73] 久光製藥株式會社

HISAMITSU PHARMACEUTICAL CO., INC.  
408, Tashirodaikan-machi,  
Tosu-shi, Saga 841-0017,  
JAPAN

[74] Wilkinson & Grist

6th Floor, Prince's Building,  
Chater Road,  
Hong Kong.



---

[11] 1900128.2M017

- [15] 21-01-2019
- [30] 17-12-2018 / JP / 027468 of 2018
- [51] Cl. 9-03
- [54] 包裝盒  
Packing box
- [73] 久光製藥株式會社  
HISAMITSU PHARMACEUTICAL CO., INC.  
408, Tashirodaikan-machi,  
Tosu-shi, Saga 841-0017,  
JAPAN
- [74] Wilkinson & Grist  
6th Floor, Prince's Building,  
Chater Road,  
Hong Kong.



- 
- [11] 1900140.7M001
- [15] 22-01-2019
- [51] Cl. 14-04
- [54] 螢幕顯示與圖像的圖形符號和標誌、表面圖案、裝飾  
Graphic symbols and logos, surface patterns, ornamentation for  
screen display and icons
- [73] Top Ease Asia Investment Limited  
18/F, East Town Building,  
41 Lockhart Road,  
Wan Chai, Hong Kong
- [74] Top Ease Asia Investment Limited  
18/F, East Town Building,  
41 Lockhart Road,  
Wan Chai, Hong Kong



---

[11] 1900140.7M002

[15] 22-01-2019

[51] Cl. 14-04

[54] 螢幕顯示與圖像的圖形符號和標誌、表面圖案、裝飾

Graphic symbols and logos, surface patterns, ornamentation for screen display and icons

[73] Top Ease Asia Investment Limited

18/F, East Town Building,  
41 Lockhart Road,  
Wan Chai, Hong Kong

[74] Top Ease Asia Investment Limited

18/F, East Town Building,  
41 Lockhart Road,  
Wan Chai, Hong Kong



---

[11] 1900140.7M003

[15] 22-01-2019

[51] Cl. 14-04

[54] 螢幕顯示與圖像的圖形符號和標誌、表面圖案、裝飾

Graphic symbols and logos, surface patterns, ornamentation for screen display and icons

[73] Top Ease Asia Investment Limited

18/F, East Town Building,  
41 Lockhart Road,  
Wan Chai, Hong Kong

[74] Top Ease Asia Investment Limited

18/F, East Town Building,  
41 Lockhart Road,  
Wan Chai, Hong Kong



---

[11] 1900141.9M001

[15] 22-01-2019

[51] Cl. 2-02

[54] 服裝的圖形符號和標誌、表面圖案、裝飾

Graphic symbols and logos, surface patterns, ornamentation for garments

[73] Top Ease Asia Investment Limited

18/F, East Town Building,  
41 Lockhart Road,  
Wan Chai, Hong Kong

[74] Top Ease Asia Investment Limited

18/F, East Town Building,  
41 Lockhart Road,  
Wan Chai, Hong Kong



---

[11] 1900141.9M002

[15] 22-01-2019

[51] Cl. 2-02

[54] 服裝的圖形符號和標誌、表面圖案、裝飾

Graphic symbols and logos, surface patterns, ornamentation for garments

[73] Top Ease Asia Investment Limited

18/F, East Town Building,

41 Lockhart Road,

Wan Chai, Hong Kong

[74] Top Ease Asia Investment Limited

18/F, East Town Building,

41 Lockhart Road,

Wan Chai, Hong Kong



---

[11] 1900141.9M003

[15] 22-01-2019

[51] Cl. 2-02

- [54] 服裝的圖形符號和標誌、表面圖案、裝飾  
Graphic symbols and logos, surface patterns, ornamentation for garments
- [73] Top Ease Asia Investment Limited  
18/F, East Town Building,  
41 Lockhart Road,  
Wan Chai, Hong Kong
- [74] Top Ease Asia Investment Limited  
18/F, East Town Building,  
41 Lockhart Road,  
Wan Chai, Hong Kong



- 
- [11] 1900149.6M001
- [15] 23-01-2019
- [51] Cl. 13-03
- [54] 旋轉編碼開關蓋子  
Rotary dip switch cover
- [73] 艾斯艾姆開關有限公司  
SM SWITCH CO., LTD.  
大韓民國首爾市 九老  
區京仁路 53 街 15  
GA-3502
- [74] 香港商標 & 設計代理有限公司  
六國中心 6 樓  
灣仔告士打道 72 號  
HONG KONG  
HONG KONG





---

[11] 1900149.6M002

[15] 23-01-2019

[51] Cl. 13-03

[54] 旋轉編碼開關蓋子

Rotary dip switch cover

[73] 艾斯艾姆開關有限公司

SM SWITCH CO., LTD.

大韓民國首爾市 九老

區京仁路 53 街 15

GA-3502

[74] 香港商標 & 設計代理有限公司

六國中心 6 樓

灣仔告士打道 72 號

HONG KONG

HONG KONG



---

[11] 1900149.6M003

[15] 23-01-2019

[51] Cl. 13-03

[54] 迷你旋轉編碼開關蓋子  
Mini rotary dip switch cover

[73] 艾斯艾姆開關有限公司  
SM SWITCH CO., LTD.  
大韓民國首爾市 九老  
區京仁路 53 街 15  
GA-3502

[74] 香港商標 & 設計代理有限公司  
六國中心 6 樓  
灣仔告士打道 72 號  
HONG KONG  
HONG KONG



---

[11] 1900149.6M004

[15] 23-01-2019

[51] Cl. 13-03

[54] 迷你旋轉編碼開關蓋子  
Mini rotary dip switch cover

[73] 艾斯艾姆開關有限公司  
SM SWITCH CO., LTD.  
大韓民國首爾市 九老  
區京仁路 53 街 15  
GA-3502

[74] 香港商標 & 設計代理有限公司  
六國中心 6 樓  
灣仔告士打道 72 號  
HONG KONG  
HONG KONG



---

[11] 1900187.6M001

[15] 29-01-2019

[30] 03-08-2018 / FR / 2018-3647

[51] Cl. 3-01

[54] 行李箱

Luggage

[73] LOUIS VUITTON MALLETIER

2 rue du Pont-Neuf,

75001 Paris,

FRANCE

[74] SIT FUNG KWONG & SHUM

9th Floor, York House, The Landmark,

15 Queen's Road Central,

Hong Kong.



---

[11] 1900187.6M002

[15] 29-01-2019

[30] 03-08-2018 / FR / 2018-3647

[51] Cl. 3-01

[54] 行李箱

Luggage

[73] LOUIS VUITTON MALLETIER

2 rue du Pont-Neuf,  
75001 Paris,  
FRANCE

[74] SIT FUNG KWONG & SHUM

9th Floor, York House, The Landmark,  
15 Queen's Road Central,  
Hong Kong.



---

[11] 1900198.9M001

[15] 30-01-2019

[30] 10-01-2019 / US / 29/676,397

[51] Cl. 4-02

[54] 牙刷

Toothbrush

[73] World Wide Daily Holdings Company Limited

19/F., Koon Wah Mirror Factory 3rd Industrial Building,  
5-9 Ka Hing Road, Kwai Chung,  
New Territories, Hong Kong

[74] MARKS & CLERK

Level 9, Cyberport 1,  
100 Cyberport Road,  
Pok Fu Lam, Hong Kong.



---

[11] 1900198.9M002

[15] 30-01-2019

[30] 10-01-2019 / US / 29/676,397

[51] Cl. 4-02

[54] 牙刷

Toothbrush

[73] World Wide Daily Holdings Company Limited  
19/F., Koon Wah Mirror Factory 3rd Industrial Building,  
5-9 Ka Hing Road, Kwai Chung,  
New Territories, Hong Kong

[74] MARKS & CLERK  
Level 9, Cyberport 1,  
100 Cyberport Road,  
Pok Fu Lam, Hong Kong.



[11] 1900198.9M003

[15] 30-01-2019

[30] 10-01-2019 / US / 29/676,397

[51] Cl. 4-02

[54] 牙刷

Toothbrush

[73] World Wide Daily Holdings Company Limited

19/F., Koon Wah Mirror Factory 3rd Industrial Building,

5-9 Ka Hing Road, Kwai Chung,

New Territories, Hong Kong

[74] MARKS & CLERK

Level 9, Cyberport 1,

100 Cyberport Road,

Pok Fu Lam, Hong Kong.



---

[11] 1900198.9M004

[15] 30-01-2019

[30] 10-01-2019 / US / 29/676,397

[51] Cl. 4-02

[54] 牙刷

Toothbrush

[73] World Wide Daily Holdings Company Limited

19/F., Koon Wah Mirror Factory 3rd Industrial Building,

5-9 Ka Hing Road, Kwai Chung,

New Territories, Hong Kong

[74] MARKS & CLERK

Level 9, Cyberport 1,

100 Cyberport Road,

Pok Fu Lam, Hong Kong.



---

[11] 1900198.9M005

[15] 30-01-2019

[30] 10-01-2019 / US / 29/676,389

[51] Cl. 4-02

[54] 牙刷

Toothbrush

[73] World Wide Daily Holdings Company Limited  
19/F., Koon Wah Mirror Factory 3rd Industrial Building,  
5-9 Ka Hing Road, Kwai Chung,  
New Territories, Hong Kong

[74] MARKS & CLERK  
Level 9, Cyberport 1,  
100 Cyberport Road,  
Pok Fu Lam, Hong Kong.



[11] 1900198.9M006

[15] 30-01-2019

[30] 10-01-2019 / US / 29/676,389

[51] Cl. 4-02

[54] 牙刷

Toothbrush

[73] World Wide Daily Holdings Company Limited  
19/F., Koon Wah Mirror Factory 3rd Industrial Building,  
5-9 Ka Hing Road, Kwai Chung,  
New Territories, Hong Kong

[74] MARKS & CLERK  
Level 9, Cyberport 1,  
100 Cyberport Road,  
Pok Fu Lam, Hong Kong.



---

[11] 1900198.9M007

[15] 30-01-2019

[30] 10-01-2019 / US / 29/676,389

[51] Cl. 4-02

[54] 牙刷

Toothbrush

[73] World Wide Daily Holdings Company Limited  
19/F., Koon Wah Mirror Factory 3rd Industrial Building,  
5-9 Ka Hing Road, Kwai Chung,  
New Territories, Hong Kong

[74] MARKS & CLERK  
Level 9, Cyberport 1,  
100 Cyberport Road,  
Pok Fu Lam, Hong Kong.





---

[11] 1900198.9M008

[15] 30-01-2019

[30] 10-01-2019 / US / 29/676,389

[51] Cl. 4-02

[54] 牙刷

Toothbrush

[73] World Wide Daily Holdings Company Limited  
19/F., Koon Wah Mirror Factory 3rd Industrial Building,  
5-9 Ka Hing Road, Kwai Chung,  
New Territories, Hong Kong

[74] MARKS & CLERK  
Level 9, Cyberport 1,  
100 Cyberport Road,  
Pok Fu Lam, Hong Kong.

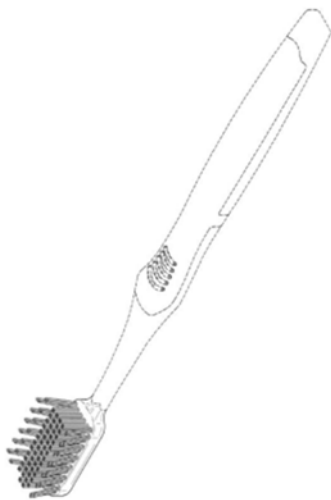

[11] 1900244.7M001

[15] 01-02-2019

[30] 21-11-2018 / US / 29/671,060

[51] Cl. 6-07

[54] 化妝鏡

Vanity mirror

[73] Erik A. Kaiser

19 Balbrook Drive Mendham,

NJ 07945,

UNITED STATES

[74] CHINAHONGKONG IP LIMITED

3011, 30/F, Office Tower,

Convention Plaza, 1 Harbour Road,

Hong Kong.



---

[11] 1900244.7M002

[15] 01-02-2019

[30] 21-11-2018 / US / 29/671,060

[51] Cl. 6-07

[54] 化妝鏡

Vanity mirror

[73] Erik A. Kaiser

19 Balbrook Drive Mendham,

NJ 07945,

UNITED STATES

[74] CHINAHONGKONG IP LIMITED

3011, 30/F, Office Tower,

Convention Plaza, 1 Harbour Road,

Hong Kong.



---

[11] 1900248.6M001

[15] 01-02-2019

[51] Cl. 9-03

[54] 一個容器

A Container

[73] Cross The Pacific Limited

3/F Bonham Centre,

79-85 Bonham Strand, Sheung Wan

Hong Kong

[74] Letters& Thoo Limited

Suite 1008, Prosperity Millennia Plaza,

663 King's Road, Quarry Bay

Hong Kong

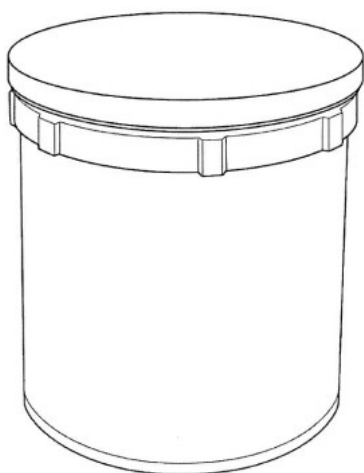

---

[11] 1900248.6M002

[15] 01-02-2019

[51] Cl. 9-03

[54] 一個容器

A Container

[73] Cross The Pacific Limited

3/F Bonham Centre,

79-85 Bonham Strand, Sheung Wan

Hong Kong

[74] Letters& Thoo Limited

Suite 1008, Prosperity Millennia Plaza,

663 King's Road, Quarry Bay

Hong Kong

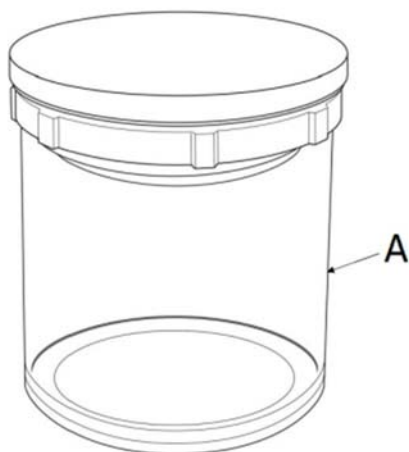

---

[11] 1900248.6M003

[15] 01-02-2019

[51] Cl. 9-03

[54] 一個容器

A Container

[73] Cross The Pacific Limited

3/F Bonham Centre,

79-85 Bonham Strand, Sheung Wan

Hong Kong

[74] Letters& Thoo Limited

Suite 1008, Prosperity Millennia Plaza,

663 King's Road, Quarry Bay

Hong Kong



---

[11] 1913549.0

[15] 29-04-2019

[51] Cl. 4-02

[54] 化妝用刷毛材料

Brush bristles material for makeup

[73] 株式會社黛怡茜

TAIKI CORP., LTD.

2-16, Miyakojimakitadori 1-Chome

Miyakojima-ku, Osaka-Shi, OSAKA, 534-0014, Japan

[74] UNITALEN ATTORNEYS AT LAW LIMITED

RM 1201, 12/F,

GOLDEN ERA PLAZA,

39-55 SAI YEE ST, MONGKOK KLN

HONG KONG

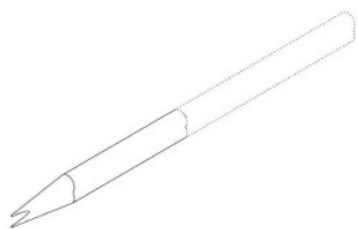

---

[11] 1913552.6

[15] 29-04-2019

[30] 29-11-2018 / CN / 201830684436.6

[51] Cl. 9-03

[54] 盒

Box

[73] Suntory Holdings Limited  
2-1-40 Dojimahama  
Kita-ku Osaka City, Osaka  
JAPAN

[74] MARKS & CLERK  
Level 9, Cyberport 1  
100 Cyberport Road, Pok Fu Lam  
HONG KONG



---

[11] 1913553.8

[15] 29-04-2019

[30] 02-11-2018 / EU / 005816105-0001

[51] Cl. 4-02

[54] 髮刷

Hair brush

[73] RICHARD WARD COUTURE STYLING LIMITED  
47 Marylebone Lane, London W1U 2NT, United Kingdom.

[74] VINCENT LUK & ASSOCIATES  
Unit A, 13,n Floor, Nathan Commercial Building,  
430 Nathan Road, Kowloon, Hong Kong.



---

[11] 1913554.0

[15] 29-04-2019

[30] 04-11-2018 / US / 29/668,983

[51] Cl. 7-06

[54] 粟米柄

Corn holder

[73] Helen of Troy Limited

The Phoenix Centre

George Street, Belleville, St. Michael

BARBADOS

[74] BIRD & BIRD

4/F Three Pacific Place

1 Queen's Road East

HONG KONG

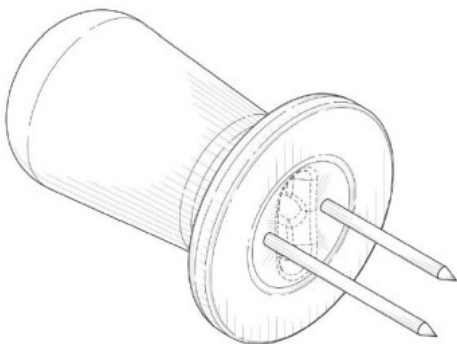

---

[11] 1913555.3

[15] 29-04-2019

[30] 05-11-2018 / US / 29/ 669,020

[51] Cl. 7-02

[54] 叉子連蓋

Fork and Cover

[73] Helen of Troy Limited

The Phoenix Centre

George Street, Belleville, St. Michael

BARBADOS

[74] BIRD & BIRD

4/F Three Pacific Place

1 Queen's Road East

HONG KONG

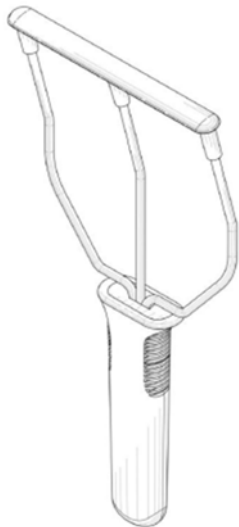

---

[11] 1913556.5M001

[15] 30-04-2019

[51] Cl. 3-01

[54] 行李箱

Luggage

[73] 新秀麗 IP 控股有限責任公司

Samsonite IP Holdings S.à r.l.

13-15 avenue de la Liberté

L-1931 Luxembourg

LUXEMBOURG

[74] WILKINSON & GRIST

6th Floor, Prince's Building

Chater Road

HONG KONG



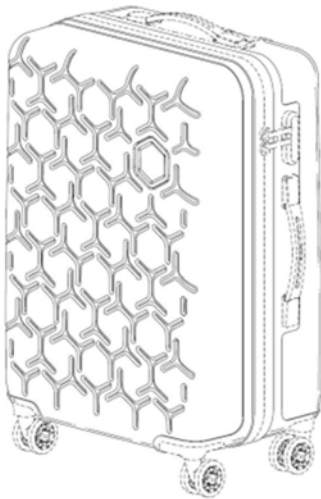

---

[11] 1913556.5M002

[15] 30-04-2019

[51] Cl. 3-01

[54] 行李箱

Luggage

[73] 新秀麗 IP 控股有限責任公司

Samsonite IP Holdings S.à r.l.

13-15 avenue de la Liberté

L-1931 Luxembourg

LUXEMBOURG

[74] WILKINSON & GRIST

6th Floor, Prince's Building

Chater Road

HONG KONG

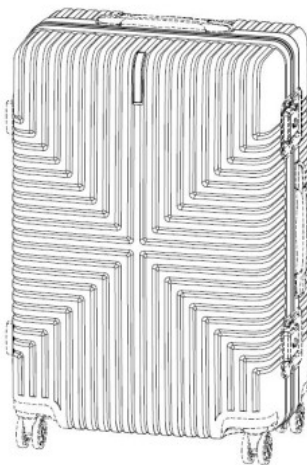

[11] 1913559.1

[15] 30-04-2019

[51] Cl. 2-07

[54] 拉鏈

Zipper

[73] 宜興市德林服飾科技有限公司

Yixing Delin Garments Technology Co., Ltd.

中國內地 江蘇省宜興市張渚鎮(犢山村)

北環路南側犢山路西側

[74] 標準香港企業註冊服務有限公司

香港

香港九龍旺角彌敦道 678 號 華僑商

業中心 15C



---

[11] 1913561.5M001

[15] 30-04-2019

[30] 31-10-2018 / EU / 005813292

[51] Cl. 2-04

[54] 鞋底

Shoe soles

[73] TOD'S S.p.A.

VIA FILIPPO DELLA VALLE 1,

I-63811 SANT'ELPIDIO A MARE (FERMO)

ITALY

[74] CHINA PATENT AGENT (HONG KONG) LIMITED

22/F, Great Eagle Centre, 23 Harbour Road, Wanchai

HONG KONG



---

[11] 1913561.5M002

[15] 30-04-2019

[30] 31-10-2018 / EU / 005813292

[51] Cl. 2-04

[54] 鞋底

Shoe soles

[73] TOD'S S.p.A.

VIA FILIPPO DELLA VALLE 1,  
I-63811 SANT'ELPIDIO A MARE (FERMO)  
ITALY

[74] CHINA PATENT AGENT (HONG KONG) LIMITED

22/F, Great Eagle Centre, 23 Harbour Road, Wanchai  
HONG KONG



---

[11] 1913562.7

[15] 30-04-2019

[30] 02-11-2018 / US / 29/668,851

[51] Cl. 24-02

[54] 玻片承載架

Slide rack carrier

[73] HOLOGIC, INC.

250 Campus Drive

Marlborough, Massachusetts 01752

UNITED STATES

[74] BARRON & YOUNG INTELLECTUAL PROPERTY LIMITED

Suite 617, Lakeside 2

No. 10 Science Park West Avenue, Hong Kong Science Park,  
Shatin, N.T.

HONG KONG

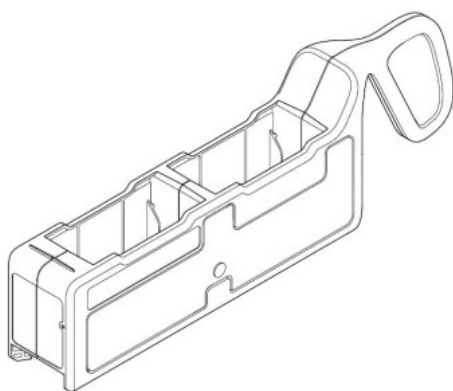

---

[11] 1913571.6M001

[15] 02-05-2019

[51] Cl. 11-01

[54] 飾物設計

Ornament design

[73] 六福集團有限公司

Luk Fook Holdings Company Limited

Floor 15, 20, 25 & 27, Metropole Square,

No.2 On Yiu Street, Shatin, New Territories,

HONG KONG

[74] Luk Fook Holdings Company Limited

(Legal Affairs Department)

Floor 25, Metropole Square

No.2 On Yiu Street, Shatin, New Territories,

HONG KONG



---

[11] 1913571.6M002

[15] 02-05-2019

[51] Cl. 11-01

[54] 飾物設計

Ornament design

[73] 六福集團有限公司

Luk Fook Holdings Company Limited  
Floor 15, 20, 25 & 27, Metropole Square,  
No.2 On Yiu Street, Shatin, New Territories,  
HONG KONG

[74] Luk Fook Holdings Company Limited

(Legal Affairs Department)

Floor 25, Metropole Square

No.2 On Yiu Street, Shatin, New Territories,  
HONG KONG



---

[11] 1913571.6M003

[15] 02-05-2019

[51] Cl. 11-01

[54] 飾物設計

Ornament design

[73] 六福集團有限公司

Luk Fook Holdings Company Limited  
Floor 15, 20, 25 & 27, Metropole Square,  
No.2 On Yiu Street, Shatin, New Territories,  
HONG KONG

[74] Luk Fook Holdings Company Limited

(Legal Affairs Department)  
Floor 25, Metropole Square  
No.2 On Yiu Street, Shatin, New Territories,  
HONG KONG



---

[11] 1913571.6M004

[15] 02-05-2019

[51] Cl. 11-01

[54] 飾物設計

Ornament design

[73] 六福集團有限公司

Luk Fook Holdings Company Limited  
Floor 15, 20, 25 & 27, Metropole Square,  
No.2 On Yiu Street, Shatin, New Territories,  
HONG KONG

[74] Luk Fook Holdings Company Limited

(Legal Affairs Department)  
Floor 25, Metropole Square  
No.2 On Yiu Street, Shatin, New Territories,  
HONG KONG



---

[11] 1913571.6M005

[15] 02-05-2019

[51] Cl. 11-01

[54] 飾物設計

Ornament design

[73] 六福集團有限公司

Luk Fook Holdings Company Limited  
Floor 15, 20, 25 & 27, Metropole Square,  
No.2 On Yiu Street, Shatin, New Territories,  
HONG KONG

[74] Luk Fook Holdings Company Limited

(Legal Affairs Department)  
Floor 25, Metropole Square  
No.2 On Yiu Street, Shatin, New Territories,  
HONG KONG



[11] 1913571.6M006

[15] 02-05-2019

[51] Cl. 11-01

[54] 飾物設計

Ornament design

[73] 六福集團有限公司

Luk Fook Holdings Company Limited  
Floor 15, 20, 25 & 27, Metropole Square,  
No.2 On Yiu Street, Shatin, New Territories,  
HONG KONG

[74] Luk Fook Holdings Company Limited

(Legal Affairs Department)

Floor 25, Metropole Square  
No.2 On Yiu Street, Shatin, New Territories,  
HONG KONG



---

[11] 1913571.6M007

[15] 02-05-2019

[51] Cl. 11-01

[54] 飾物設計

Ornament design

[73] 六福集團有限公司

Luk Fook Holdings Company Limited  
Floor 15, 20, 25 & 27, Metropole Square,  
No.2 On Yiu Street, Shatin, New Territories,  
HONG KONG

[74] Luk Fook Holdings Company Limited

(Legal Affairs Department)

Floor 25, Metropole Square  
No.2 On Yiu Street, Shatin, New Territories,  
HONG KONG





---

[11] 1913571.6M008

[15] 02-05-2019

[51] Cl. 11-01

[54] 飾物設計

Ornament design

[73] 六福集團有限公司

Luk Fook Holdings Company Limited  
Floor 15, 20, 25 & 27, Metropole Square,  
No.2 On Yiu Street, Shatin, New Territories,  
HONG KONG

[74] Luk Fook Holdings Company Limited

(Legal Affairs Department)

Floor 25, Metropole Square

No.2 On Yiu Street, Shatin, New Territories,  
HONG KONG



---

[11] 1913571.6M009

[15] 02-05-2019

[51] Cl. 11-01

[54] 飾物設計

Ornament design

[73] 六福集團有限公司

Luk Fook Holdings Company Limited  
Floor 15, 20, 25 & 27, Metropole Square,  
No.2 On Yiu Street, Shatin, New Territories,  
HONG KONG

[74] Luk Fook Holdings Company Limited

(Legal Affairs Department)

Floor 25, Metropole Square  
No.2 On Yiu Street, Shatin, New Territories,  
HONG KONG



---

[11] 1913571.6M010

[15] 02-05-2019

[51] Cl. 11-01

[54] 飾物設計

Ornament design

[73] 六福集團有限公司

Luk Fook Holdings Company Limited  
Floor 15, 20, 25 & 27, Metropole Square,  
No.2 On Yiu Street, Shatin, New Territories,  
HONG KONG

[74] Luk Fook Holdings Company Limited

(Legal Affairs Department)

Floor 25, Metropole Square  
No.2 On Yiu Street, Shatin, New Territories,  
HONG KONG



---

[11] 1913571.6M011

[15] 02-05-2019

[51] Cl. 11-01

[54] 飾物設計

Ornament design

[73] 六福集團有限公司

Luk Fook Holdings Company Limited  
Floor 15, 20, 25 & 27, Metropole Square,  
No.2 On Yiu Street, Shatin, New Territories,  
HONG KONG

[74] Luk Fook Holdings Company Limited

(Legal Affairs Department)  
Floor 25, Metropole Square  
No.2 On Yiu Street, Shatin, New Territories,  
HONG KONG



[11] 1913571.6M012

[15] 02-05-2019

[51] Cl. 11-01

[54] 飾物設計

Ornament design

[73] 六福集團有限公司

Luk Fook Holdings Company Limited  
Floor 15, 20, 25 & 27, Metropole Square,  
No.2 On Yiu Street, Shatin, New Territories,  
HONG KONG

[74] Luk Fook Holdings Company Limited

(Legal Affairs Department)

Floor 25, Metropole Square  
No.2 On Yiu Street, Shatin, New Territories,  
HONG KONG



---

[11] 1913571.6M013

[15] 02-05-2019

[51] Cl. 11-01

[54] 飾物設計

Ornament design

[73] 六福集團有限公司

Luk Fook Holdings Company Limited  
Floor 15, 20, 25 & 27, Metropole Square,  
No.2 On Yiu Street, Shatin, New Territories,  
HONG KONG

[74] Luk Fook Holdings Company Limited

(Legal Affairs Department)

Floor 25, Metropole Square

No.2 On Yiu Street, Shatin, New Territories,  
HONG KONG



---

[11] 1913571.6M014

[15] 02-05-2019

[51] Cl. 11-01

[54] 飾物設計

Ornament design

[73] 六福集團有限公司

Luk Fook Holdings Company Limited

Floor 15, 20, 25 & 27, Metropole Square,

No.2 On Yiu Street, Shatin, New Territories,

HONG KONG

[74] Luk Fook Holdings Company Limited

(Legal Affairs Department)

Floor 25, Metropole Square

No.2 On Yiu Street, Shatin, New Territories,

HONG KONG



---

[11] 1913571.6M015

[15] 02-05-2019

[51] Cl. 11-01

[54] 飾物設計

Ornament design

[73] 六福集團有限公司

Luk Fook Holdings Company Limited

Floor 15, 20, 25 & 27, Metropole Square,

No.2 On Yiu Street, Shatin, New Territories,  
HONG KONG

[74] Luk Fook Holdings Company Limited  
(Legal Affairs Department)  
Floor 25, Metropole Square  
No.2 On Yiu Street, Shatin, New Territories,  
HONG KONG



---

[11] 1913571.6M016

[15] 02-05-2019

[51] Cl. 11-01

[54] 飾物設計

Ornament design

[73] 六福集團有限公司

Luk Fook Holdings Company Limited  
Floor 15, 20, 25 & 27, Metropole Square,  
No.2 On Yiu Street, Shatin, New Territories,  
HONG KONG

[74] Luk Fook Holdings Company Limited  
(Legal Affairs Department)  
Floor 25, Metropole Square  
No.2 On Yiu Street, Shatin, New Territories,  
HONG KONG



---

[11] 1913571.6M017

[15] 02-05-2019

[51] Cl. 11-01

[54] 飾物設計

Ornament design

[73] 六福集團有限公司

Luk Fook Holdings Company Limited  
Floor 15, 20, 25 & 27, Metropole Square,  
No.2 On Yiu Street, Shatin, New Territories,  
HONG KONG

[74] Luk Fook Holdings Company Limited

(Legal Affairs Department)

Floor 25, Metropole Square  
No.2 On Yiu Street, Shatin, New Territories,  
HONG KONG



---

[11] 1913571.6M018

[15] 02-05-2019

[51] Cl. 11-01

[54] 飾物設計

Ornament design

[73] 六福集團有限公司

Luk Fook Holdings Company Limited  
Floor 15, 20, 25 & 27, Metropole Square,  
No.2 On Yiu Street, Shatin, New Territories,  
HONG KONG

[74] Luk Fook Holdings Company Limited

(Legal Affairs Department)

Floor 25, Metropole Square  
No.2 On Yiu Street, Shatin, New Territories,  
HONG KONG



---

[11] 1913571.6M019

[15] 02-05-2019

[51] Cl. 11-01

[54] 飾物設計

Ornament design

[73] 六福集團有限公司

Luk Fook Holdings Company Limited  
Floor 15, 20, 25 & 27, Metropole Square,  
No.2 On Yiu Street, Shatin, New Territories,  
HONG KONG

[74] Luk Fook Holdings Company Limited

(Legal Affairs Department)  
Floor 25, Metropole Square  
No.2 On Yiu Street, Shatin, New Territories,  
HONG KONG



---

[11] 1913571.6M020



[15] 02-05-2019

[51] Cl. 11-01

[54] 飾物設計

Ornament design

[73] 六福集團有限公司

Luk Fook Holdings Company Limited

Floor 15, 20, 25 & 27, Metropole Square,

No.2 On Yiu Street, Shatin, New Territories,

HONG KONG

[74] Luk Fook Holdings Company Limited

(Legal Affairs Department)

Floor 25, Metropole Square

No.2 On Yiu Street, Shatin, New Territories,

HONG KONG



---

[11] 1913575.5

[15] 03-05-2019

[51] Cl. 20-02

[54] 飾物陳列裝置

Ornament display device

[73] 金至尊國際有限公司

3D-GOLD INTERNATIONAL COMPANY LIMITED

UNITS 01-09, 17TH FLOOR, PENINSULA SQUARE,

NO.18 SUNG ON STREET, HUNGHOM, KOWLOON, HONG KONG

[74] 3D-GOLD INTERNATIONAL COMPANY LIMITED(ATTN TO IRENE CHEUNG)

UNITS 01-09, 17TH FLOOR, PENINSULA SQUARE,

NO. 18 SUNG ON STREET, HUNGHOM,

KOWLOON., HONG KONG



---

[11] 1913576.7M001

[15] 03-05-2019

[51] Cl. 11-01

[54] 飾物設計

Ornament design

[73] 金至尊國際有限公司

3D-GOLD INTERNATIONAL COMPANY LIMITED

UNITS 01-09, 17TH FLOOR, PENINSULA SQUARE,

NO.18 SUNG ON STREET, HUNGHOM, KOWLOON, HONG KONG

[74] 3D-GOLD INTERNATIONAL COMPANY LIMITED (ATTN TO IRENE CHEUNG)

UNITS 01-09, 17TH FLOOR, PENINSULA SQUARE,

NO. 18 SUNG ON STREET, HUNGHOM,

KOWLOON., HONG KONG



---

[11] 1913576.7M002

[15] 03-05-2019

[51] Cl. 11-01

[54] 飾物設計

Ornament design

[73] 金至尊國際有限公司

3D-GOLD INTERNATIONAL COMPANY LIMITED

UNITS 01-09, 17TH FLOOR, PENINSULA SQUARE,  
NO.18 SUNG ON STREET, HUNGHOM, KOWLOON, HONG KONG

- [74] 3D-GOLD INTERNATIONAL COMPANY LIMITED (ATTN TO IRENE CHEUNG)  
UNITS 01-09, 17TH FLOOR, PENINSULA SQUARE,  
NO. 18 SUNG ON STREET, HUNGHOM,  
KOWLOON., HONG KONG

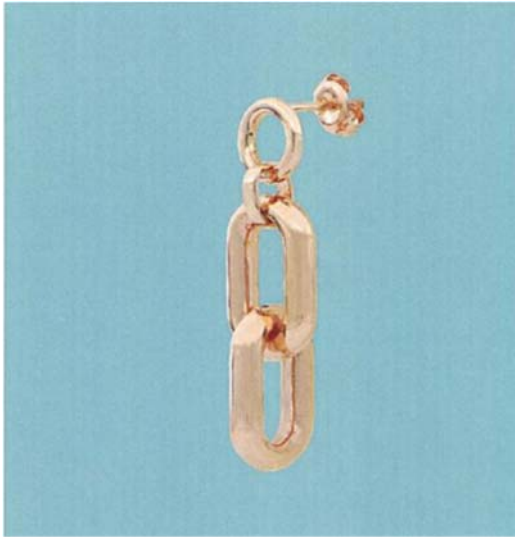

- 
- [11] 1913576.7M003

- [15] 03-05-2019

- [51] Cl. 11-01

- [54] 飾物設計

Ornament design

- [73] 金至尊國際有限公司

3D-GOLD INTERNATIONAL COMPANY LIMITED  
UNITS 01-09, 17TH FLOOR, PENINSULA SQUARE,  
NO.18 SUNG ON STREET, HUNGHOM, KOWLOON, HONG KONG

- [74] 3D-GOLD INTERNATIONAL COMPANY LIMITED (ATTN TO IRENE CHEUNG)  
UNITS 01-09, 17TH FLOOR, PENINSULA SQUARE,  
NO. 18 SUNG ON STREET, HUNGHOM,  
KOWLOON., HONG KONG



---

[11] 1913577.9M001

[15] 03-05-2019

[51] Cl. 11-01

[54] 飾物設計

Ornament design

[73] 金至尊國際有限公司

3D-GOLD INTERNATIONAL COMPANY LIMITED  
UNITS 01-09, 17TH FLOOR, PENINSULA SQUARE,  
NO.18 SUNG ON STREET, HUNGHOM, KOWLOON, HONG KONG

[74] 3D-GOLD INTERNATIONAL COMPANY LIMITED (ATTN TO IRENE CHEUNG)

UNITS 01-09, 17TH FLOOR, PENINSULA SQUARE,  
NO. 18 SUNG ON STREET, HUNGHOM,  
KOWLOON, HONG KONG

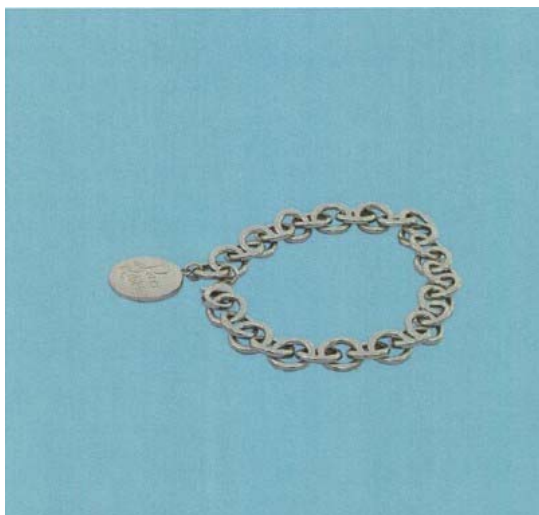

---

[11] 1913577.9M002

[15] 03-05-2019

[51] Cl. 11-01

[54] 飾物設計

Ornament design

[73] 金至尊國際有限公司

3D-GOLD INTERNATIONAL COMPANY LIMITED

UNITS 01-09, 17TH FLOOR, PENINSULA SQUARE,

NO.18 SUNG ON STREET, HUNGHOM, KOWLOON, HONG KONG

[74] 3D-GOLD INTERNATIONAL COMPANY LIMITED (ATTN TO IRENE CHEUNG)

UNITS 01-09, 17TH FLOOR, PENINSULA SQUARE,

NO. 18 SUNG ON STREET, HUNGHOM,

KOWLOON, HONG KONG



---

[11] 1913577.9M003

[15] 03-05-2019

[51] Cl. 11-01

[54] 飾物設計

Ornament design

[73] 金至尊國際有限公司

3D-GOLD INTERNATIONAL COMPANY LIMITED

UNITS 01-09, 17TH FLOOR, PENINSULA SQUARE,

NO.18 SUNG ON STREET, HUNGHOM, KOWLOON, HONG KONG

[74] 3D-GOLD INTERNATIONAL COMPANY LIMITED (ATTN TO IRENE CHEUNG)

UNITS 01-09, 17TH FLOOR, PENINSULA SQUARE,

NO. 18 SUNG ON STREET, HUNGHOM,

KOWLOON, HONG KONG



[11] 1913577.9M004

[15] 03-05-2019

[51] Cl. 11-01

[54] 飾物設計

Ornament design

[73] 金至尊國際有限公司

3D-GOLD INTERNATIONAL COMPANY LIMITED  
UNITS 01-09, 17TH FLOOR, PENINSULA SQUARE,  
NO.18 SUNG ON STREET, HUNGHOM, KOWLOON, HONG KONG

[74] 3D-GOLD INTERNATIONAL COMPANY LIMITED (ATTN TO IRENE CHEUNG)

UNITS 01-09, 17TH FLOOR, PENINSULA SQUARE,  
NO. 18 SUNG ON STREET, HUNGHOM,  
KOWLOON, HONG KONG



[11] 1913578.1M001

[15] 03-05-2019

[51] Cl. 11-01

[54] 飾物設計

Ornament design

[73] 金至尊國際有限公司

3D-GOLD INTERNATIONAL COMPANY LIMITED

UNITS 01-09, 17TH FLOOR, PENINSULA SQUARE, NO.18 SUNG ON STREET, HUNGHOM, KOWLOON, HONG KONG

[74] 3D-GOLD INTERNATIONAL COMPANY LIMITED (ATTN TO IRENE CHEUNG)

UNITS 01-09, 17TH FLOOR, PENINSULA SQUARE,  
NO. 18 SUNG ON STREET, HUNGHOM,  
KOWLOON, HONG KONG



---

[11] 1913578.1M002

[15] 03-05-2019

[51] Cl. 11-01

[54] 飾物設計

Ornament design

[73] 金至尊國際有限公司

3D-GOLD INTERNATIONAL COMPANY LIMITED

UNITS 01-09, 17TH FLOOR, PENINSULA SQUARE, NO.18 SUNG ON STREET, HUNGHOM, KOWLOON, HONG KONG

[74] 3D-GOLD INTERNATIONAL COMPANY LIMITED (ATTN TO IRENE CHEUNG)

UNITS 01-09, 17TH FLOOR, PENINSULA SQUARE,  
NO. 18 SUNG ON STREET, HUNGHOM,  
KOWLOON, HONG KONG



---

[11] 1913578.1M003

[15] 03-05-2019

[51] Cl. 11-01

[54] 飾物設計

Ornament design

[73] 金至尊國際有限公司

3D-GOLD INTERNATIONAL COMPANY LIMITED

UNITS 01-09, 17TH FLOOR, PENINSULA SQUARE, NO.18 SUNG ON STREET, HUNGHOM, KOWLOON, HONG KONG

[74] 3D-GOLD INTERNATIONAL COMPANY LIMITED (ATTN TO IRENE CHEUNG)

UNITS 01-09, 17TH FLOOR, PENINSULA SQUARE,

NO. 18 SUNG ON STREET, HUNGHOM,

KOWLOON, HONG KONG

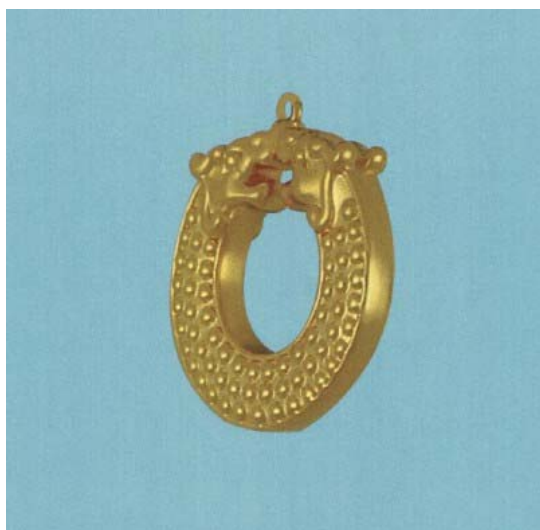

---

[11] 1913578.1M004



[15] 03-05-2019

[51] Cl. 11-01

[54] 飾物設計

Ornament design

[73] 金至尊國際有限公司

3D-GOLD INTERNATIONAL COMPANY LIMITED

UNITS 01-09, 17TH FLOOR, PENINSULA SQUARE, NO.18 SUNG ON STREET, HUNGHOM, KOWLOON, HONG KONG

[74] 3D-GOLD INTERNATIONAL COMPANY LIMITED (ATTN TO IRENE CHEUNG)

UNITS 01-09, 17TH FLOOR, PENINSULA SQUARE,  
NO. 18 SUNG ON STREET, HUNGHOM,  
KOWLOON, HONG KONG

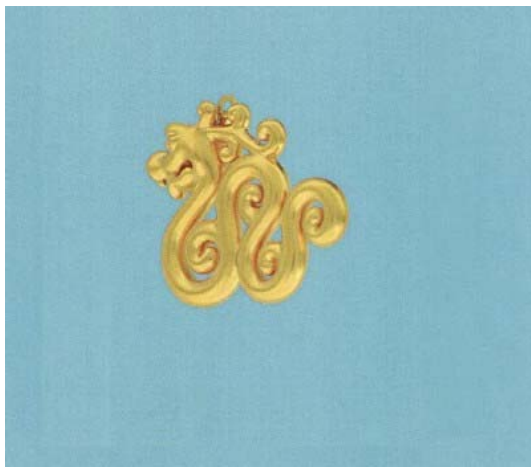

---

[11] 1913578.1M005

[15] 03-05-2019

[51] Cl. 11-01

[54] 飾物設計

Ornament design

[73] 金至尊國際有限公司

3D-GOLD INTERNATIONAL COMPANY LIMITED

UNITS 01-09, 17TH FLOOR, PENINSULA SQUARE, NO.18 SUNG ON STREET, HUNGHOM, KOWLOON, HONG KONG

[74] 3D-GOLD INTERNATIONAL COMPANY LIMITED (ATTN TO IRENE CHEUNG)

UNITS 01-09, 17TH FLOOR, PENINSULA SQUARE,  
NO. 18 SUNG ON STREET, HUNGHOM,  
KOWLOON, HONG KONG



---

[11] 1913578.1M006

[15] 03-05-2019

[51] Cl. 11-01

[54] 飾物設計

Ornament design

[73] 金至尊國際有限公司

3D-GOLD INTERNATIONAL COMPANY LIMITED

UNITS 01-09, 17TH FLOOR, PENINSULA SQUARE, NO.18 SUNG ON STREET, HUNGHOM, KOWLOON, HONG KONG

[74] 3D-GOLD INTERNATIONAL COMPANY LIMITED (ATTN TO IRENE CHEUNG)

UNITS 01-09, 17TH FLOOR, PENINSULA SQUARE,

NO. 18 SUNG ON STREET, HUNGHOM,

KOWLOON, HONG KONG



---

[11] 1913578.1M007

[15] 03-05-2019

[51] Cl. 11-01

[54] 飾物設計

Ornament design

[73] 金至尊國際有限公司

3D-GOLD INTERNATIONAL COMPANY LIMITED

UNITS 01-09, 17TH FLOOR, PENINSULA SQUARE, NO.18 SUNG ON STREET, HUNGHOM, KOWLOON, HONG KONG

[74] 3D-GOLD INTERNATIONAL COMPANY LIMITED (ATTN TO IRENE CHEUNG)

UNITS 01-09, 17TH FLOOR, PENINSULA SQUARE,  
NO. 18 SUNG ON STREET, HUNGHOM,  
KOWLOON, HONG KONG



---

[11] 1913578.1M008

[15] 03-05-2019

[51] Cl. 11-01

[54] 飾物設計

Ornament design

[73] 金至尊國際有限公司

3D-GOLD INTERNATIONAL COMPANY LIMITED

UNITS 01-09, 17TH FLOOR, PENINSULA SQUARE, NO.18 SUNG ON STREET, HUNGHOM, KOWLOON, HONG KONG

[74] 3D-GOLD INTERNATIONAL COMPANY LIMITED (ATTN TO IRENE CHEUNG)

UNITS 01-09, 17TH FLOOR, PENINSULA SQUARE,  
NO. 18 SUNG ON STREET, HUNGHOM,  
KOWLOON, HONG KONG



[11] 1913578.1M009

[15] 03-05-2019

[51] Cl. 11-01

[54] 飾物設計

Ornament design

[73] 金至尊國際有限公司

3D-GOLD INTERNATIONAL COMPANY LIMITED

UNITS 01-09, 17TH FLOOR, PENINSULA SQUARE, NO.18 SUNG ON STREET, HUNGHOM, KOWLOON, HONG KONG

[74] 3D-GOLD INTERNATIONAL COMPANY LIMITED (ATTN TO IRENE CHEUNG)

UNITS 01-09, 17TH FLOOR, PENINSULA SQUARE,  
NO. 18 SUNG ON STREET, HUNGHOM,  
KOWLOON, HONG KONG



[11] 1913578.1M010

[15] 03-05-2019

[51] Cl. 11-01

[54] 飾物設計

Ornament design

[73] 金至尊國際有限公司

3D-GOLD INTERNATIONAL COMPANY LIMITED

UNITS 01-09, 17TH FLOOR, PENINSULA SQUARE, NO.18 SUNG ON STREET, HUNGHOM, KOWLOON, HONG KONG

[74] 3D-GOLD INTERNATIONAL COMPANY LIMITED (ATTN TO IRENE CHEUNG)

UNITS 01-09, 17TH FLOOR, PENINSULA SQUARE,  
NO. 18 SUNG ON STREET, HUNGHOM,  
KOWLOON, HONG KONG



---

[11] 1913578.1M011

[15] 03-05-2019

[51] Cl. 11-01

[54] 飾物設計

Ornament design

[73] 金至尊國際有限公司

3D-GOLD INTERNATIONAL COMPANY LIMITED

UNITS 01-09, 17TH FLOOR, PENINSULA SQUARE, NO.18 SUNG ON STREET, HUNGHOM, KOWLOON, HONG KONG

[74] 3D-GOLD INTERNATIONAL COMPANY LIMITED (ATTN TO IRENE CHEUNG)

UNITS 01-09, 17TH FLOOR, PENINSULA SQUARE,  
NO. 18 SUNG ON STREET, HUNGHOM,  
KOWLOON, HONG KONG

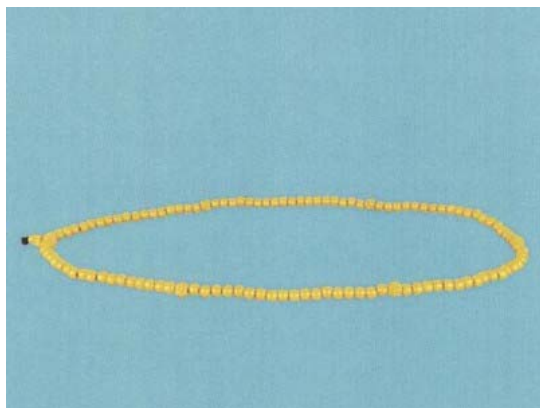

---

[11] 1913581.7

[15] 03-05-2019

[30] 05-11-2018 / DE / 40 2018 101 128.2

[51] Cl. 21-01

[54] 玩具汽車

Toy vehicle

[73] VOLKSWAGEN AKTIENGESELLSCHAFT

38436 WOLFSBURG

GERMANY

[74] CHINA PATENT AGENT (HONG KONG) LIMITED

22/F, Great Eagle Centre, 23 Harbour Road, Wanchai

HONG KONG



---

[11] 1913628.8

[15] 14-05-2019

[51] Cl. 21-01

[54] 玩具

Toy

[73] Dragon Rainbow Limited

Level 2, 1 Lam Wah Street, Kowloon Bay, Kowloon

HONG KONG

[74] CHINAHONGKONG IP LIMITED  
3011, 30/F, Office Tower, Convention Plaza, 1 Harbour Road  
HONG KONG



---

[11] 1913631.4  
[15] 15-05-2019  
[30] 12-02-2019 / DE / 40 2019 100 179.4  
[51] Cl. 21-01  
[54] 玩具汽車  
Toy vehicle

[73] VOLKSWAGEN AKTIENGESELLSCHAFT  
38436 WOLFSBURG  
GERMANY

[74] CHINA PATENT AGENT (HONG KONG) LIMITED  
22/F, Great Eagle Centre, 23 Harbour Road, Wanchai  
HONG KONG



---

[11] 1913645.4  
[15] 16-05-2019  
[30] 09-01-2019 / DE / 40 2019 100 017.8  
[51] Cl. 21-01  
[54] 玩具汽車  
Toy vehicle

[73] VOLKSWAGEN AKTIENGESELLSCHAFT  
38436 WOLFSBURG  
GERMANY

[74] CHINA PATENT AGENT (HONG KONG) LIMITED  
22/F, Great Eagle Centre, 23 Harbour Road, Wanchai  
HONG KONG



---

[11] 1913655.5

[15] 17-05-2019

[30] 22-11-2018 / DE / 40 2018 101 194.0

[51] Cl. 21-01

[54] 玩具或比例模型車

Toy or scale model vehicle

[73] Bayerische Motoren Werke Aktiengesellschaft

Petuelring 130

80809 Muenchen

GERMANY

[74] HASTINGS & CO

5/F Gloucester Tower, The Landmark,

11 Pedder Street, Central,

HONG KONG



---

[11] 1913659.3M001

[15] 17-05-2019

[30] 20-11-2018 / DE / 4 02018 101 182.7

[51] Cl. 21-01

[54] 玩具或比例模型車

Toy or Scale Model Vehicle

[73] Bayerische Motoren Werke Aktiengesellschaft

Petuelring 130



80809 Muenchen

GERMANY

[74] HASTINGS & CO  
5/F Gloucester Tower, The Landmark,  
11 Pedder Street, Central,  
HONG KONG



---

[11] 1913659.3M002  
[15] 17-05-2019  
[30] 20-11-2018 / DE / 4 02018 101 182.7  
[51] Cl. 21-01  
[54] 玩具或比例模型車  
Toy or Scale Model Vehicle  
[73] Bayerische Motoren Werke Aktiengesellschaft  
Petuelring 130  
80809 Muenchen  
GERMANY  
[74] HASTINGS & CO  
5/F Gloucester Tower, The Landmark,  
11 Pedder Street, Central,  
HONG KONG



---

[11] 1913663.1M001  
[15] 17-05-2019  
[51] Cl. 21-01

[54] 玩具車

Toy car [73]

銀輝號有限公司

SILVERLIT LIMITED

Room 1704, World Trade Centre,  
280 Gloucester Road, Causeway Bay,  
HONG KONG

[74] SILVERLJT LIMITED

Room 1704, World Trade Centre,  
80 Gloucester Road, Causeway Bay,  
HONG KONG



---

[11] 1913663.1M002

[15] 17-05-2019

[51] Cl. 21-01

[54] 玩具車

Toy car [73]

銀輝號有限公司

SILVERLIT LIMITED

Room 1704, World Trade Centre,  
280 Gloucester Road, Causeway Bay,  
HONG KONG

[74] SILVERLJT LIMITED

Room 1704, World Trade Centre,  
80 Gloucester Road, Causeway Bay,  
HONG KONG



---

[11] 1913663.1M003

[15] 17-05-2019

[51] Cl. 21-01

[54] 玩具狗

Toy dog [73]

銀輝號有限公司

SILVERLIT LIMITED

Room 1704, World Trade Centre,  
280 Gloucester Road, Causeway Bay,  
HONG KONG

[74] SILVERLJT LIMITED

Room 1704, World Trade Centre,  
80 Gloucester Road, Causeway Bay,  
HONG KONG

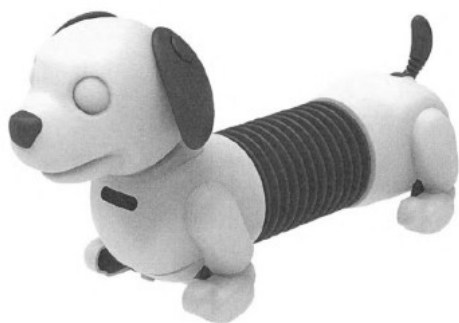

---

[11] 1913663.1M004

[15] 17-05-2019

[51] Cl. 21-01

[54] 玩具兔

Toy rabbit

[73] 銀輝號有限公司

SILVERLIT LIMITED

Room 1704, World Trade Centre,

280 Gloucester Road, Causeway Bay,  
HONG KONG

[74] SILVERLJT LIMITED  
Room 1704, World Trade Centre,  
80 Gloucester Road, Causeway Bay,  
HONG KONG



---

[11] 1913663.1M005

[15] 17-05-2019

[51] Cl. 21-01

[54] 玩具貓

Toy cat [73]

銀輝號有限公司

SILVERLIT LIMITED

Room 1704, World Trade Centre,  
280 Gloucester Road, Causeway Bay,  
HONG KONG

[74] SILVERLJT LIMITED  
Room 1704, World Trade Centre,  
80 Gloucester Road, Causeway Bay,  
HONG KONG



---

[11] 1913663.1M006

[15] 17-05-2019

[51] Cl. 21-01

[54] 玩具熊

Toy bear

[73] 銀輝號有限公司

SILVERLIT LIMITED  
Room 1704, World Trade Centre,  
280 Gloucester Road, Causeway Bay,  
HONG KONG

[74] SILVERLJT LIMITED

Room 1704, World Trade Centre,  
80 Gloucester Road, Causeway Bay,  
HONG KONG



---

[11] 1913663.1M007

[15] 17-05-2019

[51] Cl. 21-01

[54] 玩具

Toy

[73] 銀輝號有限公司

SILVERLIT LIMITED  
Room 1704, World Trade Centre,  
280 Gloucester Road, Causeway Bay,  
HONG KONG

[74] SILVERLJT LIMITED

Room 1704, World Trade Centre,  
80 Gloucester Road, Causeway Bay,  
HONG KONG



---

[11] 1913663.1M008

[15] 17-05-2019

[51] Cl. 21-01

[54] 玩具

Toy

[73] 銀輝號有限公司

SILVERLIT LIMITED

Room 1704, World Trade Centre,  
280 Gloucester Road, Causeway Bay,  
HONG KONG

[74] SILVERLJT LIMITED

Room 1704, World Trade Centre,  
80 Gloucester Road, Causeway Bay,  
HONG KONG



---

[11] 1913663.1M009

[15] 17-05-2019

[51] Cl. 21-01

[54] 玩具

Toy

[73] 銀輝號有限公司

SILVERLIT LIMITED

Room 1704, World Trade Centre,  
280 Gloucester Road, Causeway Bay,  
HONG KONG

[74] SILVERLJT LIMITED

Room 1704, World Trade Centre,  
80 Gloucester Road, Causeway Bay,  
HONG KONG



---

[11] 1913663.1M010

[15] 17-05-2019

[51] Cl. 21-01

[54] 玩具

Toy

[73] 銀輝號有限公司

SILVERLIT LIMITED

Room 1704, World Trade Centre,

280 Gloucester Road, Causeway Bay,

HONG KONG

[74] SILVERLJT LIMITED

Room 1704, World Trade Centre,

80 Gloucester Road, Causeway Bay,

HONG KONG



---

[11] 1913663.1M011

[15] 17-05-2019

[51] Cl. 21-01

[54] 玩具

Toy

[73] 銀輝號有限公司

SILVERLIT LIMITED  
Room 1704, World Trade Centre,  
280 Gloucester Road, Causeway Bay,  
HONG KONG

[74] SILVERLJT LIMITED

Room 1704, World Trade Centre,  
80 Gloucester Road, Causeway Bay,  
HONG KONG



---

[11] 1913663.1M012

[15] 17-05-2019

[51] Cl. 21-01

[54] 玩具

Toy

[73] 銀輝號有限公司

SILVERLIT LIMITED  
Room 1704, World Trade Centre,  
280 Gloucester Road, Causeway Bay,  
HONG KONG

[74] SILVERLJT LIMITED

Room 1704, World Trade Centre,  
80 Gloucester Road, Causeway Bay,  
HONG KONG





---

[11] 1913671.8

[15] 17-05-2019

[30] 29-04-2019 / EU / 006405577-0001

[51] Cl. 21-01

[54] 立方遊戲

Cube games

[73] Colémoi

10 rue de Penthièvre

75 008 PARIS

FRANCE

[74] BENNY KONG & TSAI

Unit 19B, Overseas Trust Bank Building

No. 160 Gloucester Road, Wanchai

HONG KONG

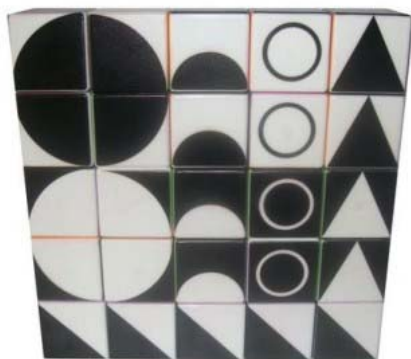

---

[11] 1913701.3M001

[15] 22-05-2019

[30] 03-12-2018 / EU, MC, IS, JP, LI, OM, KR, SG, CH, UA, GB, TR,  
RU / 970003099

[51] Cl. 10-02

[54] 手錶

Watch

[73] Turlen Holding SA

Rue du Jura 11,  
2345 Les Breuleux,  
SWITZERLAND

[74] WILKINSON & GRIST

6th Floor, Prince's Building  
Chater Road  
HONG KONG

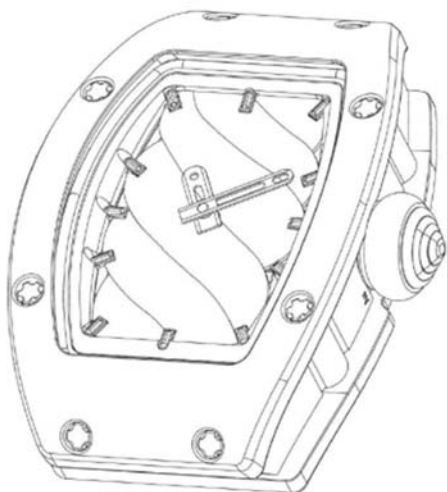

---

[11] 1913701.3M002

[15] 22-05-2019

[30] 03-12-2018 / EU, MC, IS, JP, LI, OM, KR, SG, CH, UA, GB, TR,  
RU / 970003099

[51] Cl. 10-02

[54] 手錶

Watch

[73] Turlen Holding SA

Rue du Jura 11,  
2345 Les Breuleux,  
SWITZERLAND

[74] WILKINSON & GRIST

6th Floor, Prince's Building  
Chater Road  
HONG KONG



---

[11] 1913701.3M003

[15] 22-05-2019

[30] 03-12-2018 / EU, MC, IS, JP, LI, OM, KR, SG, CH, UA, GB, TR,  
RU / 970003099

[51] Cl. 10-02

[54] 手錶

Watch

[73] Turlen Holding SA  
Rue du Jura 11,  
2345 Les Breuleux,  
SWITZERLAND

[74] WILKINSON & GRIST  
6th Floor, Prince's Building  
Chater Road  
HONG KONG

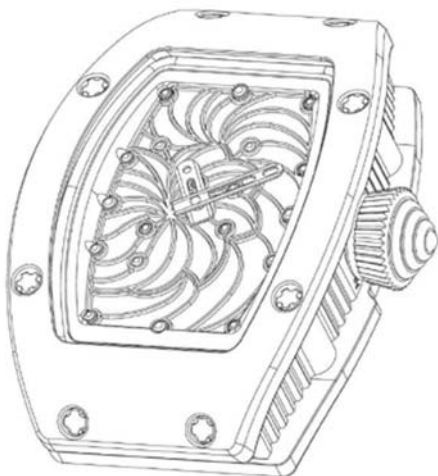

[11] 1913701.3M004

[15] 22-05-2019

[30] 03-12-2018 / EU, MC, IS, JP, LI, OM, KR, SG, CH, UA, GB, TR,  
RU / 970003099

[51] Cl. 10-02

[54] 手錶

Watch

[73] Turlen Holding SA

Rue du Jura 11,  
2345 Les Breuleux,  
SWITZERLAND

[74] WILKINSON & GRIST

6th Floor, Prince's Building  
Chater Road  
HONG KONG

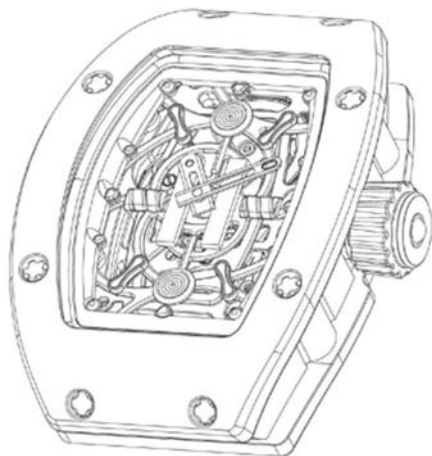

[11] 1913701.3M005

[15] 22-05-2019

[30] 03-12-2018 / EU, MC, IS, JP, LI, OM, KR, SG, CH, UA, GB, TR,  
RU / 970003099

[51] Cl. 10-02

[54] 手錶

Watch

[73] Turlen Holding SA

Rue du Jura 11,  
2345 Les Breuleux,  
SWITZERLAND

[74] WILKINSON & GRIST

6th Floor, Prince's Building

Chater Road  
HONG KONG



---

[11] 1913701.3M006

[15] 22-05-2019

[30] 03-12-2018 / EU, MC, IS, JP, LI, OM, KR, SG, CH, UA, GB, TR,  
RU / 970003099

[51] Cl. 10-02

[54] 手錶

Watch

[73] Turlen Holding SA  
Rue du Jura 11,  
2345 Les Breuleux,  
SWITZERLAND

[74] WILKINSON & GRIST  
6th Floor, Prince's Building  
Chater Road  
HONG KONG



---

[11] 1913773.4

[15] 30-05-2019

[51] Cl. 21-01

[54] 積木玩具

Toy building block

[73] Royal Toys (HK) Co., Limited

香港荃灣

橫龍街 55-57 號

利時工業大廈 7 樓

[74] Royal Toys (HK) Co., Limited

香港荃灣

橫龍街 55-57 號

利時工業大廈 7 樓



---

[11] 1913774.6

[15] 30-05-2019

[51] Cl. 21-01

[54] 積木玩具

Toy building block

[73] Royal Toys (HK) Co., Limited

7/F, Leitz Industrial Building, 55-57 Wang Lung Street, Tsuen Wan, N.T.,  
Hong Kong

[74] Royal Toys (HK) Co., Limited

7/F, Leitz Industrial Building, 55-57 Wang Lung Street,  
Tsuen Wan, N.T., Hong Kong



---

[11] 1913945.0

[15] 11-06-2019

[51] Cl. 21-01

[54] 玩具槍

Toy gun

[73] Buzz Bee Toys (HK) Co., Limited

Units 1206-1208, Tower B, New Mandarin Plaza,  
14 Science Museum Road, Tsim Sha Tsui East,  
Kowloon, HONG KONG

[74] INCOMPASS IP LIMITED

532B, 5/F, Core Building 2, Phase One,  
Hong Kong Science Park, Pak Shek Kok,  
HONG KONG



---

[11] 1914033.6

[15] 20-06-2019

[30] 20-12-2018 / CN / 201830741100.9

[51] Cl. 21-01

[54] 拋接球用具

Device for throwing and receiving a ball

[73] 陳少芸

中國內地

廣東省汕頭市澄海區澄華街道西門德政路

澄江花園二期 6 幢 402 房

[74] 中港知識產權有限公司

香港

港灣道 1 號會展廣場辦公大樓 30 樓 3011 室

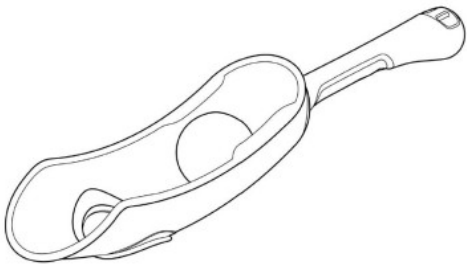





香港特別行政區政府知識產權署外觀設計註冊處

The Government of the Hong Kong Special Administrative Region

Designs Registry, Intellectual Property Department

**根據註冊外觀設計條例第28條，下列註冊外觀設計因未繳續期費而停止有效。各組記項按註冊外觀設計停止有效日期及註冊編號先後次序排列。**

**Registered designs ceased through non-payment of renewal fees under section 28 of the Registered Designs Ordinance. Entries are listed below under their expiry dates.**

**14-09-2019 - 18-09-2019**

<b>14-09-2019</b>	1401718.0	1401731.7M002
1401701.4	1401724.2	1401732.9M001
1401702.6	9911245.0	1401732.9M002
1401703.8M001		1401732.9M003
1401703.8M002	<b>18-09-2019</b>	1401732.9M004
1401704.0	1401725.5M001	1401732.9M005
1401705.3	1401725.5M002	1401732.9M006
	1401725.5M003	1401732.9M007
<b>15-09-2019</b>	1401725.5M004	1401732.9M008
0412109.9	1401725.5M005	1401732.9M009
0412110.1M001	1401725.5M006	1401732.9M010
0412110.1M002	1401725.5M007	1401732.9M011
0412111.3	1401725.5M008	1401732.9M012
0901509.0M001	1401725.5M009	1401732.9M013
0901509.0M002	1401725.5M010	1401732.9M014
0901509.0M003	1401725.5M011	1401733.1M005
1401707.7M001	1401725.5M012	1401733.1M006
1401707.7M002	1401725.5M013	
	1401725.5M014	
<b>16-09-2019</b>	1401725.5M015	
0412130.3	1401725.5M016	
0412131.5	1401725.5M017	
0901516.5	1401725.5M018	
0901517.7M001	1401725.5M019	
1401713.9	1401725.5M020	
1401714.1M001	1401725.5M021	
1401714.1M002	1401725.5M022	
1401715.4M001	1401727.9M001	
1401715.4M002	1401727.9M002	
1401716.6M001	1401728.1	
1401716.6M002	1401729.3M001	
1401716.6M004	1401729.3M002	
	1401730.5	
<b>17-09-2019</b>	1401731.7M001	



香港特別行政區政府知識產權署外觀設計註冊處

The Government of the Hong Kong Special Administrative Region

Designs Registry, Intellectual Property Department

根據註冊外觀設計規則第 31 條刪除的註冊外觀設計。各組記項按註冊外觀設計 刪除日期及註冊編號先後次序排列。

Registered designs removed under section 31 of the Registered Designs Rules. Entries are listed below under their removal dates.

**20-09-2019 - 26-09-2019**

<b>20-09-2019</b>	1400464.8	1400478.8M032
0900398.1M001	1400465.1	1400478.8M033
0900398.1M003	1400466.3	1400478.8M034
0900398.1M006	1400478.8M001	1400478.8M035
0900399.3	1400478.8M002	
0900401.9	1400478.8M003	<b>25-09-2019</b>
1400443.4M001	1400478.8M004	0900419.7
1400443.4M002	1400478.8M005	0900423.5
1400446.1	1400478.8M006	0900426.2
1400447.3	1400478.8M007	1400490.3M001
1400448.5	1400478.8M008	1400490.3M002
1400450.9	1400478.8M009	1400490.3M003
1400451.1	1400478.8M010	1400491.5M001
	1400478.8M011	1400491.5M002
<b>21-09-2019</b>	1400478.8M012	
1400452.3	1400478.8M013	<b>26-09-2019</b>
1400453.5	1400478.8M014	0410625.2
1400455.0	1400478.8M015	1400492.7
1400456.2	1400478.8M016	1400493.9M001
1400457.4	1400478.8M017	1400493.9M002
1400459.8	1400478.8M018	1400497.8
1400460.0	1400478.8M019	1400498.0
1400461.2	1400478.8M020	1400499.2M001
1400462.4M001	1400478.8M021	1400499.2M002
1400462.4M002	1400478.8M022	1400499.2M003
	1400478.8M023	1400499.2M004
<b>24-09-2019</b>	1400478.8M024	9910328.5
0410593.2	1400478.8M025	
0410594.4	1400478.8M026	
0410595.7	1400478.8M027	
0410596.9	1400478.8M028	
0410597.1	1400478.8M029	
0410598.3	1400478.8M030	
0900408.4	1400478.8M031	