

香港知識產權公報

Hong Kong Intellectual Property Journal

2020 年 6 月 12 日

12 June 2020

目錄 Contents

根據註冊外觀設計條例第 25 條註冊的外觀設計

Designs Registered under section 25 of the Registered Designs Ordinance

按註冊編號排列

Arranged by Registration Number

根據註冊外觀設計條例(第 522 章)公布的其他公告

Other Notices Published under the Registered Designs Ordinance (Cap. 522)

根據註冊外觀設計條例第 28 條，註冊外觀設計因未繳續期費而停止有效

Registered designs ceased through non-payment of renewal fees under section 28 of the Registered Designs Ordinance

根據註冊外觀設計規則第 31 條刪除的註冊外觀設計

Registered designs removed under section 31 of the Registered Designs Rules

根據註冊外觀設計條例第 76 條，更正已提交文件中的錯誤

Correction of errors in filed documents under section 76 of the Registered Designs Ordinance

以下事項沒有記錄

No Records for the Following Matters

根據註冊外觀設計條例第 30 條放棄的外觀設計的註冊

Surrender of Registration of Design under section 30 of the Registered Designs Ordinance

根據註冊外觀設計規則第 37 條，向處長作出轉介

Reference to Registrar under section 37 of the Registered Designs Rules

根據註冊外觀設計條例第 45 條，撤銷註冊

Revocation of Registration under section 45 of the Registered Designs Ordinance

根據註冊外觀設計規則第 46 條，向法院作出轉介

Reference to Court under section 46 of the Registered Designs Rules

根據註冊外觀設計規則第 63 條對不符合規定之處作出糾正

Rectification of Irregularities under section 63 of the Registered Designs Rules

根據註冊外觀設計條例第 66 條，糾正註冊紀錄冊

Rectification of Register under section 66 of the Registered Designs Ordinance

根據註冊外觀設計條例第 67 條 更正註冊紀錄冊內的錯誤

Correction of errors in Register under section 67 of the Registered Designs Ordinance

根據註冊外觀設計條例第 67 及 76 條，更正註冊紀錄冊內及已提交文件中的錯誤

Correction of Errors in Register and in Filed Documents under sections 67 and 76 of the Registered Designs Ordinance

勘誤

Corrigendum

註冊外觀設計公告註釋

Notes on advertisements of registration of designs

方括號表示下列資料：

Square brackets indicate the following data：

[11] 註冊編號 Registration number / 聯合王國註冊編號 United Kingdom registration number

[15] 註冊日期 Registration date / 當作註冊日期 Deemed registration date / 聯合王國註冊日期 United Kingdom registration date

[17] 註冊有效期屆滿日期 Expiry date of the period of registration

[22] 提交日期 Filing date / 當作提交日期 Deemed filing date / 聯合王國提交日期 United Kingdom filing date

[30] 聲稱享有的優先權（提交日期 / 巴黎公約國或世界貿易組織成員 / 申請編號） Priority claimed (filing date / Paris Convention country or WTO member / application number)

[51] 國際外觀設計分類號（洛迦諾分類號） International Classification of designs (Locarno Classification)

[54] 物品 Article

[55] 外觀設計的表述 Representation of the design

[62] 分開前的申請編號及提交日期 Application number before division and filing date

[66] 過往註冊的聯繫外觀設計註冊編號 / 日期 Registration No. / Date of Previous Registration for Association

[72] 設計人 Designer

[73] 擁有人姓名和地址 Name and address of the owner

[74] 代理人 Agent / 送達地址 Address for service



香港特別行政區政府知識產權署外觀設計註冊處

The Government of the Hong Kong Special Administrative Region

Designs Registry, Intellectual Property Department

根據註冊外觀設計條例第 25 條註冊的外觀設計

Designs registered under section 25 of the Registered Designs Ordinance

按註冊編號排列

Arranged by Registration Number

[11] 1802305.9M001

[15] 26-11-2018

[30] 20-09-2018 / CH / 144213

[51] Cl. 10-02

[54] 手錶

Wristwatch

[73] Luxury Goods International (L.G.I.) SA

Chemin des Rochettes 2,

2016 Cortaillod,

SWITZERLAND

[74] ATL Law Offices

16/F., China Hong Kong Tower,

8-12 Hennessy Road, Wanchai,

Hong Kong.



[11] 1802305.9M002

[15] 26-11-2018

[30] 20-09-2018 / CH / 144213

[51] Cl. 10-07

[54] 錶外框

Watch bezel

[73] Luxury Goods International (L.G.I.) SA

Chemin des Rochettes 2,

2016 Cortaillod,

SWITZERLAND

[74] ATL Law Offices

16/F., China Hong Kong Tower,

8-12 Hennessy Road, Wanchai,

Hong Kong.



[11] 1802305.9M003

[15] 26-11-2018

[30] 20-09-2018 / CH / 144213

[51] Cl. 10-02

[54] 錶

Watch

[73] Luxury Goods International (L.G.I.) SA

Chemin des Rochettes 2,

2016 Cortaillod,

SWITZERLAND

[74] ATL Law Offices

16/F., China Hong Kong Tower,

8-12 Hennessy Road, Wanchai,

Hong Kong.



[11] 1802305.9M004

[15] 26-11-2018

[30] 20-09-2018 / CH / 144213

[51] Cl. 10-02

[54] 手錶

Wristwatch

[73] Luxury Goods International (L.G.I.) SA
Chemin des Rochettes 2,
2016 Cortaillod,
SWITZERLAND

[74] ATL Law Offices
16/F., China Hong Kong Tower,
8-12 Hennessy Road, Wanchai,
Hong Kong.



- [11] 1914211.4
[15] 12-07-2019
[51] Cl. 11-01
[54] 星形珠寶
Star shaped Jewellery
[73] 卡芙邦鑽石
CATHYPAUL DIAMOND LIMITED
Flat A3, 3/F Carnarvon Maison,
8-10 Carnarvon Road, TST, Kowloon
HONG KONG
[74] GLOBAL INTELLECTUAL PROPERTY COMPANY LIMITED
Unit 2205, 22/F Sino Plaza,
255-257 Gloucester Road, Causeway Bay,
HONG KONG



-
- [11] 1914268.4
[15] 17-07-2019
[51] Cl. 2-07
[54] 雙層拉鍊
Double layer zipper
[73] 宜興市德林服飾科技有限公司
Yixing Delin Garments Technology Co., Ltd.
中國內地
江蘇省無錫市宜興市張渚鎮（犢山村）北環路南側犢山路西側
[74] 標準香港企業註冊服務有限公司
香港
香港九龍旺角彌敦道 678 號
華僑商業中心 15C



-
- [11] 1914280.9
[15] 19-07-2019
[30] 21-01-2019 / SG, CH, TR, GB, EU / DM/200614
[51] Cl. 10-07
[54] 手錶帶用釦子
Clasp for watch bracelet
[73] RICHEMONT INTERNATIONAL SA
Route des Biches 10
CH - 1752 Villars-sur-Glâne
SWITZERLAND
[74] UNION PATENT SERVICE CENTRE
Units E-F, 20th Floor, Neich Tower,
128 Gloucester Road,
HONG KONG

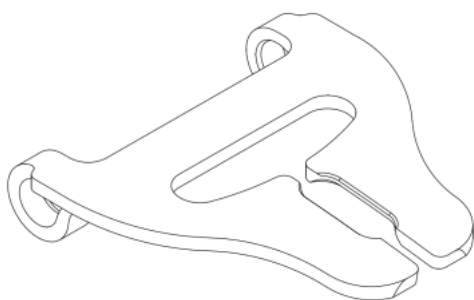

-
- [11] 1914289.8
[15] 22-07-2019
[51] Cl. 7-04
[54] 多功能切片器
Multi-function slicer
[73] LEE YUEN HOUSEWARES CO., LTD.
Unit G, 12/F., World Tech Centre,

95 How Ming Street, Kwun Tong, Kowloon,
HONG KONG

- [74] CHAN, TANG & KWOK
Rooms 2503-04, 25/F., Shanghai Industrial Investment Building,
48-62 Hennessy Road, Wanchai,
HONG KONG



-
- [11] 1914346.0
[15] 31-07-2019
[51] Cl. 7-07
[54] 收納籃
Storage basket
[73] 王維正
Wei-Cheng WANG
台灣
台北市瑞光路 268 號
7 樓
[74] HUEN Chi Chung
香港
香港九龍牛頭角
樂雅苑 D 座 808 室

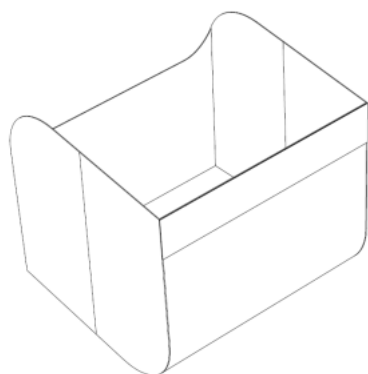

[11] 1914351.0M001

[15] 01-08-2019

[30] 01-02-2019 / US / 29/679,108

[51] Cl. 14-04

[54] 用於電子裝置螢幕顯示的三維人物

Three dimensional character for electronic device screen display

[73] 蘋果公司

APPLE INC.

ONE APPLE PARK WAY, CUPERTINO, CALIFORNIA 95014

UNITED STATES

[74] CLT PATENT & TRADEMARK (H.K.) LIMITED

Unit 09, 34/F., Office Tower, Convention Plaza

No. 1 Harbour Road, Wanchai

HONG KONG



[11] 1914351.0M002

[15] 01-08-2019

[30] 01-02-2019 / US / 29/679,108

[51] Cl. 14-04

- [54] 用於電子裝置螢幕顯示的三維人物
Three dimensional character for electronic device screen display
- [73] 蘋果公司
APPLE INC.
ONE APPLE PARK WAY, CUPERTINO, CALIFORNIA 95014
UNITED STATES
- [74] CLT PATENT & TRADEMARK (H.K.) LIMITED
Unit 09, 34/F., Office Tower, Convention Plaza
No. 1 Harbour Road, Wanchai
HONG KONG



-
- [11] 1914351.0M003
- [15] 01-08-2019
- [30] 01-02-2019 / US / 29/679,108
- [51] Cl. 14-04
- [54] 用於電子裝置螢幕顯示的三維人物
Three dimensional character for electronic device screen display
- [73] 蘋果公司
APPLE INC.
ONE APPLE PARK WAY, CUPERTINO, CALIFORNIA 95014
UNITED STATES
- [74] CLT PATENT & TRADEMARK (H.K.) LIMITED
Unit 09, 34/F., Office Tower, Convention Plaza
No. 1 Harbour Road, Wanchai
HONG KONG



[11] 1914351.0M004

[15] 01-08-2019

[30] 01-02-2019 / US / 29/679,108

[51] Cl. 14-04

[54] 用於電子裝置螢幕顯示的三維人物

Three dimensional character for electronic device screen display

[73] 蘋果公司

APPLE INC.

ONE APPLE PARK WAY, CUPERTINO, CALIFORNIA 95014

UNITED STATES

[74] CLT PATENT & TRADEMARK (H.K.) LIMITED

Unit 09, 34/F., Office Tower, Convention Plaza

No. 1 Harbour Road, Wanchai

HONG KONG



[11] 1914372.4

[15] 02-08-2019

[51] Cl. 21-01

[54] 玩具手槍滑架

Toy gun slide

[73] 潘永鴻

Poon Wing Hung, Andrew

7D Paul Yee Mansion,

346 Jaffe Road, Wanchai,
HONG KONG

- [74] HONG KONG INTELLECTUAL PROPERTY AGENT LIMITED
Unit 230, 2/F, Building 12W, No. 12 Science Park West Avenue,
Phase 3, Hong Kong Science Park, Pak Shek Kok, N.T.,
HONG KONG

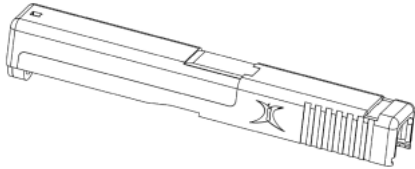

[11] 1914482.7M001

[15] 20-08-2019

[30] 26-02-2019 / US / 29/681,497

[51] Cl. 8-08

[54] 安裝板
Mounting plate

[73] 凱特爾塑膠有限公司
KETER PLASTIC LTD.
1 Sapir Street, 14th Floor Industrial Zone 4685205 Herzliya
ISRAEL

米沃奇電動工具公司
MILWAUKEE ELECTRIC TOOL CORPORATION
13135 West Lisbon Road Brookfield, WI 53005
UNITED STATES

[74] HK PAT IP LIMITED
Flat C, 10/F., Wing Tat Commercial Building
121-125 Wing Lok Street, Sheung Wan
HONG KONG

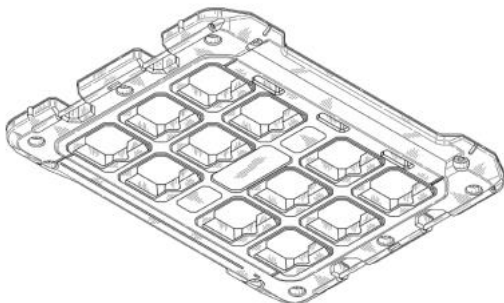

[11] 1914482.7M002

[15] 20-08-2019

[30] 26-02-2019 / US / 29/681,497

[51] Cl. 8-08

[54] 安裝板

Mounting plate

[73] 凱特爾塑膠有限公司

KETER PLASTIC LTD.

1 Sapir Street, 14th Floor Industrial Zone 4685205 Herzliya
ISRAEL

米沃奇電動工具公司

MILWAUKEE ELECTRIC TOOL CORPORATION

13135 West Lisbon Road Brookfield, WI 53005
UNITED STATES

[74] HK PAT IP LIMITED

Flat C, 10/F., Wing Tat Commercial Building

121-125 Wing Lok Street, Sheung Wan

HONG KONG

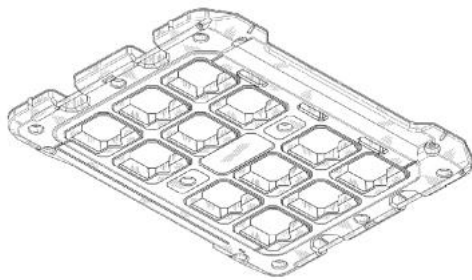

[11] 1914803.0

[15] 11-10-2019

[30] 12-04-2019 / EU / 006376372-0001

[51] Cl. 9-01

[54] 香水瓶

Perfume bottle

[73] LVMH FRAGRANCE BRANDS

77 Rue Anatole France

92300 LEVALLOIS PERRET

FRANCE

[74] WENPING & CO

1701 Tung Wai Commercial Building,

111 Gloucester Road,

HONG KONG

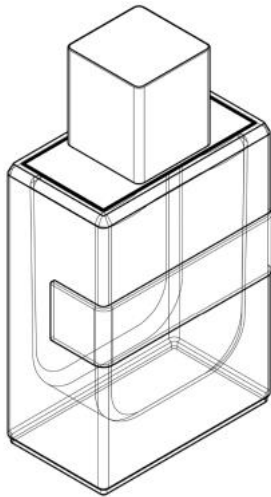

[11] 1914824.4

[15] 15-10-2019

[51] Cl. 24-02

[54] 量子圓錐形穴位按摩器

Quantum circular cone acupoint device

[73] 黃振維

Wong Chun Wai

香港九龍長沙灣道 118 號

長沙大廈 10 樓 A

[74] 黃振維

香港九龍長沙灣道 118 號

長沙大廈 10 樓 A

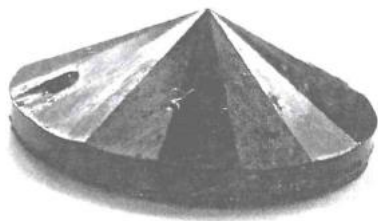

[11] 1914834.5

[15] 17-10-2019

[51] Cl. 19-01

[54] 航空保安封套

Aviation security envelope

[73] 富友倉庫物流有限公司
FU YO WAREHOUSE LOGISTICS COMPANY LIMITED
香港
新界葵涌貨櫃碼頭南路 18 號
葵涌四號貨櫃碼頭和黃物流中心商業大樓 901-902 室

[74] 恒大律師行香港有限公司
香港
中環皇后大道中 70 號
卡佛大廈 1104 室

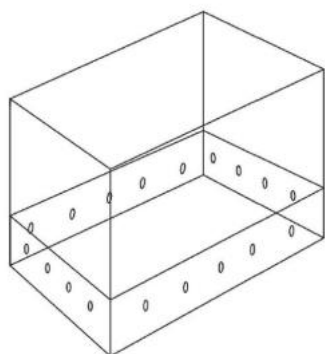

[11] 1914846.1

[15] 21-10-2019

[51] Cl. 3-01

[54] 鯊魚形背包
Shark shaped bag

[73] Morn Creations Limited
2/F, No.254 Tung Choi Street'
Prince Edward,
Kowloon, Hong Kong

[74] Morn Creations Limited
2/F, No.254 Tung Choi Street,
Prince Edward,
Kowloon, Hong Kong



[11] 1914866.3

[15] 24-10-2019

[51] Cl. 13-02

[54] 移動電源連充電底座

Power Bank with charging dock

[73] 創品科技有限公司

Inno3C Limited

香港九龍

觀塘鴻圖路 41 號

華鴻工貿中心 8 樓 1 室

[74] 創品科技有限公司

香港九龍

觀塘鴻圖路 41 號

華鴻工貿中心 8 樓 1 室



[11] 1914868.7

[15] 24-10-2019

[51] Cl. 14-01

[54] 帶有充電盒的藍牙耳機

Bluetooth earphone with charging case

[73] BOOMPODS (HK) LTD.
ROOM 303-304 HANKOW CENTRE
5-15 HANKOW ROAD, T.S.T.
KOWLOON, HONG KONG

[74] BOOMPODS (HK) LTD.
ROOM 303-304 HANKOW CENTRE
5-15 HANKOW ROAD, T.S.T.
KOWLOON, HONG KONG



[11] 1914903.2

[15] 30-10-2019

[51] Cl. 10-02

[54] 機芯可翻轉的雙機芯三針時分秒顯示腕錶

Turnable head dual time wrist watch with two automatic movements

[73] MAZZUCATO SIMONE SERGIO

Flat G, 21/F, Reason Group Tower, 403 Castle Peak Road, Kwai Chung, N.T., HONG KONG

[74] MAZZUCATO DESIGN LTD.

Flat G, 21/F, Reason Group Tower, 403 Castle Peak Road, Kwai Chung, N.T., HONG KONG



-
- [11] 1914954.9
[15] 06-11-2019
[51] Cl. 26-05
[54] 應急燈
Emergency lamp
[73] KWOK SIU CHUEN
香港鯰魚涌
康柏徑 10 號
A 座 4 樓 1 室
[74] KWOK SIU CHUEN
香港鯰魚涌
康柏徑 10 號
A 座 4 樓 1 室

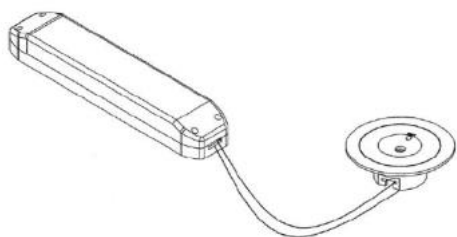

-
- [11] 1914960.2
[15] 06-11-2019
[51] Cl. 9-03
[54] 包裝盒
Packing box
[73] 美基保健有限公司
M & Join Trading Co. Ltd.

香港新界火炭
拗背灣街 45-47 號
喜利佳工業大廈 9 樓 T 室

[74] 陳穎琪

香港新界火炭
拗背灣街 45-47 號
喜利佳工業大廈 9 樓 T 室



[11] 1914986.7

[15] 08-11-2019

[51] Cl. 9-01

[54] 瓶
Bottle

[73] 天大實業(中國)有限公司
Tianda (CHINA) Limited
中國內地
深圳市羅湖區人民南路
天安國際大廈 C 座 28 樓

[74] 薛舉萍
香港
中環添美道 1 號
中信大廈 24 樓



[11] 1914996.8

[15] 11-11-2019

[30] 13-06-2019 / CN / 201930305209.2

[51] C1. 7-05

[54] 洗衣凝珠

Laundry bead

[73] 威萊（香港）有限公司

WHEALTHFIELDS (HONG KONG) LIMITED

香港

香港新界沙田安耀街 3 號

匯達大廈 2606-10

[74] 精英知識產權服務有限公司

香港

九龍彌敦道 695 號

永如大廈 12 字樓

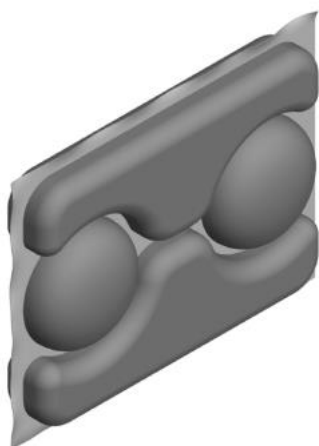

- [11] 1914998.2
[15] 11-11-2019
[30] 12-05-2019 / US / 29/690,872
[51] Cl. 9-07
[54] 油的分配器
Oil dispenser
[73] Helen of Troy Limited
The Phoenix Centre
George Street, Belleville, St. Michael
BARBADOS
[74] Bird & Bird
6/F, The Annex, Central Plaza
18 Harbour Road
Hong Kong



-
- [11] 1915038.8M001
[15] 19-11-2019
[51] Cl. 14-06
[54] 寵物形狀手機支架
Pet shaped mobile phone holder
[73] 許宏業
Hui Wang Yip, Patrick
Room 2A02, Cheung Wah Industrial Building
10-12 Shipyard Lane, Quarry Bay
HONG KONG
[74] Hui Wang Yip, Patrick
Room 2A02, Cheung Wah Industrial Building
10-12 Shipyard Lane, Quarry Bay
HONG KONG

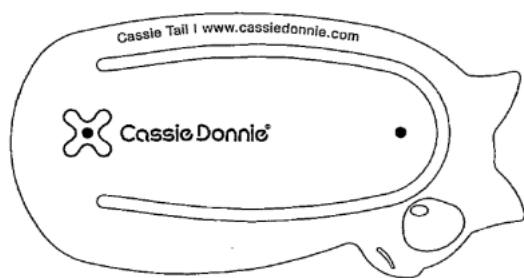

[11] 1915038.8M002

[15] 19-11-2019

[51] Cl. 14-06

[54] 寵物形狀手機支架

Pet shaped mobile phone holder

[73] 許宏業

Hui Wang Yip, Patrick

Room 2A02, Cheung Wah Industrial Building

10-12 Shipyard Lane, Quarry Bay

HONG KONG

[74] Hui Wang Yip, Patrick

Room 2A02, Cheung Wah Industrial Building

10-12 Shipyard Lane, Quarry Bay

HONG KONG



[11] 1915048.9

[15] 20-11-2019

[30] 21-05-2019 / JP / 011002 of 2019

[51] Cl. 23-03

[54] 濕紙巾加熱器

Wet tissue heater

[73] 康貝株式會社

Combi Corporation

6-7, Motoasakusa 2-chome

Taito-ku, Tokyo 111-0041

JAPAN

[74] WILKINSON & GRIST

6th Floor, Prince's Building

Chater Road

HONG KONG



[11] 1915049.1

[15] 20-11-2019

[30] 30-05-2019 / JP / 011778 of 2019

[51] Cl. 12-12

[54] 帶扶手的助行器

Walker with flat handrail

[73] 松下知識產權經營株式會社

Panasonic Intellectual Property Management Co., Ltd.

1-61, Shiromi 2-chome, Chuo-ku

Osaka-shi, Osaka 540-6207

JAPAN

[74] MARKS & CLERK

Level 9, Cyberport 1

100 Cyberport Road, Pok Fu Lam

HONG KONG

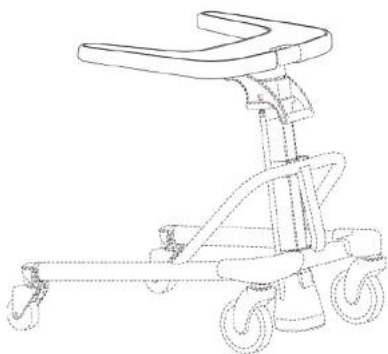

[11] 1915057.8

[15] 22-11-2019

[30] 22-05-2019 / SG, CH, GB, EU / DM/203 262

[51] Cl. 11-01

[54] 具多個裝飾元件的首飾

Jewelry having multiple decorative elements

[73] VAN CLEEF & ARPELS SA

Route des Biches 8

1752 Villars-sur-Glâne

SWITZERLAND

[74] WENPING PATENT & TRADE MARK AGENT LIMITED

1701 Tung Wai Commercial Building,

111 Gloucester Road,

HONG KONG



[11] 1915114.9

[15] 28-11-2019

[51] Cl. 11-02

[54] 裝飾品

Ornamental object

[73] 佳輝新創有限公司

SMART CREATIONS COMPANY LIMITED
FLAT/ RM 1906, 19/F, NAN FUNG CENTRE,
298 CASTLE PEAK ROAD, TSUEN WAN, NT,
HONG KONG

[74] REG EASY INTELLECTUAL PROPERTY CO., LIMITED

14/F, China Hong Kong Tower
8 Hennessy Road, Wan Chai
HONG KONG

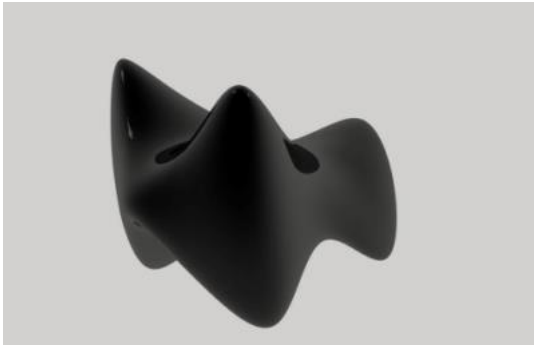

[11] 1915130.3M001

[15] 29-11-2019

[30] 07-11-2019 / CN / 201930611282.2

[51] Cl. 13-03

[54] 多功能轉換器

Multifunctional adaptor

[73] 廣東高普達集團股份有限公司

GUANGDONG GOPOD GROUP CO., LTD.

中國內地

廣東省深圳市龍華新區大浪街道同勝社區華榮路聯建科技工業園廠房 8 棟 4, 5, 6 樓

[74] 中一聯合國際知識產權有限公司

香港九龍尖沙咀

漆咸道南 45-51 號

其士大廈 803 室

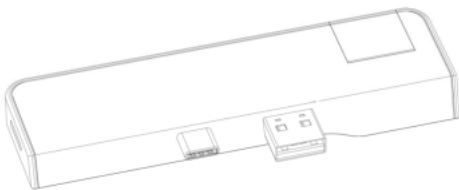

[11] 1915130.3M002

[15] 29-11-2019

[51] Cl. 13-03

[54] 多功能轉換器

Multifunctional adaptor

[73] 廣東高普達集團股份有限公司

GUANGDONG GOPOD GROUP CO., LTD.

中國內地

廣東省深圳市龍華新區大浪街道同勝社區華榮路聯建科技工業園廠房 8 棟 4, 5, 6 樓

[74] 中一聯合國際知識產權有限公司

香港九龍尖沙咀

漆咸道南 45-51 號

其士大廈 803 室

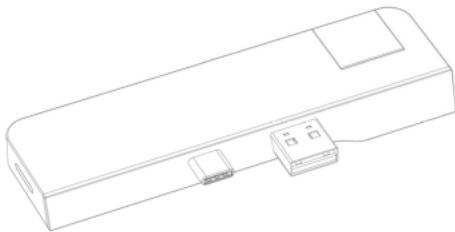

[11] 1915144.2M001

[15] 29-11-2019

[30] 01-06-2019 / US / 29/693,365

[51] Cl. 14-04

[54] 用於顯示屏或其一部分的圖形用戶界面

Graphical user interface for display screen or portion thereof

[73] 蘋果公司

APPLE INC.

ONE APPLE PARK WAY

CUPERTINO, CALIFORNIA 95014

UNITED STATES

[74] CLT PATENT & TRADEMARK (H.K.) LIMITED

Unit 09, 34/F., Office Tower, Convention Plaza

No. 1 Harbour Road, Wanchai

HONG KONG

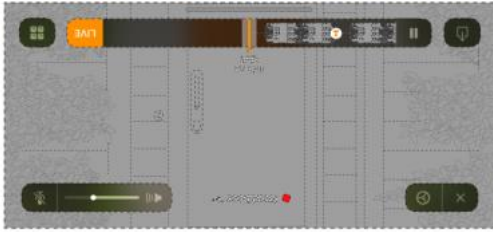

[11] 1915144.2M002

[15] 29-11-2019

[30] 01-06-2019 / US / 29/693,365

[51] Cl. 14-04

[54] 用於顯示屏或其一部分的圖形用戶界面

Graphical user interface for display screen or portion thereof

[73] 蘋果公司

APPLE INC.

ONE APPLE PARK WAY

CUPERTINO, CALIFORNIA 95014

UNITED STATES

[74] CLT PATENT & TRADEMARK (H.K.) LIMITED

Unit 09, 34/F., Office Tower, Convention Plaza

No. 1 Harbour Road, Wanchai

HONG KONG

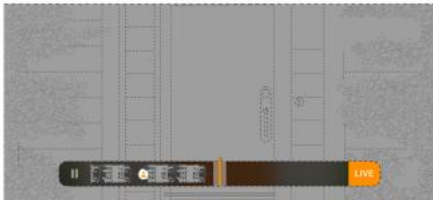

[11] 1915144.2M003

[15] 29-11-2019

[30] 01-06-2019 / US / 29/693,365

[51] Cl. 14-04

[54] 用於顯示屏或其一部分的圖形用戶界面

Graphical user interface for display screen or portion thereof

[73] 蘋果公司

APPLE INC.

ONE APPLE PARK WAY

CUPERTINO, CALIFORNIA 95014

UNITED STATES

[74] CLT PATENT & TRADEMARK (H.K.) LIMITED
Unit 09, 34/F., Office Tower, Convention Plaza
No. 1 Harbour Road, Wanchai
HONG KONG

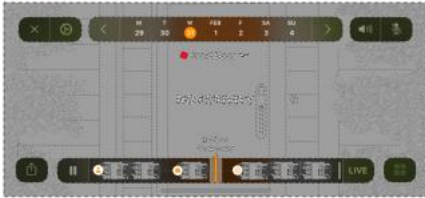

[11] 1915144.2M004

[15] 29-11-2019

[30] 01-06-2019 / US / 29/693,365

[51] Cl. 14-04

[54] 用於顯示屏或其一部分的圖形用戶界面
Graphical user interface for display screen or portion thereof

[73] 蘋果公司
APPLE INC.
ONE APPLE PARK WAY
CUPERTINO, CALIFORNIA 95014
UNITED STATES

[74] CLT PATENT & TRADEMARK (H.K.) LIMITED
Unit 09, 34/F., Office Tower, Convention Plaza
No. 1 Harbour Road, Wanchai
HONG KONG



- [11] 1915144.2M005
- [15] 29-11-2019
- [30] 01-06-2019 / US / 29/693,365
- [51] Cl. 14-04
- [54] 用於顯示屏或其一部分的圖形用戶界面
Graphical user interface for display screen or portion thereof
- [73] 蘋果公司
APPLE INC.
ONE APPLE PARK WAY
CUPERTINO, CALIFORNIA 95014
UNITED STATES
- [74] CLT PATENT & TRADEMARK (H.K.) LIMITED
Unit 09, 34/F., Office Tower, Convention Plaza
No. 1 Harbour Road, Wanchai
HONG KONG

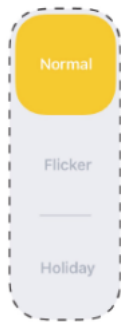

-
- [11] 1915144.2M006
- [15] 29-11-2019
- [30] 01-06-2019 / US / 29/693,365
- [51] Cl. 14-04
- [54] 用於顯示屏或其一部分的圖形用戶界面
Graphical user interface for display screen or portion thereof
- [73] 蘋果公司
APPLE INC.
ONE APPLE PARK WAY
CUPERTINO, CALIFORNIA 95014
UNITED STATES
- [74] CLT PATENT & TRADEMARK (H.K.) LIMITED
Unit 09, 34/F., Office Tower, Convention Plaza

No. 1 Harbour Road, Wanchai
HONG KONG

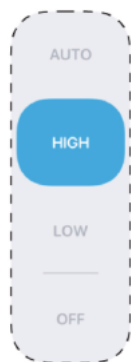

[11] 1915144.2M007

[15] 29-11-2019

[30] 01-06-2019 / US / 29/693,365

[51] Cl. 14-04

[54] 用於顯示屏或其一部分的圖形用戶界面

Graphical user interface for display screen or portion thereof

[73] 蘋果公司

APPLE INC.

ONE APPLE PARK WAY

CUPERTINO, CALIFORNIA 95014

UNITED STATES

[74] CLT PATENT & TRADEMARK (H.K.) LIMITED

Unit 09, 34/F., Office Tower, Convention Plaza

No. 1 Harbour Road, Wanchai

HONG KONG



[11] 1915144.2M008

[15] 29-11-2019

[30] 01-06-2019 / US / 29/693,365

[51] Cl. 14-04

[54] 用於顯示屏或其一部分的圖形用戶界面

Graphical user interface for display screen or portion thereof

[73] 蘋果公司

APPLE INC.

ONE APPLE PARK WAY

CUPERTINO, CALIFORNIA 95014

UNITED STATES

[74] CLT PATENT & TRADEMARK (H.K.) LIMITED

Unit 09, 34/F., Office Tower, Convention Plaza

No. 1 Harbour Road, Wanchai

HONG KONG

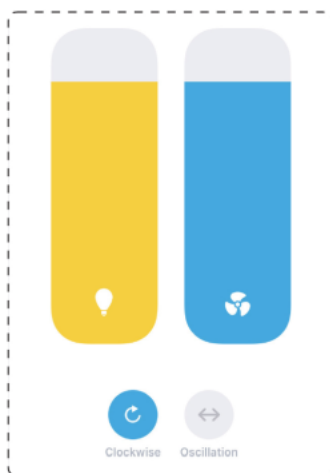

[11] 1915194.7

[15] 05-12-2019

[30] 12-06-2019 / KR / 30-2019-0027820

[51] Cl. 24-02

[54] 耳針灸針

Ear acupuncture needle

[73] Seiga Inc.

Room E-2, 1F, 8-7, Yuseong-daero 1689beon-gil, Yuseong-gu,

Daejeon, 34046

Korea, Republic of

[74] Chinahongkong Ip Limited

3011, 30/F, Office Tower,

Convention Plaza, 1 Harbour Road,
Hong Kong

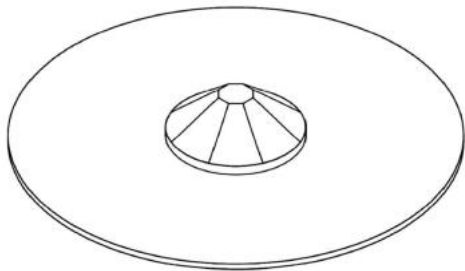

[11] 1915346.1M001

[15] 31-12-2019

[51] Cl. 21-01

[54] 積木形遊戲機

Brick shaped game machine

[73] 日順科企有限公司

SOLAR TUNE ENTERPRISE LTD

香港

九龍青山道 489-491 號

香港工業中心 C 座 2 樓 4A 室

[74] 日順科企有限公司

香港

九龍青山道 489-491 號

香港工業中心 C 座 2 樓 4A 室

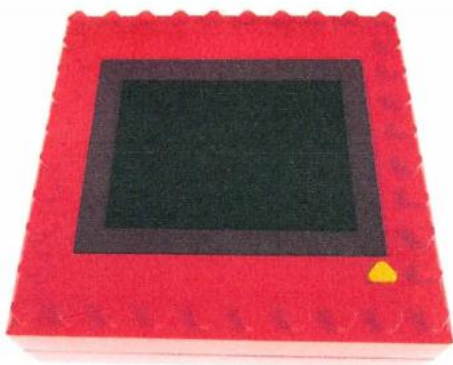

[11] 1915346.1M002

[15] 31-12-2019

[51] Cl. 21-01

[54] 遊戲機控制器

Controller of game machine

[73] 日順科企有限公司
SOLAR TUNE ENTERPRISE LTD
香港
九龍青山道 489-491 號
香港工業中心 C 座 2 樓 4A 室

[74] 日順科企有限公司
香港
九龍青山道 489-491 號
香港工業中心 C 座 2 樓 4A 室



[11] 2015400.9M001

[15] 10-01-2020

[30] 14-08-2019 / CA, AM, AZ, BZ, BA, GE, LI, MK, MD, MC, MN, ME,
NO, OM, RU, SG, CH, TN, TR, UA, GB, EU, AL, KG / DM/203 250

[51] Cl. 11-01

[54] 耳環
Earring

[73] Harry Winston SA
Chemin du Tourbillon 8,
CH-1228 Plan-les-Ouates,
Switzerland

[74] SPRUSON & FERGUSON (HONG KONG) LIMITED
5001 Hopewell Centre,
183 Queen's Road East,
Wan Chai, Hong Kong



[11] 2015400.9M002

[15] 10-01-2020

[30] 14-08-2019 / CA, AM, AZ, BZ, BA, GE, LI, MK, MD, MC, MN, ME, NO, OM, RU, SG, CH, TN, TR, UA, GB, EU, AL, KG / DM/203 250

[51] Cl. 11-01

[54] 項鍊

Necklace

[73] Harry Winston SA
Chemin du Tourbillon 8,
CH-1228 Plan-les-Ouates,
Switzerland

[74] SPRUSON & FERGUSON (HONG KONG) LIMITED
5001 Hopewell Centre,
183 Queen's Road East,
Wan Chai, Hong Kong



- [11] 2015400.9M003
- [15] 10-01-2020
- [30] 14-08-2019 / CA, AM, AZ, BZ, BA, GE, LI, MK, MD, MC, MN, ME, NO, OM, RU, SG, CH, TN, TR, UA, GB, EU, AL, KG / DM/203 250
- [51] Cl. 11-01
- [54] 指環
Ring
- [73] Harry Winston SA
Chemin du Tourbillon 8,
CH-1228 Plan-les-Ouates,
Switzerland
- [74] SPRUSON & FERGUSON (HONG KONG) LIMITED
5001 Hopewell Centre,
183 Queen's Road East,
Wan Chai, Hong Kong



-
- [11] 2015400.9M004
- [15] 10-01-2020
- [30] 14-08-2019 / CA, AM, AZ, BZ, BA, GE, LI, MK, MD, MC, MN, ME, NO, OM, RU, SG, CH, TN, TR, UA, GB, EU, AL, KG / DM/203 250
- [51] Cl. 11-01
- [54] 耳環
Earring
- [73] Harry Winston SA
Chemin du Tourbillon 8,
CH-1228 Plan-les-Ouates,
Switzerland
- [74] SPRUSON & FERGUSON (HONG KONG) LIMITED
5001 Hopewell Centre,
183 Queen's Road East,
Wan Chai, Hong Kong



[11] 2015401.1

[15] 10-01-2020

[30] 21-11-2019 / CN / 201930642094.6

[51] Cl. 11-01

[54] 飛碟形貴金屬耳扣

Saucer-shaped precious metal earnuts

[73] 廣州市天豐珠寶有限公司

Guangzhou TinFung Jewelry Limited

中國內地

廣州市番禺區

沙頭街銀建路 34 號二樓

[74] RIGHT IP LIMITED

香港

木星街 9 號

永昇中心 2002

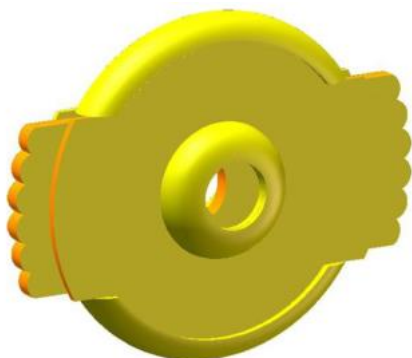

[11] 2015403.5

- [15] 10-01-2020
- [30] 21-11-2019 / CN / 201930642092.7
- [51] Cl. 11-01
- [54] 空心工字扣鑲嵌寶石珠仔鏈
Gem bead chain inlay with hollow button
- [73] 廣州市天豐珠寶有限公司
Guangzhou TinFung Jewelry Limited
中國內地
廣州市番禺區
沙頭街銀建路 34 號二樓
- [74] RIGHT IP LIMITED
香港
木星街 9 號
永昇中心 2002



-
- [11] 2015404.7M001
- [15] 10-01-2020
- [30] 29-11-2019 / MC, MA, SG, CH, TN, TR, UA, EU, JP, KR /
WIPO89891
- [51] Cl. 11-01
- [54] 項鍊
Necklace
- [73] 查梅特國際有限公司
CHAUMET INTERNATIONAL S.A.
12 Place Vendôme,
75001 Paris,
France
- [74] BARRON & YOUNG INTELLECTUAL PROPERTY LIMITED
Suite 617, Lakeside 2,
No. 10 Science Park West Avenue,
Hong Kong Science Park, Shatin, N.T.,
Hong Kong



[11] 2015404.7M002

[15] 10-01-2020

[30] 29-11-2019 / MC, MA, SG, CH, TN, TR, UA, EU, JP, KR /
WIPO89891

[51] Cl. 11-01

[54] 項鍊
Necklace

[73] 查梅特國際有限公司
CHAUMET INTERNATIONAL S.A.
12 Place Vendôme,
75001 Paris,
France

[74] BARRON & YOUNG INTELLECTUAL PROPERTY LIMITED
Suite 617, Lakeside 2,
No. 10 Science Park West Avenue,
Hong Kong Science Park, Shatin, N.T.,
Hong Kong



- [11] 2015404.7M003
[15] 10-01-2020
[30] 29-11-2019 / MC, MA, SG, CH, TN, TR, UA, EU, JP, KR /
WIPO89891
[51] Cl. 11-01
[54] 吊墜
Pendant
[73] 查梅特國際有限公司
CHAUMET INTERNATIONAL S.A.
12 Place Vendôme,
75001 Paris,
France
[74] BARRON & YOUNG INTELLECTUAL PROPERTY LIMITED
Suite 617, Lakeside 2,
No. 10 Science Park West Avenue,
Hong Kong Science Park, Shatin, N.T.,
Hong Kong



-
- [11] 2015404.7M004
[15] 10-01-2020
[30] 29-11-2019 / MC, MA, SG, CH, TN, TR, UA, EU, JP, KR /
WIPO89891
[51] Cl. 11-01
[54] 戒指
Ring
[73] 查梅特國際有限公司
CHAUMET INTERNATIONAL S.A.
12 Place Vendôme,

75001 Paris,
France

[74] BARRON & YOUNG INTELLECTUAL PROPERTY LIMITED
Suite 617, Lakeside 2,
No. 10 Science Park West Avenue,
Hong Kong Science Park, Shatin, N.T.,
Hong Kong



[11] 2015404.7M005

[15] 10-01-2020

[30] 29-11-2019 / MC, MA, SG, CH, TN, TR, UA, EU, JP, KR /
WIPO89891

[51] Cl. 11-01

[54] 耳環
Earring

[73] 查梅特國際有限公司
CHAUMET INTERNATIONAL S.A.
12 Place Vendôme,
75001 Paris,
France

[74] BARRON & YOUNG INTELLECTUAL PROPERTY LIMITED
Suite 617, Lakeside 2,
No. 10 Science Park West Avenue,
Hong Kong Science Park, Shatin, N.T.,
Hong Kong



[11] 2015406.2

[15] 13-01-2020

[51] Cl. 4-02

[54] 牙刷

Toothbrush

[73] 好維股份有限公司

Hawley & Hazel (BVI) Co. Ltd.
Trident Chambers, P. O. Box 146,
Road Town, Tortola,
Virgin Islands (British)

[74] BAKER & MCKENZIE

14th Floor, One Taikoo Place,
979 King's Road, Quarry Bay,
Hong Kong



[11] 2015407.4

[15] 13-01-2020

[51] Cl. 4-02

[54] 牙刷

Toothbrush

[73] 好維股份有限公司

Hawley & Hazel (BVI) Co. Ltd.

Trident Chambers, P. O. Box 146,

Road Town, Tortola,

Virgin Islands (British)

[74] BAKER & MCKENZIE

14th Floor, One Taikoo Place,

979 King's Road, Quarry Bay,

Hong Kong



[11] 2015409.8M001

[15] 14-01-2020

[51] Cl. 19-06

[54] 書法鋼筆及筆帽

Calligraphy fountain pen with cap

[73] 施耐德書寫工具有限公司

Schneider Schreibgeräte GmbH

Schwarzenbach 9,

78144 Schramberg,

Germany

[74] WILKINSON & GRIST

6th Floor, Prince's Building,

Chater Road,

Hong Kong

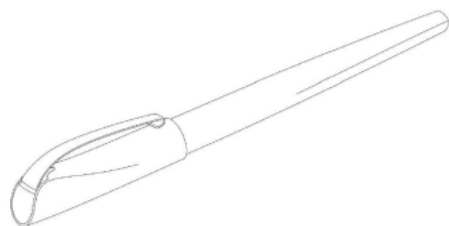

[11] 2015409.8M002

[15] 14-01-2020

[51] Cl. 19-06

[54] 書法鋼筆

Calligraphy fountain pen

[73] 施耐德書寫工具有限公司

Schneider Schreibgeräte GmbH

Schwarzenbach 9,

78144 Schramberg,

Germany

[74] WILKINSON & GRIST

6th Floor, Prince's Building,

Chater Road,

Hong Kong

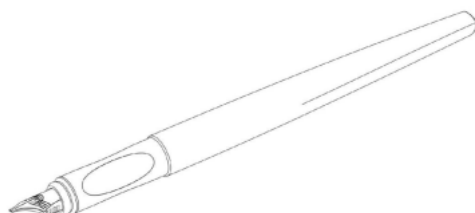

[11] 2015409.8M003

[15] 14-01-2020

[51] Cl. 19-06

[54] 書法鋼筆帽

Cap for calligraphy fountain pen

[73] 施耐德書寫工具有限公司

Schneider Schreibgeräte GmbH

Schwarzenbach 9,

78144 Schramberg,

Germany

[74] WILKINSON & GRIST

6th Floor, Prince's Building,

Chater Road,
Hong Kong

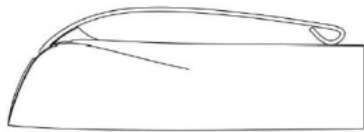

[11] 2015411.2

[15] 14-01-2020

[30] 29-07-2019 / US / 29/699,793

[51] Cl. 9-05

[54] 包裝

Packaging

[73] 裡珍納龍藥品有限公司

Regeneron Pharmaceuticals, Inc.

777 Old Saw Mill River Road Tarrytown,

NY 10591,

United States

[74] MINTERELLISON LLP

Level 32, Wu Chung House,

213 Queen's Road East,

Hong Kong

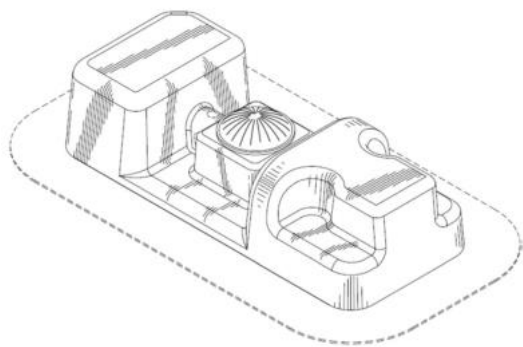

[11] 2015412.4M001

[15] 15-01-2020

[51] Cl. 11-01

[54] 飾物設計

Ornament design

[73] 六福集團有限公司

Luk Fook Holdings Company Limited
Floor 15, 20, 25 27, Metropole Square,
No.2 On Yiu Street, Shatin,
New Territories, Hong Kong, China

[74] Luk Fook Holdings Company Limited (Legal Affairs Department)

Floor 25, Metropole Square,
No.2 On Yiu Street,
Shatin, New Territories, Hong Kong



[11] 2015412.4M002

[15] 15-01-2020

[51] Cl. 11-01

[54] 飾物設計

Ornament design

[73] 六福集團有限公司

Luk Fook Holdings Company Limited
Floor 15, 20, 25 27, Metropole Square,
No.2 On Yiu Street, Shatin,
New Territories, Hong Kong, China

[74] Luk Fook Holdings Company Limited (Legal Affairs Department)

Floor 25, Metropole Square,
No.2 On Yiu Street,
Shatin, New Territories, Hong Kong



[11] 2015412.4M003

[15] 15-01-2020

[51] Cl. 11-01

[54] 飾物設計

Ornament design

[73] 六福集團有限公司

Luk Fook Holdings Company Limited
Floor 15, 20, 25 27, Metropole Square,
No.2 On Yiu Street, Shatin,
New Territories, Hong Kong, China

[74] Luk Fook Holdings Company Limited (Legal Affairs Department)

Floor 25, Metropole Square,
No.2 On Yiu Street,
Shatin, New Territories, Hong Kong



[11] 2015412.4M004

[15] 15-01-2020

[51] Cl. 11-01

[54] 飾物設計

Ornament design

[73] 六福集團有限公司

Luk Fook Holdings Company Limited
Floor 15, 20, 25 27, Metropole Square,
No.2 On Yiu Street, Shatin,
New Territories, Hong Kong, China

[74] Luk Fook Holdings Company Limited (Legal Affairs Department)

Floor 25, Metropole Square,
No.2 On Yiu Street,
Shatin, New Territories, Hong Kong



[11] 2015412.4M005

[15] 15-01-2020

[51] Cl. 11-01

[54] 飾物設計

Ornament design

[73] 六福集團有限公司

Luk Fook Holdings Company Limited
Floor 15, 20, 25 27, Metropole Square,
No.2 On Yiu Street, Shatin,
New Territories, Hong Kong, China

[74] Luk Fook Holdings Company Limited (Legal Affairs Department)

Floor 25, Metropole Square,
No.2 On Yiu Street,
Shatin, New Territories, Hong Kong



[11] 2015413.6

[15] 15-01-2020

[51] Cl. 7-07

[54] 可折疊容器

Foldable container

[73] Plastmetic (Hong Kong) Manufactory Limited

Unit 12, 18/F., Rear Block,
Wah Fat Industrial Building,
10-14 Kung Yip Street,
Kwai Chung, New Territories, Hong Kong

[74] CHAN, TANG & KWOK

Rooms 2503-04, 25/F.,
Shanghai Industrial Investment Building,
48-62 Hennessy Road,
Wanchai, Hong Kong

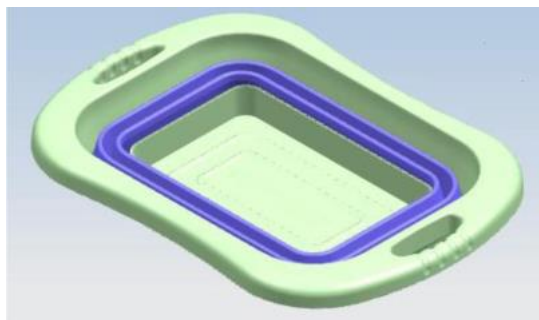

[11] 2015414.8

[15] 15-01-2020

[51] Cl. 7-07

[54] 可折疊容器

Foldable container

[73] Plastmetic (Hong Kong) Manufactory Limited

Unit 12, 18/F., Rear Block,

Wah Fat Industrial Building,

10-14 Kung Yip Street,

Kwai Chung, New Territories, Hong Kong

[74] CHAN, TANG & KWOK

Rooms 2503-04, 25/F.,

Shanghai Industrial Investment Building,

48-62 Hennessy Road,

Wanchai, Hong Kong

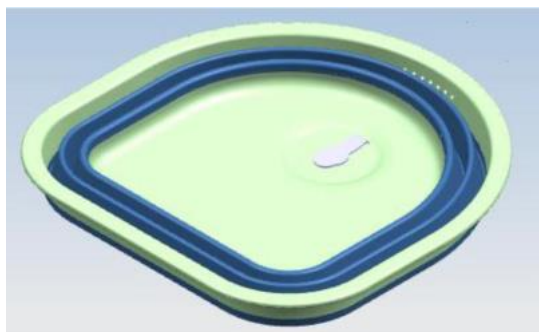

[11] 2015415.1

[15] 15-01-2020

[51] Cl. 7-07

[54] 可折疊容器

Foldable container

[73] Plastmetic (Hong Kong) Manufactory Limited

Unit 12, 18/F., Rear Block,

Wah Fat Industrial Building,

10-14 Kung Yip Street,
Kwai Chung, New Territories, Hong Kong

- [74] CHAN, TANG & KWOK
Rooms 2503-04, 25/F.,
Shanghai Industrial Investment Building,
48-62 Hennessy Road,
Wanchai, Hong Kong

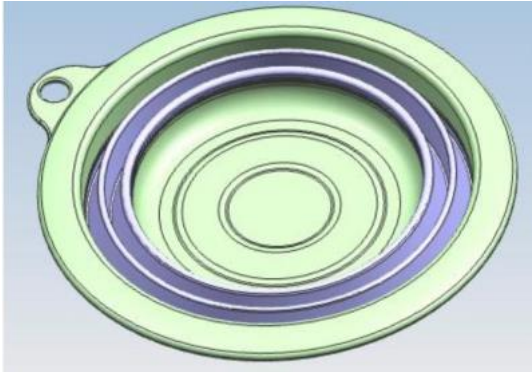

-
- [11] 2015416.3
[15] 15-01-2020
[51] Cl. 9-03
[54] 可折疊容器
Foldable container
[73] Plastmetic (Hong Kong) Manufactory Limited
Unit 12, 18/F., Rear Block,
Wah Fat Industrial Building,
10-14 Kung Yip Street,
Kwai Chung, New Territories, Hong Kong
[74] CHAN, TANG & KWOK
Rooms 2503-04, 25/F.,
Shanghai Industrial Investment Building,
48-62 Hennessy Road,
Wanchai, Hong Kong

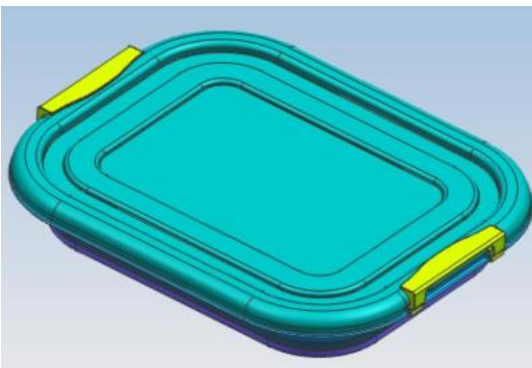

[11] 2015417.5

[15] 15-01-2020

[51] Cl. 31-00

[54] 酒精飲料分配器
Alcoholic beverages dispenser

[73] 梁偉倫
LEUNG, WAI LUN
Unit 412, Hope Sea Industrial Centre.,
26 Lam Hing Street,
Kowloon Bay, Hong Kong

[74] IPMS CONSULTANTS LIMITED
Unit 2004B, 20/F, Tower 5,
China Hong Kong City,
33 Canton Road,
Tsim Sha Tsui, Kowloon, Hong Kong

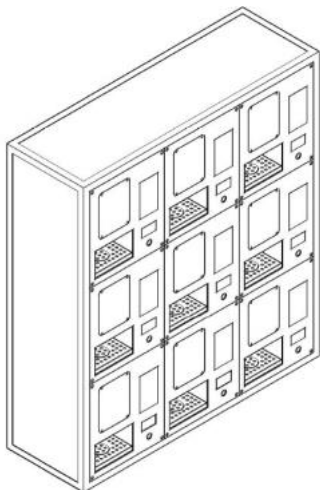

[11] 2015422.5M001

[15] 16-01-2020

[30] 08-10-2019 / CN / 201930545585.9

[51] Cl. 14-03

[54] 手機
Mobile phone

[73] 北京小米移動軟件有限公司
Beijing Xiaomi Mobile Software Co., Ltd.
中國內地北京市
海澱區西二旗中路 33 號院
6 號樓 8 層 018 號

[74] 隆天專利商標代理有限公司
香港長沙灣

青山道 485 號
九龍廣場 10 樓 11 室



[11] 2015422.5M002

[15] 16-01-2020

[30] 08-10-2019 / CN / 201930545585.9

[51] Cl. 14-03

[54] 手機

Mobile phone

[73] 北京小米移動軟件有限公司

Beijing Xiaomi Mobile Software Co., Ltd.

中國內地北京市

海澱區西二旗中路 33 號院

6 號樓 8 層 018 號

[74] 隆天專利商標代理有限公司

香港長沙灣

青山道 485 號

九龍廣場 10 樓 11 室



[11] 2015422.5M003

[15] 16-01-2020

[30] 08-10-2019 / CN / 201930545585.9

[51] Cl. 14-03

[54] 手機

Mobile phone

[73] 北京小米移動軟件有限公司

Beijing Xiaomi Mobile Software Co., Ltd.

中國內地北京市

海澱區西二旗中路 33 號院

6 號樓 8 層 018 號

[74] 隆天專利商標代理有限公司

香港長沙灣

青山道 485 號

九龍廣場 10 樓 11 室



[11] 2015423.7M001

[15] 16-01-2020

[30] 15-08-2019 / EU / 006727111

[51] Cl. 7-05

[54] 直立式掛燙機連燙衣板

Stand steamer with ironing board

[73] Koninklijke Philips N.V.

High Tech Campus 5,

5656 AE Eindhoven,

Netherlands

[74] WILKINSON & GRIST

6th Floor, Prince's Building,

Chater Road,

Hong Kong

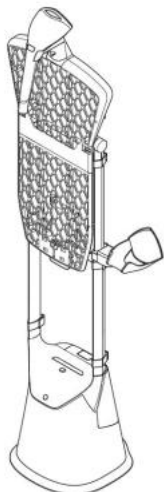

[11] 2015423.7M002

[15] 16-01-2020

[30] 15-08-2019 / EU / 006727111

[51] Cl. 7-05

[54] 直立式掛燙機連燙衣板
Stand steamer with ironing board

[73] Koninklijke Philips N.V.
High Tech Campus 5,
5656 AE Eindhoven,
Netherlands

[74] WILKINSON & GRIST
6th Floor, Prince's Building,
Chater Road,
Hong Kong

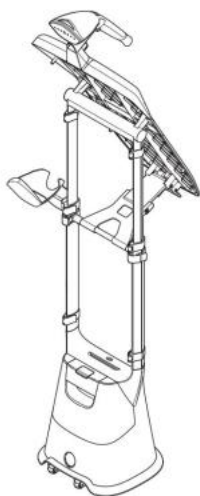

- [11] 2015423.7M003
[15] 16-01-2020
[30] 15-08-2019 / EU / 006727111
[51] Cl. 7-05
[54] 直立式掛燙機的底座
Base for stand steamer
[73] Koninklijke Philips N.V.
High Tech Campus 5,
5656 AE Eindhoven,
Netherlands
[74] WILKINSON & GRIST
6th Floor, Prince's Building,
Chater Road,
Hong Kong



-
- [11] 2015423.7M004
[15] 16-01-2020
[30] 15-08-2019 / EU / 006727111
[51] Cl. 7-05
[54] 直立式掛燙機噴頭
Steamer head for stand steamer
[73] Koninklijke Philips N.V.
High Tech Campus 5,
5656 AE Eindhoven,
Netherlands
[74] WILKINSON & GRIST
6th Floor, Prince's Building,
Chater Road,
Hong Kong

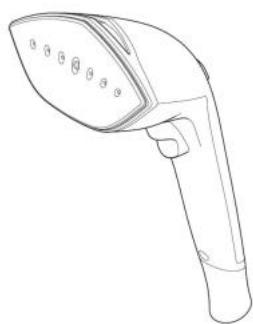

[11] 2015425.2

[15] 05-06-2019

[51] Cl. 11-02

[54] 裝飾杯子

Decorative cup

[73] 老鋪黃金(香港)有限公司

LAO PU (HONG KONG) COMPANY LIMITED

Room 801-2, 8/F,

Easey Commercial Building,

253-261 Hennessy Road,

Wanchai, Hong Kong

[74] SF LAWYERS

Unit 1125-1127, Prince's Building,

10 Chater Road,

Central, Hong Kong



[11] 2015427.6

[15] 16-01-2020

[30] 03-09-2019 / CN / 201930484108.6

[51] Cl. 10-02

[54] 手錶

Watch

[73] 丹尼爾惠靈頓有限公司
Daniel Wellington AB
Vasagatan 12,
111 20 Stockholm,
Sweden

[74] AWA ASIA LIMITED
Suite 1411, 14/F Leighton Centre,
77 Leighton Road,
Causeway Bay, Hong Kong



[11] 2015430.2

[15] 16-01-2020

[51] Cl. 10-02

[54] 手錶
Wrist watch

[73] 優特時尚有限公司
Top Klasse Limited
RM 1705-6, 17/F, President Comm Ctr,
608 Nathan Road,
Mong Kok, Kowloon, Hong Kong

[74] Bird & Bird
6/F, The Annex, Central Plaza
18 Harbour Road
Hong Kong

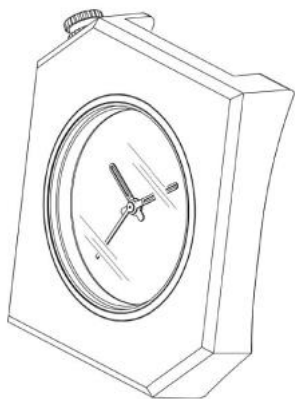

[11] 2015431.4

[15] 17-01-2020

[30] 14-10-2019 / CA, LI, MC, OM, RU, SG, CH, TR, UA, GB, EU, IS,
JP, KR / WIPO88439

[51] Cl. 10-02

[54] 手錶

Watch

[73] Turlen Holding SA

Rue du Jura 11,
2345 Les Breuleux,
Switzerland

[74] WILKINSON & GRIST

6th Floor, Prince's Building,
Chater Road,
Hong Kong



- [11] 2015432.6M001
[15] 17-01-2020
[30] 22-08-2019 / EU / 006754644
[51] Cl. 7-05
[54] 熨斗連蒸汽製造器
Iron with steam generator
[73] Koninklijke Philips N.V.
High Tech Campus 5,
5656 AE Eindhoven,
Netherlands
[74] WILKINSON & GRIST
6th Floor, Prince's Building,
Chater Road,
Hong Kong



-
- [11] 2015432.6M002
[15] 17-01-2020
[30] 22-08-2019 / EU / 006754644
[51] Cl. 7-05
[54] 熨斗的蒸汽製造器
Steam generator for iron
[73] Koninklijke Philips N.V.
High Tech Campus 5,
5656 AE Eindhoven,
Netherlands
[74] WILKINSON & GRIST
6th Floor, Prince's Building,
Chater Road,
Hong Kong



[11] 2015432.6M003

[15] 17-01-2020

[30] 22-08-2019 / EU / 006754644

[51] Cl. 7-05

[54] 蒸汽電熨斗

Electric steam iron

[73] Koninklijke Philips N.V.

High Tech Campus 5,

5656 AE Eindhoven,

Netherlands

[74] WILKINSON & GRIST

6th Floor, Prince's Building,

Chater Road,

Hong Kong



[11] 2015433.8M001

[15] 17-01-2020

[30] 18-07-2019 / US / 29/698,648

[51] Cl. 9-03

[54] 容器

Container

[73] Helen of Troy Limited

The Financial Services Centre,

Bishop's Court Hill Suite 1,

Ground Floor, St. Michael, BB14004.

Barbados

[74] Bird & Bird

6/F, The Annex, Central Plaza

18 Harbour Road

Hong Kong

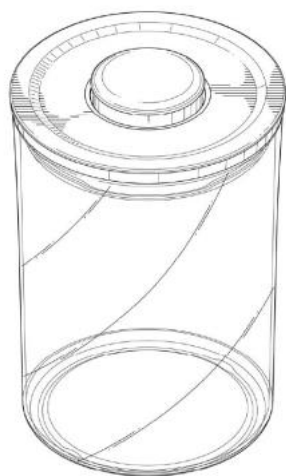

[11] 2015433.8M002

[15] 17-01-2020

[30] 18-07-2019 / US / 29/698,648

[51] Cl. 9-03

[54] 容器

Container

[73] Helen of Troy Limited

The Financial Services Centre,

Bishop's Court Hill Suite 1,

Ground Floor, St. Michael, BB14004.

Barbados

[74] Bird & Bird

6/F, The Annex, Central Plaza

18 Harbour Road

Hong Kong

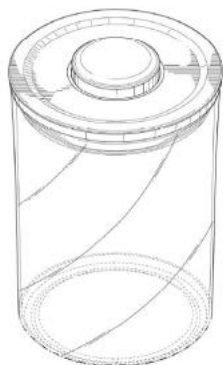

[11] 2015433.8M003

[15] 17-01-2020

[30] 18-07-2019 / US / 29/698,648

[51] Cl. 9-03

[54] 容器

Container

[73] Helen of Troy Limited

The Financial Services Centre,
Bishop's Court Hill Suite 1,
Ground Floor, St. Michael, BB14004.
Barbados

[74] Bird & Bird

6/F, The Annex, Central Plaza
18 Harbour Road
Hong Kong

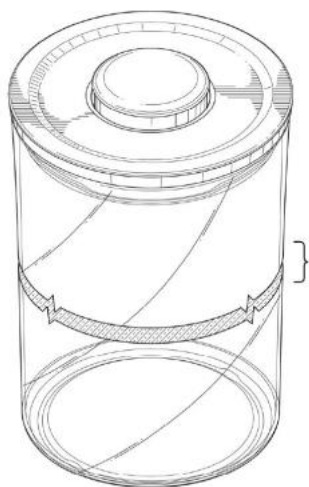

- [11] 2015435.3
[15] 17-01-2020
[30] 19-07-2019 / US / 29/698,791
[51] Cl. 24-02
[54] 手持式醫療儀器
Handheld medical instrument
[73] 賽諾秀有限責任公司
Cynosure, LLC
5 Carlisle Road,
Westford, MA 01886,
United States
[74] HNC INNOVATION LIMITED
Units 1205-1208, Cyberport 2,
No. 100, Cyberport Road,
Hong Kong



-
- [11] 2015436.5M001
[15] 17-01-2020
[30] 19-07-2019 / US / 29/698,791
[51] Cl. 24-02
[54] 手持式醫療儀器及對接底座
Handheld medical instrument and docking base
[73] 賽諾秀有限責任公司
Cynosure, LLC
5 Carlisle Road,
Westford, MA 01886,
United States
[74] HNC INNOVATION LIMITED
Units 1205-1208, Cyberport 2,

No. 100 Cyberport Road,
Hong Kong



[11] 2015436.5M002

[15] 17-01-2020

[30] 19-07-2019 / US / 29/698,791

[51] Cl. 24-02

[54] 手持式醫療儀器及對接底座
Handheld medical instrument and docking base

[73] 賽諾秀有限責任公司
Cynosure, LLC
5 Carlisle Road,
Westford, MA 01886,
United States

[74] HNC INNOVATION LIMITED
Units 1205-1208, Cyberport 2,
No. 100 Cyberport Road,
Hong Kong

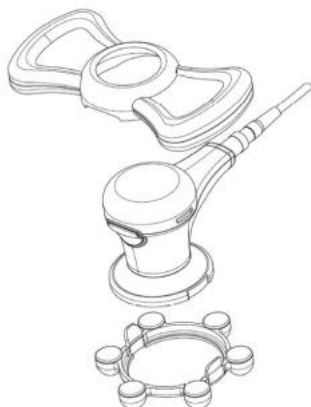

- [11] 2015436.5M003
- [15] 17-01-2020
- [30] 19-07-2019 / US / 29/698,791
- [51] Cl. 24-02
- [54] 手持式醫療儀器及對接底座
Handheld medical instrument and docking base
- [73] 賽諾秀有限責任公司
Cynosure, LLC
5 Carlisle Road,
Westford, MA 01886,
United States
- [74] HNC INNOVATION LIMITED
Units 1205-1208, Cyberport 2,
No. 100 Cyberport Road,
Hong Kong



-
- [11] 2015436.5M004
 - [15] 17-01-2020
 - [30] 19-07-2019 / US / 29/698,791
 - [51] Cl. 24-02
 - [54] 手持式醫療儀器及對接底座
Handheld medical instrument and docking base
 - [73] 賽諾秀有限責任公司
Cynosure, LLC
5 Carlisle Road,
Westford, MA 01886,
United States
 - [74] HNC INNOVATION LIMITED
Units 1205-1208, Cyberport 2,

No. 100 Cyberport Road,
Hong Kong



[11] 2015436.5M005

[15] 17-01-2020

[30] 19-07-2019 / US / 29/698,791

[51] Cl. 24-02

[54] 手持式醫療儀器及對接底座

Handheld medical instrument and docking base

[73] 賽諾秀有限責任公司

Cynosure, LLC

5 Carlisle Road,

Westford, MA 01886,

United States

[74] HNC INNOVATION LIMITED

Units 1205-1208, Cyberport 2,

No. 100 Cyberport Road,

Hong Kong

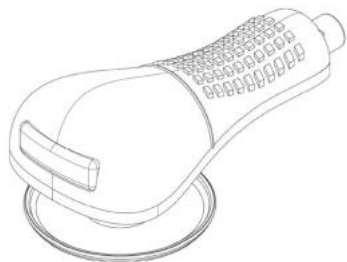

[11] 2015440.3

[15] 17-01-2020

[30] 30-07-2019 / CA, MC, MA, RU, SG, CH, TN, TR, GB, US, EU, JP, KR / DM/204 457

[51] Cl. 2-07

[54] 皮帶用扣子
Buckle for belt

[73] HERMES SELLIER
24, rue du Faubourg Saint Honoré,
F-75008 Paris,
France

[74] DEACONS
5th Floor, Alexandra House,
Central,
Hong Kong

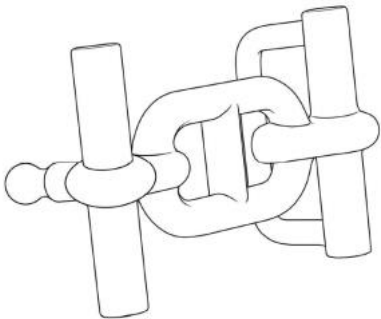

[11] 2015441.5

[15] 17-01-2020

[30] 26-07-2019 / NO, SG, CH, TN, TR, GB, EU, KR / DM/204 509

[51] Cl. 3-01

[54] 手袋
Handbag

[73] HERMES SELLIER
24, rue du Faubourg Saint Honoré,
F-75008 Paris,
France

[74] DEACONS
5th Floor, Alexandra House,
Central,
Hong Kong



[11] 2015442.7

[15] 17-01-2020

[30] 26-07-2019 / CA, EG, MC, MA, NO, RU, SG, CH, TN, TR, UA, GB,
US, EU, JP, KR / DM/204 462

[51] Cl. 3-01

[54] 袋
Bag

[73] HERMES SELIER
24, rue du Faubourg Saint Honoré,
F-75008 Paris,
France

[74] DEACONS
5th Floor, Alexandra House,
Central,
Hong Kong

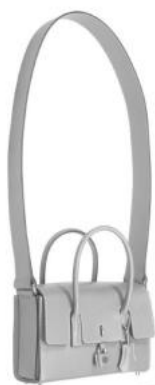

[11] 2015443.9

[15] 17-01-2020

[30] 26-07-2019 / CA, EG, MC, MA, NO, RU, SG, CH, TN, TR, UA, GB,
US, EU, JP, KR / DM/204 360

[51] Cl. 3-01

[54] 手袋
Handbag

[73] HERMES SELLIER
24, rue du Faubourg Saint Honoré,
F-75008 Paris,
France

[74] DEACONS
5th Floor, Alexandra House,
Central,
Hong Kong



[11] 2015444.1

[15] 17-01-2020

[30] 26-07-2019 / CA, EG, MC, MA, NO, RU, SG, CH, TN, TR, GB, US,
EU, JP, KR / DM/204 461

[51] Cl. 3-01

[54] 手袋
Handbag

[73] HERMES SELLIER
24, rue du Faubourg Saint Honoré,
F-75008 Paris,
France

[74] DEACONS
5th Floor, Alexandra House,
Central,
Hong Kong



[11] 2015446.6

[15] 17-01-2020

[30] 19-07-2019 / GB / 6066179

[51] Cl. 3-01

[54] 行李袋

Travelling bag

[73] Coolside Limited
3 Cadogan Street,
GLASGOW, G2 6QE,
United Kingdom

[74] LETTERS & THOO LIMITED
Suite 1008, Prosperity Millennia Plaza,
663 King's Road,
Quarry Bay, Hong Kong

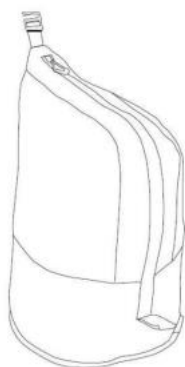



香港特別行政區政府知識產權署外觀設計註冊處

The Government of the Hong Kong Special Administrative Region

Designs Registry, Intellectual Property Department

根據註冊外觀設計條例第 28 條，下列註冊外觀設計因未繳續期費而停止有效。

各組記項按註冊外觀設計停止有效日期及註冊編號先後次序排列。

Registered designs ceased through non-payment of renewal fees under section 28 of the Registered Designs Ordinance. Entries are listed below under their expiry dates.

09-04-2020 - 15-04-2020**09-04-2020**1500846.1M001
1500846.1M002
1500853.5
1500854.7**10-04-2020**0500732.7
0500735.4**11-04-2020**0500747.9
0500749.3
0500752.9**12-04-2020**0010427.7
0500759.4
1000650.0
1000652.4
1000662.5
1000848.0
1500855.0M004
1500855.0M005
1500855.0M006
1500855.0M007
1500856.2M001
1500856.2M002
1500856.2M003
1500856.2M004
1500856.2M005
1500860.0
1500861.2**13-04-2020**1000663.7
1000665.2
1000666.4
1500865.1M001
1500865.1M002
1500865.1M003
1500865.1M004
1500865.1M005
1500865.1M007**14-04-2020**0500790.9
1000675.3
1000676.5
1500867.5
1500868.7
1500872.5
1500873.7M001
1500873.7M002
1500873.7M003**15-04-2020**1000677.7
1000679.1M001
1000681.5
1000682.7
1000684.1M001
1000684.1M002
1000684.1M003
1000684.1M004
1500874.9



香港特別行政區政府知識產權署外觀設計註冊處

The Government of the Hong Kong Special Administrative Region

Designs Registry, Intellectual Property Department

根據註冊外觀設計規則第 31 條刪除的註冊外觀設計。各組記項按註冊外觀設計刪除日期及註冊編號先後次序排列。

Registered designs removed under section 31 of the Registered Designs Rules. Entries are listed below under their removal dates.

22-05-2020 - 28-05-2020

22-05-2020		0901702.9
1401910.7	25-05-2020	0901705.6M002
1401913.3	0412337.2	1401944.8
1401914.5	0901685.2	1401945.1
1401915.8	1401921.0	1401946.3
1401916.0	1401925.9M001	
1401917.2	1401925.9M002	28-05-2020
1401918.4M001	1401925.9M003	0901707.0
1401918.4M002	1401925.9M004	0901708.2
1401920.8M002	1401925.9M006	0901709.4
	1401926.1	0901710.6
23-05-2020	1401927.3	0901711.8
0412275.0	1401928.5	0901712.0
	1401929.7	0901713.2
24-05-2020	1401930.9	0901714.4
0412321.8M001	1401931.1	0901715.7
0412321.8M002	1401932.3	0901716.9M003
0901669.8	1401933.5	0901716.9M004
0901671.2M001	1401934.7	1401953.7
0901671.2M002	1401935.0	1401955.2M001
0901671.2M003	1401937.4	1401955.2M002
0901671.2M004	9911358.9M001	9911383.1
0901671.2M005	9911358.9M002	
0901671.2M006		
0901671.2M007	26-05-2020	
0901671.2M008	0412343.4	
0901671.2M009	1401941.2	
0901671.2M010	1401942.4M001	
0901671.2M011	1401943.6	
0901671.2M012	9911363.9	
0901671.2M013		
0901671.2M014	27-05-2020	
0901671.2M015	0901695.3	
0901675.1	0901701.7	



香港特別行政區政府知識產權署外觀設計註冊處

The Government of the Hong Kong Special Administrative Region

Designs Registry, Intellectual Property Department

根據註冊外觀設計條例第 76 條，更正已提交文件中的錯誤

Correction of errors in filed documents under section 76 of the Registered Designs Ordinance

下列在 13.03.2020 官方公報刊登的更正錯誤的請求已在 14.05.2020 獲准許

The following request for correction of error advertised in the official journal on 13.03.2020 was allowed on 14.05.2020

[21] 1914713.9M001-M002

[71] 北京小米移動軟體有限公司 Beijing Xiaomi Mobile Software Co., Ltd.