

香港知識產權公報

Hong Kong Intellectual Property Journal

2021年11月12日
12 November 2021

目錄 Contents

根據註冊外觀設計條例第 25 條註冊的外觀設計

Designs Registered under section 25 of the Registered Designs Ordinance

按註冊編號排列

Arranged by Registration Number

根據註冊外觀設計條例(第 522 章)公布的其他公告

Other Notices Published under the Registered Designs Ordinance (Cap. 522)

根據註冊外觀設計條例第 28 條，註冊外觀設計因未繳續期費而停止有效

Registered designs ceased through non-payment of renewal fees under section 28 of the Registered Designs Ordinance

根據註冊外觀設計規則第 31 條刪除的註冊外觀設計

Registered designs removed under section 31 of the Registered Designs Rules

根據註冊外觀設計條例第 45 條，撤銷註冊

Revocation of Registration under section 45 of the Registered Designs Ordinance

以下事項沒有記錄

No Records for the Following Matters

根據註冊外觀設計條例第 30 條放棄的外觀設計的註冊

Surrender of Registration of Design under section 30 of the Registered Designs Ordinance

根據註冊外觀設計規則第 37 條，向處長作出轉介

Reference to Registrar under section 37 of the Registered Designs Rules

根據註冊外觀設計規則第 46 條，向法院作出轉介

Reference to Court under section 46 of the Registered Designs Rules

根據註冊外觀設計規則第 63 條對不符合規定之處作出糾正

Rectification of Irregularities under section 63 of the Registered Designs Rules

根據註冊外觀設計條例第 66 條，糾正註冊紀錄冊

Rectification of Register under section 66 of the Registered Designs Ordinance

根據註冊外觀設計條例第 67 條 更正註冊紀錄冊內的錯誤

Correction of errors in Register under section 67 of the Registered Designs Ordinance

根據註冊外觀設計條例第 67 及 76 條，更正註冊紀錄冊內及已提交文件中的錯誤

Correction of Errors in Register and in Filed Documents under sections 67 and 76 of the Registered Designs Ordinance

根據註冊外觀設計條例第 76 條，更正已提交文件中的錯誤

Correction of errors in filed documents under section 76 of the Registered Designs Ordinance

勘誤

Corrigendum

註冊外觀設計公告註釋

Notes on advertisements of registration of designs

方括號表示下列資料：

Square brackets indicate the following data：

[11] 註冊編號 Registration number / 聯合王國註冊編號 United Kingdom registration number

[15] 註冊日期 Registration date / 當作註冊日期 Deemed registration date / 聯合王國註冊日期 United Kingdom registration date

[17] 註冊有效期屆滿日期 Expiry date of the period of registration

[22] 提交日期 Filing date / 當作提交日期 Deemed filing date / 聯合王國提交日期 United Kingdom filing date

[30] 聲稱享有的優先權（提交日期 / 巴黎公約國或世界貿易組織成員 / 申請編號） Priority claimed (filing date / Paris Convention country or WTO member / application number)

[51] 國際外觀設計分類號（洛迦諾分類號） International Classification of designs (Locarno Classification)

[54] 物品 Article

[55] 外觀設計的表述 Representation of the design

[62] 分開前的申請編號及提交日期 Application number before division and filing date

[66] 過往註冊的聯繫外觀設計註冊編號 / 日期 Registration No. / Date of Previous Registration for Association

[72] 設計人 Designer

[73] 擁有人姓名和地址 Name and address of the owner

[74] 代理人 Agent /送達地址 Address for service



香港特別行政區政府知識產權署外觀設計註冊處

The Government of the Hong Kong Special Administrative Region

Designs Registry, Intellectual Property Department

根據註冊外觀設計條例第 25 條註冊的外觀設計

Designs registered under section 25 of the Registered Designs Ordinance

按註冊編號排列

Arranged by Registration Number

- [11] 2016080.0
- [15] 29-04-2020
- [30] 29-10-2019 / JP / 024140 of 2019
- [51] Cl. 14-01
- [54] 耳機連盒
Earphone with case
- [73] SONY CORPORATION
1-7-1 Konan, Minato-Ku,
Tokyo 108-0075,
Japan
- [74] UNITALEN ATTORNEYS AT LAW LIMITED
Rm 1201, 12/F, Golden Era Plaza,
39-55 Sai Yee St,
Mongkok, Kln, Hong Kong



-
- [11] 2117774.4M001
 - [15] 30-03-2021
 - [30] 05-10-2020 / JP / 021371 of 2020
 - [51] Cl. 14-04

[54] 圖標

Icons

[73] SONY INTERACTIVE ENTERTAINMENT INC.

1-7-1 Konan,
Minato-Ku, Tokyo,
Japan

[74] CHINA PATENT AGENT (HONG KONG) LIMITED

22/F, Great Eagle Centre,
23 Harbour Road,
Wanchai, Hong Kong

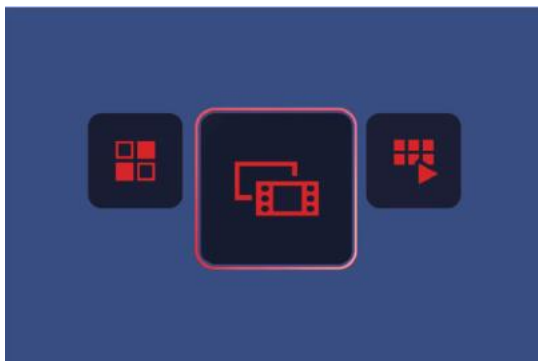

[11] 2117774.4M002

[15] 30-03-2021

[30] 05-10-2020 / JP / 021372 of 2020

[51] Cl. 14-04

[54] 圖標

Icons

[73] SONY INTERACTIVE ENTERTAINMENT INC.

1-7-1 Konan,
Minato-Ku, Tokyo,
Japan

[74] CHINA PATENT AGENT (HONG KONG) LIMITED

22/F, Great Eagle Centre,
23 Harbour Road,
Wanchai, Hong Kong



[11] 2117774.4M003

[15] 30-03-2021

[30] 05-10-2020 / JP / 021373 of 2020

[51] Cl. 14-04

[54] 圖標
Icons

[73] SONY INTERACTIVE ENTERTAINMENT INC.
1-7-1 Konan,
Minato-Ku, Tokyo,
Japan

[74] CHINA PATENT AGENT (HONG KONG) LIMITED
22/F, Great Eagle Centre,
23 Harbour Road,
Wanchai, Hong Kong



[11] 2118023.3

[15] 17-05-2021

[30] 17-11-2020 / US / 29/758,611

[51] Cl. 10-05

[54] 建築控制器
Building controller

[73] HONEYWELL INTERNATIONAL INC.
Intellectual Property Services Group 300 S.,
Tryon Street,
Suite 600 Charlotte, North Carolina 28202,
United States

[74] CHINA PATENT AGENT (HONG KONG) LIMITED
22/F, Great Eagle Centre, 23 Harbour Road,
Wanchai
HONG KONG
HONG KONG

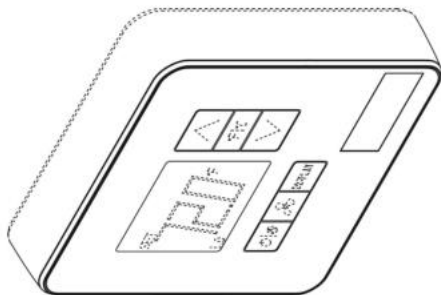

[11] 2118199.5

[15] 18-06-2021

[30] 21-12-2020 / DE / 40 2020 101 233.5

[51] Cl. 12-08

[54] 汽車

Motor vehicle

[73] VOLKSWAGEN AKTIENGESELLSCHAFT

Berliner Ring 2,

38440 Wolfsburg,

Germany

[74] CHINA PATENT AGENT (HONG KONG) LIMITED

22/F, Great Eagle Centre,

23 Harbour Road,

Wanchai, Hong Kong



[11] 2118201.1

[15] 18-06-2021

[30] 21-12-2020 / DE / 40 2020 101 234.3

[51] Cl. 12-08

[54] 汽車

Motor vehicle

[73] VOLKSWAGEN AKTIENGESELLSCHAFT

Berliner Ring 2,

38440 Wolfsburg,
Germany

[74] CHINA PATENT AGENT (HONG KONG) LIMITED
22/F, Great Eagle Centre,
23 Harbour Road,
Wanchai, Hong Kong



[11] 2118203.5

[15] 18-06-2021

[30] 21-12-2020 / DE / 40 2020 101 234.3

[51] Cl. 21-01

[54] 玩具車
Toy vehicle

[73] VOLKSWAGEN AKTIENGESELLSCHAFT
Berliner Ring 2,
38440 Wolfsburg,
Germany

[74] CHINA PATENT AGENT (HONG KONG) LIMITED
22/F, Great Eagle Centre,
23 Harbour Road,
Wanchai, Hong Kong



[11] 2118204.7

[15] 18-06-2021

[30] 21-12-2020 / DE / 40 2020 101 233.5

[51] Cl. 21-01

[54] 玩具車
Toy vehicle

[73] VOLKSWAGEN AKTIENGESELLSCHAFT
Berliner Ring 2,
38440 Wolfsburg,
Germany

[74] CHINA PATENT AGENT (HONG KONG) LIMITED
22/F, Great Eagle Centre,
23 Harbour Road,
Wanchai, Hong Kong



[11] 2118225.2M001

[15] 23-06-2021

[30] 19-01-2021 / US / 29/766,924

[51] Cl. 26-04

[54] 帶有可拆除手帶的可穿戴發光模組
Wearable light emitting module with a removable band

[73] Averia Electronics, Inc.
142 W. 57th Street,
#9-117 New York, NY 10019,
United States of America

[74] CHINAHONGKONG PATENT LIMITED
1502, 15/F, Capital Centre
151 Gloucester Road, Wanchai
Hong Kong
HONG KONG

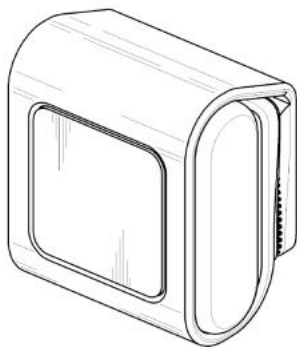

[11] 2118225.2M002

[15] 23-06-2021

[30] 19-01-2021 / US / 29/766,927

[51] Cl. 26-04

[54] 帶有可拆除手帶的可穿戴發光模組

Wearable light emitting module with a removable band

[73] Averia Electronics, Inc.

142 W. 57th Street,

#9-117 New York, NY 10019,

United States of America

[74] CHINAHONGKONG PATENT LIMITED

1502, 15/F, Capital Centre

151 Gloucester Road, Wanchai

Hong Kong

HONG KONG



[11] 2118226.4M001

[15] 23-06-2021

[30] 23-12-2020 / JP / 027772 of 2020

[51] Cl. 7-01

[54] 奶瓶

Nursing bottle

[73] PIGEON CORPORATION

4-4, Nihonbashi Hisamatsu-Cho,

Chuo-ku, Tokyo,

Japan

[74] CHINA PATENT AGENT (HONG KONG) LIMITED

22/F, Great Eagle Centre,

23 Harbour Road,

Wanchai, Hong Kong



[11] 2118226.4M002

[15] 23-06-2021

[30] 23-12-2020 / JP / 027771 of 2020

[51] Cl. 7-01

[54] 奶嘴

Teat

[73] PIGEON CORPORATION

4-4, Nihonbashi Hisamatsu-Cho,

Chuo-ku, Tokyo,

Japan

[74] CHINA PATENT AGENT (HONG KONG) LIMITED

22/F, Great Eagle Centre,

23 Harbour Road,

Wanchai, Hong Kong



[11] 2118234.0M001

[15] 23-06-2021

[30] 20-05-2021 / EU / 008546709-0005

[51] Cl. 28-03

[54] 電動剃鬚刀

Electrical shaver

[73] Koninklijke Philips N.V.

High Tech Campus 52,
5656 AG Eindhoven,
Netherlands

[74] Rouse & Co. International (Overseas) Limited

26th Floor, Tesbury Centre
28 Queen's Road East, Wan Chai
Hong Kong



[11] 2118234.0M002

[15] 23-06-2021

[30] 20-05-2021 / EU / 008546709-0011

[51] Cl. 28-03

[54] 電動剃鬚刀

Electrical shaver

[73] Koninklijke Philips N.V.

High Tech Campus 52,
5656 AG Eindhoven,
Netherlands

[74] Rouse & Co. International (Overseas) Limited

26th Floor, Tesbury Centre
28 Queen's Road East, Wan Chai
Hong Kong



[11] 2118234.0M003

[15] 23-06-2021

[30] 20-05-2021 / EU / 008546709-0023

[51] Cl. 28-03

[54] 電動剃鬚刀

Electrical shaver

[73] Koninklijke Philips N.V.

High Tech Campus 52,

5656 AG Eindhoven,

Netherlands

[74] Rouse & Co. International (Overseas) Limited

26th Floor, Tesbury Centre

28 Queen's Road East, Wan Chai

Hong Kong



- [11] 2118234.0M004
[15] 23-06-2021
[30] 20-05-2021 / EU / 008546709-0026
[51] Cl. 28-03
[54] 電動剃鬚刀
Electrical shaver
[73] Koninklijke Philips N.V.
High Tech Campus 52,
5656 AG Eindhoven,
Netherlands
[74] Rouse & Co. International (Overseas) Limited
26th Floor, Tesbury Centre
28 Queen's Road East, Wan Chai
Hong Kong



-
- [11] 2118234.0M005
[15] 23-06-2021
[30] 20-05-2021 / EU / 008546709-0038
[51] Cl. 28-03
[54] 電動剃鬚刀
Electrical shaver
[73] Koninklijke Philips N.V.
High Tech Campus 52,
5656 AG Eindhoven,
Netherlands
[74] Rouse & Co. International (Overseas) Limited
26th Floor, Tesbury Centre
28 Queen's Road East, Wan Chai
Hong Kong



[11] 2118234.0M006

[15] 23-06-2021

[30] 20-05-2021 / EU / 008546709-0044

[51] Cl. 28-03

[54] 電動剃鬚刀

Electrical shaver

[73] Koninklijke Philips N.V.

High Tech Campus 52,

5656 AG Eindhoven,

Netherlands

[74] Rouse & Co. International (Overseas) Limited

26th Floor, Tesbury Centre

28 Queen's Road East, Wan Chai

Hong Kong



- [11] 2118234.0M007
[15] 23-06-2021
[30] 20-05-2021 / EU / 008546709-0059
[51] Cl. 28-03
[54] 電動剃鬚刀
Electrical shaver
[73] Koninklijke Philips N.V.
High Tech Campus 52,
5656 AG Eindhoven,
Netherlands
[74] Rouse & Co. International (Overseas) Limited
26th Floor, Tesbury Centre
28 Queen's Road East, Wan Chai
Hong Kong



-
- [11] 2118234.0M008
[15] 23-06-2021
[30] 20-05-2021 / EU / 008546709-0068
[51] Cl. 28-03
[54] 電動剃鬚刀
Electrical shaver
[73] Koninklijke Philips N.V.
High Tech Campus 52,
5656 AG Eindhoven,
Netherlands
[74] Rouse & Co. International (Overseas) Limited
26th Floor, Tesbury Centre
28 Queen's Road East, Wan Chai
Hong Kong



[11] 2118234.0M009

[15] 23-06-2021

[30] 20-05-2021 / EU / 008546709-0080

[51] Cl. 28-03

[54] 電動剃鬚刀

Electrical shaver

[73] Koninklijke Philips N.V.

High Tech Campus 52,

5656 AG Eindhoven,

Netherlands

[74] Rouse & Co. International (Overseas) Limited

26th Floor, Tesbury Centre

28 Queen's Road East, Wan Chai

Hong Kong



- [11] 2118234.0M010
[15] 23-06-2021
[30] 26-05-2021 / EU / 008553796-0002
[51] Cl. 28-03
[54] 電動剃鬚刀
Electrical shaver
[73] Koninklijke Philips N.V.
High Tech Campus 52,
5656 AG Eindhoven,
Netherlands
[74] Rouse & Co. International (Overseas) Limited
26th Floor, Tesbury Centre
28 Queen's Road East, Wan Chai
Hong Kong

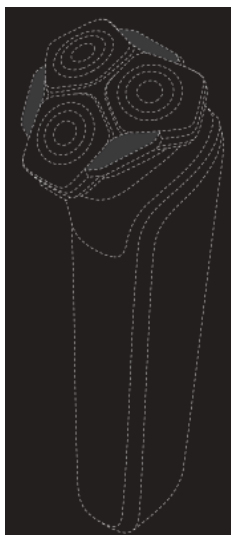

-
- [11] 2118234.0M011
[15] 23-06-2021
[30] 26-05-2021 / EU / 008553796-0005
[51] Cl. 28-03
[54] 電動剃鬚刀
Electrical shaver
[73] Koninklijke Philips N.V.
High Tech Campus 52,
5656 AG Eindhoven,
Netherlands
[74] Rouse & Co. International (Overseas) Limited
26th Floor, Tesbury Centre
28 Queen's Road East, Wan Chai
Hong Kong

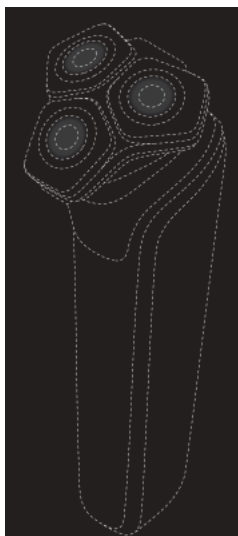

[11] 2118234.0M012

[15] 23-06-2021

[30] 26-05-2021 / EU / 008553796-0008

[51] Cl. 28-03

[54] 電動剃鬚刀

Electrical shaver

[73] Koninklijke Philips N.V.

High Tech Campus 52,

5656 AG Eindhoven,

Netherlands

[74] Rouse & Co. International (Overseas) Limited

26th Floor, Tesbury Centre

28 Queen's Road East, Wan Chai

Hong Kong

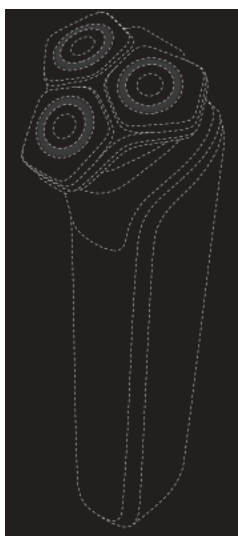

- [11] 2118234.0M013
[15] 23-06-2021
[30] 26-05-2021 / EU / 008553796-0011
[51] Cl. 28-03
[54] 電動剃鬚刀
Electrical shaver
[73] Koninklijke Philips N.V.
High Tech Campus 52,
5656 AG Eindhoven,
Netherlands
[74] Rouse & Co. International (Overseas) Limited
26th Floor, Tesbury Centre
28 Queen's Road East, Wan Chai
Hong Kong

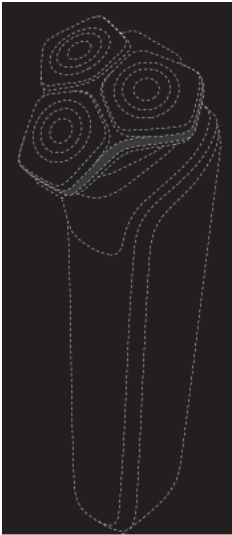

-
- [11] 2118234.0M014
[15] 23-06-2021
[30] 26-05-2021 / EU / 008553796-0014
[51] Cl. 28-03
[54] 電動剃鬚刀
Electrical shaver
[73] Koninklijke Philips N.V.
High Tech Campus 52,
5656 AG Eindhoven,
Netherlands
[74] Rouse & Co. International (Overseas) Limited
26th Floor, Tesbury Centre
28 Queen's Road East, Wan Chai
Hong Kong

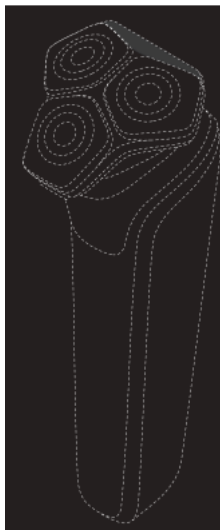

[11] 2118234.0M015

[15] 23-06-2021

[30] 26-05-2021 / EU / 008553796-0017

[51] Cl. 28-03

[54] 電動剃鬚刀

Electrical shaver

[73] Koninklijke Philips N.V.

High Tech Campus 52,

5656 AG Eindhoven,

Netherlands

[74] Rouse & Co. International (Overseas) Limited

26th Floor, Tesbury Centre

28 Queen's Road East, Wan Chai

Hong Kong

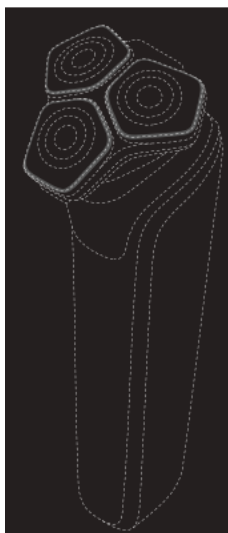

- [11] 2118234.0M016
[15] 23-06-2021
[30] 26-05-2021 / EU / 008553796-0020
[51] Cl. 28-03
[54] 電動剃鬚刀
Electrical shaver
[73] Koninklijke Philips N.V.
High Tech Campus 52,
5656 AG Eindhoven,
Netherlands
[74] Rouse & Co. International (Overseas) Limited
26th Floor, Tesbury Centre
28 Queen's Road East, Wan Chai
Hong Kong



-
- [11] 2118234.0M017
[15] 23-06-2021
[30] 26-05-2021 / EU / 008553796-0023
[51] Cl. 28-03
[54] 電動剃鬚刀
Electrical shaver
[73] Koninklijke Philips N.V.
High Tech Campus 52,
5656 AG Eindhoven,
Netherlands
[74] Rouse & Co. International (Overseas) Limited
26th Floor, Tesbury Centre
28 Queen's Road East, Wan Chai
Hong Kong

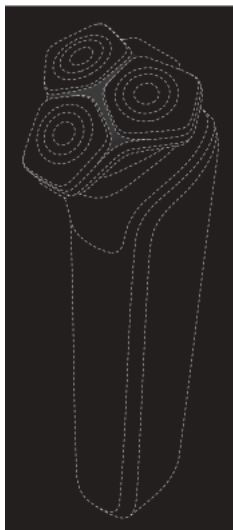

[11] 2118234.0M018

[15] 23-06-2021

[30] 26-05-2021 / EU / 008553796-0026

[51] Cl. 28-03

[54] 電動剃鬚刀

Electrical shaver

[73] Koninklijke Philips N.V.

High Tech Campus 52,

5656 AG Eindhoven,

Netherlands

[74] Rouse & Co. International (Overseas) Limited

26th Floor, Tesbury Centre

28 Queen's Road East, Wan Chai

Hong Kong



- [11] 2118234.0M019
[15] 23-06-2021
[30] 26-05-2021 / EU / 008553796-0029
[51] Cl. 28-03
[54] 電動剃鬚刀
Electrical shaver
[73] Koninklijke Philips N.V.
High Tech Campus 52,
5656 AG Eindhoven,
Netherlands
[74] Rouse & Co. International (Overseas) Limited
26th Floor, Tesbury Centre
28 Queen's Road East, Wan Chai
Hong Kong



-
- [11] 2118234.0M020
[15] 23-06-2021
[30] 26-05-2021 / EU / 008553796-0032
[51] Cl. 28-03
[54] 電動剃鬚刀
Electrical shaver
[73] Koninklijke Philips N.V.
High Tech Campus 52,
5656 AG Eindhoven,
Netherlands
[74] Rouse & Co. International (Overseas) Limited
26th Floor, Tesbury Centre
28 Queen's Road East, Wan Chai
Hong Kong

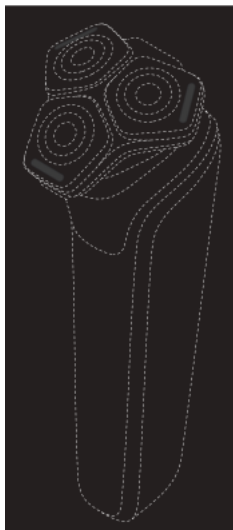

[11] 2118234.0M021

[15] 23-06-2021

[30] 26-05-2021 / EU / 008553796-0035

[51] Cl. 28-03

[54] 電動剃鬚刀

Electrical shaver

[73] Koninklijke Philips N.V.

High Tech Campus 52,

5656 AG Eindhoven,

Netherlands

[74] Rouse & Co. International (Overseas) Limited

26th Floor, Tesbury Centre

28 Queen's Road East, Wan Chai

Hong Kong



- [11] 2118234.0M022
[15] 23-06-2021
[30] 26-05-2021 / EU / 008553796-0038
[51] Cl. 28-03
[54] 電動剃鬚刀
Electrical shaver
[73] Koninklijke Philips N.V.
High Tech Campus 52,
5656 AG Eindhoven,
Netherlands
[74] Rouse & Co. International (Overseas) Limited
26th Floor, Tesbury Centre
28 Queen's Road East, Wan Chai
Hong Kong



-
- [11] 2118234.0M023
[15] 23-06-2021
[30] 26-05-2021 / EU / 008553796-0041
[51] Cl. 28-03
[54] 電動剃鬚刀
Electrical shaver
[73] Koninklijke Philips N.V.
High Tech Campus 52,
5656 AG Eindhoven,
Netherlands
[74] Rouse & Co. International (Overseas) Limited
26th Floor, Tesbury Centre
28 Queen's Road East, Wan Chai
Hong Kong

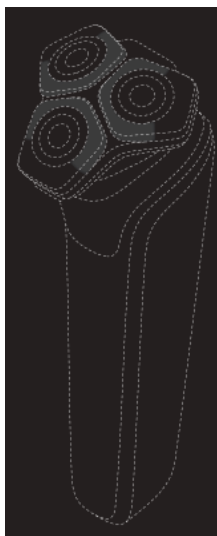

[11] 2118234.0M024

[15] 23-06-2021

[30] 01-06-2021 / EU / 008560866-0025

[51] Cl. 28-03

[54] 電動剃鬚刀

Electrical shaver

[73] Koninklijke Philips N.V.

High Tech Campus 52,

5656 AG Eindhoven,

Netherlands

[74] Rouse & Co. International (Overseas) Limited

26th Floor, Tesbury Centre

28 Queen's Road East, Wan Chai

Hong Kong

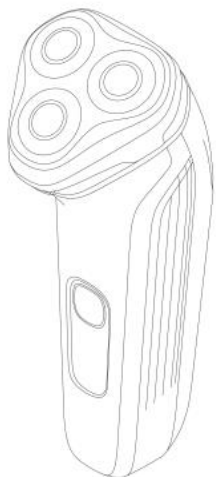

- [11] 2118234.0M025
[15] 23-06-2021
[30] 01-06-2021 / EU / 008560866-0026
[51] Cl. 28-03
[54] 電動剃鬚刀
Electrical shaver
[73] Koninklijke Philips N.V.
High Tech Campus 52,
5656 AG Eindhoven,
Netherlands
[74] Rouse & Co. International (Overseas) Limited
26th Floor, Tesbury Centre
28 Queen's Road East, Wan Chai
Hong Kong



-
- [11] 2118234.0M026
[15] 23-06-2021
[30] 01-06-2021 / EU / 008560866-0040
[51] Cl. 28-03
[54] 電動剃鬚刀
Electrical shaver
[73] Koninklijke Philips N.V.
High Tech Campus 52,
5656 AG Eindhoven,
Netherlands
[74] Rouse & Co. International (Overseas) Limited
26th Floor, Tesbury Centre
28 Queen's Road East, Wan Chai
Hong Kong



[11] 2118268.2

[15] 02-07-2021

[30] 15-02-2021 / EU / 008434914-0001

[51] Cl. 12-08

[54] 汽車

Automobile

[73] Dr. Ing. h.c. F. Porsche Aktiengesellschaft

Porscheplatz 1,
70435 Stuttgart,
Germany

[74] WENPING PATENT & TRADE MARK AGENT LIMITED

1701 Tung Wai Commercial Building,
111 Gloucester Road,
Hong Kong



[11] 2118269.4

[15] 02-07-2021

[30] 15-02-2021 / EU / 008434922-0001

- [51] Cl. 21-01
- [54] 模型車
Model car
- [73] Dr. Ing. h.c. F. Porsche Aktiengesellschaft
Porscheplatz 1,
70435 Stuttgart,
Germany
- [74] WENPING PATENT & TRADE MARK AGENT LIMITED
1701 Tung Wai Commercial Building,
111 Gloucester Road,
Hong Kong



-
- [11] 2118399.9M001
- [15] 26-07-2021
- [30] 26-01-2021 / EU / 008414767-0001
- [51] Cl. 7-02
- [54] 咖啡機
Coffee maker
- [73] Koninklijke Philips N.V.
High Tech Campus 52,
5656 AG Eindhoven,
Netherlands
- [74] CHANG TSI AND PARTNERS INTELLECTUAL PROPERTY (HK) LIMITED
Level 19, Two Int'l Finance Ctr,
8 Finance St,
Central, Hong Kong



[11] 2118399.9M002

[15] 26-07-2021

[30] 26-01-2021 / EU / 008414767-0002

[51] Cl. 7-01

[54] 咖啡壺

Coffee pot

[73] Koninklijke Philips N.V.

High Tech Campus 52,

5656 AG Eindhoven,

Netherlands

[74] CHANG TSI AND PARTNERS INTELLECTUAL PROPERTY (HK) LIMITED

Level 19, Two Int'l Finance Ctr,

8 Finance St,

Central, Hong Kong



[11] 2118399.9M003

[15] 26-07-2021

[30] 26-01-2021 / EU / 008414767-0003

[51] Cl. 7-02

[54] 咖啡機

Coffee maker

[73] Koninklijke Philips N.V.

High Tech Campus 52,

5656 AG Eindhoven,

Netherlands

[74] CHANG TSI AND PARTNERS INTELLECTUAL PROPERTY (HK) LIMITED

Level 19, Two Int'l Finance Ctr,

8 Finance St,

Central, Hong Kong



[11] 2118399.9M004

[15] 26-07-2021

[30] 26-01-2021 / EU / 008414767-0007

[51] Cl. 7-01

[54] 咖啡壺

Coffee pot

[73] Koninklijke Philips N.V.

High Tech Campus 52,

5656 AG Eindhoven,

Netherlands

[74] CHANG TSI AND PARTNERS INTELLECTUAL PROPERTY (HK) LIMITED

Level 19, Two Int'l Finance Ctr,

8 Finance St,

Central, Hong Kong

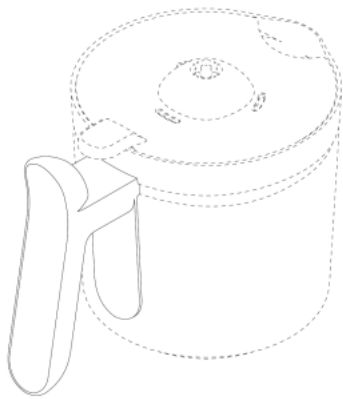

[11] 2118399.9M005

[15] 26-07-2021

[30] 26-01-2021 / EU / 008414767-0008

[51] Cl. 7-02

[54] 咖啡壺手柄

Coffee pot handle

[73] Koninklijke Philips N.V.

High Tech Campus 52,

5656 AG Eindhoven,

Netherlands

[74] CHANG TSI AND PARTNERS INTELLECTUAL PROPERTY (HK) LIMITED

Level 19, Two Int'l Finance Ctr,

8 Finance St,

Central, Hong Kong

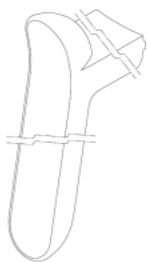

[11] 2118538.6M001

[15] 20-08-2021

[51] Cl. 10-04

[54] 呼氣檢測設備

Breath analyzer

[73] 氣葩科技有限公司

Qi Diagnostics Limited
10/F, Fuk Chiu Factory Building,
20 Bute Street,
Mong Kok, Kowloon, Hong Kong

[74] Qi Diagnostics Limited

10/F, Fuk Chiu Factory Building,
20 Bute Street,
Mong Kok, Kowloon, Hong Kong

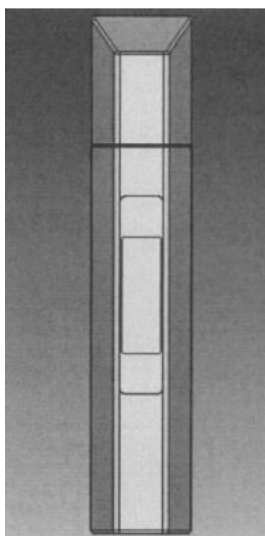

[11] 2118538.6M002

[15] 20-08-2021

[51] Cl. 10-04

[54] 呼氣檢測設備

Breath analyzer

[73] 氣葩科技有限公司

Qi Diagnostics Limited
10/F, Fuk Chiu Factory Building,
20 Bute Street,
Mong Kok, Kowloon, Hong Kong

[74] Qi Diagnostics Limited

10/F, Fuk Chiu Factory Building,
20 Bute Street,
Mong Kok, Kowloon, Hong Kong

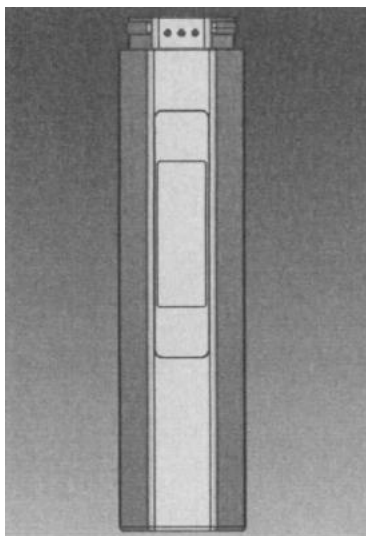

[11] 2118540.0

[15] 23-08-2021

[30] 23-02-2021 / US / 29/771,496

[51] Cl. 14-03

[54] 遙控器

Remote control

[73] 蘋果公司

APPLE INC.

One Apple Park Way, Cupertino,

California 95014,

United States of America

[74] CLT PATENT & TRADEMARK (H.K.) LIMITED

Unit 09, 34/F., Office Tower, Convention Plaza,

1 Harbour Road,

Wanchai, Hong Kong

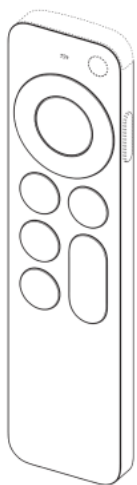

- [11] 2118609.7
[15] 03-09-2021
[30] 05-03-2021 / JP / 004560 of 2021
[51] Cl. 20-02
[54] 加油設備主體
Fueling apparatus main body
[73] TATSUNO CORPORATION
2-6, Mita 3-Chome,
Minato-Ku, Tokyo 108-0073,
Japan
[74] FEDERATION OF HONG KONG INDUSTRIES
31/F, Billion Plaza,
8 Cheung Yue Street,
Cheung Sha Wan, Kowloon, Hong Kong

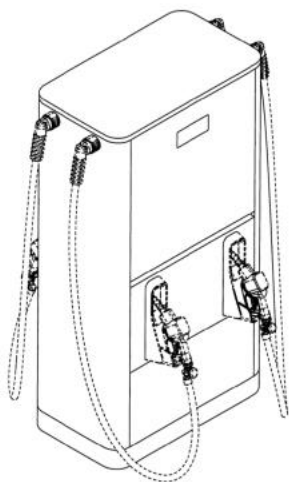

-
- [11] 2118610.9
[15] 03-09-2021
[30] 05-03-2021 / JP / 004559 of 2021
[51] Cl. 20-02
[54] 加油設備主體
Fueling apparatus main body
[73] TATSUNO CORPORATION
2-6, Mita 3-Chome,
Minato-Ku, Tokyo 108-0073,
Japan
[74] FEDERATION OF HONG KONG INDUSTRIES
31/F, Billion Plaza,
8 Cheung Yue Street,
Cheung Sha Wan, Kowloon, Hong Kong

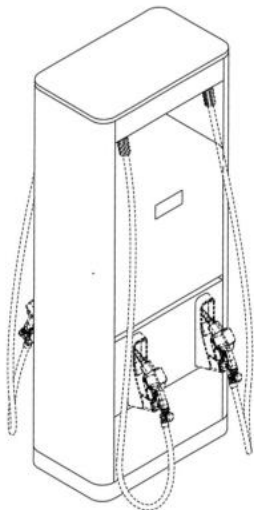

[11] 2118611.1

[15] 03-09-2021

[30] 05-03-2021 / JP / 004558 of 2021

[51] Cl. 20-02

[54] 加油設備主體

Fueling apparatus main body

[73] TATSUNO CORPORATION

2-6, Mita 3-Chome,
Minato-Ku, Tokyo 108-0073,
Japan

[74] FEDERATION OF HONG KONG INDUSTRIES

31/F, Billion Plaza,
8 Cheung Yue Street,
Cheung Sha Wan, Kowloon, Hong Kong

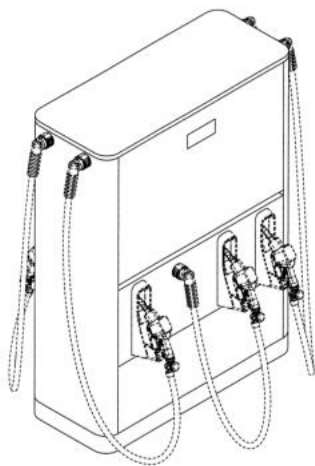

[11] 2118612.3

- [15] 03-09-2021
- [30] 05-03-2021 / JP / 004557 of 2021
- [51] Cl. 20-02
- [54] 加油設備主體
Fueling apparatus main body
- [73] TATSUNO CORPORATION
2-6, Mita 3-Chome,
Minato-Ku, Tokyo 108-0073,
Japan
- [74] FEDERATION OF HONG KONG INDUSTRIES
31/F, Billion Plaza,
8 Cheung Yue Street,
Cheung Sha Wan, Kowloon, Hong Kong

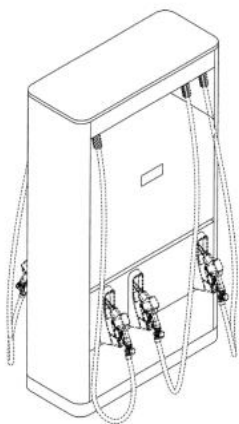

-
- [11] 2118613.5
 - [15] 03-09-2021
 - [51] Cl. 11-01
 - [54] 首飾元件
Jewellery element
 - [73] Vault Luxury Limited
香港銅鑼灣
霎東街 11 號
The Sharp 19 樓
 - [74] Vault Luxury Limited
香港銅鑼灣
霎東街 11 號
The Sharp 19 樓



-
- [11] 2118629.9
[15] 06-09-2021
[30] 15-03-2021 / MC, GB, US, EU / DM/213 336
[51] Cl. 26-01
[54] 燭臺
Candlestick
[73] PUIFORCAT
48, avenue Gabriel,
75008 Paris,
France
[74] DEACONS
5th Floor, Alexandra House,
Central,
Hong Kong



-
- [11] 2118652.7
[15] 09-09-2021
[51] Cl. 7-02

[54] 多用途升降火鍋
Multi-functional lifting hot pot

[73] 金萬興日用品有限公司
KAM MAN HING HOUSEWARES LIMITED
香港鰂魚涌
英皇道 1065 號
東達中心 7 樓 702 室

[74] 金萬興日用品有限公司
香港鰂魚涌
英皇道 1065 號
東達中心 7 樓 702 室



[11] 2118658.0

[15] 10-09-2021

[30] 09-08-2021 / MA, NO, OM, SG, CH, TN, TR, UA, GB, EU, AL /
DM/215 840

[51] Cl. 10-02

[54] 手錶
Wristwatch

[73] SWATCH AG (SWATCH SA) (SWATCH LTD.)
Nicolas G. Hayek Strasse 1,
2502 Biel/Bienne,
Switzerland

[74] SPRUSON & FERGUSON (HONG KONG) LIMITED
5001 Hopewell Centre,
183 Queen's Road East,
Wan Chai, Hong Kong



[11] 2118671.7M001

[15] 14-09-2021

[51] Cl. 23-04

[54] 香薰機

Aroma diffuser

[73] 璞真生活有限公司

PUZHEN LIFE CO., LTD

Unit 1112-1116, 11/F, Delta House,

3 On Yiu Street,

Shatin, Hong Kong

[74] FEDERATION OF HONG KONG INDUSTRIES

31/F, Billion Plaza,

8 Cheung Yue Street,

Cheung Sha Wan, Kowloon, Hong Kong

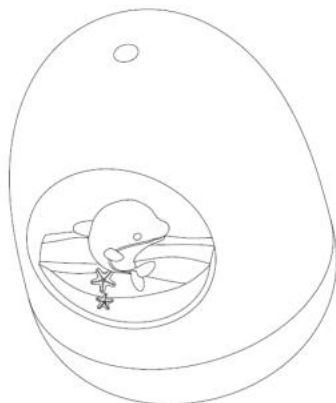

[11] 2118671.7M002

[15] 14-09-2021

[51] Cl. 23-04

[54] 香薰機

Aroma diffuser

[73] 璞真生活有限公司

PUZHEN LIFE CO., LTD

Unit 1112-1116, 11/F, Delta House,
3 On Yiu Street,
Shatin, Hong Kong

- [74] FEDERATION OF HONG KONG INDUSTRIES
31/F, Billion Plaza,
8 Cheung Yue Street,
Cheung Sha Wan, Kowloon, Hong Kong



[11] 2118671.7M003

[15] 14-09-2021

[51] Cl. 23-04

[54] 香薰機

Aroma diffuser

[73] 璞真生活有限公司

PUZHEN LIFE CO., LTD

Unit 1112-1116, 11/F, Delta House,
3 On Yiu Street,
Shatin, Hong Kong

- [74] FEDERATION OF HONG KONG INDUSTRIES
31/F, Billion Plaza,
8 Cheung Yue Street,
Cheung Sha Wan, Kowloon, Hong Kong



[11] 2118677.0M001

[15] 15-09-2021

[30] 15-03-2021 / CN / 202130137890.1

[51] Cl. 14-03

[54] 電視

Television

[73] 北京小米移動軟件有限公司

Beijing Xiaomi Mobile Software Co., Ltd.

中國內地

北京市海澱區西二旗中路 33 號院

6 號樓 8 層 018 號

[74] 隆天專利商標代理有限公司

香港

長沙灣青山道 485 號

九龍廣場 10 樓 11 室

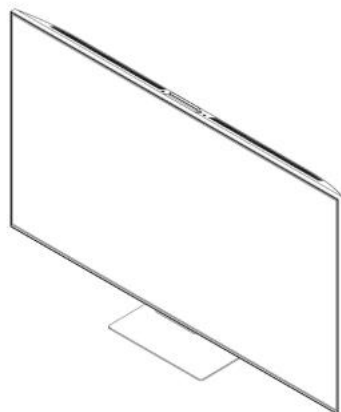

- [11] 2118677.0M002
[15] 15-09-2021
[30] 15-03-2021 / CN / 202130137890.1
[51] Cl. 14-03
[54] 電視
Television
[73] 北京小米移動軟件有限公司
Beijing Xiaomi Mobile Software Co., Ltd.
中國內地
北京市海澱區西二旗中路 33 號院
6 號樓 8 層 018 號
[74] 隆天專利商標代理有限公司
香港
長沙灣青山道 485 號
九龍廣場 10 樓 11 室

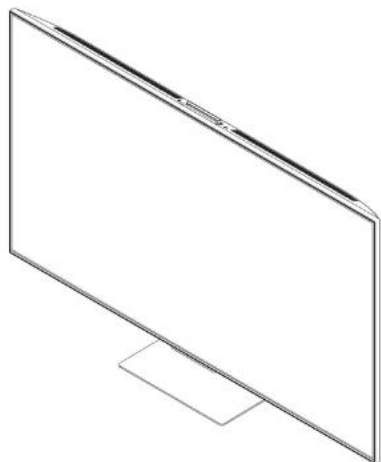

-
- [11] 2118678.2M001
[15] 15-09-2021
[30] 15-03-2021 / CN / 202130138333.1
[51] Cl. 14-99
[54] 觸控筆
Stylus pen
[73] 北京小米移動軟件有限公司
Beijing Xiaomi Mobile Software Co., Ltd.
中國內地
北京市海澱區西二旗中路 33 號院
6 號樓 8 層 018 號

- [74] 隆天專利商標代理有限公司
香港
長沙灣青山道 485 號
九龍廣場 10 樓 11 室

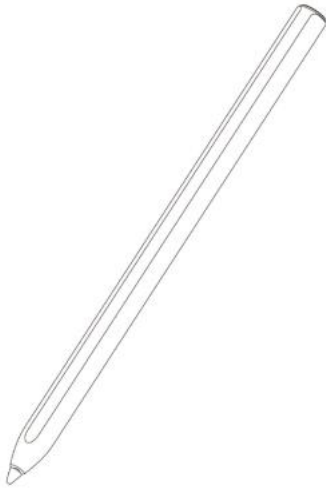

-
- [11] 2118678.2M002
[15] 15-09-2021
[30] 15-03-2021 / CN / 202130138333.1
[51] Cl. 14-99
[54] 觸控筆
Stylus pen
[73] 北京小米移動軟件有限公司
Beijing Xiaomi Mobile Software Co., Ltd.
中國內地
北京市海澱區西二旗中路 33 號院
6 號樓 8 層 018 號
[74] 隆天專利商標代理有限公司
香港
長沙灣青山道 485 號
九龍廣場 10 樓 11 室



[11] 2118680.6

[15] 15-09-2021

[51] Cl. 28-03

[54] 化妝品容器

Cosmetic container

[73] AMOREPACIFIC CORPORATION

100, Hangang-daero,

Yongsan-gu, Seoul,

Korea, Republic of

[74] TRADEMARKCN COMPANY LIMITED

Block A, 4/F., Granville Building,

14 Granville Road,

Tsim Sha Tsui, Kowloon, Hong Kong



[11] 2118681.8

[15] 15-09-2021

[51] Cl. 28-03

[54] 化妝品容器

Cosmetic container

[73] AMOREPACIFIC CORPORATION

100, Hangang-daero,

Yongsan-gu, Seoul,

Korea, Republic of

[74] TRADEMARKCN COMPANY LIMITED

Block A, 4/F., Granville Building,

14 Granville Road,

Tsim Sha Tsui, Kowloon, Hong Kong



[11] 2118682.0

[15] 15-09-2021

[51] Cl. 28-03

[54] 化妝品容器

Cosmetic container

[73] AMOREPACIFIC CORPORATION

100, Hangang-daero,

Yongsan-gu, Seoul,

Korea, Republic of

[74] TRADEMARKCN COMPANY LIMITED

Block A, 4/F., Granville Building,

14 Granville Road,

Tsim Sha Tsui, Kowloon, Hong Kong



-
- [11] 2118683.2
[15] 15-09-2021
[30] 18-03-2021 / JP / 005548 of 2021
[51] Cl. 6-11
[54] 量度手、手指或手腕的毯
Mat for measuring hand, finger or wrist
[73] ZOZO, INC.
1-15-16, Midori-cho, Inage-ku,
Chiba-shi, Chiba 263-0023,
Japan
[74] SPRUSON & FERGUSON (HONG KONG) LIMITED
5001 Hopewell Centre,
183 Queen's Road East,
Wan Chai, Hong Kong

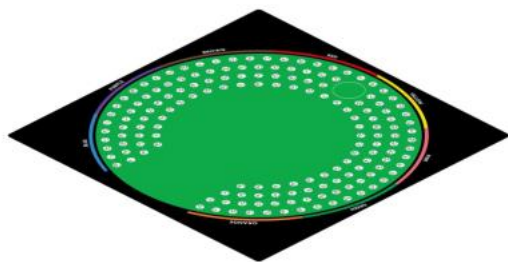

-
- [11] 2118690.7M001
[15] 16-09-2021
[30] 25-03-2021 / MX, RU, SG, CH, TR, GB, VN, EU, KR / DM/214 001
[51] Cl. 29-02
[54] 防護口罩
Protective face mask

[73] HeiQ Materials AG
Rütistrasse 12,
8952 Schlieren,
Switzerland

[74] WILKINSON & GRIST
6th Floor, Prince's Building,
Chater Road,
Hong Kong



[11] 2118690.7M002

[15] 16-09-2021

[30] 25-03-2021 / MX, RU, SG, CH, TR, GB, VN, EU, KR / DM/214 001

[51] Cl. 29-02

[54] 防護口罩

Protective face mask

[73] HeiQ Materials AG
Rütistrasse 12,
8952 Schlieren,
Switzerland

[74] WILKINSON & GRIST
6th Floor, Prince's Building,
Chater Road,
Hong Kong



[11] 2118696.0M001

[15] 16-09-2021

[30] 17-03-2021 / CN / 202130144016.0

[51] Cl. 12-11

[54] 擋泥板

Mud guard

[73] 北京小米移動軟件有限公司

Beijing Xiaomi Mobile Software Co., Ltd.

中國內地

北京市海澱區西二旗中路 33 號院

6 號樓 8 層 018 號

[74] 隆天專利商標代理有限公司

香港

長沙灣青山道 485 號

九龍廣場 10 樓 11 室

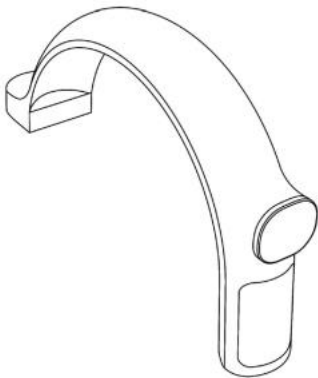

[11] 2118696.0M002

[15] 16-09-2021

[30] 17-03-2021 / CN / 202130144016.0

[51] Cl. 12-11

[54] 擋泥板

Mud guard

[73] 北京小米移動軟件有限公司

Beijing Xiaomi Mobile Software Co., Ltd.

中國內地

北京市海澱區西二旗中路 33 號院

6 號樓 8 層 018 號

[74] 隆天專利商標代理有限公司

香港

長沙灣青山道 485 號

九龍廣場 10 樓 11 室

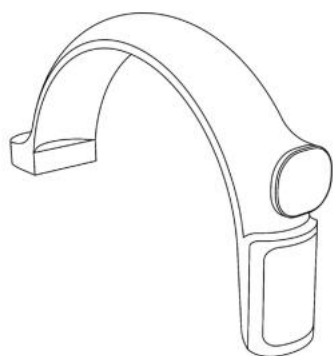

[11] 2118701.2

[15] 17-09-2021

[51] Cl. 3-01

[54] 行李箱

Luggage

[73] 新秀麗 IP 控股有限責任公司

Samsonite IP Holdings S.à r.l.

13-15 avenue de la Liberté,

L-1931 Luxembourg,

Luxembourg

[74] WILKINSON & GRIST

6th Floor, Prince's Building

Chater Road,

Hong Kong

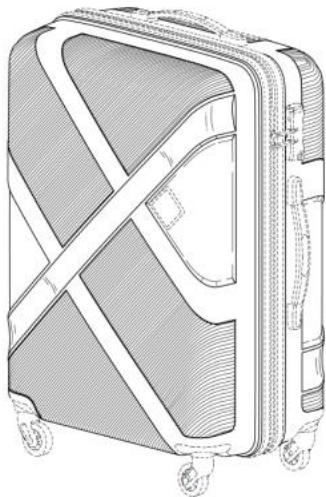

[11] 2118703.6

[15] 17-09-2021

[30] 17-03-2021 / CN / 202130143613.1

[51] Cl. 14-06

[54] 自拍杆

Selfie Stick

[73] 北京小米移動軟件有限公司

Beijing Xiaomi Mobile Software Co., Ltd.

中國內地

北京市海澱區西二旗中路 33 號院

6 號樓 8 層 018 號

[74] 隆天專利商標代理有限公司

香港

長沙灣青山道 485 號

九龍廣場 10 樓 11 室

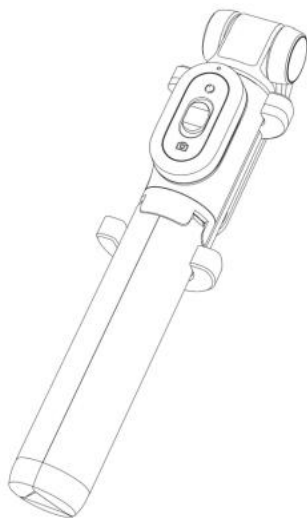

[11] 2118705.1

[15] 17-09-2021

[51] Cl. 29-02

[54] 口罩
Mask

[73] 姿曼國際有限公司
Giman International Ltd
香港九龍
旺角廣東道 1123 號
福安工廠大廈 2 樓 B 室

[74] 卓遠知識產權有限公司
香港上環
禧利街 27 號
富輝商業中心 10 樓



[11] 2118706.3M001

[15] 17-09-2021

[51] Cl. 21-01

[54] 積木
Building block

[73] 佳樂專有限公司
Kalos Blocks Company Limited
9/F., Southeast Industrial Building,
611-619 Castle Peak Road,
Tsuen Wan, Hong Kong

[74] HONG KONG INTELLECTUAL PROPERTY ADVISORY SERVICE LIMITED
1/F., Fuk Wo Industrial Building,
5 Sheung Hei Street,
San Po Kong, Kowloon, Hong Kong

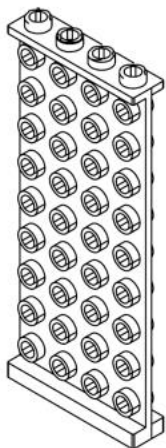

[11] 2118706.3M002

[15] 17-09-2021

[51] Cl. 21-01

[54] 積木

Building block

[73] 佳樂專有限公司

Kalos Blocks Company Limited
9/F., Southeast Industrial Building,
611-619 Castle Peak Road,
Tsuen Wan, Hong Kong

[74] HONG KONG INTELLECTUAL PROPERTY ADVISORY SERVICE LIMITED

1/F., Fuk Wo Industrial Building,
5 Sheung Hei Street,
San Po Kong, Kowloon, Hong Kong

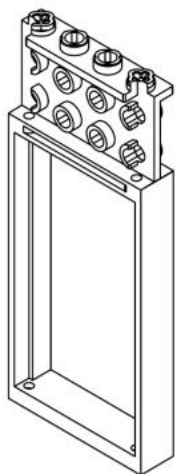

[11] 2118706.3M003

[15] 17-09-2021

[51] Cl. 21-01

[54] 積木

Building block

[73] 佳樂專有限公司

Kalos Blocks Company Limited

9/F., Southeast Industrial Building,

611-619 Castle Peak Road,

Tsuen Wan, Hong Kong

[74] HONG KONG INTELLECTUAL PROPERTY ADVISORY SERVICE LIMITED

1/F., Fuk Wo Industrial Building,

5 Sheung Hei Street,

San Po Kong, Kowloon, Hong Kong

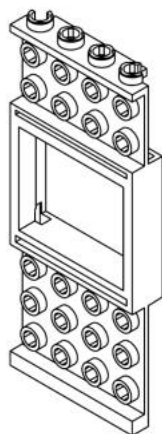

[11] 2118706.3M004

[15] 17-09-2021

[51] Cl. 21-01

[54] 積木

Building block

[73] 佳樂專有限公司

Kalos Blocks Company Limited

9/F., Southeast Industrial Building,

611-619 Castle Peak Road,

Tsuen Wan, Hong Kong

[74] HONG KONG INTELLECTUAL PROPERTY ADVISORY SERVICE LIMITED

1/F., Fuk Wo Industrial Building,

5 Sheung Hei Street,

San Po Kong, Kowloon, Hong Kong

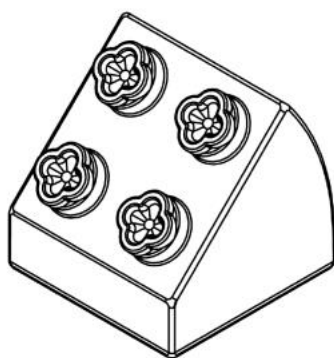

[11] 2118706.3M005

[15] 17-09-2021

[51] Cl. 21-01

[54] 積木

Building block

[73] 佳樂專有限公司

Kalos Blocks Company Limited
9/F., Southeast Industrial Building,
611-619 Castle Peak Road,
Tsuen Wan, Hong Kong

[74] HONG KONG INTELLECTUAL PROPERTY ADVISORY SERVICE LIMITED

1/F., Fuk Wo Industrial Building,
5 Sheung Hei Street,
San Po Kong, Kowloon, Hong Kong

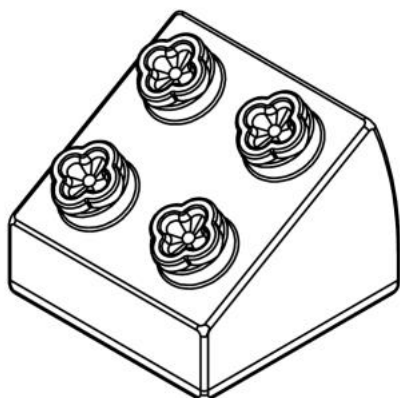

[11] 2118707.5M001

[15] 17-09-2021

[30] 16-04-2021 / CA, AM, AZ, BZ, BA, GE, LI, MK, MD, MC, MN, ME,
MA, NO, OM, SG, CH, TN, TR, UA, GB, EU, AL, KG / DM/213 804

[51] Cl. 11-01

[54] 項鍊

Necklace

[73] Harry Winston SA

Chemin du Tourbillon 8,
CH-1228 Plan-les-Ouates,
Switzerland

[74] SPRUSON & FERGUSON (HONG KONG) LIMITED

5001 Hopewell Centre,
183 Queen's Road East,
Wan Chai, Hong Kong



[11] 2118707.5M002

[15] 17-09-2021

[30] 16-04-2021 / CA, AM, AZ, BZ, BA, GE, LI, MK, MD, MC, MN, ME,
MA, NO, OM, SG, CH, TN, TR, UA, GB, EU, AL, KG / DM/213 804

[51] Cl. 11-01

[54] 手鏈

Bracelet

[73] Harry Winston SA

Chemin du Tourbillon 8,
CH-1228 Plan-les-Ouates,
Switzerland

[74] SPRUSON & FERGUSON (HONG KONG) LIMITED

5001 Hopewell Centre,
183 Queen's Road East,
Wan Chai, Hong Kong



[11] 2118707.5M003

- [15] 17-09-2021
- [30] 16-04-2021 / CA, AM, AZ, BZ, BA, GE, LI, MK, MD, MC, MN, ME, MA, NO, OM, SG, CH, TN, TR, UA, GB, EU, AL, KG / DM/213 804
- [51] Cl. 11-01
- [54] 耳環
Earrings
- [73] Harry Winston SA
Chemin du Tourbillon 8,
CH-1228 Plan-les-Ouates,
Switzerland
- [74] SPRUSON & FERGUSON (HONG KONG) LIMITED
5001 Hopewell Centre,
183 Queen's Road East,
Wan Chai, Hong Kong



-
- [11] 2118707.5M004
- [15] 17-09-2021
- [30] 16-04-2021 / CA, AM, AZ, BZ, BA, GE, LI, MK, MD, MC, MN, ME, MA, NO, OM, SG, CH, TN, TR, UA, GB, EU, AL, KG / DM/213 804
- [51] Cl. 11-01
- [54] 耳環
Earrings
- [73] Harry Winston SA
Chemin du Tourbillon 8,
CH-1228 Plan-les-Ouates,
Switzerland
- [74] SPRUSON & FERGUSON (HONG KONG) LIMITED
5001 Hopewell Centre,
183 Queen's Road East,
Wan Chai, Hong Kong



[11] 2118707.5M005

[15] 17-09-2021

[30] 16-04-2021 / CA, AM, AZ, BZ, BA, GE, LI, MK, MD, MC, MN, ME, MA, NO, OM, SG, CH, TN, TR, UA, GB, EU, AL, KG / DM/213 804

[51] Cl. 11-01

[54] 指環
Ring

[73] Harry Winston SA
Chemin du Tourbillon 8,
CH-1228 Plan-les-Ouates,
Switzerland

[74] SPRUSON & FERGUSON (HONG KONG) LIMITED
5001 Hopewell Centre,
183 Queen's Road East,
Wan Chai, Hong Kong



[11] 2118707.5M006

[15] 17-09-2021

[30] 16-04-2021 / CA, AM, AZ, BZ, BA, GE, LI, MK, MD, MC, MN, ME, MA, NO, OM, SG, CH, TN, TR, UA, GB, EU, AL, KG / DM/213 804

[51] Cl. 11-01

[54] 手鏈

Bracelet

[73] Harry Winston SA

Chemin du Tourbillon 8,
CH-1228 Plan-les-Ouates,
Switzerland

[74] SPRUSON & FERGUSON (HONG KONG) LIMITED

5001 Hopewell Centre,
183 Queen's Road East,
Wan Chai, Hong Kong



[11] 2118708.7M001

[15] 17-09-2021

[51] Cl. 21-01

[54] 積木

Building block

[73] 佳樂專有限公司

Kalos Blocks Company Limited
9/F., Southeast Industrial Building,
611-619 Castle Peak Road,
Tsuen Wan, Hong Kong

[74] HONG KONG INTELLECTUAL PROPERTY ADVISORY SERVICE LIMITED

1/F., Fuk Wo Industrial Building,
5 Sheung Hei Street,
San Po Kong, Kowloon, Hong Kong

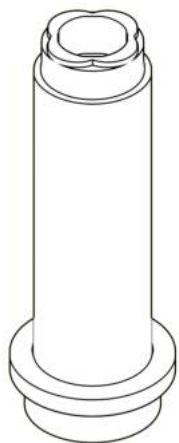

[11] 2118708.7M002

[15] 17-09-2021

[51] Cl. 21-01

[54] 積木

Building block

[73] 佳樂專有限公司

Kalos Blocks Company Limited
9/F., Southeast Industrial Building,
611-619 Castle Peak Road,
Tsuen Wan, Hong Kong

[74] HONG KONG INTELLECTUAL PROPERTY ADVISORY SERVICE LIMITED

1/F., Fuk Wo Industrial Building,
5 Sheung Hei Street,
San Po Kong, Kowloon, Hong Kong

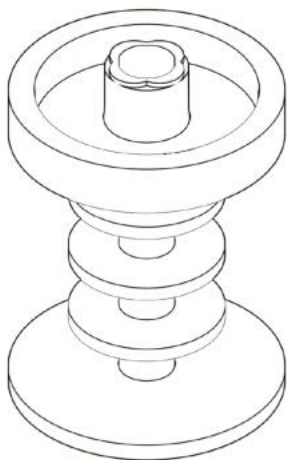

[11] 2118708.7M003

[15] 17-09-2021

[51] Cl. 21-01

[54] 人偶積木

Figure block

[73] 佳樂專有限公司

Kalos Blocks Company Limited

9/F., Southeast Industrial Building,

611-619 Castle Peak Road,

Tsuen Wan, Hong Kong

[74] HONG KONG INTELLECTUAL PROPERTY ADVISORY SERVICE LIMITED

1/F., Fuk Wo Industrial Building,

5 Sheung Hei Street,

San Po Kong, Kowloon, Hong Kong

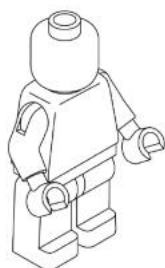

[11] 2118709.9

[15] 17-09-2021

[30] 19-03-2021 / CN / 202130150477.9

[51] Cl. 23-07

[54] 座便器

Toilet

[73] 吉博力國際股份公司

Geberit International AG

Schachenstrasse 77,

CH-8645 Jona,

Switzerland

[74] BARRON & YOUNG INTELLECTUAL PROPERTY LIMITED

Suite 617, Lakeside 2,

No. 10 Science Park West Avenue,

Hong Kong Science Park,

Shatin, N.T., Hong Kong



[11] 2118711.3M001

[15] 18-09-2021

[30] 26-03-2021 / CN / 202130168856.0

[51] Cl. 14-03

[54] 手機

Mobile phone

[73] 榮耀終端有限公司

HONOR DEVICE CO., LTD.

中國內地

廣東省深圳市福田區香蜜湖街道紅荔西路 8089 號

深業中城 6 號樓 A 單元 3401, 518040

[74] 集佳知識產權有限公司

香港九龍

旺角洗衣街 39-55 號

金雞廣場 12 層 1201 室

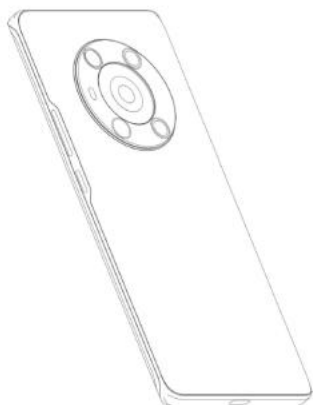

[11] 2118711.3M002

[15] 18-09-2021

[30] 26-03-2021 / CN / 202130168856.0

[51] Cl. 14-03

[54] 手機

Mobile phone

[73] 榮耀終端有限公司

HONOR DEVICE CO., LTD.

中國內地

廣東省深圳市福田區香蜜湖街道紅荔西路 8089 號

深業中城 6 號樓 A 單元 3401, 518040

[74] 集佳知識產權有限公司

香港九龍

旺角洗衣街 39-55 號

金雞廣場 12 層 1201 室

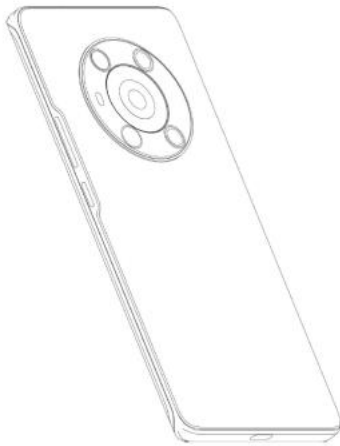

[11] 2118711.3M003

[15] 18-09-2021

[30] 26-03-2021 / CN / 202130168856.0

[51] C1. 14-03

[54] 手機

Mobile phone

[73] 榮耀終端有限公司

HONOR DEVICE CO., LTD.

中國內地

廣東省深圳市福田區香蜜湖街道紅荔西路 8089 號

深業中城 6 號樓 A 單元 3401, 518040

[74] 集佳知識產權有限公司

香港九龍

旺角洗衣街 39-55 號

金雞廣場 12 層 1201 室

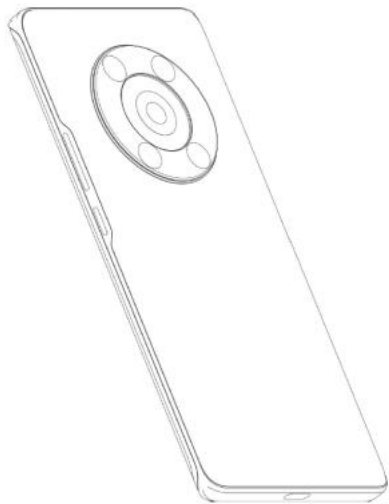

[11] 2118711.3M004

[15] 18-09-2021

[30] 26-03-2021 / CN / 202130168856.0

[51] Cl. 14-03

[54] 手機

Mobile phone

[73] 榮耀終端有限公司

HONOR DEVICE CO., LTD.

中國內地

廣東省深圳市福田區香蜜湖街道紅荔西路 8089 號

深業中城 6 號樓 A 單元 3401, 518040

[74] 集佳知識產權有限公司

香港九龍

旺角洗衣街 39-55 號

金雞廣場 12 層 1201 室

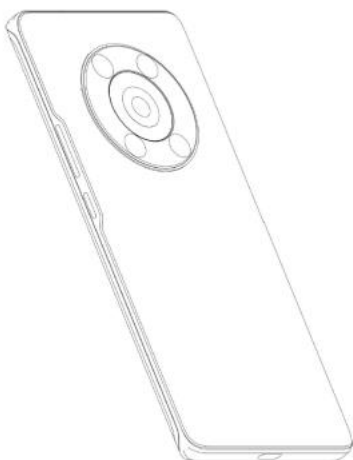

- [11] 2118711.3M005
[15] 18-09-2021
[30] 26-03-2021 / CN / 202130168856.0
[51] Cl. 14-03
[54] 手機
Mobile phone
[73] 榮耀終端有限公司
HONOR DEVICE CO., LTD.
中國內地
廣東省深圳市福田區香蜜湖街道紅荔西路 8089 號
深業中城 6 號樓 A 單元 3401, 518040
[74] 集佳知識產權有限公司
香港九龍
旺角洗衣街 39-55 號
金雞廣場 12 層 1201 室

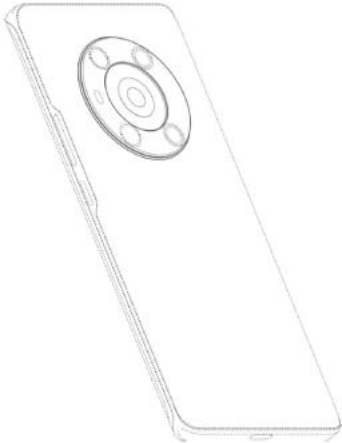

-
- [11] 2118711.3M006
[15] 18-09-2021
[30] 26-03-2021 / CN / 202130168856.0
[51] Cl. 14-03
[54] 手機
Mobile phone
[73] 榮耀終端有限公司
HONOR DEVICE CO., LTD.
中國內地
廣東省深圳市福田區香蜜湖街道紅荔西路 8089 號
深業中城 6 號樓 A 單元 3401, 518040
[74] 集佳知識產權有限公司
香港九龍

旺角洗衣街 39-55 號
金雞廣場 12 層 1201 室

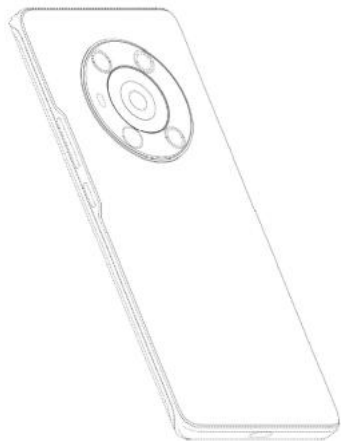

[11] 2118711.3M007

[15] 18-09-2021

[30] 26-03-2021 / CN / 202130168856.0

[51] Cl. 14-03

[54] 手機

Mobile phone

[73] 榮耀終端有限公司

HONOR DEVICE CO., LTD.

中國內地

廣東省深圳市福田區香蜜湖街道紅荔西路 8089 號

深業中城 6 號樓 A 單元 3401, 518040

[74] 集佳知識產權有限公司

香港九龍

旺角洗衣街 39-55 號

金雞廣場 12 層 1201 室

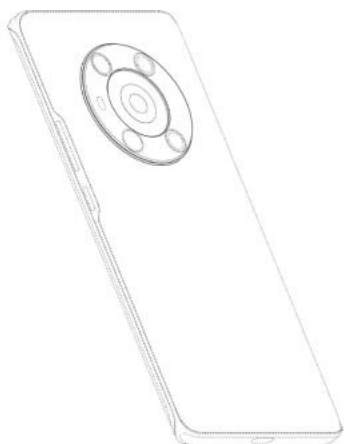

[11] 2118711.3M008

[15] 18-09-2021

[30] 26-03-2021 / CN / 202130168856.0

[51] Cl. 14-03

[54] 手機

Mobile phone

[73] 榮耀終端有限公司

HONOR DEVICE CO., LTD.

中國內地

廣東省深圳市福田區香蜜湖街道紅荔西路 8089 號

深業中城 6 號樓 A 單元 3401, 518040

[74] 集佳知識產權有限公司

香港九龍

旺角洗衣街 39-55 號

金雞廣場 12 層 1201 室

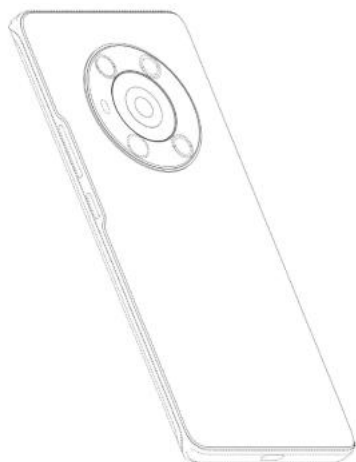

[11] 2118711.3M009

[15] 18-09-2021

[30] 26-03-2021 / CN / 202130168856.0

[51] Cl. 14-03

[54] 手機

Mobile phone

[73] 榮耀終端有限公司

HONOR DEVICE CO., LTD.

中國內地

廣東省深圳市福田區香蜜湖街道紅荔西路 8089 號

深業中城 6 號樓 A 單元 3401, 518040

[74] 集佳知識產權有限公司

香港九龍

旺角洗衣街 39-55 號
金雞廣場 12 層 1201 室



[11] 2118711.3M010

[15] 18-09-2021

[30] 26-03-2021 / CN / 202130168856.0

[51] Cl. 14-03

[54] 手機

Mobile phone

[73] 榮耀終端有限公司

HONOR DEVICE CO., LTD.

中國內地

廣東省深圳市福田區香蜜湖街道紅荔西路 8089 號

深業中城 6 號樓 A 單元 3401, 518040

[74] 集佳知識產權有限公司

香港九龍

旺角洗衣街 39-55 號

金雞廣場 12 層 1201 室





香港特別行政區政府知識產權署外觀設計註冊處

The Government of the Hong Kong Special Administrative Region

Designs Registry, Intellectual Property Department

根據註冊外觀設計條例第 28 條，下列註冊外觀設計因未繳續期費而停止有效。

各組記項按註冊外觀設計停止有效日期及註冊編號先後次序排列。

Registered designs ceased through non-payment of renewal fees under section 28 of the Registered Designs Ordinance. Entries are listed below under their expiry dates.

23-09-2021 - 12-10-2021

23-09-2021	0602501.1M002	1601847.5
0111444.4	0602502.3	1601848.7
	0602503.5	1601849.9
25-09-2021	0602507.4	1601853.7M001
0602475.4	0602508.6	1601853.7M002
0602477.8	0602513.6	1601853.7M003
0602478.0	0602514.8	1601855.2M005
1101648.8	1601832.3M001	1601856.4M001
1101650.2	1601832.3M002	1601856.4M002
1101654.0M003	1601832.3M003	1601856.4M003
1101655.3	1601832.3M004	1601856.4M004
1601817.2	1601836.2	1700627.9
1601819.6	1601837.4	
1601822.2		29-09-2021
1601823.4	28-09-2021	1101681.7M001
1601824.6	0602531.4	1101681.7M002
	0602535.3	1101681.7M003
26-09-2021	0602539.1M001	1101681.7M004
0602496.8M001	0602539.1M002	1101681.7M005
0602497.0M001	0602539.1M003	1101681.7M006
0602497.0M002	0602539.1M004	1101681.7M007
1101660.3M001	0602542.7	1101681.7M008
1101660.3M002	1601839.8M001	1101681.7M009
1101660.3M003	1601839.8M002	1101682.9M001
1101660.3M004	1601840.0M001	1101682.9M002
1101661.5M001	1601840.0M002	1601857.6
1101661.5M002	1601841.2M001	1601859.0
1601827.3	1601841.2M002	1601861.4
1601830.9	1601842.4M001	1601865.3M001
	1601842.4M002	1601865.3M002
27-09-2021	1601843.6	1601865.3M003
0602500.9M001	1601844.8M001	1601865.3M004
0602500.9M002	1601844.8M002	1601865.3M005
0602500.9M003	1601846.3	1601865.3M006

1601865.3M007	1601896.8M003
1601865.3M008	1601899.4
1601865.3M009	
1601865.3M010	10-10-2021
1601865.3M011	1101763.1M001
1601865.3M012	1601902.2
1601865.3M013	1601903.4
1601865.3M014	1601906.1
1601865.3M015	1601907.3
1601865.3M016	1601908.5M001
1601865.3M017	1601908.5M002
1601865.3M018	1601909.7M001
1601867.7	1601909.7M002
1601869.1	
02-10-2021	11-10-2021
0602555.5	1101767.0
1101689.4	1601912.3
1101691.8	1601913.5
1601871.5	1601914.7
1601874.1M001	1601915.0
	1601917.4M001
	1601917.4M002
03-10-2021	1601917.4M003
1101700.9	1601917.4M004
1101704.7	1601917.4M005
1101705.0	1601918.6M001
1101706.2	1601918.6M002
1101707.4M001	1601920.0
1101707.4M002	1601922.4
1601875.4	1601924.8
1601876.6	1601925.1
1601877.8	1601926.3
	1601928.7
04-10-2021	1601930.1
1601886.7	1601931.3
1601887.9	1601932.5
	1601933.7
05-10-2021	12-10-2021
1601889.3	1101777.1
1601890.5	1101778.3
1601891.7	1101781.9M002
1601892.9M001	1601936.4M001
1601892.9M002	1601936.4M002
1601892.9M003	1601936.4M003
	1601936.4M004
06-10-2021	
1101738.9	
1601896.8M002	



香港特別行政區政府知識產權署外觀設計註冊處

The Government of the Hong Kong Special Administrative Region

Designs Registry, Intellectual Property Department

根據註冊外觀設計規則第 31 條刪除的註冊外觀設計。各組記項按註冊外觀設計刪除日期及註冊編號先後次序排列。

Registered designs removed under section 31 of the Registered Designs Rules. Entries are listed below under their removal dates.

22-10-2021 - 27-10-2021

22-10-2021	0600832.0	1100579.0M001
0110439.3	0600833.2	1100579.0M002
0110446.8M001	0600834.4	1100579.0M003
0110447.0M001	0600836.9	1100579.0M004
0110453.2	0600837.1	1100579.0M005
0110467.2	0600838.3	1100584.0
0110468.4	0600841.9	1600478.0
0110486.2	0600842.1	1600489.3
0110490.0M001	0600843.3	1600531.4
0600729.2	0600878.7	1600534.0
0600730.4	0600879.9	1600535.3
0600736.7	0600891.4	1600538.9M006
0600737.9	1100475.9M001	1600538.9M007
0600738.1	1100475.9M002	1600539.1
0600759.5	1100482.3	1600540.3
0600760.7	1100486.2	1600541.5M001
0600761.9	1100488.6	1600541.5M002
0600775.9	1100493.6M001	1600542.7
0600776.1	1100493.6M002	1600544.1
0600792.4	1100493.6M003	1600545.4M001
0600794.8	1100495.1	1600545.4M002
0600795.1	1100507.9	1600545.4M003
0600796.3	1100508.1M002	1600546.6
0600797.5	1100515.6	1600547.8
0600798.7	1100516.8	1600548.0
0600799.9	1100517.0	1600552.8M001
0600800.3	1100533.3	1600552.8M002
0600804.1	1100543.4	1600552.8M003
0600808.0M001	1100544.6	1600552.8M004
0600808.0M002	1100548.5	1600552.8M005
0600826.8	1100552.3	1600552.8M006
0600827.0	1100559.8	1600552.8M007
0600829.4	1100568.7M001	1600552.8M008
0600830.6	1100568.7M002	1600552.8M009

1600552.8M010	1600573.2M003	1600637.9M002
1600552.8M011	1600573.2M004	1600638.1
1600552.8M012	1600573.2M005	1600639.3
1600552.8M013	1600579.5M001	1600640.5
1600552.8M014	1600579.5M002	1600641.7M001
1600552.8M015	1600581.9M003	1600643.1M001
1600552.8M016	1600581.9M004	1600643.1M002
1600552.8M017	1600581.9M006	1600644.3M001
1600552.8M018	1600581.9M008	1600644.3M002
1600552.8M019	1600581.9M010	1600645.6M001
1600552.8M020	1600584.5	1600645.6M002
1600552.8M021	1600586.0	1601529.1
1600552.8M022	1600587.2	1601530.3
1600552.8M023	1600588.4	1601709.3
1600552.8M024	1600589.6	
1600552.8M025	1600592.2	24-10-2021
1600552.8M026	1600595.9	0600923.3
1600552.8M027	1600606.4M001	
1600552.8M028	1600606.4M002	25-10-2021
1600553.0M001	1600606.4M003	0110540.8M003
1600553.0M002	1600606.4M004	1100596.6
1600554.2M001	1600613.8M003	1600650.6
1600554.2M002	1600613.8M004	1600651.8
1600554.2M003	1600614.0	
1600554.2M004	1600616.5	26-10-2021
1600554.2M005	1600617.7	0600950.0
1600554.2M006	1600618.9M001	0600952.4
1600554.2M007	1600618.9M002	0600953.6
1600554.2M008	1600618.9M003	0600954.8
1600555.5M001	1600618.9M004	1100607.1M001
1600555.5M002	1600618.9M005	1100608.3M001
1600558.1	1600619.1	1100608.3M002
1600563.1	1600621.5M001	1100608.3M003
1600564.3	1600621.5M002	1100608.3M004
1600565.6M001	1600622.7M001	1100608.3M005
1600565.6M002	1600622.7M002	1600653.2
1600565.6M003	1600622.7M003	1600654.4M001
1600565.6M004	1600622.7M004	1600654.4M002
1600566.8M001	1600622.7M005	1600655.7
1600566.8M002	1600622.7M006	
1600566.8M003	1600622.7M007	27-10-2021
1600566.8M004	1600626.6	0600979.1
1600566.8M005	1600630.4	1100610.7
1600566.8M006	1600631.6	1100612.1
1600571.8	1600632.8	1100615.8
1600572.0	1600635.5	1100616.0
1600573.2M001	1600636.7	1100623.4
1600573.2M002	1600637.9M001	1100624.6

1100625.9

1100626.1

1100627.3

1100628.5

1600672.2



香港特別行政區政府知識產權署外觀設計註冊處

The Government of the Hong Kong Special Administrative Region

Designs Registry, Intellectual Property Department

根據註冊外觀設計條例第 45 條，撤銷註冊

Revocation of registration under section 45 of the Registered Designs Ordinance

依據香港特別行政區高等法院原訟法庭雜項法律程序訴訟編號 2021 年第 337 號在 29.09.2021 作出的命令，撤銷外觀設計註冊編號 0802778.9M001, 0802778.9M002, 0802778.9M003, 0802857.7M001。

By an Order of the Court of the First Instance of the High Court of the Hong Kong Special Administrative Region dated 29.09.2021 in Miscellaneous Proceedings No. 337 of 2021, design registration nos. 0802778.9M001, 0802778.9M002, 0802778.9M003, 0802857.7M001 were revoked.