

香港知識產權公報

Hong Kong Intellectual Property Journal

2020 年 3 月 13 日

13 March 2020

目錄 Contents

根據註冊外觀設計條例第 25 條註冊的外觀設計

Designs Registered under section 25 of the Registered Designs Ordinance

按註冊編號排列

Arranged by Registration Number

根據註冊外觀設計條例(第 522 章)公布的其他公告

Other Notices Published under the Registered Designs Ordinance (Cap. 522)

根據註冊外觀設計條例第 76 條, 更正已提交文件中的錯誤

Correction of errors in filed documents under section 76 of the Registered Designs Ordinance

以下事項沒有記錄

No Records for the Following Matters

根據註冊外觀設計條例第 28 條, 註冊外觀設計因未繳續期費而停止有效

Registered designs ceased through non-payment of renewal fees under section 28 of the Registered Designs Ordinance

根據註冊外觀設計條例第 30 條放棄的外觀設計的註冊

Surrender of Registration of Design under section 30 of the Registered Designs Ordinance

根據註冊外觀設計規則第 31 條刪除的註冊外觀設計

Registered designs removed under section 31 of the Registered Designs Rules

根據註冊外觀設計規則第 37 條，向處長作出轉介

Reference to Registrar under section 37 of the Registered Designs Rules

根據註冊外觀設計條例第 45 條，撤銷註冊

Revocation of Registration under section 45 of the Registered Designs Ordinance

根據註冊外觀設計規則第 46 條，向法院作出轉介

Reference to Court under section 46 of the Registered Designs Rules

根據註冊外觀設計規則第 63 條對不符合規定之處作出糾正

Rectification of Irregularities under section 63 of the Registered Designs Rules

根據註冊外觀設計條例第 66 條，糾正註冊紀錄冊

Rectification of Register under section 66 of the Registered Designs Ordinance

根據註冊外觀設計條例第 67 條 更正註冊紀錄冊內的錯誤

Correction of errors in Register under section 67 of the Registered Designs Ordinance

根據註冊外觀設計條例第 67 及 76 條，更正註冊紀錄冊內及已提交文件中的錯誤

Correction of Errors in Register and in Filed Documents under sections 67 and 76 of the Registered Designs Ordinance

勘誤

Corrigendum

註冊外觀設計公告註釋

Notes on advertisements of registration of designs

方括號表示下列資料：

Square brackets indicate the following data：

[11] 註冊編號 Registration number / 聯合王國註冊編號 United Kingdom registration number

[15] 註冊日期 Registration date / 當作註冊日期 Deemed registration date / 聯合王國註冊日期 United Kingdom registration date

[17] 註冊有效期屆滿日期 Expiry date of the period of registration

[22] 提交日期 Filing date / 當作提交日期 Deemed filing date / 聯合王國提交日期 United Kingdom filing date

[30] 聲稱享有的優先權（提交日期 / 巴黎公約國或世界貿易組織成員 / 申請編號） Priority claimed (filing date / Paris Convention country or WTO member / application number)

[51] 國際外觀設計分類號（洛迦諾分類號） International Classification of designs (Locarno Classification)

[54] 物品 Article

[55] 外觀設計的表述 Representation of the design

[62] 分開前的申請編號及提交日期 Application number before division and filing date

[66] 過往註冊的聯繫外觀設計註冊編號 / 日期 Registration No. / Date of Previous Registration for Association

[72] 設計人 Designer

[73] 擁有人姓名和地址 Name and address of the owner

[74] 代理人 Agent / 送達地址 Address for service



香港特別行政區政府知識產權署外觀設計註冊處

The Government of the Hong Kong Special Administrative Region

Designs Registry, Intellectual Property Department

根據註冊外觀設計條例第 25 條註冊的外觀設計

Designs registered under section 25 of the Registered Designs Ordinance

按註冊編號排列

Arranged by Registration Number

[11] 1802507.8

[15] 20-12-2018

[30] 20-06-2018 / FR / 2018-2992

[51] Cl. 2-04

[54] 鞋

Shoe

[73] LOUIS VUITTON MALLETIER

2, rue du Pont-Neuf 75001 Paris,

FRANCE

[74] BAKER & MCKENZIE

14th Floor, One Taikoo Place

979 King's Road, Quarry Bay

HONG KONG



[11] 1802508.0

[15] 20-12-2018

[30] 20-06-2018 / FR / 2018-2992

[51] Cl. 2-04

[54] 鞋

Shoe

[73] LOUIS VUITTON MALLETIER
2, rue du Pont-Neuf 75001 Paris,
FRANCE

[74] BAKER & MCKENZIE
14th Floor, One Taikoo Place
979 King's Road, Quarry Bay
HONG KONG



[11] 1802509.2

[15] 20-12-2018

[30] 20-06-2018 / FR / 2018-2992

[51] Cl. 2-04

[54] 鞋
Shoe

[73] LOUIS VUITTON MALLETIER
2, rue du Pont-Neuf 75001 Paris,
FRANCE

[74] BAKER & MCKENZIE
14th Floor, One Taikoo Place
979 King's Road, Quarry Bay
HONG KONG



[11] 1913354.5

[15] 02-04-2019

[30] 02-10-2018 / FR / 2018-4410

[51] Cl. 3-01

[54] 袋

Bag

[73] LOUIS VUITTON MALLETIER

2 rue du Pont-Neuf

75001 Paris

FRANCE

[74] BAKER & MCKENZIE

14th Floor, One Taikoo Place

979 King's Road, Quarry Bay

HONG KONG



[11] 1913708.8

[15] 22-05-2019

[30] 12-04-2019 / CN / 201930165126.8

[51] Cl. 28-03

[54] 震動雙頭按摩槍

Massage gun with twin vibration head

[73] Yell Group Limited

香港

長沙灣永康街 63 號

Global Gateway Tower 15 樓 5 室

[74] Yell Group Limited Ms. Susanne Luk

香港

長沙灣永康街 63 號

Global Gateway Tower 15 樓 5 室

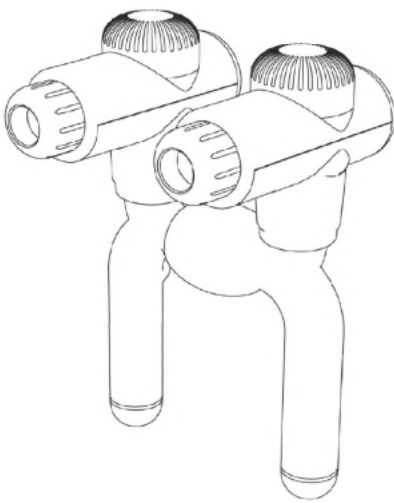

[11] 1913770.8

[15] 29-05-2019

[30] 23-01-2019 / US / 29/677,816

[51] Cl. 10-04

[54] 體重秤和浴墊的組合

COMBINATION WEIGHT SCALE AND BATH MAT

[73] William Huckestein

5963 Olivas Park Drive, Suite F

Ventura CA 93003

UNITED STATES

Bryan Kim

5963 Olivas Park Drive, Suite F

Ventura CA 93003

UNITED STATES

[74] IVAN WONG IP LIMITED
Unit 1406, 14th Floor, The Broadway,
54-62 Lockhart Road, Wanchai,
HONG KONG

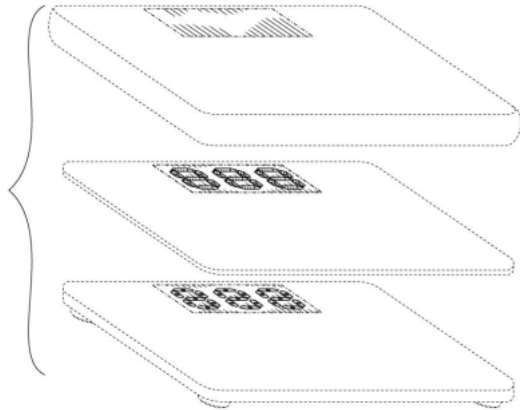

[11] 1914149.2M001

[15] 08-07-2019

[51] Cl. 2-07

[54] 拉鏈上的拉鏈牌
Puller of slide fastener

[73] 合眾(中國行信)有限公司
POP UP Company Limited
香港
九龍荔枝角
永康街 20 號 5 字樓

[74] POP UP Company Limited
香港
九龍荔枝角
永康街 20 號 5 字樓



[11] 1914149.2M002

[15] 08-07-2019

[51] Cl. 2-07

[54] 拉鏈上的拉鏈牌

Puller of slide fastener

[73] 合眾(中國行信)有限公司

POP UP Company Limited

香港

九龍荔枝角

永康街 20 號 5 字樓

[74] POP UP Company Limited

香港

九龍荔枝角

永康街 20 號 5 字樓



[11] 1914216.5M001

[15] 15-07-2019

[30] 15-01-2019 / CN / 201930020643.6

[51] Cl. 14-03

[54] 手機

Mobile phone

[73] HUAWEI DEVICE CO., LTD.

B2-5 OF NANFANG FACTORY, NO.2 OF XINCHENG ROAD, SONGSHAN LAKE
SCIENCE

AND TECHNOLOGY INDUSTRIAL ZONE, DONGGUAN, GUANGDONG 523808,
CHINA

[74] GLOBAL IP AGENT COMPANY LIMITED

9/F., GOODWILL INDUSTRIAL BUILDING,
36-44 PAK TIN PAR STREET, TSUEN WAN,
HONG KONG



[11] 1914216.5M002

[15] 15-07-2019

[30] 15-01-2019 / CN / 201930020643.6

[51] Cl. 14-03

[54] 手機

Mobile phone

[73] HUAWEI DEVICE CO., LTD.

B2-5 OF NANFANG FACTORY, NO.2 OF XINCHENG ROAD, SONGSHAN LAKE
SCIENCE

AND TECHNOLOGY INDUSTRIAL ZONE, DONGGUAN, GUANGDONG 523808,
CHINA

[74] GLOBAL IP AGENT COMPANY LIMITED

9/F., GOODWILL INDUSTRIAL BUILDING,
36-44 PAK TIN PAR STREET, TSUEN WAN,
HONG KONG



[11] 1914216.5M003

[15] 15-07-2019

[30] 15-01-2019 / CN / 201930020643.6

[51] Cl. 14-03

[54] 手機

Mobile phone

[73] HUAWEI DEVICE CO., LTD.

B2-5 OF NANFANG FACTORY, NO.2 OF XINCHENG ROAD, SONGSHAN LAKE
SCIENCE

AND TECHNOLOGY INDUSTRIAL ZONE, DONGGUAN, GUANGDONG 523808,
CHINA

[74] GLOBAL IP AGENT COMPANY LIMITED

9/F., GOODWILL INDUSTRIAL BUILDING,
36-44 PAK TIN PAR STREET, TSUEN WAN,
HONG KONG



[11] 1914222.7

[15] 15-07-2019

[30] 16-01-2019 / FR / 2019-0216

[51] Cl. 3-01

[54] 袋

Bag

[73] LOUIS VUITTON MALLETTIER

2, rue du Pont-Neuf 75001 Paris,
FRANCE

[74] BAKER & MCKENZIE

14TH FLOOR, ONE TAIKOO PLACE,
979 KING'S ROAD, QUARRY BAY,
HONG KONG

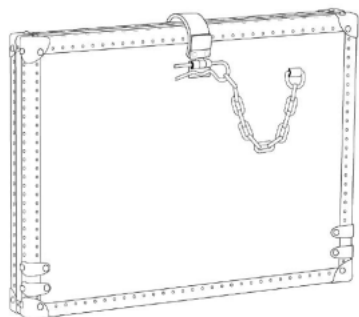

[11] 1914224.1

[15] 15-07-2019

[30] 16-01-2019 / FR / 2019-0216

[51] Cl. 3-01

[54] 袋

Bag

[73] LOUIS VUITTON MALLETTIER

2, rue du Pont-Neuf 75001 Paris,
FRANCE

[74] BAKER & MCKENZIE

14TH FLOOR, ONE TAIKOO PLACE,
979 KING'S ROAD, QUARRY BAY,
HONG KONG

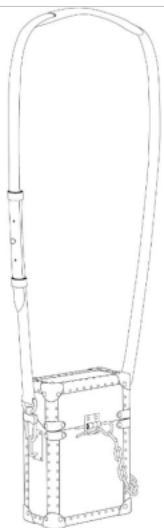

[11] 1914226.6

[15] 15-07-2019

[30] 16-01-2019 / FR / 2019-0216

[51] Cl. 3-01

[54] 袋
Bag

[73] LOUIS VUITTON MALLETIER
2 rue du Pont-Neuf
75001 Paris
FRANCE

[74] BAKER & MCKENZIE
14TH FLOOR, ONE TAIKOO PLACE,
979 KING'S ROAD, QUARRY BAY,
HONG KONG

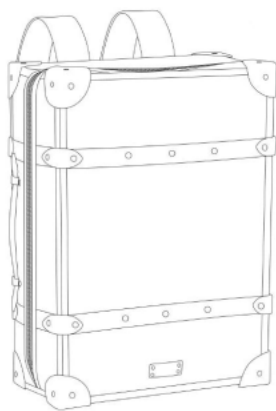

- [11] 1914233.0
[15] 16-07-2019
[30] 30-04-2019 / CN / 201930210756.2
[51] Cl. 14-01
[54] 藍牙音箱
Bluetooth Speaker
[73] 深圳市雲動創想科技有限公司
中國內地
廣東省深圳市南山區粵海街道科技園科技路 9 號螞蟻邦創業加速中心
616 單元
[74] 香港標準知識產權有限公司
香港
中環干諾道中 64 號中華廠商會大廈
21 樓



-
- [11] 1914303.9M001
[15] 23-07-2019
[51] Cl. 3-01
[54] 冷藏蔬菜貯存小袋連包裝”
Vegetable storage pouch for refrigeration with packaging
[73] KAO YA TRADING LIMITED
Flat D, 13/F., Manley House,
86-98 Canton Road, Tsimshatsui,
Kowloon, Hong Kong
[74] KAO YA TRADING LIMITED
Flat D, 13/F., Manley House,
86-98 Canton Road, Tsimshatsui, Kowloon
HONG KONG



[11] 1914303.9M002

[15] 23-07-2019

[51] Cl. 3-01

[54] 冷藏蔬菜貯存小袋連包裝”

Vegetable storage pouch for refrigeration with packaging

[73] KAO YA TRADING LIMITED

Flat D, 13/F., Manley House,
86-98 Canton Road, Tsimshatsui,
Kowloon, Hong Kong

[74] KAO YA TRADING LIMITED

Flat D, 13/F., Manley House,
86-98 Canton Road, Tsimshatsui, Kowloon
HONG KONG



[11] 1914415.7

[15] 08-08-2019

[51] Cl. 27-01

[54] 煙

Cigarette

[73] 游敏燕

中國內地
廣東省東莞市
大朗鎮竹山村 302 號

- [74] 香港銘煥知識產權有限公司
香港
九龍灣宏開道 16 號
德福大廈 13 樓 12 室



-
- [11] 1914429.6
[15] 09-08-2019
[30] 11-04-2019 / CH, GB, EU, JP, KR / DM/201910
[51] Cl. 11-01
[54] 耳環
Earrings
[73] Cartier International AG
Hinterbergstrasse 22
6312 Steinhausen
SWITZERLAND
[74] DEACONS
5th Floor, Alexandra House
Central
HONG KONG

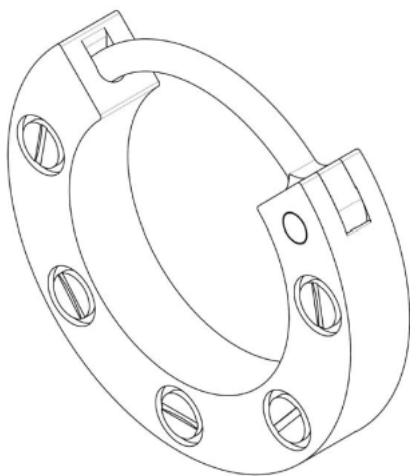

[11] 1914465.2

[15] 15-08-2019

[30] 19-02-2019 / JP / 2019 of 003275

[51] Cl. 28-03

[54] 美容滾輪器

Rollers for cosmetic purposes

[73] 株式會社 MTG

MTG Co., Ltd.

32, HONJIN-DORI 2-CHOME, NAKAMURA-KU, NAGOYA-SHI, AICHI-KEN

453-0041

JAPAN

[74] CHINAHONGKONG IP LIMITED

3011, 30/F, Office Tower, Convention Plaza, 1 Harbour Road

HONG KONG



[11] 1914467.6

[15] 15-08-2019

[30] 15-02-2019 / JP / 2019 of 003089

[51] Cl. 28-03

[54] 噴射器

Fluid emitting device

[73] 花王株式會社

Kao Kabushiki Kaisha (Kao Corporation)

14-10, Nihonbashi Kayabacho 1-chome, Chuo-ku, Tokyo

JAPAN

[74] CHINAHONGKONG PATENT LIMITED

3012, 30/F, Office Tower, Convention Plaza, 1 Harbour Road

HONG KONG

HONG KONG

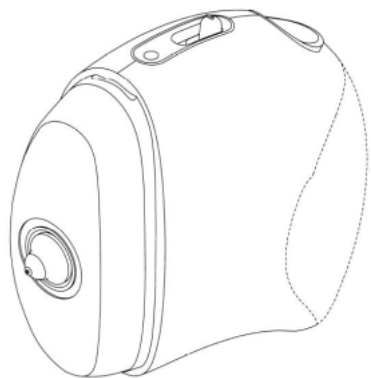

[11] 1914469.0M001

[15] 15-08-2019

[51] Cl. 19-01

Cl. 19-03

Cl. 19-04

Cl. 19-08

[54] 印刷品

Printed matter

[73] BESTIME INTERNATIONAL TRADING LIMITED

FLAT 1, 22/F ASSUN PACIFIC CENTRE,

NO. 41 TSUN YIP STREET, KWUN TONG, KOWLOON, HONG KONG

HONG KONG

[74] IPMS CONSULTANTS LIMITED

UNIT 2004B, 20/F, TOWER 5, CHINA HONG KONG CITY,

33 CANTON ROAD, TSIM SHA TSUI, KOWLOON,

HONG KONG



[11] 1914469.0M002

- [15] 15-08-2019
- [51] Cl. 19-01
Cl. 19-03
Cl. 19-04
Cl. 19-08
- [54] 印刷品
Printed matter
- [73] BESTIME INTERNATIONAL TRADING LIMITED
FLAT 1, 22/F ASSUN PACIFIC CENTRE,
NO. 41 TSUN YIP STREET, KWUN TONG, KOWLOON, HONG KONG
HONG KONG
- [74] IPMS CONSULTANTS LIMITED
UNIT 2004B, 20/F, TOWER 5, CHINA HONG KONG CITY,
33 CANTON ROAD, TSIM SHA TSUI, KOWLOON,
HONG KONG



- [11] 1914473.8
- [15] 16-08-2019
- [51] Cl. 19-02
- [54] 多功能夾子
Multi-function clip
- [73] 李開培
中國內地
廣東省佛山市南海區丹灶鎮
上安南約村南新街四巷 1 號
- [74] 德龍知識產權集團(香港)有限公司
香港
灣仔軒尼詩道 338 號
北海中心 10 樓 E 室

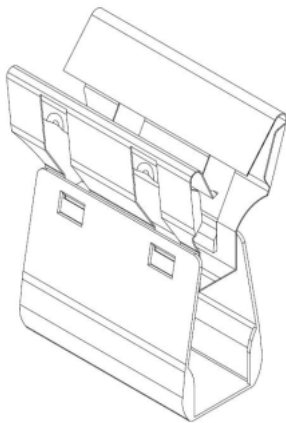

[11] 1914631.5M001

[15] 09-09-2019

[30] 21-03-2019 / EU / 006317418

[51] Cl. 28-03

[54] 剃鬚器
Shaver

[73] Koninklijke Philips N.V.
High Tech Campus 5,
5656 AE Eindhoven
NETHERLANDS

[74] WILKINSON & GRIST
6th Floor, Prince's Building
Chater Road
HONG KONG

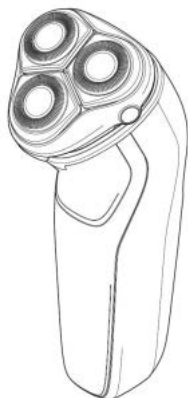

[11] 1914631.5M002

[15] 09-09-2019

[30] 21-03-2019 / EU / 006317418

[51] Cl. 28-03

[54] 剃鬚器
Shaver

[73] Koninklijke Philips N.V.
High Tech Campus 5,
5656 AE Eindhoven
NETHERLANDS

[74] WILKINSON & GRIST
6th Floor, Prince's Building
Chater Road
HONG KONG



[11] 1914633.9

[15] 09-09-2019

[51] Cl. 14-01

[54] 耳机
Earphone

[73] SONY CORPORATION
1-7-1 KONAN, MINATO-KU
TOKYO 108-0075
JAPAN

[74] UNITALEN ATTORNEYS AT LAW LIMITED
RM 1201, 12/F,
GOLDEN ERA PLAZA,
39-55 SAI YEE ST, MONGKOK KLN
HONG KONG

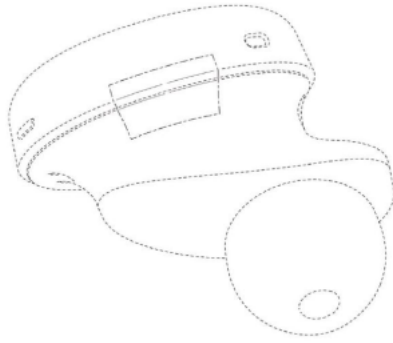

[11] 1914637.8M001

[15] 09-09-2019

[30] 14-03-2019 / DE / 402019100309.6

[51] Cl. 3-01

[54] 行李箱

Suitcase trolley

[73] Libuda, Georg Günter

Zollernstr. 12

78056 VILLINGEN-SCHWENNINGEN

GERMANY

[74] BARRON & YOUNG INTELLECTUAL PROPERTY LIMITED

Suite 617, Lakeside 2

No. 10 Science Park West Avenue, Hong Kong Science Park,
Shatin, N.T.

HONG KONG



[11] 1914637.8M002

[15] 09-09-2019

[30] 14-03-2019 / DE / 402019100309.6

[51] Cl. 3-01

[54] 行李箱

Suitcase trolley

[73] Libuda, Georg Günter

Zollernstr. 12

78056 VILLINGEN-SCHWENNINGEN

GERMANY

[74] BARRON & YOUNG INTELLECTUAL PROPERTY LIMITED

Suite 617, Lakeside 2

No. 10 Science Park West Avenue, Hong Kong Science Park,

Shatin, N.T.

HONG KONG



[11] 1914641.6

[15] 11-09-2019

[51] Cl. 21-01

[54] 模型車

Model vehicle

[73] KABUSHIKI KAISHA TAMIYA (TAMIYA, INC.)

3-7, Ondawara,

Shizuoka-City, 422-8610,

JAPAN

[74] CHAN, TANG & KWOK

Rooms 2503-04, 25/F., Shanghai Industrial Investment Building,

48-62 Hennessy Road, Wanchai,

HONG KONG

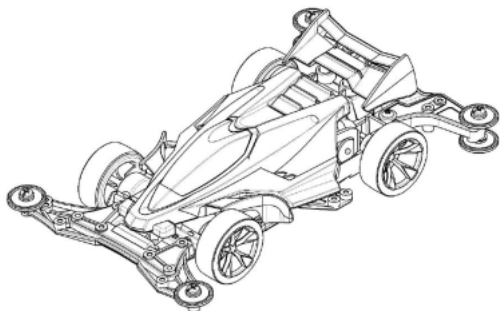

[11] 1914643.0M001

[15] 11-09-2019

[30] 19-03-2019 / SG, CH, TR, UA, EU, KR / DM/200901

[51] Cl. 10-07

[54] 錶框

Watch bezel

[73] Breitling SA

Schlachthausstrasse 2

2540 Grenchen,

SWITZERLAND

[74] SO KEUNG YIP & SIN

Room 1009-1012, 10/F., Nan Fung Tower,

No. 173 Des Voeux Road Central

HONG KONG

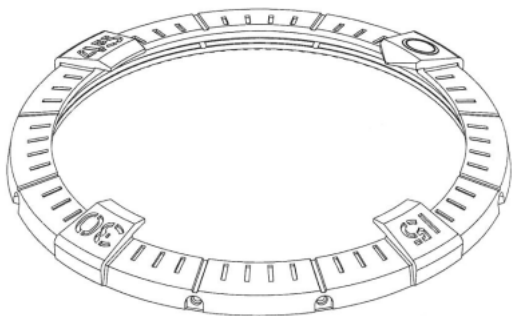

[11] 1914643.0M002

[15] 11-09-2019

[30] 19-03-2019 / SG, CH, TR, UA, EU, KR / DM/200901

[51] Cl. 10-07

[54] 錶框

Watch bezel

[73] Breitling SA
Schlachthausstrasse 2
2540 Grenchen,
SWITZERLAND

[74] SO KEUNG YIP & SIN
Room 1009-1012, 10/F., Nan Fung Tower,
No. 173 Des Voeux Road Central
HONG KONG

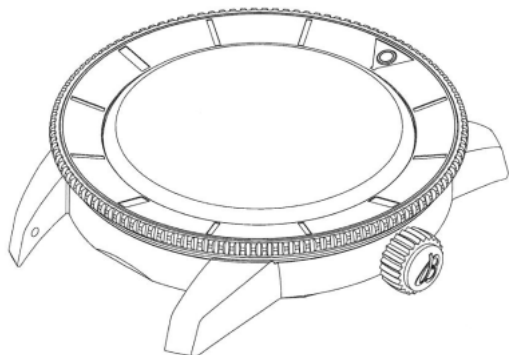

[11] 1914643.0M003

[15] 11-09-2019

[30] 19-03-2019 / SG, CH, TR, UA, EU, KR / DM/200901

[51] Cl. 10-07

[54] 錶殼

Watch case

[73] Breitling SA
Schlachthausstrasse 2
2540 Grenchen,
SWITZERLAND

[74] SO KEUNG YIP & SIN
Room 1009-1012, 10/F., Nan Fung Tower,
No. 173 Des Voeux Road Central
HONG KONG

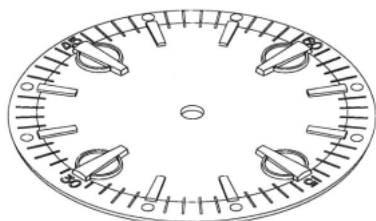

[11] 1914643.0M004

- [15] 11-09-2019
[30] 19-03-2019 / SG, CH, TR, UA, EU, KR / DM/200901
[51] Cl. 10-07
[54] 錶殼
Watch case
[73] Breitling SA
Schlachthausstrasse 2
2540 Grenchen,
SWITZERLAND
[74] SO KEUNG YIP & SIN
Room 1009-1012, 10/F., Nan Fung Tower,
No. 173 Des Voeux Road Central
HONG KONG

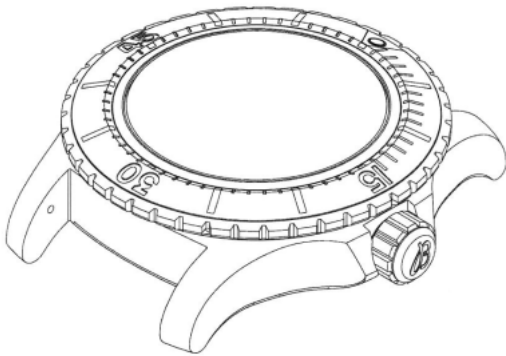

-
- [11] 1914643.0M005
[15] 11-09-2019
[30] 19-03-2019 / SG, CH, TR, UA, EU, KR / DM/200901
[51] Cl. 10-07
[54] 錶盤
Watch dial
[73] Breitling SA
Schlachthausstrasse 2
2540 Grenchen,
SWITZERLAND
[74] SO KEUNG YIP & SIN
Room 1009-1012, 10/F., Nan Fung Tower,
No. 173 Des Voeux Road Central
HONG KONG

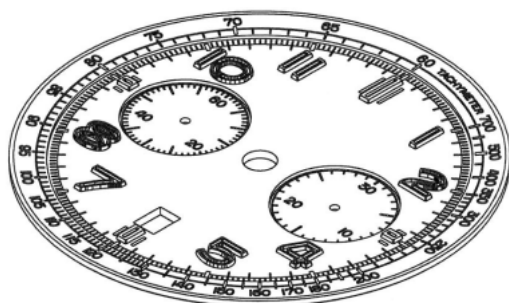

[11] 1914643.0M006

[15] 11-09-2019

[30] 19-03-2019 / SG, CH, TR, UA, EU, KR / DM/200901

[51] Cl. 10-07

[54] 錶盤

Watch dial

[73] Breitling SA

Schlachthausstrasse 2

2540 Grenchen,

SWITZERLAND

[74] SO KEUNG YIP & SIN

Room 1009-1012, 10/F., Nan Fung Tower,

No. 173 Des Voeux Road Central

HONG KONG

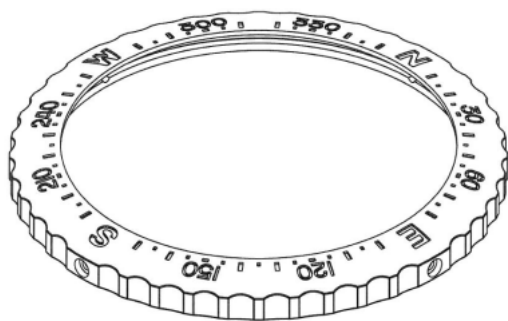

[11] 1914643.0M007

[15] 11-09-2019

[30] 19-03-2019 / SG, CH, TR, UA, EU, KR / DM/200901

[51] Cl. 10-07

[54] 錶盤

Watch dial

[73] Breitling SA

Schlachthausstrasse 2

2540 Grenchen,

SWITZERLAND

[74] SO KEUNG YIP & SIN

Room 1009-1012, 10/F., Nan Fung Tower,

No. 173 Des Voeux Road Central

HONG KONG

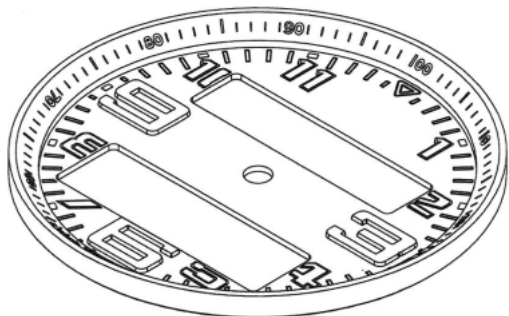

[11] 1914645.5

[15] 12-09-2019

[30] 15-03-2019 / CH / DM/200 837

[51] Cl. 10-07

[54] 錶面

Watch dial

[73] LVMH SWISS MANUFACTURES SA

Rue Louis-Joseph Chevrolet 6A

2300 La Chaux-de-Fonds

SWITZERLAND

[74] WENPING & CO

1701 Tung Wai Commercial Building,

111 Gloucester Road,

HONG KONG



[11] 1914647.9

[15] 12-09-2019

[51] Cl. 8-08

[54] 氣動支架

Pneumatic support

[73] SHENZHEN HOUJIFUXIN SMART HOME CO., LTD

深圳厚積福鑫智能家居有限公司

中國內地

深圳市龍崗區坪地街道

四方埔社區裕民巷 2 號, 518117

[74] 百睿知識產權有限公司

香港

新界沙田香港科學園

科技大道西 10 號浚湖樓 617 室

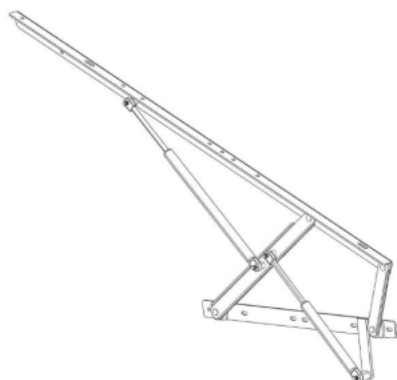

[11] 1914649.3

[15] 12-09-2019

[51] Cl. 7-01

[54] 杯子
Tumbler

[73] 象印有限公司
ZOJIRUSHI CORPORATION
20-5, Tenma 1-chome, Kita-ku
Osaka-shi, Osaka 530-8511
JAPAN

[74] MARKS & CLERK
Level 9, Cyberport 1
100 Cyberport Road, Pok Fu Lam
HONG KONG



[11] 1914651.7M001

[15] 12-09-2019

[51] Cl. 7-02

[54] 鍋底部
Pan bottom

[73] Fissler GmbH
Harald-Fissler-Straße 1
55743 Idar-Oberstein
GERMANY

[74] WILKINSON & GRIST
6th Floor, Prince's Building
Chater Road
HONG KONG

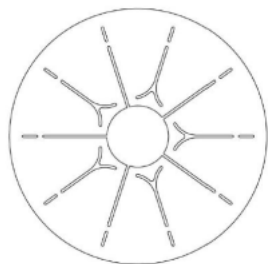

[11] 1914651.7M002

[15] 12-09-2019

[51] Cl. 7-02

[54] 鍋底部

Pan bottom

[73] Fissler GmbH

Harald-Fissler-Straße 1

55743 Idar-Oberstein

GERMANY

[74] WILKINSON & GRIST

6th Floor, Prince's Building

Chater Road

HONG KONG



[11] 1914651.7M003

[15] 12-09-2019

[51] Cl. 7-02

[54] 鍋柄

Pan handle

[73] Fissler GmbH

Harald-Fissler-Straße 1

55743 Idar-Oberstein

GERMANY

[74] WILKINSON & GRIST

6th Floor, Prince's Building

Chater Road

HONG KONG



[11] 1914651.7M004

[15] 12-09-2019

[51] Cl. 7-02

[54] 鍋柄

Pan handle

[73] Fissler GmbH

Harald-Fissler-Straße 1

55743 Idar-Oberstein

GERMANY

[74] WILKINSON & GRIST

6th Floor, Prince's Building

Chater Road

HONG KONG

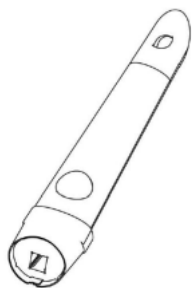

[11] 1914651.7M005

[15] 12-09-2019

[51] Cl. 7-02

[54] 壓力鍋手柄

Pressure cooker handle

[73] Fissler GmbH

Harald-Fissler-Straße 1

55743 Idar-Oberstein

GERMANY

[74] WILKINSON & GRIST

6th Floor, Prince's Building

Chater Road

HONG KONG



[11] 1914651.7M006

[15] 12-09-2019

[51] Cl. 7-02

[54] 壓力鍋閥

Pressure cooker valve

[73] Fissler GmbH
Harald-Fissler-Straße 1
55743 Idar-Oberstein
GERMANY

[74] WILKINSON & GRIST
6th Floor, Prince's Building
Chater Road
HONG KONG



[11] 1914651.7M007

[15] 12-09-2019

[51] Cl. 7-02

[54] 鍋手柄
Pot handle

[73] Fissler GmbH
Harald-Fissler-Straße 1
55743 Idar-Oberstein
GERMANY

[74] WILKINSON & GRIST
6th Floor, Prince's Building
Chater Road
HONG KONG

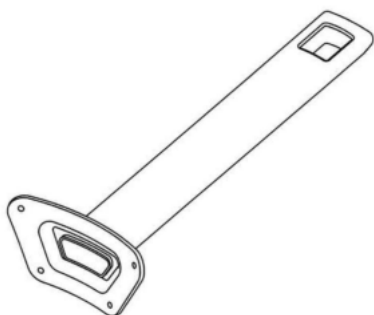

[11] 1914651.7M008

[15] 12-09-2019

[51] Cl. 7-02

[54] 鍋手柄

Pot handle

[73] Fissler GmbH

Harald-Fissler-Straße 1

55743 Idar-Oberstein

GERMANY

[74] WILKINSON & GRIST

6th Floor, Prince's Building

Chater Road

HONG KONG

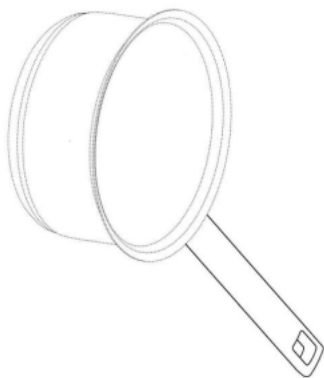

[11] 1914651.7M009

[15] 12-09-2019

[51] Cl. 7-02

[54] 鍋底部

Pan bottom

[73] Fissler GmbH

Harald-Fissler-Straße 1

55743 Idar-Oberstein

GERMANY

[74] WILKINSON & GRIST

6th Floor, Prince's Building

Chater Road

HONG KONG

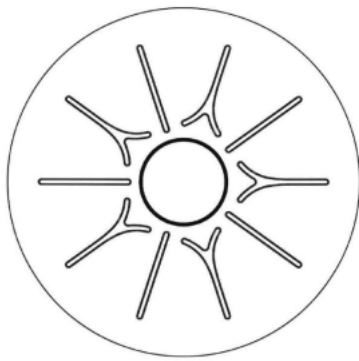

[11] 1914651.7M010

[15] 12-09-2019

[51] Cl. 7-02

[54] 鍋蓋

Pot lid

[73] Fissler GmbH

Harald-Fissler-Straße 1

55743 Idar-Oberstein

GERMANY

[74] WILKINSON & GRIST

6th Floor, Prince's Building

Chater Road

HONG KONG

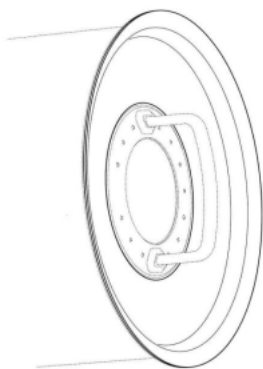

[11] 1914651.7M011

[15] 12-09-2019

[51] Cl. 7-02

[54] 鍋蓋手柄

Pot lid handle

[73] Fissler GmbH

Harald-Fissler-Straße 1

55743 Idar-Oberstein

GERMANY

[74] WILKINSON & GRIST

6th Floor, Prince's Building

Chater Road

HONG KONG

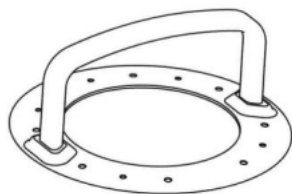

[11] 1914651.7M012

[15] 12-09-2019

[51] Cl. 7-02

[54] 鍋蓋手柄

Pot lid handle

[73] Fissler GmbH

Harald-Fissler-Straße 1

55743 Idar-Oberstein

GERMANY

[74] WILKINSON & GRIST

6th Floor, Prince's Building

Chater Road

HONG KONG

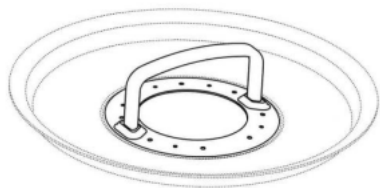

[11] 1914651.7M013

[15] 12-09-2019

[51] Cl. 7-02

[54] 鍋
Pot

[73] Fissler GmbH
Harald-Fissler-Straße 1
55743 Idar-Oberstein
GERMANY

[74] WILKINSON & GRIST
6th Floor, Prince's Building
Chater Road
HONG KONG

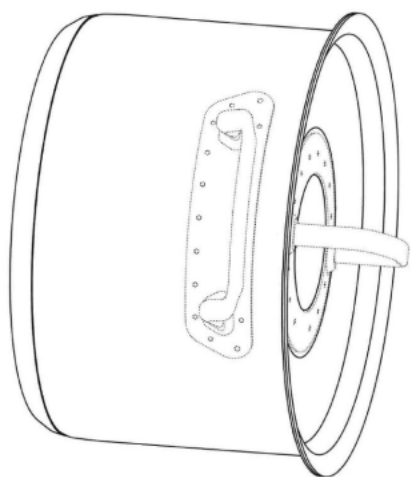

[11] 1914651.7M014

[15] 12-09-2019

[51] Cl. 7-02

[54] 鍋手柄
Pot handle

[73] Fissler GmbH
Harald-Fissler-Straße 1
55743 Idar-Oberstein
GERMANY

[74] WILKINSON & GRIST
6th Floor, Prince's Building
Chater Road
HONG KONG

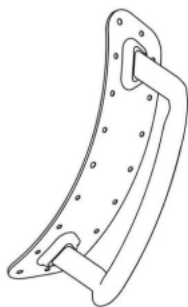

[11] 1914651.7M015

[15] 12-09-2019

[51] Cl. 7-02

[54] 鍋手柄

Pot handle

[73] Fissler GmbH

Harald-Fissler-Straße 1

55743 Idar-Oberstein

GERMANY

[74] WILKINSON & GRIST

6th Floor, Prince's Building

Chater Road

HONG KONG



[11] 1914651.7M016

[15] 12-09-2019

[51] Cl. 7-02

[54] 鍋

Pot

[73] Fissler GmbH

Harald-Fissler-Straße 1

55743 Idar-Oberstein

GERMANY

[74] WILKINSON & GRIST

6th Floor, Prince's Building

Chater Road

HONG KONG



[11] 1914651.7M017

[15] 12-09-2019

[51] Cl. 7-02

[54] 鍋

Pot

[73] Fissler GmbH

Harald-Fissler-Straße 1

55743 Idar-Oberstein

GERMANY

[74] WILKINSON & GRIST

6th Floor, Prince's Building

Chater Road

HONG KONG



[11] 1914651.7M018

[15] 12-09-2019

[51] Cl. 7-02

[54] 鍋

Pot

[73] Fissler GmbH

Harald-Fissler-Straße 1

55743 Idar-Oberstein

GERMANY

[74] WILKINSON & GRIST

6th Floor, Prince's Building

Chater Road

HONG KONG



[11] 1914653.1

[15] 13-09-2019

[30] 15-03-2019 / EU / 006307054

[51] Cl. 12-08

[54] 汽車

Car

[73] FERRARI S.p.A.

VIA EMILIA EST 1163

I-41100 MODENA

ITALY

[74] CHINA PATENT AGENT (HONG KONG) LIMITED

22/F, Great Eagle Centre, 23 Harbour Road,
Wanchai

HONG KONG

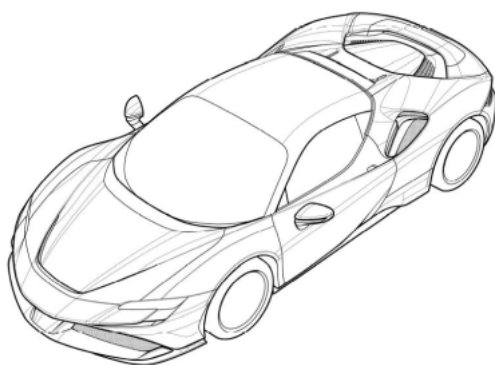

[11] 1914656.8

[15] 13-09-2019

[51] Cl. 3-01

[54] 文件袋

Document bag

[73] CITYBUS LTD

8 CHONG FU ROAD,

CHAI WAN, HONG KONG

HONG KONG

[74] IPMS CONSULTANTS LIMITED

UNIT 2004B, 20/F, TOWER 5, CHINA HONG KONG CITY,
33 CANTON ROAD, TSIM SHA TSUI, KOWLOON,

HONG KONG



[11] 1914657.0

[15] 13-09-2019

[51] Cl. 19-04

[54] 文件夾

Document folder

[73] CITYBUS LTD

8 CHONG FU ROAD,

CHAI WAN,

HONG KONG

HONG KONG

[74] IPMS CONSULTANTS LIMITED

UNIT 2004B, 20/F, TOWER 5, CHINA HONG KONG CITY,

33 CANTON ROAD, TSIM SHA TSUI, KOWLOON,

HONG KONG



[11] 1914658.2M001

[15] 13-09-2019

[51] Cl. 19-01

Cl. 19-03

Cl. 19-04

Cl. 19-08

[54] 印刷品

Printed matter

[73] BESTIME INTERNATIONAL TRADING LIMITED

FLAT 1, 22/F ASSUN PACIFIC CENTRE,

NO. 41 TSUN YIP STREET, KWUN TONG, KOWLOON, HONG KONG

HONG KONG

[74] IPMS CONSULTANTS LIMITED

UNIT 2004B, 20/F, TOWER 5, CHINA HONG KONG CITY,

33 CANTON ROAD, TSIM SHA TSUI, KOWLOON,

HONG KONG

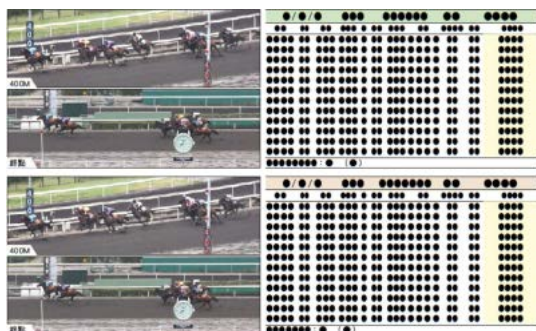

[11] 1914658.2M002

[15] 13-09-2019

[51] Cl. 19-01

Cl. 19-03

Cl. 19-04

Cl. 19-08

[54] 印刷品

Printed matter

[73] BESTIME INTERNATIONAL TRADING LIMITED

FLAT 1, 22/F ASSUN PACIFIC CENTRE,

NO. 41 TSUN YIP STREET, KWUN TONG, KOWLOON, HONG KONG

HONG KONG

[74] IPMS CONSULTANTS LIMITED

UNIT 2004B, 20/F, TOWER 5, CHINA HONG KONG CITY,

33 CANTON ROAD, TSIM SHA TSUI, KOWLOON,

HONG KONG

各場騎師出賽表

[11] 1914658.2M003

[15] 13-09-2019

[51] Cl. 19-01

Cl. 19-03

Cl. 19-04

Cl. 19-08

[54] 印刷品

Printed matter

[73] BESTIME INTERNATIONAL TRADING LIMITED

FLAT 1, 22/F ASSUN PACIFIC CENTRE,

NO. 41 TSUN YIP STREET, KWUN TONG, KOWLOON, HONG KONG

HONG KONG

[74] IPMS CONSULTANTS LIMITED

UNIT 2004B, 20/F, TOWER 5, CHINA HONG KONG CITY,

33 CANTON ROAD, TSIM SHA TSUI, KOWLOON,

HONG KONG

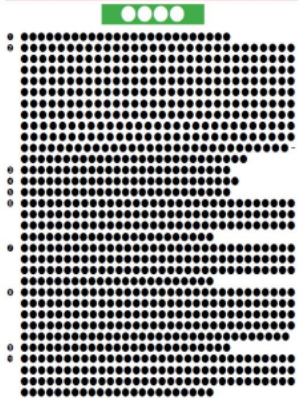

[11] 1914658.2M004

[15] 13-09-2019

- [51] Cl. 19-01
- Cl. 19-03
- Cl. 19-04
- Cl. 19-08

[54] 印刷品
Printed matter

[73] BESTIME INTERNATIONAL TRADING LIMITED
FLAT 1, 22/F ASSUN PACIFIC CENTRE,
NO. 41 TSUN YIP STREET, KWUN TONG, KOWLOON, HONG KONG
HONG KONG

[74] IPMS CONSULTANTS LIMITED
UNIT 2004B, 20/F, TOWER 5, CHINA HONG KONG CITY,
33 CANTON ROAD, TSIM SHA TSUI, KOWLOON,
HONG KONG



[11] 1914658.2M005

[15] 13-09-2019

- [51] Cl. 19-01
- Cl. 19-03
- Cl. 19-04
- Cl. 19-08

[54] 印刷品
Printed matter

[73] BESTIME INTERNATIONAL TRADING LIMITED
FLAT 1, 22/F ASSUN PACIFIC CENTRE,
NO. 41 TSUN YIP STREET, KWUN TONG, KOWLOON, HONG KONG
HONG KONG

[74] IPMS CONSULTANTS LIMITED
UNIT 2004B, 20/F, TOWER 5, CHINA HONG KONG CITY,
33 CANTON ROAD, TSIM SHA TSUI, KOWLOON,
HONG KONG



- [11] 1914658.2M006
- [15] 13-09-2019
- [51] Cl. 19-01
Cl. 19-03
Cl. 19-04
Cl. 19-08
- [54] 印刷品
Printed matter
- [73] BESTIME INTERNATIONAL TRADING LIMITED
FLAT 1, 22/F ASSUN PACIFIC CENTRE,
NO. 41 TSUN YIP STREET, KWUN TONG, KOWLOON, HONG KONG
HONG KONG
- [74] IPMS CONSULTANTS LIMITED
UNIT 2004B, 20/F, TOWER 5, CHINA HONG KONG CITY,
33 CANTON ROAD, TSIM SHA TSUI, KOWLOON,
HONG KONG

[11] 1914658.2M007

[15] 13-09-2019

[51] Cl. 19-01

Cl. 19-03

Cl. 19-04

Cl. 19-08

[54] 印刷品

Printed matter

[73] BESTIME INTERNATIONAL TRADING LIMITED

FLAT 1, 22/F ASSUN PACIFIC CENTRE,

NO. 41 TSUN YIP STREET, KWUN TONG, KOWLOON, HONG KONG

HONG KONG

[74] IPMS CONSULTANTS LIMITED

UNIT 2004B, 20/F, TOWER 5, CHINA HONG KONG CITY,

33 CANTON ROAD, TSIM SHA TSUI, KOWLOON,

HONG KONG



[11] 1914658.2M008

[15] 13-09-2019

[51] Cl. 19-01

Cl. 19-03

Cl. 19-04

Cl. 19-08

[54] 印刷品

Printed matter

[73] BESTIME INTERNATIONAL TRADING LIMITED

FLAT 1, 22/F ASSUN PACIFIC CENTRE,

NO. 41 TSUN YIP STREET, KWUN TONG, KOWLOON, HONG KONG

HONG KONG

[74] IPMS CONSULTANTS LIMITED
 UNIT 2004B, 20/F, TOWER 5, CHINA HONG KONG CITY,
 33 CANTON ROAD, TSIM SHA TSUI, KOWLOON,
 HONG KONG

出賣馬匹分廠表

1914658.2M009	13-09-2019	C1. 19-01	C1. 19-03	C1. 19-04	C1. 19-08	印刷品	Printed matter
BESTIME INTERNATIONAL TRADING LIMITED	FLAT 1, 22/F ASSUN PACIFIC CENTRE,	NO. 41 TSUN YIP STREET, KWUN TONG, KOWLOON, HONG KONG	HONG KONG				
IPMS CONSULTANTS LIMITED	UNIT 2004B, 20/F, TOWER 5, CHINA HONG KONG CITY,	33 CANTON ROAD, TSIM SHA TSUI, KOWLOON,	HONG KONG				

[11] 1914658.2M009

[15] 13-09-2019

[51] C1. 19-01
 C1. 19-03
 C1. 19-04
 C1. 19-08

[54] 印刷品
 Printed matter

[73] BESTIME INTERNATIONAL TRADING LIMITED
 FLAT 1, 22/F ASSUN PACIFIC CENTRE,
 NO. 41 TSUN YIP STREET, KWUN TONG, KOWLOON, HONG KONG
 HONG KONG

[74] IPMS CONSULTANTS LIMITED
 UNIT 2004B, 20/F, TOWER 5, CHINA HONG KONG CITY,
 33 CANTON ROAD, TSIM SHA TSUI, KOWLOON,
 HONG KONG

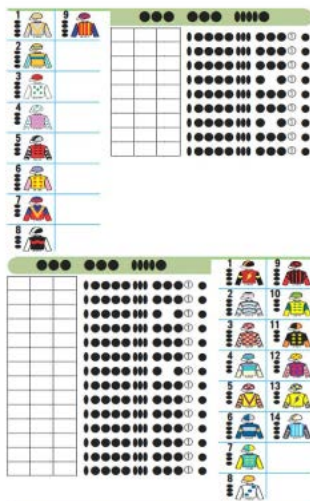

[11] 1914659.4M001

[15] 16-09-2019

[30] 15-03-2019 / MA, RS, SG, CH, TR, UA, EU, KR / DM/200867

[51] Cl. 11-01

[54] 珠寶元素

Elements of jewellery

[73] CHOPARD INTERNATIONAL SA

Route de Promenthoux

1197 Prangins

SWITZERLAND

[74] WILKINSON & GRIST

6th Floor, Prince's Building

Chater Road

HONG KONG

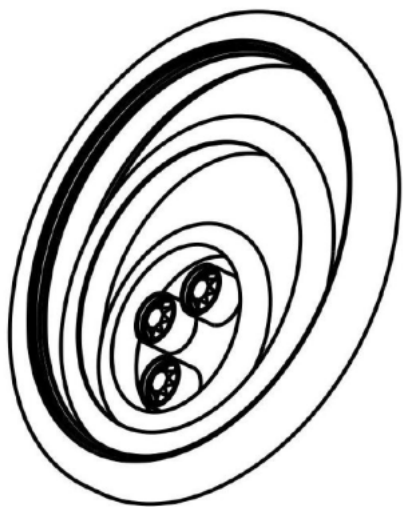

- [11] 1914659.4M002
[15] 16-09-2019
[30] 15-03-2019 / MA, RS, SG, CH, TR, UA, EU, KR / DM/200867
[51] Cl. 11-01
[54] 珠寶元素
Elements of jewellery
[73] CHOPARD INTERNATIONAL SA
Route de Promenthoux
1197 Prangins
SWITZERLAND
[74] WILKINSON & GRIST
6th Floor, Prince's Building
Chater Road
HONG KONG

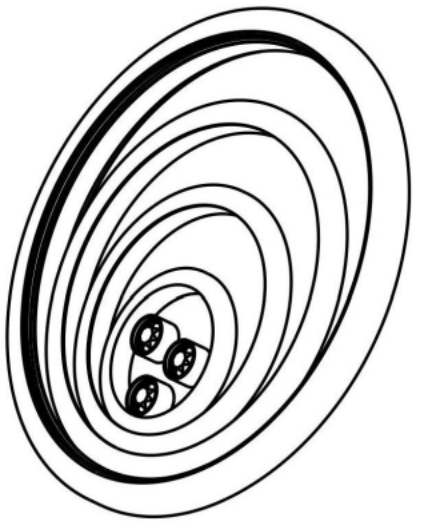

-
- [11] 1914659.4M003
[15] 16-09-2019
[30] 15-03-2019 / MA, RS, SG, CH, TR, UA, EU, KR / DM/200867
[51] Cl. 11-01
[54] 珠寶元素
Elements of jewellery
[73] CHOPARD INTERNATIONAL SA
Route de Promenthoux
1197 Prangins
SWITZERLAND
[74] WILKINSON & GRIST
6th Floor, Prince's Building
Chater Road
HONG KONG



[11] 1914659.4M004

[15] 16-09-2019

[30] 15-03-2019 / MA, RS, SG, CH, TR, UA, EU, KR / DM/200867

[51] Cl. 11-01

[54] 手鐲

Bracelet

[73] CHOPARD INTERNATIONAL SA

Route de Promenthoux

1197 Prangins

SWITZERLAND

[74] WILKINSON & GRIST

6th Floor, Prince's Building

Chater Road

HONG KONG

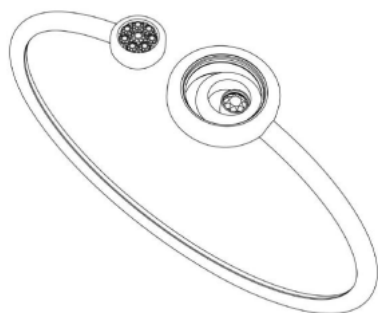

[11] 1914659.4M005

[15] 16-09-2019

[30] 15-03-2019 / MA, RS, SG, CH, TR, UA, EU, KR / DM/200867

[51] Cl. 11-01

[54] 戒指
Ring

[73] CHOPARD INTERNATIONAL SA
Route de Promenthoux
1197 Prangins
SWITZERLAND

[74] WILKINSON & GRIST
6th Floor, Prince's Building
Chater Road
HONG KONG

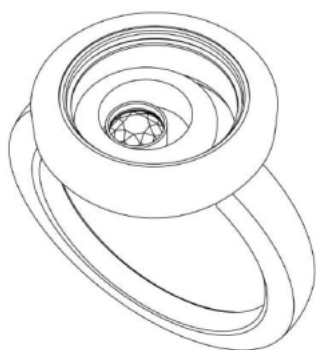

[11] 1914661.8M001

[15] 16-09-2019

[51] Cl. 14-04

[54] 用於電子設備的圖形用戶界面
Graphical user interface for electronic device

[73] Redsip Limited
Unit 54, Level 5, Core F, Cyberport 3
100 Cyberport Road
HONG KONG

[74] MARKS & CLERK
Level 9, Cyberport 1
100 Cyberport Road, Pok Fu Lam
HONG KONG

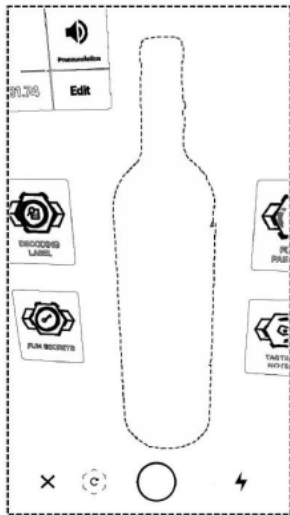

[11] 1914661.8M002

[15] 16-09-2019

[51] Cl. 14-04

[54] 用於電子設備的圖形用戶界面
Graphical user interface for electronic device

[73] Redsip Limited
Unit 54, Level 5, Core F, Cyberport 3
100 Cyberport Road
HONG KONG

[74] MARKS & CLERK
Level 9, Cyberport 1
100 Cyberport Road, Pok Fu Lam
HONG KONG

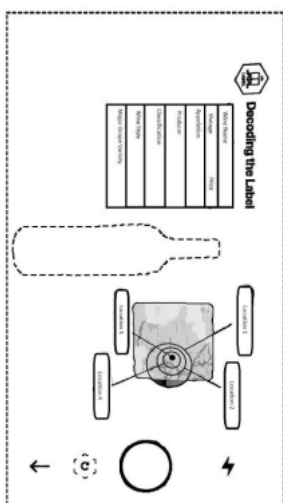

[11] 1914661.8M003

[15] 16-09-2019

[51] Cl. 14-04

[54] 用於電子設備的圖形用戶界面

Graphical user interface for electronic device

[73] Redsip Limited

Unit 54, Level 5, Core F, Cyberport 3

100 Cyberport Road

HONG KONG

[74] MARKS & CLERK

Level 9, Cyberport 1

100 Cyberport Road, Pok Fu Lam

HONG KONG

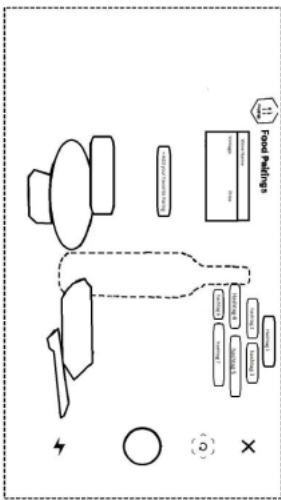

[11] 1914661.8M004

[15] 16-09-2019

[51] Cl. 14-04

[54] 用於電子設備的圖形用戶界面

Graphical user interface for electronic device

[73] Redsip Limited

Unit 54, Level 5, Core F, Cyberport 3

100 Cyberport Road

HONG KONG

[74] MARKS & CLERK

Level 9, Cyberport 1

100 Cyberport Road, Pok Fu Lam

HONG KONG

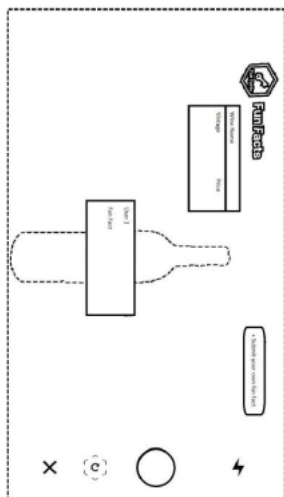

[11] 1914661.8M005

[15] 16-09-2019

[51] Cl. 14-04

[54] 用於電子設備的圖形用戶界面

Graphical user interface for electronic device

[73] Redsip Limited

Unit 54, Level 5, Core F, Cyberport 3

100 Cyberport Road

HONG KONG

[74] MARKS & CLERK

Level 9, Cyberport 1

100 Cyberport Road, Pok Fu Lam

HONG KONG



[11] 1914661.8M006

[15] 16-09-2019

[51] Cl. 14-04

[54] 用於電子設備的圖形用戶界面

Graphical user interface for electronic device

[73] Redsip Limited

Unit 54, Level 5, Core F, Cyberport 3

100 Cyberport Road

HONG KONG

[74] MARKS & CLERK

Level 9, Cyberport 1

100 Cyberport Road, Pok Fu Lam

HONG KONG

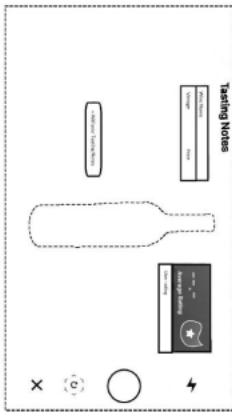

[11] 1914661.8M007

[15] 16-09-2019

[51] Cl. 14-04

[54] 用於電子設備的圖形用戶界面

Graphical user interface for electronic device

[73] Redsip Limited

Unit 54, Level 5, Core F, Cyberport 3

100 Cyberport Road

HONG KONG

[74] MARKS & CLERK

Level 9, Cyberport 1

100 Cyberport Road, Pok Fu Lam

HONG KONG

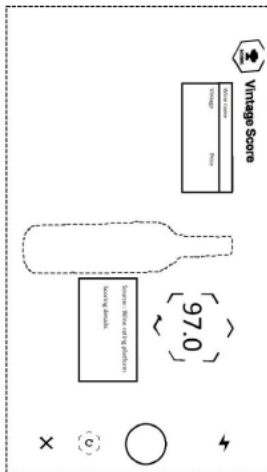

[11] 1914663.2

[15] 17-09-2019

[30] 25-03-2019 / DE / 402019100370.3

[51] Cl. 21-01

[54] 比例模型玩具車

Scale model toy vehicle

[73] Bayerische Motoren Werke Aktiengesellschaft

Petuelring 130, 80809 Muenchen,
GERMANY

[74] HASTINGS & CO

5/F Gloucester Tower, The Landmark,
11 Pedder Street, Central,
HONG KONG



[11] 1914665.7M001

[15] 17-09-2019

[30] 29-03-2019 / AU / 201911819

[51] Cl. 14-03

[54] 無線接收器

Wireless receiver

[73] Freedman Electronics Pty Limited
107 Carnarvon Street
Silverwater, New South Wales 2128
AUSTRALIA

[74] WENPING & CO
1701 Tung Wai Commercial Building,
111 Gloucester Road,
HONG KONG

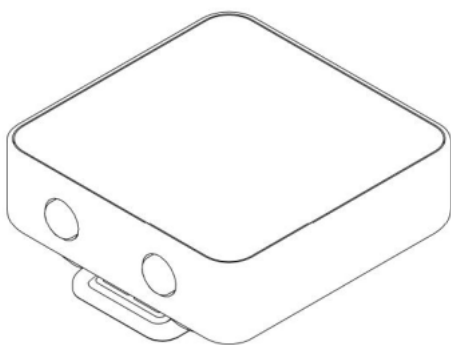

[11] 1914665.7M002

[15] 17-09-2019

[30] 29-03-2019 / AU / 201911820

[51] Cl. 14-03

[54] 無線發射器

Wireless transmitter

[73] Freedman Electronics Pty Limited
107 Carnarvon Street
Silverwater, New South Wales 2128
AUSTRALIA

[74] WENPING & CO
1701 Tung Wai Commercial Building,
111 Gloucester Road,
HONG KONG

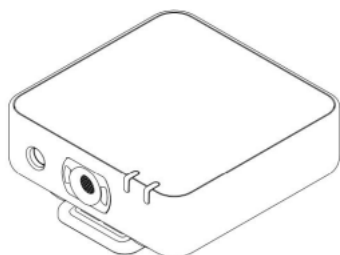

[11] 1914667.1

[15] 17-09-2019

[30] 18-03-2019 / CN / 201930110364.9

[51] Cl. 13-02

[54] 掃地機充電座

Sweeper charger

[73] 北京小米移動軟件有限公司

Beijing Xiaomi Mobile Software Co., Ltd.

中國內地

北京市海澱區清河中街 68 號

華潤五彩城購物中心二期 9 層 01 房間

[74] 隆天專利商標代理有限公司

香港

九龍青山道 485 號

九龍廣場 10 樓 11 室



[11] 1914669.5

[15] 17-09-2019

[30] 18-03-2019 / CN / 201930110366.8

[51] Cl. 15-05

[54] 掃地機

Sweeper

[73] 北京小米移動軟件有限公司

Beijing Xiaomi Mobile Software Co., Ltd.

中國內地

北京市海澱區清河中街 68 號

華潤五彩城購物中心二期 9 層 01 房間

[74] 隆天專利商標代理有限公司

香港

九龍青山道 485 號
九龍廣場 10 樓 11 室



[11] 1914671.9

[15] 17-09-2019

[30] 26-03-2019 / JP / 2019-006417

[51] Cl. 28-03

[54] 鍛煉用器具

Training apparatus

[73] 株式會社 MTG

MTG Co., Ltd.

32, HONJIN-DORI 2-CHOME, NAKAMURA-KU, NAGOYA-SHI, AICHI-KEN
453-0041

JAPAN

[74] CHINAHONGKONG IP LIMITED

3011, 30/F, Office Tower, Convention Plaza, 1 Harbour Road
HONG KONG

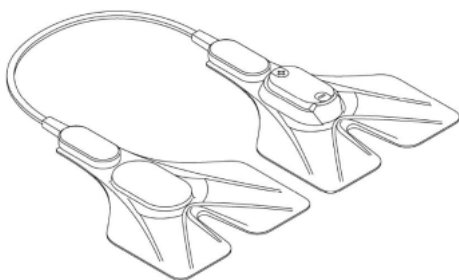

[11] 1914673.3

[15] 18-09-2019

[30] 09-07-2019 / KR / 30-2019-0032878

[51] Cl. 9-03

[54] 飲料包裝用容器

Packaging container for beverage

[73] Binggrae Co., Ltd.

45, Dasansunhwan-ro,

Namyangju-si, Gyeonggi-do,

REPUBLIC OF KOREA

[74] NTD PATENT & TRADE MARK AGENCY LIMITED

Units 1805-6, 18/F., Greenfield Tower, Concordia Plaza,

No. 1 Science Museum Road, Tsimshatsui East, Kowloon,

HONG KONG



[11] 1914677.2

[15] 18-09-2019

[51] Cl. 25-02

[54] 扶手

Handrail

[73] Kansatsu no Ki Ltd.

5F., No.13, Ln. 28, Renxing St., Sanchong Dist., New Taipei

City 241

TAIWAN

Kansatsu no Ki Ltd

4F AOI Bldg, 5-18-12 Mita, Minato-Ku, Tokyo, 108-0073

JAPAN

WU, Yi-Fang

5F., No.13, Ln. 28, Renxing St., Sanchong Dist., New Taipei

City 241

TAIWAN

[74] LECTO IP LIMITED

Suite 2207-9, Tower Two, Lippo Centre

89 Queensway, Admiralty
HONG KONG

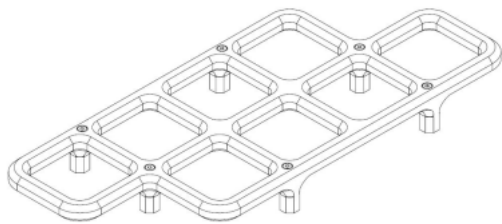

[11] 1914683.4

[15] 19-09-2019

[51] Cl. 30-02

[54] 冷暖寵物屋

Cooler and warmer pet house

[73] 耀發電子有限公司

BRILLIANT RICH ELECTRONICS LIMITED

Flat I, 2/F Universal Industrial Centre

19-21 Shan Mei Street, Fo Tan, Sha Tin

HONG KONG

[74] WENPING & CO

1701 Tung Wai Commercial Building,

111 Gloucester Road,

HONG KONG



[11] 1914685.9M001

[15] 19-09-2019

[30] 19-03-2019 / US / 29/684,233

[51] Cl. 24-04

[54] 吸收物品

Absorbent article

- [73] JOHNSON & JOHNSON CONSUMER INC.
199 Grandview Road, Skillman, NJ 08558
UNITED STATES OF AMERICA
- [74] SHANGHAI INTELLECTUAL PROPERTY OFFICE
Unit F, 20th Floor, Neich Tower,
128 Gloucester Road,
HONG KONG

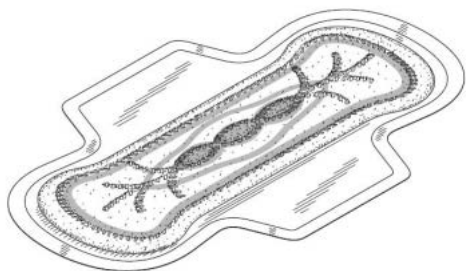

-
- [11] 1914685.9M002
- [15] 19-09-2019
- [30] 19-03-2019 / US / 29/684,233
- [51] Cl. 24-04
- [54] 吸收物品
Absorbent article
- [73] JOHNSON & JOHNSON CONSUMER INC.
199 Grandview Road, Skillman, NJ 08558
UNITED STATES OF AMERICA
- [74] SHANGHAI INTELLECTUAL PROPERTY OFFICE
Unit F, 20th Floor, Neich Tower,
128 Gloucester Road,
HONG KONG

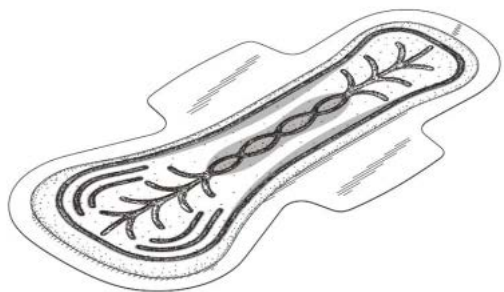

-
- [11] 1914685.9M003

[15] 19-09-2019

[30] 19-03-2019 / US / 29/684,238

[51] Cl. 24-04

[54] 吸收物品

Absorbent article

[73] JOHNSON & JOHNSON CONSUMER INC.

199 Grandview Road, Skillman, NJ 08558

UNITED STATES OF AMERICA

[74] SHANGHAI INTELLECTUAL PROPERTY OFFICE

Unit F, 20th Floor, Neich Tower,

128 Gloucester Road,

HONG KONG

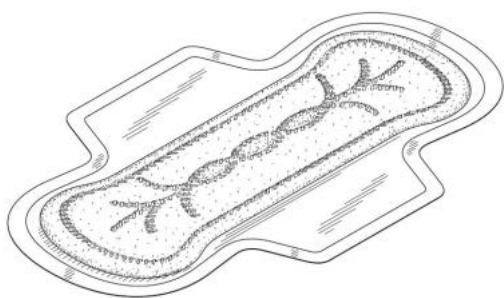

[11] 1914685.9M004

[15] 19-09-2019

[30] 19-03-2019 / US / 29/684,238

[51] Cl. 24-04

[54] 吸收物品

Absorbent article

[73] JOHNSON & JOHNSON CONSUMER INC.

199 Grandview Road, Skillman, NJ 08558

UNITED STATES OF AMERICA

[74] SHANGHAI INTELLECTUAL PROPERTY OFFICE

Unit F, 20th Floor, Neich Tower,

128 Gloucester Road,

HONG KONG

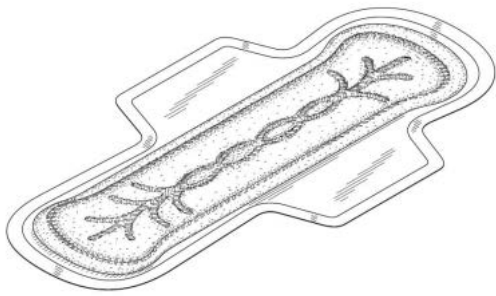

[11] 1914685.9M005

[15] 19-09-2019

[30] 19-03-2019 / US / 29/684,238

[51] Cl. 24-04

[54] 吸收物品

Absorbent article

[73] JOHNSON & JOHNSON CONSUMER INC.

199 Grandview Road, Skillman, NJ 08558

UNITED STATES OF AMERICA

[74] SHANGHAI INTELLECTUAL PROPERTY OFFICE

Unit F, 20th Floor, Neich Tower,

128 Gloucester Road,

HONG KONG

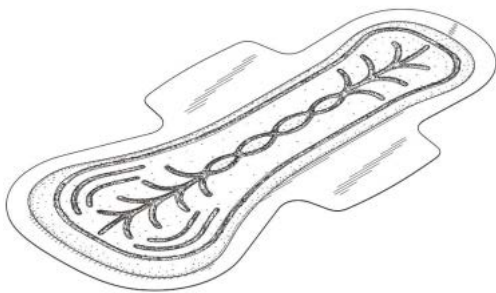

[11] 1914687.3

[15] 19-09-2019

[30] 19-03-2019 / CH, GB, EU / DM/201036

[51] Cl. 10-07

[54] 錶面

Watch-dial

[73] JACOB & CO SA
Rue Dr-Alfred-Vincent 16,
1201 Geneva
SWITZERLAND

[74] UNION PATENT SERVICE CENTRE
Units E-F, 20th Floor, Neich Tower,
128 Gloucester Road,
HONG KONG

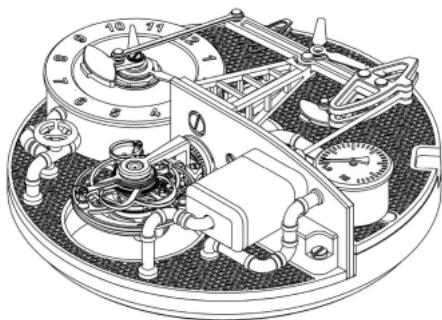

[11] 1914689.7

[15] 19-09-2019

[30] 19-03-2019 / CH, GB, EU / DM/201036

[51] Cl. 10-02

[54] 錶

Watch

[73] JACOB & CO SA
Rue Dr-Alfred-Vincent 16,
1201 Geneva
SWITZERLAND

[74] UNION PATENT SERVICE CENTRE
Units E-F, 20th Floor, Neich Tower,
128 Gloucester Road,
HONG KONG

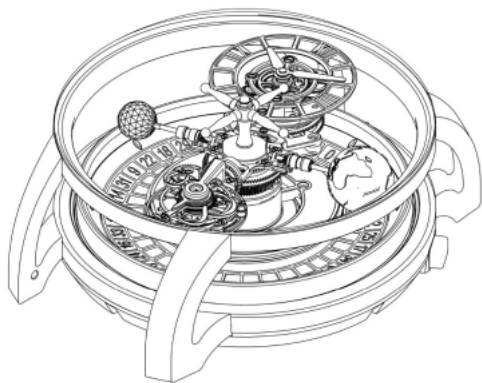

[11] 1914691.1

[15] 19-09-2019

[30] 12-04-2019 / CN / 201930166329.9

[51] Cl. 9-03

[54] 包裝箱

Package box

[73] 索尼公司

SONY CORPORATION

1-7-1 KONAN, MINATO-KU

TOKYO 108-0075, JAPAN

JAPAN

[74] UNITALEN ATTORNEYS AT LAW LIMITED

RM 1201, 12/F,

GOLDEN ERA PLAZA,

39-55 SAI YEE ST, MONGKOK KLN

HONG KONG



[11] 1914695.0

[15] 19-09-2019

[51] Cl. 14-01

[54] 耳機

Earphone

[73] 歐迪高科技有限公司

Audikom Technik Limited

BLK 1, 16/F, GRAND CENTRAL PLAZA,

138 SHATIN RURAL COMMITTEE RD,

SHATIN, NT HONG KONG

[74] GLOBAL INTELLECTUAL PROPERTY COMPANY LIMITED

Unit 2205, 22/F Sino Plaza,

255-257 Gloucester Road, Causeway Bay,

HONG KONG

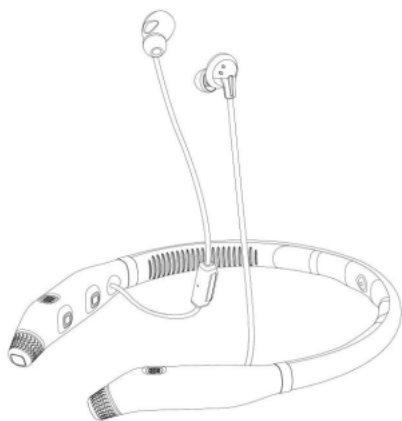

[11] 1914697.4

[15] 20-09-2019

[51] Cl. 16-06

[54] 無線智能眼鏡

Wireless smart glasses

[73] Buttons (Shanghai) Technology Limited

上海未加電子科技有限公司

中國內地

中國(上海)自由貿易試驗區

張楊路 707 號二層西區

[74] 德龍知識產權集團(香港)有限公司

香港

灣仔軒尼詩道 338 號

北海中心 10 樓 E 室



[11] 1914698.6

[15] 20-09-2019

[51] Cl. 13-03

[54] 多頭充電線
Multi charging cable

[73] Xoopar Limited
Room 17-18, 10/F. Landmark North,
39 Lung Sum Ave., Sheung Shui, N.T.
HONG KONG

[74] CHINAHONGKONG PATENT LIMITED
3012, 30/F, Office Tower, Convention Plaza, 1 Harbour Road

HONG KONG
HONG KONG

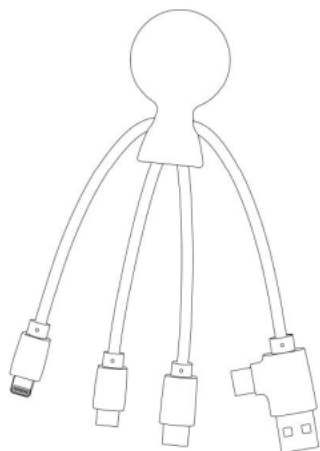

[11] 1914699.8

[15] 20-09-2019

[51] Cl. 23-04

[54] 香薰手表
Scent watch

[73] John Martin William HEDELIN
Beleshögsvägen 45,
Limhamn, 216 18
SWEDEN

[74] CHINAHONGKONG PATENT LIMITED
3012, 30/F, Office Tower, Convention Plaza, 1 Harbour Road

HONG KONG

HONG KONG





香港特別行政區政府知識產權署外觀設計註冊處

The Government of the Hong Kong Special Administrative Region

Designs Registry, Intellectual Property Department

根據註冊外觀設計條例第76條，更正已提交文件中的錯誤

Correction of errors in filed documents under section 76 of the Registered Designs Ordinance

任何人士現可對下列更正錯誤的請求提出反對

Requests for correction of errors now open to opposition

如任何人士意欲反對下列請求，則須在本官方公報刊登是項更正請求的日期起計的兩個月內，根據註冊外觀設計規則第62(4)條，採用指明外觀設計表格第D9號提交反對通知。如在限期內沒有收到任何反對通知，處長將依本公報刊登的更正請求的內容，准許是項更正請求。

If any person wishes to oppose the following requests, he shall file a notice of opposition in specified Designs Form D9 within two months from the date of advertisement in this official journal under section 62(4) of the Registered Designs Rules. If no notice of opposition is received, the requests for correction will be allowed by the Registrar in the present advertised form.

請求更正外觀設計表格第D1號第03部分中申請人的姓名或名稱

Requests made for correction of applicant's name in Part 03 of the Designs Form D1 filed

[21] 1914713.9M001-M002

[71] 北京小米移動軟體有限公司 Beijing Xiaomi Mobile Software Co., Ltd.