

香港知識產權公報

Hong Kong Intellectual Property Journal

2019 年 9 月 13 日
13 September 2019



目錄

Contents

根據註冊外觀設計條例第 25 條註冊的外觀設計

Designs Registered under section 25 of the Registered Designs Ordinance

按註冊編號排列

Arranged by Registration Number

根據註冊外觀設計條例(第 522 章)公布的其他公告

Other Notices Published under the Registered Designs Ordinance (Cap. 522)

根據註冊外觀設計條例第 28 條, 註冊外觀設計因未繳續期費而停止有效

Registered designs ceased through non-payment of renewal fees under section 28 of the Registered Designs Ordinance

根據註冊外觀設計規則第 31 條刪除的註冊外觀設計

Registered designs removed under section 31 of the Registered Designs Rules

根據註冊外觀設計條例第 67 及 76 條, 更正註冊紀錄冊內及已提交文件中的錯誤

Correction of Errors in Register and in Filed Documents under sections 67 and 76 of the Registered Designs Ordinance

根據註冊外觀設計條例第 76 條, 更正已提交文件中的錯誤

Correction of errors in filed documents under section 76 of the Registered Designs Ordinance

以下事項沒有記錄

No Records for the Following Matters

根據註冊外觀設計條例第 30 條放棄的外觀設計的註冊

Surrender of Registration of Design under section 30 of the Registered Designs Ordinance

根據註冊外觀設計規則第 37 條，向處長作出轉介
Reference to Registrar under section 37 of the Registered Designs Rules

根據註冊外觀設計條例第 45 條，撤銷註冊
Revocation of Registration under section 45 of the Registered Designs Ordinance

根據註冊外觀設計規則第 46 條，向法院作出轉介
Reference to Court under section 46 of the Registered Designs Rules

根據註冊外觀設計規則第 63 條對不符合規定之處作出糾正
Rectification of Irregularities under section 63 of the Registered Designs Rules

根據註冊外觀設計條例第 66 條，糾正註冊紀錄冊
Rectification of Register under section 66 of the Registered Designs Ordinance

根據註冊外觀設計條例第 67 條，更正註冊紀錄冊內的錯誤
Correction of Errors in Register under section 67 of the Registered Designs Ordinance

勘誤
Corrigendum

註冊外觀設計公告註釋

Notes on advertisements of registration of designs

方括號表示下列資料：

Square brackets indicate the following data：

- [11] 註冊編號 Registration number / 聯合王國註冊編號 United Kingdom registration number

- [15] 註冊日期 Registration date / 當作註冊日期 Deemed registration date / 聯合王國註冊日期 United Kingdom registration date

- [17] 註冊有效期屆滿日期 Expiry date of the period of registration

- [22] 提交日期 Filing date / 當作提交日期 Deemed filing date / 聯合王國提交日期 United Kingdom filing date

- [30] 聲稱享有的優先權 (提交日期 / 巴黎公約國或世界貿易組織成員 / 申請編號) Priority claimed (filing date / Paris Convention country or WTO member / application number)

- [51] 國際外觀設計分類號 (洛迦諾分類號) International Classification of designs (Locarno Classification)

- [54] 物品 Article

- [55] 外觀設計的表述 Representation of the design

- [62] 分開前的申請編號及提交日期 Application number before division and filing date

- [66] 過往註冊的聯繫外觀設計註冊編號 / 日期 Registration No. / Date of Previous Registration for Association

- [72] 設計人 Designer

[73] 擁有人姓名和地址 Name and address of the owner

[74] 代理人 Agent / 送達地址 Address for service



香港特別行政區政府知識產權署外觀設計註冊處

The Government of the Hong Kong Special Administrative Region

Designs Registry, Intellectual Property Department

根據註冊外觀設計條例第 25 條註冊的外觀設計

Designs registered under section 25 of the Registered Designs Ordinance

按註冊編號排列

Arranged by Registration Number

[11] 1802291.7M001

[15] 23-11-2018

[51] Cl. 28-03

[54] 眉間貼膜

Interbrow mask

[73] 富合友信（北京）商貿有限公司

中國內地北京市通州區 運河核

心區 IV-07 地塊 綠地大廈 1

號樓 22 層 22508

[74] 中港知識產權有限公司

香港港灣道 1 號 會

展廣場辦公大樓 30

樓 3011 室

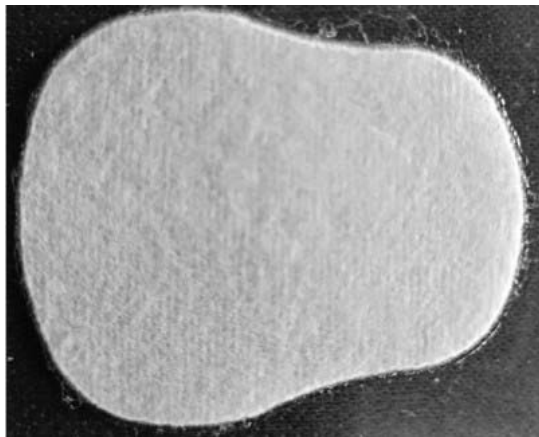

[11] 1802291.7M002

[15] 23-11-2018

[51] Cl. 28-03

[54] 眉間貼膜

Interbrow mask

- [73] 富合友信（北京）商貿有限公司
中國內地北京市通州區 運河核心區 IV-07 地塊 綠地大廈 1 號樓 22 層 22508
- [74] 中港知識產權有限公司
香港港灣道 1 號 會展廣場辦公大樓 30 樓 3011 室

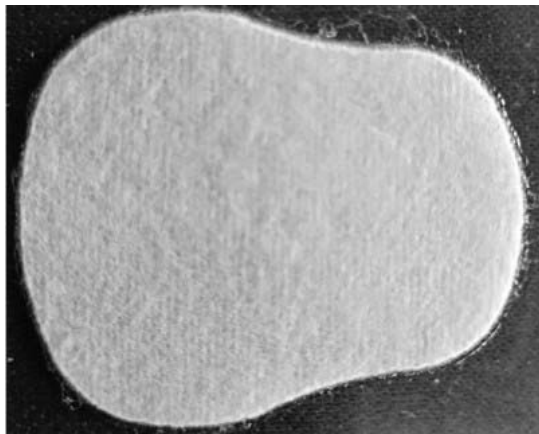

-
- [11] 1802291.7M003
- [15] 23-11-2018
- [51] Cl. 28-03
- [54] 眉間貼膜
Interbrow mask
- [73] 富合友信（北京）商貿有限公司
中國內地北京市通州區 運河核心區 IV-07 地塊 綠地大廈 1 號樓 22 層 22508
- [74] 中港知識產權有限公司
香港港灣道 1 號 會展廣場辦公大樓 30 樓 3011 室

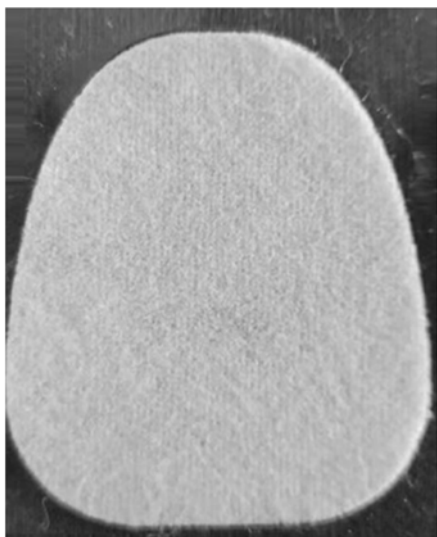

-
- [11] 1802368.1

[15] 30-11-2018

[51] Cl. 7-06

[54] 杯墊

Coaster

[73] TALK Creative Co., Ltd.

Higashi Gotanda 5-4-1-306

Shinagawa-ku, Tokyo

JAPAN

[74] Pui Ying Lui

12C, 1 Dragon Terrace,

Causeway Bay, Hong Kong

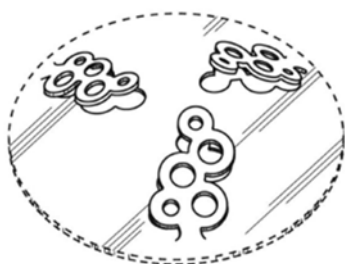

[11] 1802383.2M001

[15] 03-12-2018

[30] 03-06-2018 / US / 29/649,906

[51] Cl. 14-04

[54] 用於電子裝置的圖形用戶界面

Graphical user interface for electronic device

[73] 蘋果公司

APPLE INC.

ONE APPLE PARK WAY,

CUPERTINO, CALIFORNIA 95014,

UNITED STATES

[74] CLT Patent & Trademark (H.K.) Ltd.

Unit 09, 34/F., Office Tower, Convention Plaza,

No. 1 Harbour Road, Wanchai,

Hong Kong.

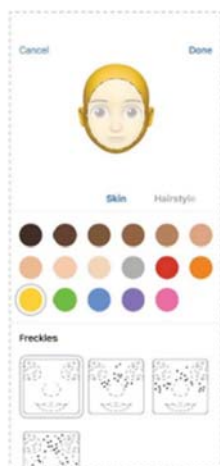

[11] 1802383.2M002

[15] 03-12-2018

[30] 03-06-2018 / US / 29/649,906

[51] Cl. 14-04

[54] 用於電子裝置的圖形用戶界面

Graphical user interface for electronic device

[73] 蘋果公司

APPLE INC.

ONE APPLE PARK WAY, CUPERTINO, CALIFORNIA 95014,
UNITED STATES

[74] CLT Patent & Trademark (H.K.) Ltd.

Unit 09, 34/F., Office Tower, Convention Plaza, No. 1 Harbour
Road, Wanchai, Hong Kong.

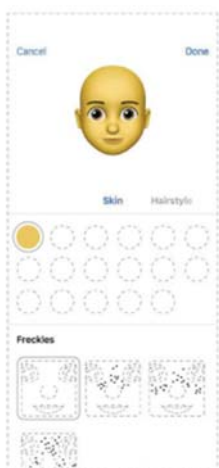

[11] 1802383.2M003

[15] 03-12-2018

[30] 03-06-2018 / US / 29/649,906

[51] Cl. 14-04

[54] 用於電子裝置的圖形用戶界面

Graphical user interface for electronic device

[73] 蘋果公司

APPLE INC.

ONE APPLE PARK WAY, CUPERTINO, CALIFORNIA 95014,
UNITED STATES

[74] CLT Patent & Trademark (H.K.) Ltd.

Unit 09, 34/F., Office Tower, Convention Plaza, No. 1 Harbour
Road, Wanchai, Hong Kong.

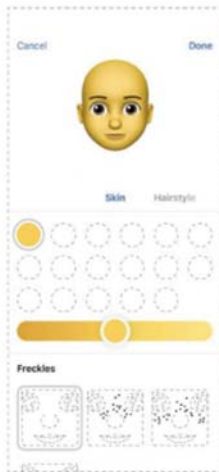

[11] 1802383.2M004

[15] 03-12-2018

[30] 03-06-2018 / US / 29/649,906

[51] Cl. 14-04

[54] 用於電子裝置的圖形用戶界面

Graphical user interface for electronic device

[73] 蘋果公司

APPLE INC.

ONE APPLE PARK WAY, CUPERTINO, CALIFORNIA 95014,
UNITED STATES

[74] CLT Patent & Trademark (H.K.) Ltd.

Unit 09, 34/F., Office Tower, Convention Plaza, No. 1 Harbour
Road, Wanchai, Hong Kong.

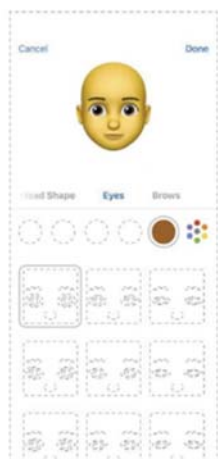

[11] 1802383.2M005

[15] 03-12-2018

[30] 03-06-2018 / US / 29/649,906

[51] Cl. 14-04

[54] 用於電子裝置的圖形用戶界面

Graphical user interface for electronic device

[73] 蘋果公司

APPLE INC.

ONE APPLE PARK WAY, CUPERTINO, CALIFORNIA 95014,
UNITED STATES

[74] CLT Patent & Trademark (H.K.) Ltd.

Unit 09, 34/F., Office Tower, Convention Plaza, No. 1 Harbour
Road, Wanchai, Hong Kong.

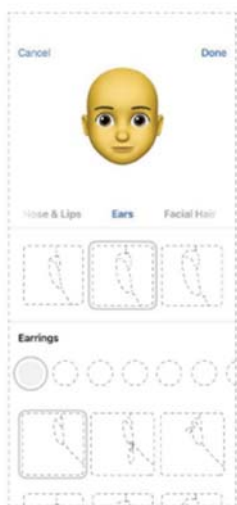

[11] 1802383.2M006

[15] 03-12-2018

[30] 03-06-2018 / US / 29/649,906

[51] Cl. 14-04

[54] 用於電子裝置的圖形用戶界面

Graphical user interface for electronic device

[73] 蘋果公司

APPLE INC.

ONE APPLE PARK WAY, CUPERTINO, CALIFORNIA 95014,
UNITED STATES

[74] CLT Patent & Trademark (H.K.) Ltd.

Unit 09, 34/F., Office Tower, Convention Plaza, No. 1 Harbour
Road, Wanchai, Hong Kong.



[11] 1802383.2M007

[15] 03-12-2018

[30] 03-06-2018 / US / 29/649,906

[51] Cl. 14-04

[54] 用於電子裝置的圖形用戶界面

Graphical user interface for electronic device

[73] 蘋果公司

APPLE INC.

ONE APPLE PARK WAY, CUPERTINO, CALIFORNIA 95014,
UNITED STATES

[74] CLT Patent & Trademark (H.K.) Ltd.

Unit 09, 34/F., Office Tower, Convention Plaza, No. 1 Harbour
Road, Wanchai, Hong Kong.



[11] 1802383.2M008

[15] 03-12-2018

[30] 03-06-2018 / US / 29/649,906

[51] Cl. 14-04

[54] 用於電子裝置的圖形用戶界面

Graphical user interface for electronic device

[73] 蘋果公司

APPLE INC.

ONE APPLE PARK WAY, CUPERTINO, CALIFORNIA 95014,
UNITED STATES

[74] CLT Patent & Trademark (H.K.) Ltd.

Unit 09, 34/F., Office Tower, Convention Plaza, No. 1 Harbour
Road, Wanchai, Hong Kong.

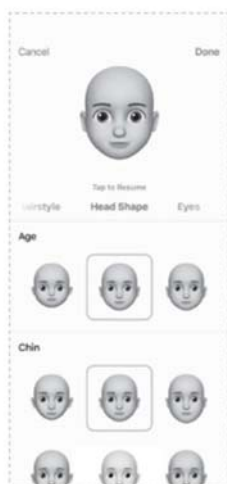

[11] 1802383.2M009

[15] 03-12-2018

[30] 03-06-2018 / US / 29/649,906

[51] Cl. 14-04

[54] 用於電子裝置的圖形用戶界面

Graphical user interface for electronic device

[73] 蘋果公司

APPLE INC.

ONE APPLE PARK WAY, CUPERTINO, CALIFORNIA 95014,
UNITED STATES

[74] CLT Patent & Trademark (H.K.) Ltd.

Unit 09, 34/F., Office Tower, Convention Plaza, No. 1 Harbour
Road, Wanchai, Hong Kong.

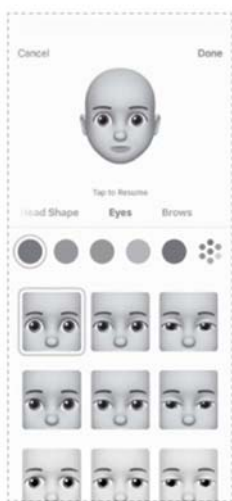

[11] 1802383.2M010

[15] 03-12-2018

[30] 03-06-2018 / US / 29/649,906

[51] Cl. 14-04

[54] 用於電子裝置的圖形用戶界面

Graphical user interface for electronic device

[73] 蘋果公司

APPLE INC.

ONE APPLE PARK WAY, CUPERTINO, CALIFORNIA 95014,
UNITED STATES

[74] CLT Patent & Trademark (H.K.) Ltd.

Unit 09, 34/F., Office Tower, Convention Plaza, No. 1 Harbour
Road, Wanchai, Hong Kong.



[11] 1802383.2M011

[15] 03-12-2018

[30] 03-06-2018 / US / 29/649,906

[51] Cl. 14-04

[54] 用於電子裝置的動態圖形用戶界面

Animated graphical user interface for electronic device

[73] 蘋果公司

APPLE INC.

ONE APPLE PARK WAY, CUPERTINO, CALIFORNIA 95014,

UNITED STATES

[74] CLT Patent & Trademark (H.K.) Ltd.

Unit 09, 34/F., Office Tower, Convention Plaza, No. 1 Harbour

Road, Wanchai, Hong Kong.



[11] 1802383.2M012

[15] 03-12-2018

[30] 03-06-2018 / US / 29/649,906

[51] Cl. 14-04

[54] 用於電子裝置的動態圖形用戶界面

Animated graphical user interface for electronic device

[73] 蘋果公司

APPLE INC.

ONE APPLE PARK WAY, CUPERTINO, CALIFORNIA 95014,
UNITED STATES

[74] CLT Patent & Trademark (H.K.) Ltd.

Unit 09, 34/F., Office Tower, Convention Plaza, No. 1 Harbour
Road, Wanchai, Hong Kong.

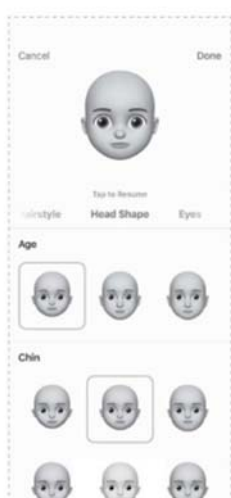

[11] 1802411.3

[15] 07-12-2018

[51] Cl. 26-05

[54] 流動夜燈

Portable night light

[73] 盧佩盈

Lou Pui Ying

香港將軍澳 厚德邨德

康樓 304 室

[74] 盧佩盈

香港將軍澳 厚德邨德

康樓 304 室



[11] 1802516.7

[15] 21-12-2018

[30] 10-12-2018 / EM / 005867512-0001

[51] Cl. 21-01

[54] 絨毛兔

Rabbit fluff

[73] T&C 荷蘭有限公司

T&C NEDERLAND B.V.

WILLIBRORDUSSTRAAT 12, 5087BS DIESEN,
NETHERLANDS

[74] CLT Patent & Trademark (H.K.) Ltd.

Unit 09, 34/F., Office Tower, Convention Plaza,
No. 1 Harbour Road, Wanchai
HONG KONG



[11] 1802556.1

[15] 28-12-2018

[30] 29-06-2018 / EM / 005332020-0001

[51] Cl. 10-04

[54] 酒精測試器

Alcohol meter

[73] Olythe

Les Méridiens - Bât B, 240,

Rue Louis de Broglie,

13100 AIX EN PROVENCE, FRANCE

[74] Nozo International Intellectual Property Co., Ltd

9B, Cheong Tai Commercial Building,

66 Wing Lok Street, Sheung Wan,

Hong Kong.

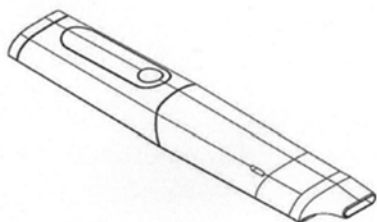

[11] 1802580.1

[15] 31-12-2018

[51] Cl. 21-01

[54] 拼裝玩具

Assembling toy

[73] 武漢億童文教股份有限公司

中國內地武漢市洪山區 青

菱都市工業園

青菱河路 18 號 1-108

[74] 港智國際知識產權代理有限公司

香港屯門

震寰路 3 號

德榮工業大廈 20 字樓 B6 室



[11] 1900001.3

[15] 02-01-2019

[30] 21-08-2018 / JP / 018113 of 2018

[51] Cl. 13-03

[54] 電器用電線保護器

Wire protector for electric appliance

[73] 麥克賽爾控股株式會社

MAXELL HOLDINGS, LTD.

日本京都府 乙訓郡

大山崎町 大山崎小

泉 1 番地

[74] 中國專利代理(香港)有限公司

香港灣仔

港灣道 23 號

鷹君中心 22 字樓

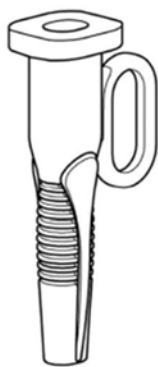

[11] 1900002.5M001

[15] 02-01-2019

[30] 03-07-2018 / EM / 005383007

[51] Cl. 2-04

[54] 鞋底

Shoe sole

[73] TOD'S S.P.A.

VIA FILIPPO DELLA VALLE 1,
I-63811 SANT'ELPIDIO A MARE (FERMO) ITALY,
ITALY

[74] China Patent Agent (H.K.) Ltd.

22/F, Great Eagle Centre,
23 Harbour Road, Wanchai,
Hong Kong.



[11] 1900002.5M002

[15] 02-01-2019

[30] 03-07-2018 / EM / 005383007

[51] Cl. 2-04

[54] 鞋底

Shoe sole

[73] TOD'S S.P.A.

VIA FILIPPO DELLA VALLE 1,
I-63811 SANT'ELPIDIO A MARE (FERMO) ITALY,
ITALY

[74] China Patent Agent (H.K.) Ltd.

22/F, Great Eagle Centre,
23 Harbour Road, Wanchai,
Hong Kong.



[11] 1900004.9

[15] 02-01-2019

[30] 11-07-2018 / JP / 015312 of 2018

[51] Cl. 13-03

- [54] 電器用電線保護器
Wire protector for electric appliance
- [73] 麥克賽爾控股株式會社
MAXELL HOLDINGS, LTD.
日本京都府乙訓郡 大山崎町大
山崎小泉 1 番地
- [74] 中國專利代理(香港)有限公司
香港灣仔
港灣道 23 號
鷹君中心 22 字樓

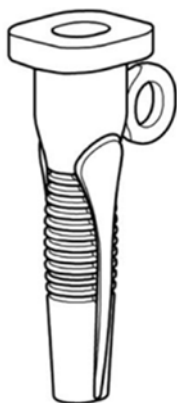

-
- [11] 1900028.0M001
- [15] 04-01-2019
- [30] 16-11-2018 / US / 29/670,580
- [51] Cl. 4-01
- [54] 牙刷
Toothbrush
- [73] World Wide Daily Holdings Company Limited
19/F., Koon Wah Mirror Factory 3rd Industrial Building,
5-9 Ka Hing Road, Kwai Chung,
New Territories, Hong Kong
- [74] MARKS & CLERK
Level 9, Cyberport 1,
100 Cyberport Road,
Pok Fu Lam, Hong Kong.



[11] 1900028.0M002

[15] 04-01-2019

[30] 16-11-2018 / US / 29/670,580

[51] Cl. 4-02

[54] 牙刷

Toothbrush

[73] World Wide Daily Holdings Company Limited
19/F., Koon Wah Mirror Factory 3rd Industrial Building,
5-9 Ka Hing Road, Kwai Chung,
New Territories, Hong Kong.

[74] MARKS & CLERK
Level 9, Cyberport 1,
100 Cyberport Road,
Pok Fu Lam, Hong Kong.



[11] 1900028.0M003

[15] 04-01-2019

[30] 16-11-2018 / US / 29/670,584

[51] Cl. 4-01

[54] 牙刷

Toothbrush

[73] World Wide Daily Holdings Company Limited
19/F., Koon Wah Mirror Factory 3rd Industrial Building,
5-9 Ka Hing Road, Kwai Chung,
New Territories, Hong Kong.

[74] MARKS & CLERK

Level 9, Cyberport 1,
100 Cyberport Road,
Pok Fu Lam, Hong Kong.



[11] 1900028.0M004

[15] 04-01-2019

[30] 16-11-2018 / US / 29/670,584

[51] Cl. 4-02

[54] 牙刷

Toothbrush

[73] World Wide Daily Holdings Company Limited
19/F., Koon Wah Mirror Factory 3rd Industrial Building,
5-9 Ka Hing Road, Kwai Chung,
New Territories, Hong Kong.

[74] MARKS & CLERK

Level 9, Cyberport 1,
100 Cyberport Road,
Pok Fu Lam, Hong Kong.



[11] 1913243.0

[15] 19-03-2019

[30] 25-02-2019 / CN / 201930075431.8

[51] Cl. 3-04

[54] 風扇

Fan

[73] 深圳市同創創精密電子有限公司

N/A

中國內地

深圳市寶安區西鄉街道 三圍華豐第一科技園 B 區一棟三樓、八樓北

[74] 金信智權有限公司

香港

觀塘偉業街 221 號 美德工業大

廈 D 座 10/F 38 室



[11] 1913304.0M001

[15] 26-03-2019

[51] Cl. 26-05

[54] 燈

Lamp

[73] C.G. Lighting Ltd.

Rm. 1601 Wanchai Commercial Centre, 194 Johnston Road,
Wanchai, Hong Kong

[74] C.G. Lighting Ltd.

Rm. 1601 Wanchai Commercial Centre, 194 Johnston Road,
Wanchai, Hong Kong

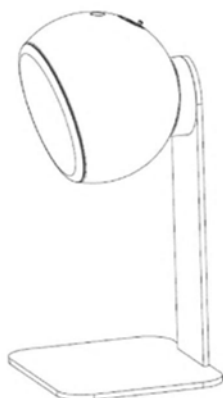

[11] 1913304.0M002

[15] 26-03-2019

[51] Cl. 26-05

[54] 燈

Lamp

[73] C.G. Lighting Ltd.

Rm. 1601 Wanchai Commercial Centre, 194 Johnston Road,
Wanchai, Hong Kong

[74] C.G. Lighting Ltd.

Rm. 1601 Wanchai Commercial Centre, 194 Johnston Road,
Wanchai, Hong Kong



[11] 1913304.0M003

[15] 26-03-2019

[51] Cl. 26-05

[54] 燈

Lamp

[73] C.G. Lighting Ltd.

Rm. 1601 Wanchai Commercial Centre, 194 Johnston Road,
Wanchai, Hong Kong

[74] C.G. Lighting Ltd.

Rm. 1601 Wanchai Commercial Centre, 194 Johnston Road,
Wanchai, Hong Kong



[11] 1913309.1

[15] 27-03-2019

[30] 27-09-2018 / EU / 005662384

[51] Cl. 23-04

[54] 空氣淨化器

Air purifier

[73] IAQ LABORATORY LIMITED

FLAT/RM 2002 20/F, KAI TAK COMMERCIAL BUILDING,
317-319 DES VOEUX ROAD CENTRAL, CENTRAL DISTRICT
HONG KONG

[74] CHINA PATENT AGENT (HONG KONG) LIMITED

22/F, Great Eagle Centre, 23 Harbour Road, Wanchai
HONG KONG

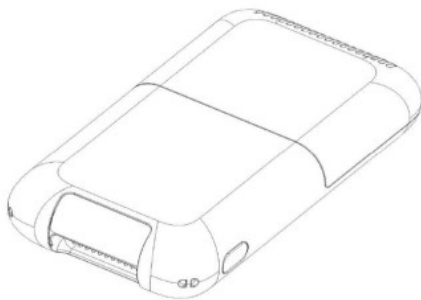

[11] 1913310.3

[15] 27-03-2019

[30] 25-10-2018 / DE / 40 2018 101 093.6

[51] Cl. 21-01

[54] 玩具汽車

Toy vehicle

[73] VOLKSWAGEN AKTIENGESELLSCHAFT

38436 WOLFSBURG
GERMANY

[74] CHINA PATENT AGENT (HONG KONG) LIMITED

22/F, Great Eagle Centre, 23 Harbour Road, Wanchai
HONG KONG



[11] 1913312.7M001

[15] 27-03-2019

[30] 18-01-2019 / EU, NO, KR, SG / WIPO79402

[51] Cl. 6-01

[54] 椅子
Chair

[73] Flokk AB
Vallgatan 1
571 23 Nässjö
SWEDEN

[74] BARRON & YOUNG INTELLECTUAL PROPERTY LIMITED
Suite 617, Lakeside 2
No. 10 Science Park West Avenue, Hong Kong Science Park,
Shatin, N.T.
HONG KONG



[11] 1913312.7M002

[15] 27-03-2019

[30] 18-01-2019 / EU, NO, KR, SG / WIPO79402

[51] Cl. 6-01

[54] 椅子
Chair

[73] Flokk AB
Vallgatan 1
571 23 Nässjö
SWEDEN

[74] BARRON & YOUNG INTELLECTUAL PROPERTY LIMITED
Suite 617, Lakeside 2
No. 10 Science Park West Avenue, Hong Kong Science Park,

Shatin, N.T.

HONG KONG



[11] 1913312.7M003

[15] 27-03-2019

[30] 18-01-2019 / EU, NO, KR, SG / WIPO79402

[51] Cl. 6-01

[54] 椅子
Chair

[73] Flokk AB
Vallgatan 1
571 23 Nässjö
SWEDEN

[74] BARRON & YOUNG INTELLECTUAL PROPERTY LIMITED
Suite 617, Lakeside 2
No. 10 Science Park West Avenue, Hong Kong Science Park,
Shatin, N.T.
HONG KONG



[11] 1913312.7M004

[15] 27-03-2019

[30] 18-01-2019 / EU, NO, KR, SG / WIPO79402

[51] Cl. 6-01

[54] 椅子
Chair

[73] Flokk AB
Vallgatan 1
571 23 Nässjö
SWEDEN

[74] BARRON & YOUNG INTELLECTUAL PROPERTY LIMITED
Suite 617, Lakeside 2
No. 10 Science Park West Avenue, Hong Kong Science Park,
Shatin, N.T.
HONG KONG



[11] 1913312.7M005

[15] 27-03-2019

[30] 18-01-2019 / EU, NO, KR, SG / WIPO79402

[51] Cl. 6-01

[54] 椅子
Chair

[73] Flokk AB
Vallgatan 1
571 23 Nässjö
SWEDEN

[74] BARRON & YOUNG INTELLECTUAL PROPERTY LIMITED
Suite 617, Lakeside 2
No. 10 Science Park West Avenue, Hong Kong Science Park,
Shatin, N.T.
HONG KONG



[11] 1913312.7M006

[15] 27-03-2019

[30] 18-01-2019 / EU, NO, KR, SG / WIPO79402

[51] Cl. 6-01

[54] 椅子
Chair

[73] Flokk AB
Vallgatan 1
571 23 Nässjö
SWEDEN

[74] BARRON & YOUNG INTELLECTUAL PROPERTY LIMITED
Suite 617, Lakeside 2
No. 10 Science Park West Avenue, Hong Kong Science Park,

Shatin, N.T.

HONG KONG



[11] 1913312.7M007

[15] 27-03-2019

[30] 18-01-2019 / EU, NO, KR, SG / WIPO79402

[51] Cl. 6-01

[54] 椅子
Chair

[73] Flokk AB
Vallgatan 1
571 23 Nässjö
SWEDEN

[74] BARRON & YOUNG INTELLECTUAL PROPERTY LIMITED
Suite 617, Lakeside 2
No. 10 Science Park West Avenue, Hong Kong Science Park,
Shatin, N.T.
HONG KONG



[11] 1913312.7M008

[15] 27-03-2019

[30] 18-01-2019 / EU, NO, KR, SG / WIPO79402

[51] Cl. 6-01

[54] 椅子
Chair

[73] Flokk AB
Vallgatan 1
571 23 Nässjö
SWEDEN

[74] BARRON & YOUNG INTELLECTUAL PROPERTY LIMITED
Suite 617, Lakeside 2
No. 10 Science Park West Avenue, Hong Kong Science Park,
Shatin, N.T.
HONG KONG



[11] 1913313.9M001

[15] 27-03-2019

[51] Cl. 23-04

[54] 香薰機

Aroma diffuser

[73] 璞真生活有限公司

Puzhen Life Co., Limited

Unit 1112-1116,11/F, Delta House,

3 On Yiu Street, Shatin

HONG KONG

[74] FEDERATION OF HONG KONG INDUSTRIES

31/F, Billion Plaza,

8 Cheung Yue Street, Cheung Sha Wan, Kowloon

HONG KONG

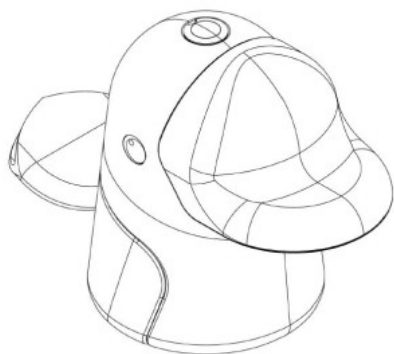

[11] 1913313.9M002

[15] 27-03-2019

[51] Cl. 23-04

[54] 香薰機

Aroma diffuser

[73] 璞真生活有限公司

Puzhen Life Co., Limited

Unit 1112-1116,11/F, Delta House,

3 On Yiu Street, Shatin

HONG KONG

[74] FEDERATION OF HONG KONG INDUSTRIES

31/F, Billion Plaza,

8 Cheung Yue Street, Cheung Sha Wan, Kowloon

HONG KONG

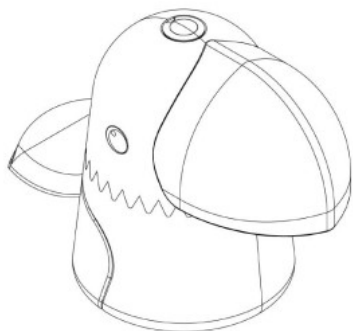

[11] 1913313.9M003

[15] 27-03-2019

[51] Cl. 23-04

[54] 香薰機

Aroma diffuser

[73] 璞真生活有限公司

Puzhen Life Co., Limited

Unit 1112-1116, 11/F, Delta House,

3 On Yiu Street, Shatin

HONG KONG

[74] FEDERATION OF HONG KONG INDUSTRIES

31/F, Billion Plaza,

8 Cheung Yue Street, Cheung Sha Wan, Kowloon

HONG KONG

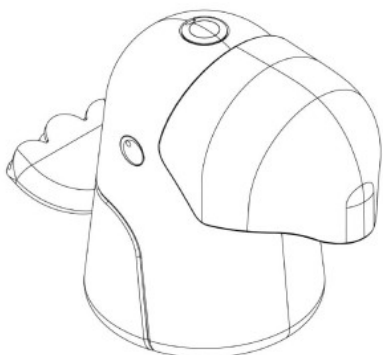

[11] 1913313.9M004

[15] 27-03-2019

[51] Cl. 23-04

[54] 香薰機

Aroma diffuser

[73] 璞真生活有限公司

Puzhen Life Co., Limited
Unit 1112-1116,11/F, Delta House,
3 On Yiu Street, Shatin
HONG KONG

[74] FEDERATION OF HONG KONG INDUSTRIES

31/F, Billion Plaza,
8 Cheung Yue Street, Cheung Sha Wan, Kowloon
HONG KONG



[11] 1913313.9M005

[15] 27-03-2019

[51] Cl. 23-04

[54] 香薰機

Aroma diffuser

[73] 璞真生活有限公司

Puzhen Life Co., Limited
Unit 1112-1116,11/F, Delta House,
3 On Yiu Street, Shatin
HONG KONG

[74] FEDERATION OF HONG KONG INDUSTRIES

31/F, Billion Plaza,
8 Cheung Yue Street, Cheung Sha Wan, Kowloon
HONG KONG

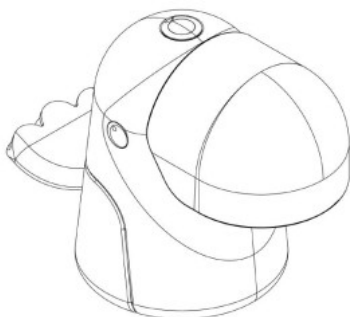

[11] 1913314.1

[15] 27-03-2019

[51] Cl. 28-03

[54] 美容儀器

Beauty apparatus

[73] 璞真生活有限公司

Puzhen Life Co., Limited

Unit 1112-1116, 11/F, Delta House,

3 On Yiu Street, Shatin

HONG KONG

[74] FEDERATION OF HONG KONG INDUSTRIES

31/F, Billion Plaza,

8 Cheung Yue Street, Cheung Sha Wan, Kowloon

HONG KONG

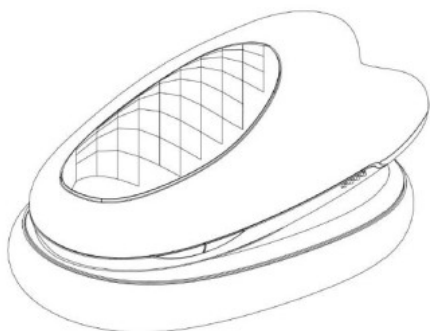

[11] 1913316.6M001

[15] 27-03-2019

[30] 12-02-2019 / EU, AZ, RS, AL, AM, GE, SG, UA, TR, RU /
970009839

[51] Cl. 9-02

[54] 罐

Can

[73] FrieslandCampina Nederland B.V.

Stationsplein 4

3818 LE AMERSFOORT

NETHERLANDS

[74] SO KEUNG YIP & SIN

Room 1009-1012, 10/F., Nan Fung Tower,

No. 173 Des Voeux Road Central

HONG KONG



[11] 1913316.6M002

[15] 27-03-2019

[30] 12-02-2019 / EU, AZ, RS, AL, AM, GE, SG, UA, TR, RU /
970009839

[51] Cl. 9-02

[54] 罐

Can

[73] FrieslandCampina Nederland B.V.
Stationsplein 4
3818 LE AMERSFOORT
NETHERLANDS

[74] SO KEUNG YIP & SIN
Room 1009-1012, 10/F., Nan Fung Tower,
No. 173 Des Voeux Road Central
HONG KONG



[11] 1913317.8

[15] 27-03-2019

[51] Cl. 26-02

[54] 提燈

Lantern

[73] 飛龍發展有限公司

FLYING DRAGON DEVELOPMENT LIMITED

UNIT B, 6/F., UNISON INDUSTRIAL CENTRE

27-31 AU PUI WAN STREET, FOTAN, SHATIN, N.T. HONG KONG

[74] BENNY KONG & TSAI

Unit 19B, Overseas Trust Bank Building

No. 160 Gloucester Road, Wanchai

HONG KONG

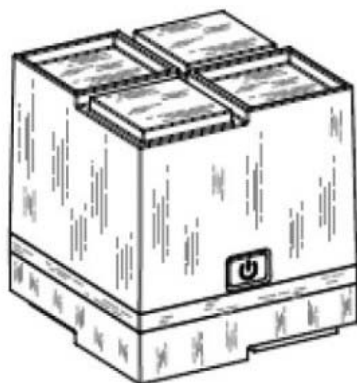

[11] 1913318.0M001

[15] 27-03-2019

[30] 27-09-2018 / US / 29/664,806

[51] Cl. 21-01

[54] 毛絨公仔

Plush Toy

[73] Two Tons Media, LLC

8117 W. Manchester Ave. #697

Playa Del Rey, CA 90293

UNITED STATES

[74] LETTERS & THOO LIMITED

Suite 1008, Prosperity Millennia Plaza,

663 King's Road, Quarry Bay

HONG KONG



[11] 1913318.0M002

[15] 27-03-2019

[30] 27-09-2018 / US / 29/664,806

[51] Cl. 21-01

[54] 毛絨公仔

Plush Toy

[73] Two Tons Media, LLC

8117 W. Manchester Ave. #697

Playa Del Rey, CA 90293

UNITED STATES

[74] LETTERS & THOO LIMITED

Suite 1008, Prosperity Millennia Plaza,

663 King's Road, Quarry Bay

HONG KONG



[11] 1913319.2M001

[15] 28-03-2019

[30] 27-11-2018 / US / 29/671,385

[51] Cl. 22-01

[54] 箭羽

Arrow vane

[73] BOHNING COMPANY, LTD.

7361 N. 7 MILE ROAD

LAKE CITY, MICHIGAN 49651

UNITED STATES

[74] CHINA PATENT AGENT (HONG KONG) LIMITED

22/F, Great Eagle Centre, 23 Harbour Road, Wanchai

HONG KONG

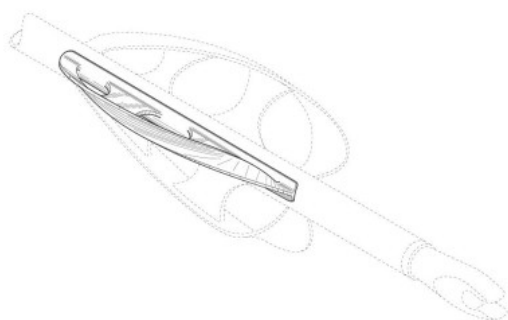

[11] 1913319.2M002

[15] 28-03-2019

[30] 27-11-2018 / US / 29/671,385

[51] Cl. 22-01

[54] 箭羽

Arrow vane

[73] BOHNING COMPANY, LTD.

7361 N. 7 MILE ROAD

LAKE CITY, MICHIGAN 49651

UNITED STATES

[74] CHINA PATENT AGENT (HONG KONG) LIMITED

22/F, Great Eagle Centre, 23 Harbour Road, Wanchai

HONG KONG

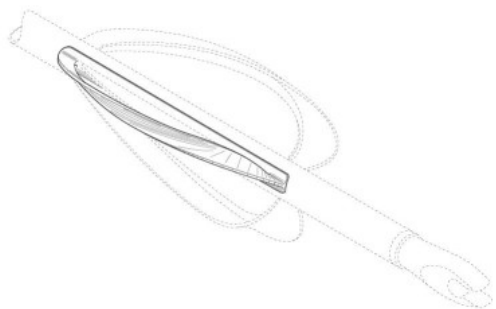

[11] 1913319.2M003

[15] 28-03-2019

[30] 19-02-2019 / US / 29/680,713

[51] Cl. 22-01

[54] 箭羽

Arrow vane

[73] BOHNING COMPANY, LTD.

7361 N. 7 MILE ROAD

LAKE CITY, MICHIGAN 49651

UNITED STATES

[74] CHINA PATENT AGENT (HONG KONG) LIMITED

22/F, Great Eagle Centre, 23 Harbour Road, Wanchai

HONG KONG

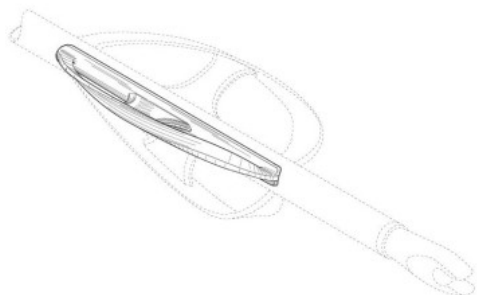

[11] 1913319.2M004

[15] 28-03-2019

[51] Cl. 22-01

[54] 箭羽

Arrow vane

[73] BOHNING COMPANY, LTD.

7361 N. 7 MILE ROAD

LAKE CITY, MICHIGAN 49651

UNITED STATES

[74] CHINA PATENT AGENT (HONG KONG) LIMITED
22/F, Great Eagle Centre, 23 Harbour Road, Wanchai
HONG KONG

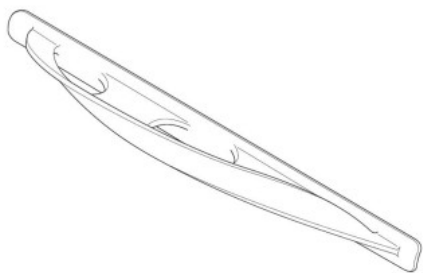

[11] 1913319.2M005

[15] 28-03-2019

[51] Cl. 22-01

[54] 箭羽

Arrow vane

[73] BOHNING COMPANY, LTD.
7361 N. 7 MILE ROAD
LAKE CITY, MICHIGAN 49651
UNITED STATES

[74] CHINA PATENT AGENT (HONG KONG) LIMITED
22/F, Great Eagle Centre, 23 Harbour Road, Wanchai
HONG KONG

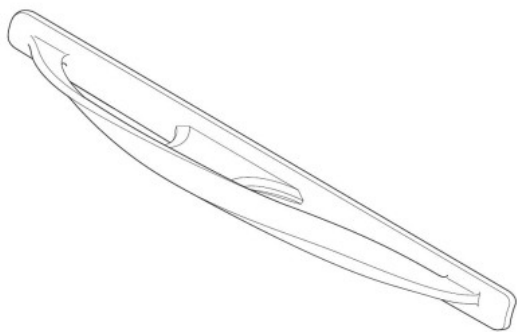

[11] 1913320.4

[15] 28-03-2019

[30] 25-10-2018 / DE / 40 2018 101 094.4

[51] Cl. 21-01

[54] 玩具汽車

Toy vehicle

[73] VOLKSWAGEN AKTIENGESELLSCHAFT
38436 WOLFSBURG
GERMANY

[74] CHINA PATENT AGENT (HONG KONG) LIMITED
22/F, Great Eagle Centre, 23 Harbour Road, Wanchai
HONG KONG



[11] 1913321.6M001

[15] 28-03-2019

[30] 25-10-2018 / DE / 40 2018 101 094.4

[51] C1. 12-08

[54] 汽車

MOTOR VEHICLE

[73] VOLKSWAGEN AKTIENGESELLSCHAFT
38436 WOLFSBURG
GERMANY

[74] CHINA PATENT AGENT (HONG KONG) LIMITED
22/F, Great Eagle Centre, 23 Harbour Road, Wanchai
HONG KONG



[11] 1913321.6M002

[15] 28-03-2019

[30] 25-10-2018 / DE / 40 2018 101 094.4

[51] C1. 12-08

[54] 汽車

MOTOR VEHICLE

[73] VOLKSWAGEN AKTIENGESELLSCHAFT

38436 WOLFSBURG

GERMANY

[74] CHINA PATENT AGENT (HONG KONG) LIMITED

22/F, Great Eagle Centre, 23 Harbour Road, Wanchai

HONG KONG



[11] 1913321.6M003

[15] 28-03-2019

[30] 25-10-2018 / DE / 40 2018 101 094.4

[51] Cl. 12-08

[54] 汽車

MOTOR VEHICLE

[73] VOLKSWAGEN AKTIENGESELLSCHAFT

38436 WOLFSBURG

GERMANY

[74] CHINA PATENT AGENT (HONG KONG) LIMITED

22/F, Great Eagle Centre, 23 Harbour Road, Wanchai

HONG KONG



[11] 1913322.8

[15] 28-03-2019

[51] Cl. 21-01

[54] 毛絨玩具、填充玩具
Plush toy, stuffed toy

[73] 庄育軍
CHONG YUK KWAN ANDY
香港
元朗青山公路潭尾段 18 號
峻巒 1B 第 7B 座 12 樓 A 室

[74] 庄育軍
香港
元朗青山公路潭尾段 18 號
峻巒 1B 第 7B 座 12 樓 A 室

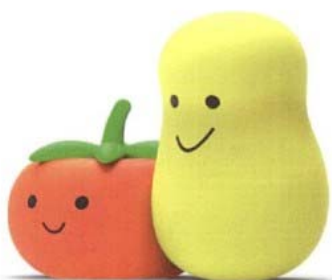

[11] 1913323.0

[15] 28-03-2019

[30] 31-10-2018 / JP / 2018-024027

[51] Cl. 28-03

[54] 鍛煉用器具
Training apparatus

[73] 株式會社 MTG
MTG Co., Ltd.
32, HONJIN-DORI 2-CHOME, NAKAMURA-KU, NAGOYA-SHI, AICHI-KEN
453-0041,
JAPAN

[74] CHINAHONGKONG IP LIMITED
3011, 30/F, Office Tower,
Convention Plaza, 1 Harbour Road,
HONG KONG

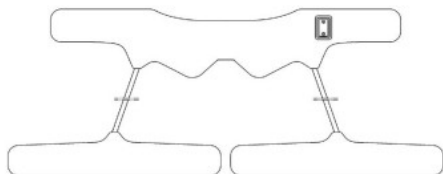

- [11] 1913324.2
[15] 28-03-2019
[30] 11-03-2019 / JP / 2019-004938
[51] Cl. 23-04
[54] Air conditioner
空氣調節器
[73] Nippon PMAC Co., Ltd
日本琵琶庫株式會社
日本
神奈川縣厚木市
飯山 3150 番地
[74] 誠通專利商標（香港）有限公司
香港
灣仔港灣道一號 會展廣場辦公
大樓 34 樓 09 室

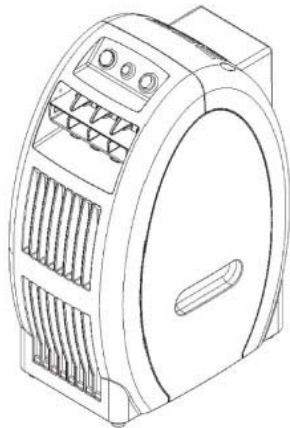

-
- [11] 1913325.5
[15] 28-03-2019
[51] Cl. 2-03
[54] 耳掛
Ear hook
[73] Artem Ansheles
Flat B, 1/F,
17A Java rd., North Point,
HONG KONG
[74] ACCOLADE IP LIMITED
10/F, Fu Fai Comm. Ctr.,
27 Hillier Street, Sheung Wan,
HONG KONG

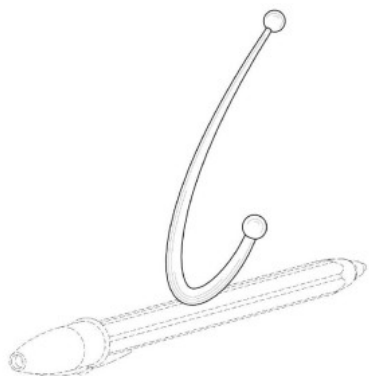

[11] 1913326.7M001

[15] 29-03-2019

[30] 29-09-2018 / EU / 005668522

[51] Cl. 31-00

[54] 食物處理器

Food processor

[73] Koninklijke Philips N.V.

High Tech Campus 5,

5656 AE, Eindhoven

NETHERLANDS

[74] WILKINSON & GRIST

6th Floor, Prince's Building

Chater Road

HONG KONG

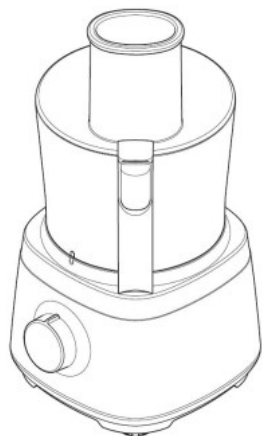

[11] 1913326.7M002

[15] 29-03-2019

[30] 29-09-2018 / EU / 005668522

[51] Cl. 31-00

[54] 食物處理器

Food processor

[73] Koninklijke Philips N.V.

High Tech Campus 5,

5656 AE, Eindhoven

NETHERLANDS

[74] WILKINSON & GRIST

6th Floor, Prince's Building

Chater Road

HONG KONG

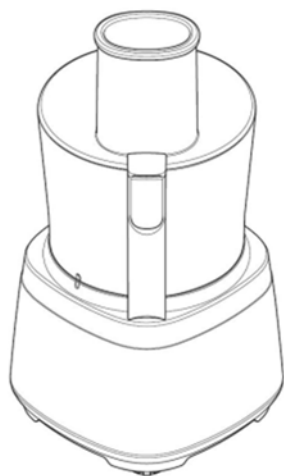

[11] 1913326.7M003

[15] 29-03-2019

[30] 29-09-2018 / EU / 005668522

[51] Cl. 31-00

[54] 食物處理器

Food processor

[73] Koninklijke Philips N.V.

High Tech Campus 5,

5656 AE, Eindhoven

NETHERLANDS

[74] WILKINSON & GRIST

6th Floor, Prince's Building

Chater Road

HONG KONG

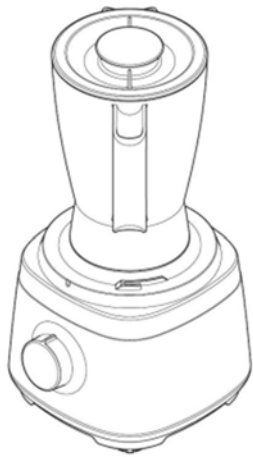

[11] 1913326.7M004

[15] 29-03-2019

[30] 29-09-2018 / EU / 005668522

[51] Cl. 31-00

[54] 食物處理器

Food processor

[73] Koninklijke Philips N.V.

High Tech Campus 5,

5656 AE, Eindhoven

NETHERLANDS

[74] WILKINSON & GRIST

6th Floor, Prince's Building

Chater Road

HONG KONG

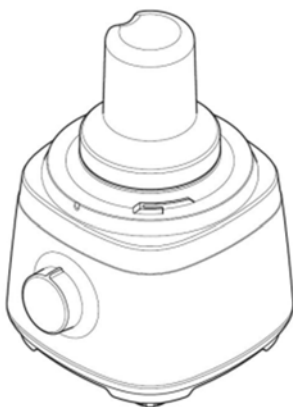

- [11] 1913326.7M005
[15] 29-03-2019
[30] 29-09-2018 / EU / 005668522
[51] Cl. 31-00
[54] 食物處理器
Food processor
[73] Koninklijke Philips N.V.
High Tech Campus 5,
5656 AE, Eindhoven
NETHERLANDS
[74] WILKINSON & GRIST
6th Floor, Prince's Building
Chater Road
HONG KONG



-
- [11] 1913328.1
[15] 29-03-2019
[30] 30-09-2018 / CN / 201830556787.9
[51] Cl. 14-03
[54] 手機
Mobile phone
[73] 華為技術有限公司
Huawei Technologies Co., Ltd.
中國內地 廣東省深
圳市龍崗區
坂田華為基地總部辦公樓 518129
[74] 香港柳沈知識產權服務公司
香港
灣仔港灣道 30 號
新鴻基中心 37 樓 3716 室



[11] 1913329.3

[15] 29-03-2019

[30] 30-09-2018 / CN / 201830556792.X

[51] Cl. 14-03

[54] 手機

Mobile phone

[73] 華為技術有限公司

Huawei Technologies Co., Ltd.

中國內地 廣東省深

圳市龍崗區

坂田華為基地總部辦公樓 518129

[74] 香港柳沈知識產權服務公司

香港

灣仔港灣道 30 號

新鴻基中心 37 樓 3716 室



- [11] 1913330.5
[15] 29-03-2019
[30] 10-10-2018 / JP / 2018 of 022226
[51] Cl. 23-01
[54] 噴頭
Shower head
[73] 麥克賽爾控股株式會社
MAXELL HOLDINGS, LTD.
日本 京都府乙
訓郡
大山崎町大山崎小泉 1 番地
[74] 中國專利代理(香港)有限公司
香港
灣仔港灣道 23 號
鷹君中心 22 字樓

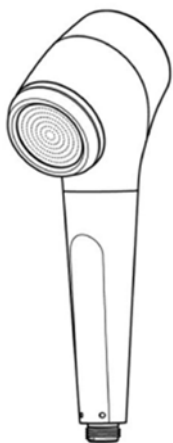

-
- [11] 1913332.9
[15] 01-04-2019
[51] Cl. 11-01
[54] 可調節手鐲
Adjustable bracelet
[73] 宜聖有限公司
Applause Contemporary Jewellery Limited
Flat B, 32/F, Kings Tower
111 King Lam Street, Cheung Sha Wan, Kowloon
HONG KONG
[74] GLOBAL INTELLECTUAL PROPERTY COMPANY LIMITED
Unit 2205, 22/F Sino Plaza,

255-257 Gloucester Road, Causeway Bay,
HONG KONG

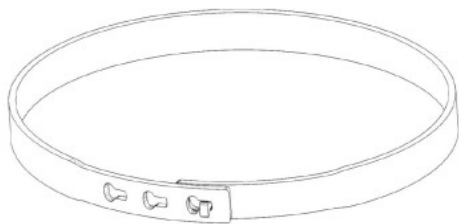

[11] 1913333.1

[15] 01-04-2019

[51] Cl. 3-01

[54] 書包

Schoolbag

[73] MO YUN TING

SUITE 4, 2/F, NEWPORT CENTRE,
116 MA TAU KOK ROAD,
HONG KONG

[74] MO YUN TING

SUITE 4, 2/F, NEWPORT CENTRE,
116 MA TAU KOK ROAD,
HONG KONG



[11] 1913335.6

[15] 01-04-2019

[30] 01-10-2018 / JP / 2018 of 021425

[51] Cl. 6-09

[54] 褥墊物料

Cushion material

[73] 西川株式會社

NISHIKAWA Co., Ltd.

8-8, Tomizawa-cho, Nihonbashi

Chuo-ku, Tokyo 103-0006

JAPAN

[74] WILKINSON & GRIST

6th Floor, Prince's Building

Chater Road

HONG KONG

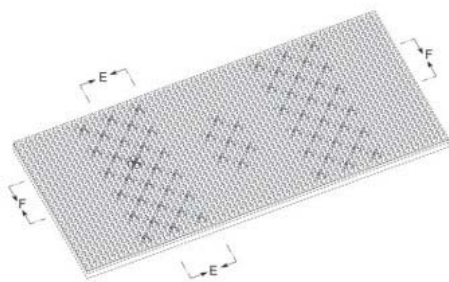

[11] 1913336.8

[15] 01-04-2019

[30] 02-10-2018 / JP / 2018 of 021571

[51] Cl. 28-03

[54] 美容滾輪器

Rollers for cosmetic purposes

[73] 株式會社 MTG

MTG Co., Ltd.

32, HONJIN-DORI 2-CHOME, NAKAMURA-KU, NAGOYA-SHI, AICHI-KEN

453-0041

JAPAN

[74] CHINAHONGKONG IP LIMITED

3011, 30/F, Office Tower, Convention Plaza, 1 Harbour Road

HONG KONG

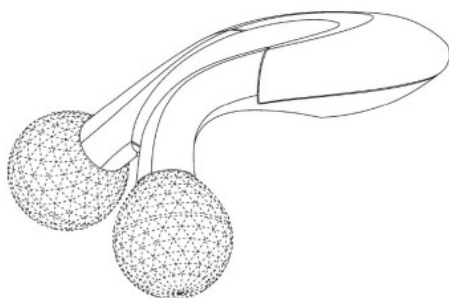

[11] 1913337.0

[15] 01-04-2019

[30] 02-10-2018 / JP / 2018 of 021568

[51] Cl. 28-03

[54] 美容滾輪器

Rollers for cosmetic purposes

[73] 株式會社 MTG

MTG Co., Ltd.

JAPAN

32, HONJIN-DORI 2-CHOME, NAKAMURA-KU, NAGOYA-SHI, AICHI-KEN

453-0041

[74] CHINAHONGKONG IP LIMITED

3011, 30/F, Office Tower, Convention Plaza, 1 Harbour Road

Hong Kong

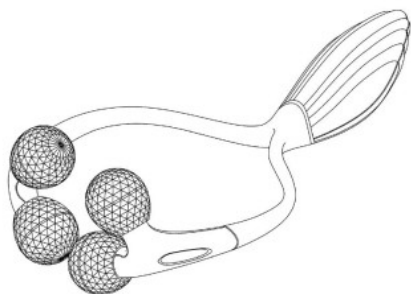

[11] 1913338.2

[15] 01-04-2019

[30] 03-10-2018 / EU, SG, CH / DM/103 170

[51] Cl. 10-07

[54] 錶面

Watch dial

[73] RICHEMONT INTERNATIONAL SA

Route des Biches 10

CH - 1752 Villars-sur-Glâne

SWITZERLAND

[74] WENPING & CO

1701 Tung Wai Commercial Building,

111 Gloucester Road,

HONG KONG



[11] 1913340.6

[15] 01-04-2019

[51] Cl. 9-05

[54] 食品包裝袋

Bag for food packing

[73] 晨達發展有限公司

Silver Dynamic Development Ltd

香港上環 海景

商業大廈 20 樓

2001 室

[74] 晨達發展有限公司

香港上環 海景商

業大廈

20 樓 2001 室



- [11] 1913341.8
[15] 01-04-2019
[30] 17-09-2018 / CN / 201830542496.4
[51] Cl. 15-05
[54] 蒸熨機
A steaming and ironing machine
[73] 陳鍾鴻
香港油塘
高輝道 17 號
油塘工業城 A2 座 13 樓 1313-16 室
[74] 卓遠知識產權有限公司
香港
上環禧利街 27 號
富輝商業中心 10 樓



-
- [11] 1913342.0M001
[15] 02-04-2019
[30] 09-10-2018 / US / 29/666,054
[51] Cl. 24-01
[54] 血糖儀
Glucose meter
[73] F. HOFFMANN-LA ROCHE AG
GRENZACHERSTRASSE 124,
CH-4070 BASEL,
SWITZERLAND
[74] CHINA PATENT AGENT (HONG KONG) LIMITED
22/F, Great Eagle Centre, 23 Harbour Road, Wanchai
HONG KONG

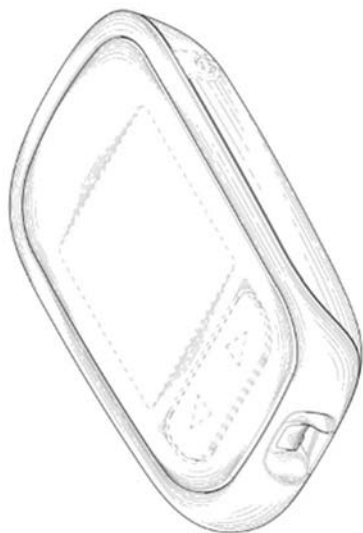

[11] 1913342.0M002

[15] 02-04-2019

[30] 09-10-2018 / US / 29/666,054

[51] Cl. 24-01

[54] 血糖儀

Glucose meter

[73] F. HOFFMANN-LA ROCHE AG

GRENZACHERSTRASSE 124,

CH-4070 BASEL,

SWITZERLAND

[74] CHINA PATENT AGENT (HONG KONG) LIMITED

22/F, Great Eagle Centre, 23 Harbour Road, Wanchai

HONG KONG

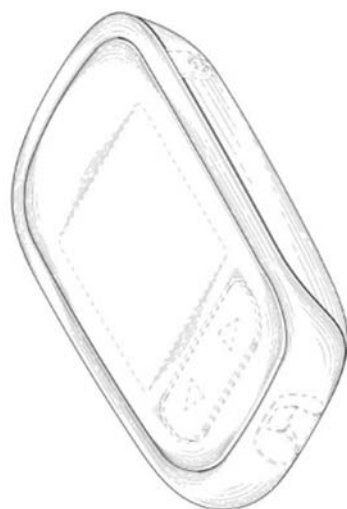

[11] 1913342.0M003

[15] 02-04-2019

[30] 09-10-2018 / US / 29/666,054

[51] Cl. 24-01

[54] 血糖儀

Glucose meter

[73] F. HOFFMANN-LA ROCHE AG

GRENZACHERSTRASSE 124,

CH-4070 BASEL,

SWITZERLAND

[74] CHINA PATENT AGENT (HONG KONG) LIMITED

22/F, Great Eagle Centre, 23 Harbour Road, Wanchai

HONG KONG

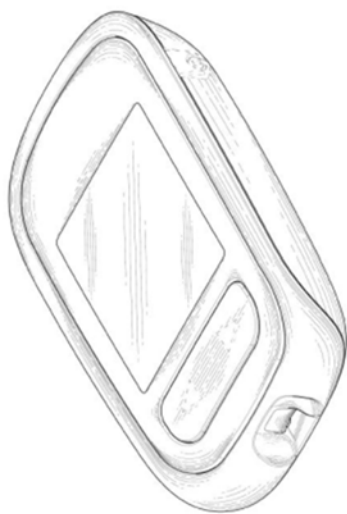

[11] 1913343.2M001

[15] 02-04-2019

[51] Cl. 11-01

[54] 飾物設計

Ornament Design

[73] 六福集團有限公司

Luk Fook Holdings Company Limited

Floor 15, 20, 25 & 27, Metropole Square,

No.2 On Yiu Street, Shatin, New Territories,

HONG KONG

[74] Luk Fook Holdings Company Limited

(Legal Affairs Department)

Floor 25, Metropole Square

No.2 On Yiu Street, Shatin, New Territories,

HONG KONG



[11] 1913343.2M002

[15] 02-04-2019

[51] Cl. 11-01

[54] 飾物設計

Ornament Design

[73] 六福集團有限公司

Luk Fook Holdings Company Limited
Floor 15, 20, 25 & 27, Metropole Square,
No.2 On Yiu Street, Shatin, New Territories,
HONG KONG

[74] Luk Fook Holdings Company Limited

(Legal Affairs Department)

Floor 25, Metropole Square

No.2 On Yiu Street, Shatin, New Territories,
HONG KONG



[11] 1913343.2M003

[15] 02-04-2019

[51] Cl. 11-01

[54] 飾物設計

Ornament Design

[73] 六福集團有限公司

Luk Fook Holdings Company Limited
Floor 15, 20, 25 & 27, Metropole Square,
No.2 On Yiu Street, Shatin, New Territories,
HONG KONG

[74] Luk Fook Holdings Company Limited

(Legal Affairs Department)

Floor 25, Metropole Square
No.2 On Yiu Street, Shatin, New Territories,
HONG KONG



[11] 1913343.2M004

[15] 02-04-2019

[51] Cl. 11-01

[54] 飾物設計

Ornament Design

[73] 六福集團有限公司

Luk Fook Holdings Company Limited
Floor 15, 20, 25 & 27, Metropole Square,
No.2 On Yiu Street, Shatin, New Territories,
HONG KONG

[74] Luk Fook Holdings Company Limited

(Legal Affairs Department)

Floor 25, Metropole Square
No.2 On Yiu Street, Shatin, New Territories,
HONG KONG



[11] 1913343.2M005

[15] 02-04-2019

[51] Cl. 11-01

[54] 飾物設計

Ornament Design

[73] 六福集團有限公司

Luk Fook Holdings Company Limited
Floor 15, 20, 25 & 27, Metropole Square,
No.2 On Yiu Street, Shatin, New Territories,
HONG KONG

[74] Luk Fook Holdings Company Limited

(Legal Affairs Department)
Floor 25, Metropole Square
No.2 On Yiu Street, Shatin, New Territories,
HONG KONG



[11] 1913343.2M006

[15] 02-04-2019

[51] Cl. 11-01

[54] 飾物設計

Ornament Design

[73] 六福集團有限公司

Luk Fook Holdings Company Limited

Floor 15, 20, 25 & 27, Metropole Square,

No.2 On Yiu Street, Shatin, New Territories,

HONG KONG

[74] Luk Fook Holdings Company Limited

(Legal Affairs Department)

Floor 25, Metropole Square

No.2 On Yiu Street, Shatin, New Territories,

HONG KONG



[11] 1913343.2M007

[15] 02-04-2019

[51] Cl. 11-01

[54] 飾物設計

Ornament Design

[73] 六福集團有限公司

Luk Fook Holdings Company Limited

Floor 15, 20, 25 & 27, Metropole Square,

No.2 On Yiu Street, Shatin, New Territories,

HONG KONG

[74] Luk Fook Holdings Company Limited

(Legal Affairs Department)

Floor 25, Metropole Square

No.2 On Yiu Street, Shatin, New Territories,

HONG KONG



[11] 1913343.2M008

[15] 02-04-2019

[51] Cl. 11-01

[54] 飾物設計

Ornament Design

[73] 六福集團有限公司

Luk Fook Holdings Company Limited
Floor 15, 20, 25 & 27, Metropole Square,
No.2 On Yiu Street, Shatin, New Territories,
HONG KONG

[74] Luk Fook Holdings Company Limited

(Legal Affairs Department)
Floor 25, Metropole Square
No.2 On Yiu Street, Shatin, New Territories,
HONG KONG

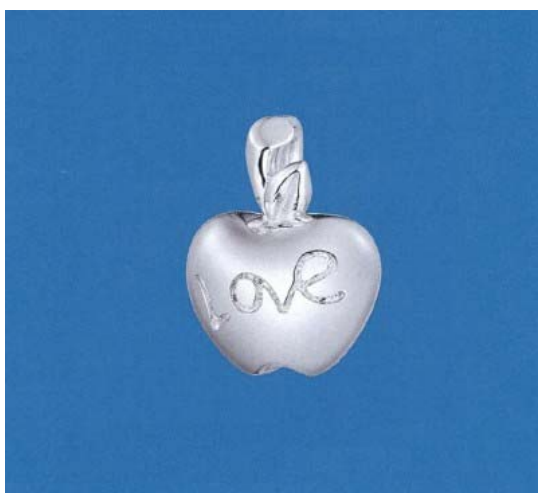

[11] 1913343.2M009

[15] 02-04-2019

[51] Cl. 11-01

[54] 飾物設計

Ornament Design

[73] 六福集團有限公司

Luk Fook Holdings Company Limited

Floor 15, 20, 25 & 27, Metropole Square,

No.2 On Yiu Street, Shatin, New Territories,

HONG KONG

[74] Luk Fook Holdings Company Limited

(Legal Affairs Department)

Floor 25, Metropole Square

No.2 On Yiu Street, Shatin, New Territories,

HONG KONG



[11] 1913343.2M010

[15] 02-04-2019

[51] Cl. 11-01

[54] 飾物設計

Ornament Design

[73] 六福集團有限公司

Luk Fook Holdings Company Limited

Floor 15, 20, 25 & 27, Metropole Square,

No.2 On Yiu Street, Shatin, New Territories,

HONG KONG

[74] Luk Fook Holdings Company Limited

(Legal Affairs Department)

Floor 25, Metropole Square

No.2 On Yiu Street, Shatin, New Territories,

HONG KONG



[11] 1913343.2M011

[15] 02-04-2019

[51] Cl. 11-01

[54] 飾物設計

Ornament Design

[73] 六福集團有限公司

Luk Fook Holdings Company Limited
Floor 15, 20, 25 & 27, Metropole Square,
No.2 On Yiu Street, Shatin, New Territories,
HONG KONG

[74] Luk Fook Holdings Company Limited

(Legal Affairs Department)
Floor 25, Metropole Square
No.2 On Yiu Street, Shatin, New Territories,
HONG KONG



[11] 1913343.2M012

[15] 02-04-2019

[51] Cl. 11-01

[54] 飾物設計

Ornament Design

[73] 六福集團有限公司

Luk Fook Holdings Company Limited

Floor 15, 20, 25 & 27, Metropole Square,

No.2 On Yiu Street, Shatin, New Territories,

HONG KONG

[74] Luk Fook Holdings Company Limited

(Legal Affairs Department)

Floor 25, Metropole Square

No.2 On Yiu Street, Shatin, New Territories,

HONG KONG



[11] 1913344.4M001

[15] 02-04-2019

[30] 03-10-2018 / EU / 005717006

[51] Cl. 24-02

[54] 用於注射的注射器組件

Component of syringe for injection

[73] OROFINO PHARMACEUTICALS GROUP S.R.L.

Via Paolo Mercuri

8 - I-00193 Roma

ITALY

[74] BARRON & YOUNG INTELLECTUAL PROPERTY LIMITED

Suite 617, Lakeside 2

No. 10 Science Park West Avenue, Hong Kong Science Park,

Shatin, N.T.

HONG KONG

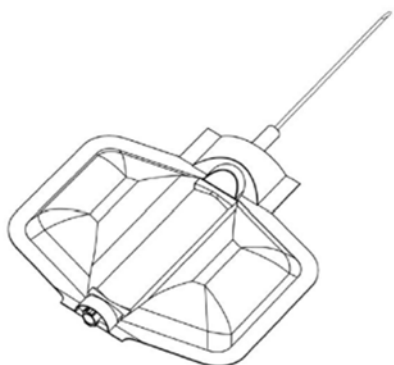

[11] 1913344.4M002

[15] 02-04-2019

[30] 03-10-2018 / EU / 005717006

[51] Cl. 24-02

[54] 用於注射的注射器組件

Component of syringe for injection

[73] OROFINO PHARMACEUTICALS GROUP S.R.L.

Via Paolo Mercuri

8 - I-00193 Roma

ITALY

[74] BARRON & YOUNG INTELLECTUAL PROPERTY LIMITED

Suite 617, Lakeside 2

No. 10 Science Park West Avenue, Hong Kong Science Park,
Shatin, N.T.

HONG KONG

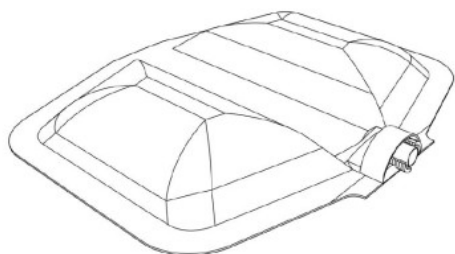

[11] 1913344.4M003

- [15] 02-04-2019
- [30] 03-10-2018 / EU / 005717006
- [51] Cl. 24-02
- [54] 用於注射的注射器組件
Component of syringe for injection
- [73] OROFINO PHARMACEUTICALS GROUP S.R.L.
Via Paolo Mercuri
8 - I-00193 Roma
ITALY
- [74] BARRON & YOUNG INTELLECTUAL PROPERTY LIMITED
Suite 617, Lakeside 2
No. 10 Science Park West Avenue, Hong Kong Science Park,
Shatin, N.T.
HONG KONG



-
- [11] 1913344.4M004
- [15] 02-04-2019
- [30] 03-10-2018 / EU / 005717006
- [51] Cl. 24-02
- [54] 用於注射的注射器組件
Component of syringe for injection
- [73] OROFINO PHARMACEUTICALS GROUP S.R.L.
Via Paolo Mercuri
8 - I-00193 Roma
ITALY
- [74] BARRON & YOUNG INTELLECTUAL PROPERTY LIMITED
Suite 617, Lakeside 2
No. 10 Science Park West Avenue, Hong Kong Science Park,
Shatin, N.T.
HONG KONG



[11] 1913344.4M005

[15] 02-04-2019

[30] 03-10-2018 / EU / 005717006

[51] Cl. 24-02

[54] 注射器柱塞

Syringe plunger

[73] OROFINO PHARMACEUTICALS GROUP S.R.L.

Via Paolo Mercuri

8 - I-00193 Roma

ITALY

[74] BARRON & YOUNG INTELLECTUAL PROPERTY LIMITED

Suite 617, Lakeside 2

No. 10 Science Park West Avenue, Hong Kong Science Park,

Shatin, N.T.

HONG KONG



[11] 1913356.0

[15] 03-04-2019

[51] Cl. 11-01

[54] 飾物設計

Ornament design

[73] 金至尊國際有限公司

3D-GOLD INTERNATIONAL COMPANY LIMITED
UNITS 01-09, 17TH FLOOR, PENINSULA SQUARE,
NO. 18 SUNG ON STREET, HUNGHOM,
KOWLOON, HONG KONG

[74] 3D- GOLD INTERNATIONAL COMPANY LIMITED(ATTN TO IRENE CHEUNG)

UNITS 01-09, 17TH FLOOR, PENINSULA SQUARE,
NO. 18 SUNG ON STREET, HUNGHOM,
KOWLOON.HONG KONG

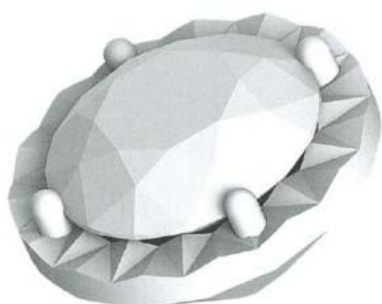

[11] 1913357.2M001

[15] 03-04-2019

[51] Cl. 11-01

[54] 飾物設計

Ornament Design

[73] 金至尊國際有限公司

3D-GOLD INTERNATIONAL COMPANY LIMITED
UNITS 01- 09, 17TH FLOOR, PENINSULA SQUARE,
NO.18 SUNG ON STREET, HUNGHOM, KOWLOON, HONG KONG

[74] 3D-GOLD INTERNATIONAL COMPANY LIMITED (ATTN TO IRENE CHEUNG)

UNITS 01-09, 17TH FLOOR, PENINSULA SQUARE,
NO. 18 SUNG ON STREET, HUNGHOM,
KOWLOON, HONG KONG

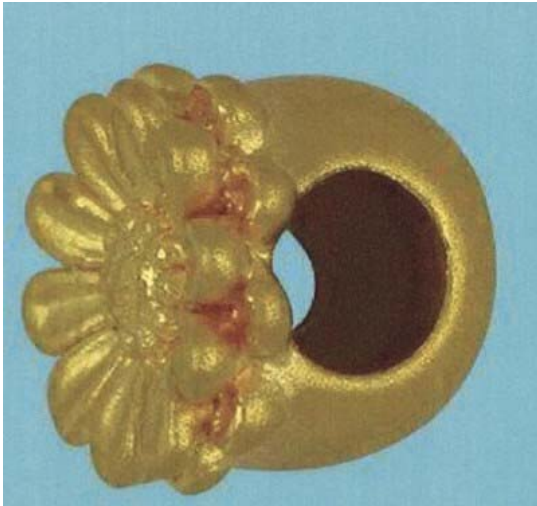

[11] 1913357.2M002

[15] 03-04-2019

[51] Cl. 11-01

[54] 飾物設計

Ornament Design

[73] 金至尊國際有限公司

3D-GOLD INTERNATIONAL COMPANY LIMITED
UNITS 01- 09, 17TH FLOOR, PENINSULA SQUARE,
NO.18 SUNG ON STREET, HUNGHOM, KOWLOON, HONG KONG

[74] 3D-GOLD INTERNATIONAL COMPANY LIMITED (ATTN TO IRENE CHEUNG)

UNITS 01-09, 17TH FLOOR, PENINSULA SQUARE,
NO. 18 SUNG ON STREET, HUNGHOM,
KOWLOON, HONG KONG



[11] 1913357.2M003

[15] 03-04-2019

[51] Cl. 11-01

[54] 飾物設計

Ornament Design

[73] 金至尊國際有限公司

3D-GOLD INTERNATIONAL COMPANY LIMITED
UNITS 01- 09, 17TH FLOOR, PENINSULA SQUARE,
NO.18 SUNG ON STREET, HUNGHOM, KOWLOON, HONG KONG

[74] 3D-GOLD INTERNATIONAL COMPANY LIMITED (ATTN TO IRENE CHEUNG)

UNITS 01-09, 17TH FLOOR, PENINSULA SQUARE,
NO. 18 SUNG ON STREET, HUNGHOM,
KOWLOON, HONG KONG



[11] 1913357.2M004

[15] 03-04-2019

[51] Cl. 11-01

[54] 飾物設計

Ornament Design

[73] 金至尊國際有限公司

3D-GOLD INTERNATIONAL COMPANY LIMITED
UNITS 01- 09, 17TH FLOOR, PENINSULA SQUARE,
NO.18 SUNG ON STREET, HUNGHOM, KOWLOON, HONG KONG

[74] 3D-GOLD INTERNATIONAL COMPANY LIMITED (ATTN TO IRENE CHEUNG)

UNITS 01-09, 17TH FLOOR, PENINSULA SQUARE,
NO. 18 SUNG ON STREET, HUNGHOM,
KOWLOON, HONG KONG



[11] 1913357.2M005

[15] 03-04-2019

[51] Cl. 11-01

[54] 飾物設計

Ornament Design

[73] 金至尊國際有限公司

3D-GOLD INTERNATIONAL COMPANY LIMITED

UNITS 01- 09, 17TH FLOOR, PENINSULA SQUARE,

NO.18 SUNG ON STREET, HUNGHOM, KOWLOON, HONG KONG

[74] 3D-GOLD INTERNATIONAL COMPANY LIMITED (ATTN TO IRENE CHEUNG)

UNITS 01-09, 17TH FLOOR, PENINSULA SQUARE,

NO. 18 SUNG ON STREET, HUNGHOM,

KOWLOON, HONG KONG



[11] 1913357.2M006

[15] 03-04-2019

[51] Cl. 11-01

[54] 飾物設計

Ornament Design

[73] 金至尊國際有限公司

3D-GOLD INTERNATIONAL COMPANY LIMITED

UNITS 01- 09, 17TH FLOOR, PENINSULA SQUARE,

NO.18 SUNG ON STREET, HUNGHOM, KOWLOON, HONG KONG

[74] 3D-GOLD INTERNATIONAL COMPANY LIMITED (ATTN TO IRENE CHEUNG)

UNITS 01-09, 17TH FLOOR, PENINSULA SQUARE,

NO. 18 SUNG ON STREET, HUNGHOM,

KOWLOON, HONG KONG

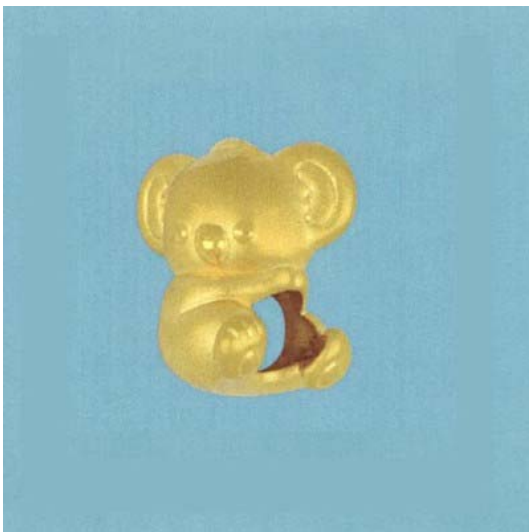

[11] 1913357.2M007

[15] 03-04-2019

[51] Cl. 11-01

[54] 飾物設計

Ornament Design

[73] 金至尊國際有限公司

3D-GOLD INTERNATIONAL COMPANY LIMITED

UNITS 01- 09, 17TH FLOOR, PENINSULA SQUARE,

NO.18 SUNG ON STREET, HUNGHOM, KOWLOON, HONG KONG

[74] 3D-GOLD INTERNATIONAL COMPANY LIMITED (ATTN TO IRENE CHEUNG)

UNITS 01-09, 17TH FLOOR, PENINSULA SQUARE,

NO. 18 SUNG ON STREET, HUNGHOM,

KOWLOON, HONG KONG



[11] 1913357.2M008

[15] 03-04-2019

[51] Cl. 11-01

[54] 飾物設計

Ornament Design

[73] 金至尊國際有限公司

3D-GOLD INTERNATIONAL COMPANY LIMITED
UNITS 01- 09, 17TH FLOOR, PENINSULA SQUARE,
NO.18 SUNG ON STREET, HUNGHOM, KOWLOON, HONG KONG

[74] 3D-GOLD INTERNATIONAL COMPANY LIMITED (ATTN TO IRENE CHEUNG)

UNITS 01-09, 17TH FLOOR, PENINSULA SQUARE,
NO. 18 SUNG ON STREET, HUNGHOM,
KOWLOON, HONG KONG



[11] 1913358.4M001

[15] 03-04-2019

[51] Cl. 11-01

[54] 飾物設計

Ornament Design

[73] 金至尊國際有限公司

3D-GOLD INTERNATIONAL COMPANY LIMITED

UNITS 01-09, 17TH FLOOR, PENINSULA SQUARE,

NO.18 SUNG ON STREET, HUNGHOM, KOWLOON, HONG KONG

,

[74] 3D-GOLD INTERNATIONAL COMPANY LIMITED (ATTN TO IRENE CHEUNG)

UNITS 01-09, 17TH FLOOR, PENINSULA SQUARE,

NO.18 SUNG ON STREET, HUNGHOM, KOWLOON, HONG KONG

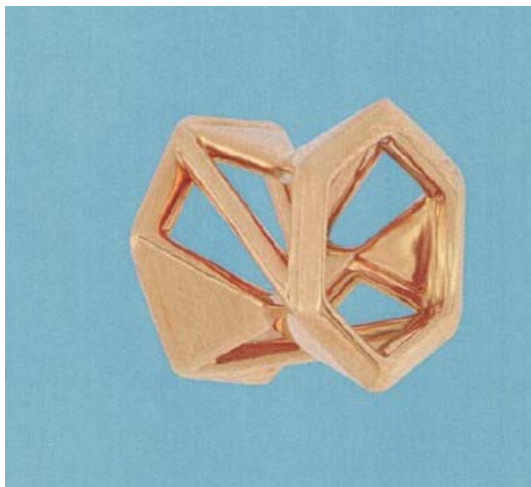

[11] 1913358.4M002

[15] 03-04-2019

[51] Cl. 11-01

[54] 飾物設計

Ornament Design

[73] 金至尊國際有限公司

3D-GOLD INTERNATIONAL COMPANY LIMITED

UNITS 01-09, 17TH FLOOR, PENINSULA SQUARE,

NO.18 SUNG ON STREET, HUNGHOM, KOWLOON, HONG KONG

,

[74] 3D-GOLD INTERNATIONAL COMPANY LIMITED (ATTN TO IRENE CHEUNG)

UNITS 01-09, 17TH FLOOR, PENINSULA SQUARE,

NO.18 SUNG ON STREET, HUNGHOM, KOWLOON, HONG KONG



[11] 1913358.4M003

[15] 03-04-2019

[51] Cl. 11-01

[54] 飾物設計

Ornament Design

[73] 金至尊國際有限公司

3D-GOLD INTERNATIONAL COMPANY LIMITED

UNITS 01-09, 17TH FLOOR, PENINSULA SQUARE,

NO.18 SUNG ON STREET, HUNGHOM, KOWLOON, HONG KONG

,

[74] 3D-GOLD INTERNATIONAL COMPANY LIMITED (ATTN TO IRENE CHEUNG)

UNITS 01-09, 17TH FLOOR, PENINSULA SQUARE,

NO.18 SUNG ON STREET, HUNGHOM, KOWLOON, HONG KONG

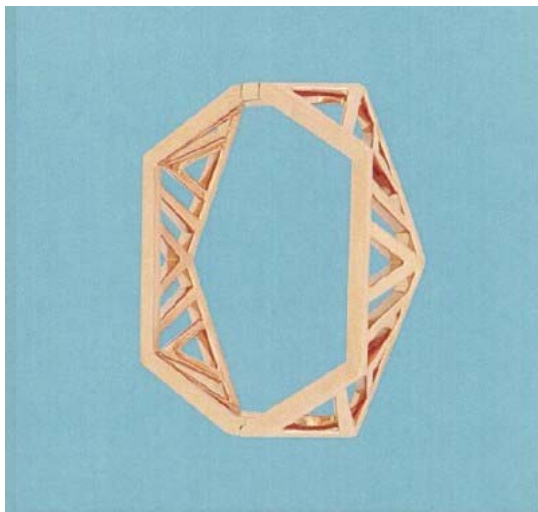

[11] 1913358.4M004

[15] 03-04-2019

[51] Cl. 11-01

[54] 飾物設計

Ornament Design

[73] 金至尊國際有限公司

3D-GOLD INTERNATIONAL COMPANY LIMITED

UNITS 01-09, 17TH FLOOR, PENINSULA SQUARE,

NO.18 SUNG ON STREET, HUNGHOM, KOWLOON, HONG KONG

,

[74] 3D-GOLD INTERNATIONAL COMPANY LIMITED (ATTN TO IRENE CHEUNG)

UNITS 01-09, 17TH FLOOR, PENINSULA SQUARE,

NO.18 SUNG ON STREET, HUNGHOM, KOWLOON, HONG KONG

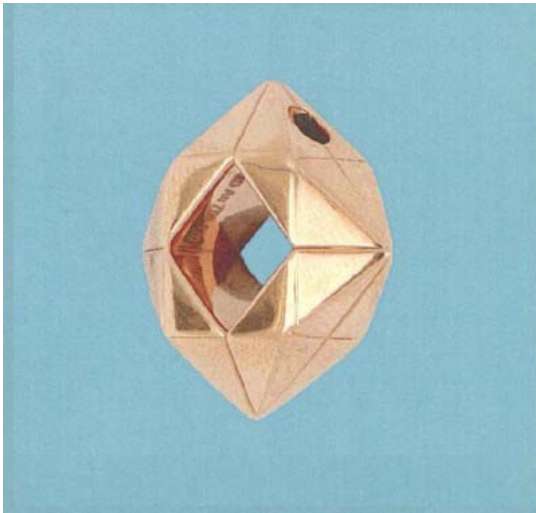

[11] 1913358.4M005

[15] 03-04-2019

[51] Cl. 11-01

[54] 飾物設計

Ornament Design

[73] 金至尊國際有限公司

3D-GOLD INTERNATIONAL COMPANY LIMITED

UNITS 01-09, 17TH FLOOR, PENINSULA SQUARE,

NO.18 SUNG ON STREET, HUNGHOM, KOWLOON, HONG KONG

,

[74] 3D-GOLD INTERNATIONAL COMPANY LIMITED (ATTN TO IRENE CHEUNG)

UNITS 01-09, 17TH FLOOR, PENINSULA SQUARE,

NO.18 SUNG ON STREET, HUNGHOM, KOWLOON, HONG KONG





香港特別行政區政府知識產權署外觀設計註冊處

The Government of the Hong Kong Special Administrative Region

Designs Registry, Intellectual Property Department

根據註冊外觀設計條例第28條，下列註冊外觀設計因未繳續期費而停止有效。各組記項按註冊外觀設計停止有效日期及註冊編號先後次序排列。

Registered designs ceased through non-payment of renewal fees under section 28 of the Registered Designs Ordinance. Entries are listed below under their expiry dates.

16-08-2019 - 21-08-2019

16-08-2019	9911084.7	1401568.1
0411819.4M001		1401569.3
0901307.1	19-08-2019	1401571.7
	0901340.0	
17-08-2019	0901347.5	21-08-2019
0411822.0M001	0901348.7	1401575.6M001
0411822.0M002	1401546.5M001	1401575.6M002
0411822.0M003	1401546.5M002	1401575.6M004
0901318.4M001	1401546.5M003	1401578.2
0901318.4M002	1401548.9	1401579.4
0901318.4M003	1401549.1	
0901325.9M001	1401550.3M001	
0901325.9M003	1401553.9	
1401527.5M001	1401555.4	
1401527.5M002	1401557.8	
1401527.5M005	1401558.0	
1401529.9M001	1401559.2	
1401529.9M002	1401560.4	
1401530.1	1401561.6M003	
1401531.3	1401561.6M004	
1401532.5		
1401533.7	20-08-2019	
	0901358.8M001	
18-08-2019	0901358.8M002	
0411827.1M001	1401562.8	
0411827.1M002	1401563.0	
1401535.2	1401564.2	
1401537.6M001	1401565.5	
1401537.6M002	1401566.7M001	
1401538.8	1401566.7M002	
1401539.0	1401566.7M003	
1401540.2	1401566.7M004	
1401541.4	1401567.9M001	
1401543.8	1401567.9M002	



香港特別行政區政府知識產權署外觀設計註冊處

The Government of the Hong Kong Special Administrative Region

Designs Registry, Intellectual Property Department

根據註冊外觀設計規則第 31 條刪除的註冊外觀設計。各組記項按註冊外觀設計 刪除日期及註冊編號先後次序排列。

Registered designs removed under section 31 of the Registered Designs Rules. Entries are listed below under their removal dates.

23-08-2019 - 29-08-2019

23-08-2019

0410305.3M001

0410305.3M002

0900245.8M001

27-08-2019

1400290.9

1400291.1

1400292.3

1400293.5

1400294.7

1400296.2

1400297.4

1400298.6M001

1400298.6M002

1400300.2

1400301.4

24-08-2019

1400270.7

1400272.1M001

1400272.1M002

1400273.3

1400274.5

25-08-2019

0900258.5

0900260.9

0900261.1

1400275.8

1400276.0M001

1400276.0M002

1400276.0M003

1400276.0M004

1400276.0M005

1400277.2M001

1400277.2M002

1400278.4

28-08-2019

0410349.5M001

0410349.5M002

0410349.5M003

0410349.5M004

1400306.5M001

1400306.5M002

1400306.5M003

1400306.5M004

1400306.5M005

1400306.5M006

1400307.7M001

1400307.7M002

1400307.7M003

1400307.7M004

1400307.7M005

1400308.9

26-08-2019

0900262.3

0900263.5

0900264.7

0900265.0

0900267.4

1400288.5

1400289.7

29-08-2019

1400309.1



香港特別行政區政府知識產權署外觀設計註冊處

The Government of the Hong Kong Special Administrative Region

Designs Registry, Intellectual Property Department

根據註冊外觀設計條例第**67**及**76**條，更正註冊紀錄冊內及已提交文件中的錯誤 **Correction of Errors in Register and in Filed Documents under sections 67 and 76 of the Registered Designs Ordinance**

任何人士現可對下列更正錯誤的請求提出反對

Requests for correction of errors now open to opposition

如任何人士意欲反對下列請求，則須在本官方公報刊登是項更正請求的日期起計的兩個月內，根據註冊外觀設計規則第51(3)及62(4)條，採用指明外觀設計表格第D9號提交反對通知。如在限期內沒有收到任何反對通知，處長將依本公報刊登的更正請求的內容，准許是項更正請求。

If any person wishes to oppose the following requests, he shall file a notice of opposition in specified Designs Form D9 within two months from the date of advertisement in this official journal under sections 51(3) and 62(4) of the Registered Designs Rules. If no notice of opposition is received, the requests for correction will be allowed by the Registrar in the present advertised form.

請求更正外觀設計的表述的錯誤

Requests made for correction of the representations of the design

[11] 1801625.7M001

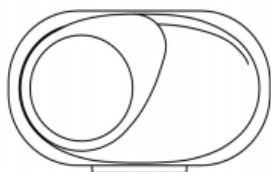

Top Plane View

[11] 1801625.7M002

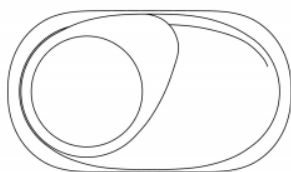

Top Plane View



香港特別行政區政府知識產權署外觀設計註冊處

The Government of the Hong Kong Special Administrative Region

Designs Registry, Intellectual Property Department

根據註冊外觀設計條例第 76 條，更正已提交文件中的錯誤

Correction of errors in filed documents under section 76 of the Registered Designs Ordinance

任何人士現可對下列更正錯誤的請求提出反對

Requests for correction of errors now open to opposition

如任何人士意欲反對下列請求，則須在本官方公報刊登是項更正請求的日期起計的兩個月內，根據註冊外觀設計規則第 51(3) 及 62(4) 條，採用指明外觀設計表格第 D9 號提交反對通知。如在限期內沒有收到任何反對通知，處長將依本公報刊登的更正請求的內容，准許是項更正請求。

If any person wishes to oppose the following requests, he shall file a notice of opposition in specified Designs Form D9 within two months from the date of advertisement in this official journal under sections 51(3) and 62(4) of the Registered Designs Rules. If no notice of opposition is received, the requests for correction will be allowed by the Registrar in the present advertised form.

[11] 1801617.0M002

[17] 26-08-2019

[11] 1801617.0M001

[17] 26-08-2019