

香港知識產權公報

Hong Kong Intellectual Property Journal

2020年11月13日
13 November 2020

目錄 Contents

根據註冊外觀設計條例第 25 條註冊的外觀設計

Designs Registered under section 25 of the Registered Designs Ordinance

按註冊編號排列

Arranged by Registration Number

根據註冊外觀設計條例(第 522 章)公布的其他公告

Other Notices Published under the Registered Designs Ordinance (Cap. 522)

根據註冊外觀設計條例第 28 條，註冊外觀設計因未繳續期費而停止有效

Registered designs ceased through non-payment of renewal fees under section 28 of the Registered Designs Ordinance

根據註冊外觀設計規則第 31 條刪除的註冊外觀設計

Registered designs removed under section 31 of the Registered Designs Rules

以下事項沒有記錄

No Records for the Following Matters

根據註冊外觀設計條例第 30 條放棄的外觀設計的註冊

Surrender of Registration of Design under section 30 of the Registered Designs Ordinance

根據註冊外觀設計規則第 37 條，向處長作出轉介

Reference to Registrar under section 37 of the Registered Designs Rules

根據註冊外觀設計條例第 45 條，撤銷註冊

Revocation of Registration under section 45 of the Registered Designs Ordinance

根據註冊外觀設計規則第 46 條，向法院作出轉介

Reference to Court under section 46 of the Registered Designs Rules

根據註冊外觀設計規則第 63 條對不符合規定之處作出糾正

Rectification of Irregularities under section 63 of the Registered Designs Rules

根據註冊外觀設計條例第 66 條，糾正註冊紀錄冊

Rectification of Register under section 66 of the Registered Designs Ordinance

根據註冊外觀設計條例第 67 條 更正註冊紀錄冊內的錯誤

Correction of errors in Register under section 67 of the Registered Designs Ordinance

根據註冊外觀設計條例第 67 及 76 條，更正註冊紀錄冊內及已提交文件中的錯誤

Correction of Errors in Register and in Filed Documents under sections 67 and 76 of the Registered Designs Ordinance

根據註冊外觀設計條例第 76 條，更正已提交文件中的錯誤

Correction of errors in filed documents under section 76 of the Registered Designs Ordinance

勘誤

Corrigendum

註冊外觀設計公告註釋

Notes on advertisements of registration of designs

方括號表示下列資料：

Square brackets indicate the following data：

[11] 註冊編號 Registration number / 聯合王國註冊編號 United Kingdom registration number

[15] 註冊日期 Registration date / 當作註冊日期 Deemed registration date / 聯合王國註冊日期 United Kingdom registration date

[17] 註冊有效期屆滿日期 Expiry date of the period of registration

[22] 提交日期 Filing date / 當作提交日期 Deemed filing date / 聯合王國提交日期 United Kingdom filing date

[30] 聲稱享有的優先權（提交日期 / 巴黎公約國或世界貿易組織成員 / 申請編號） Priority claimed (filing date / Paris Convention country or WTO member / application number)

[51] 國際外觀設計分類號（洛迦諾分類號） International Classification of designs (Locarno Classification)

[54] 物品 Article

[55] 外觀設計的表述 Representation of the design

[62] 分開前的申請編號及提交日期 Application number before division and filing date

[66] 過往註冊的聯繫外觀設計註冊編號 / 日期 Registration No. / Date of Previous Registration for Association

[72] 設計人 Designer

[73] 擁有人姓名和地址 Name and address of the owner

[74] 代理人 Agent / 送達地址 Address for service



香港特別行政區政府知識產權署外觀設計註冊處

The Government of the Hong Kong Special Administrative Region

Designs Registry, Intellectual Property Department

根據註冊外觀設計條例第 25 條註冊的外觀設計

Designs registered under section 25 of the Registered Designs Ordinance

按註冊編號排列

Arranged by Registration Number

[11] 1700056.7

[15] 16-01-2017

[51] Cl. 4-02

[54] 牙縫刷

Interdental brush

[73] Guangzhou T.K Medical Instrument Co., Ltd.

A601 Guangzhou International Business Incubator,

Guangzhou Science Park,

510663 Guangzhou, CHINA

[74] MARKS & CLERK

Level 9, Cyberport 1

100 Cyberport Road, Pok Fu Lam

HONG KONG



[11] 1914721.6M001

[15] 25-09-2019

[30] 26-03-2019 / EU / 006329439

[51] Cl. 14-03

[54] 遙控器

Remote control

[73] BANG & OLUFSEN A/S
Peter Bangs Vej 15,
7600 Struer,
DENMARK

[74] HOGAN LOVELLS
11th Floor, One Pacific Place
88 Queensway
HONG KONG



[11] 1914721.6M002

[15] 25-09-2019

[30] 26-03-2019 / EU / 006329439

[51] Cl. 14-03

[54] 遙控器

Remote control

[73] BANG & OLUFSEN A/S
Peter Bangs Vej 15,
7600 Struer,
DENMARK

[74] HOGAN LOVELLS
11th Floor, One Pacific Place
88 Queensway
HONG KONG

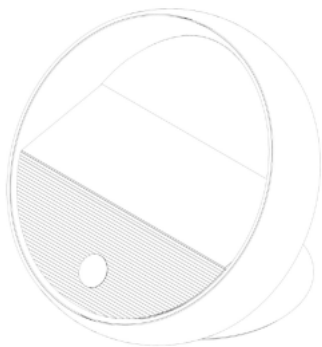

[11] 2015788.1M001

[15] 16-03-2020

[51] Cl. 10-02

[54] 手錶

Watch

[73] 尹樹源

Wun Shu Yuen Kenny

香港荃灣

沙咀道 29-35 號

科技中心 5 樓 10 室

[74] Wun Shu Yuen Kenny

香港荃灣

沙咀道 29-35 號

科技中心 5 樓 10 室



[11] 2015788.1M002

[15] 16-03-2020

[51] Cl. 10-02

[54] 手錶

Watch

[73] 尹樹源

Wun Shu Yuen Kenny

香港荃灣

沙咀道 29-35 號

科技中心 5 樓 10 室

[74] Wun Shu Yuen Kenny

香港荃灣

沙咀道 29-35 號
科技中心 5 樓 10 室



[11] 2015788.1M003

[15] 16-03-2020

[51] Cl. 10-02

[54] 手錶

Watch

[73] 尹樹源

Wun Shu Yuen Kenny

香港荃灣

沙咀道 29-35 號

科技中心 5 樓 10 室

[74] Wun Shu Yuen Kenny

香港荃灣

沙咀道 29-35 號

科技中心 5 樓 10 室



[11] 2015788.1M004

[15] 16-03-2020

[51] Cl. 10-02

[54] 手錶

Watch

[73] 尹樹源

Wun Shu Yuen Kenny

香港荃灣

沙咀道 29-35 號

科技中心 5 樓 10 室

[74] Wun Shu Yuen Kenny

香港荃灣

沙咀道 29-35 號

科技中心 5 樓 10 室



[11] 2015790.5M001

[15] 16-03-2020

[51] Cl. 10-02

[54] 手錶

Watch

[73] 尹樹源

Wun Shu Yuen Kenny

香港荃灣

沙咀道 29-35 號

科技中心 5 樓 10 室

[74] Wun Shu Yuen Kenny

香港荃灣

沙咀道 29-35 號

科技中心 5 樓 10 室



[11] 2015790.5M002

[15] 16-03-2020

[51] Cl. 10-02

[54] 手錶

Watch

[73] 尹樹源

Wun Shu Yuen Kenny

香港荃灣

沙咀道 29-35 號

科技中心 5 樓 10 室

[74] Wun Shu Yuen Kenny

香港荃灣

沙咀道 29-35 號
科技中心 5 樓 10 室



[11] 2015790.5M003

[15] 16-03-2020

[51] Cl. 10-02

[54] 手錶

Watch

[73] 尹樹源

Wun Shu Yuen Kenny

香港荃灣

沙咀道 29-35 號

科技中心 5 樓 10 室

[74] Wun Shu Yuen Kenny

香港荃灣

沙咀道 29-35 號

科技中心 5 樓 10 室



[11] 2015790.5M004

[15] 16-03-2020

[51] Cl. 10-02

[54] 手錶

Watch

[73] 尹樹源

Wun Shu Yuen Kenny

香港荃灣

沙咀道 29-35 號

科技中心 5 樓 10 室

[74] Wun Shu Yuen Kenny

香港荃灣

沙咀道 29-35 號

科技中心 5 樓 10 室



[11] 2015790.5M005

[15] 16-03-2020

[51] Cl. 10-02

[54] 手錶

Watch

[73] 尹樹源

Wun Shu Yuen Kenny

香港荃灣

沙咀道 29-35 號

科技中心 5 樓 10 室

[74] Wun Shu Yuen Kenny

香港荃灣

沙咀道 29-35 號

科技中心 5 樓 10 室



[11] 2015790.5M006

[15] 16-03-2020

[51] Cl. 10-02

[54] 手錶

Watch

[73] 尹樹源

Wun Shu Yuen Kenny

香港荃灣

沙咀道 29-35 號

科技中心 5 樓 10 室

[74] Wun Shu Yuen Kenny

香港荃灣

沙咀道 29-35 號
科技中心 5 樓 10 室



[11] 2015923.8

[15] 06-04-2020

[51] Cl. 29-02

[54] 一次性面罩
Disposable faceshield

[73] 彭嘉欣
Pang Ka Yan
Units 308-309, 15W,
Hong Kong Science Park,
NT, Hong Kong

[74] ACCOLADE IP LIMITED
10/F, Fu Fai Comm. Ctr.,
27 Hillier Street,
Sheung Wan, Hong Kong

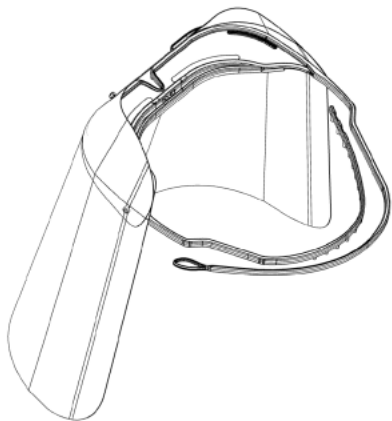

[11] 2016006.5M001

[15] 17-04-2020

[30] 17-10-2019 / EU / 007039631

[51] Cl. 13-02

[54] 用於氣霧產生裝置的充電器

Charger for aerosol generating device

[73] Philip Morris Products S.A.

Quai Jeanrenaud 3,

CH-2000 Neuchâtel,

SWITZERLAND

[74] CLT PATENT & TRADEMARK (H.K.) LIMITED

Unit 09, 34/F., Office Tower, Convention Plaza,

No. 1 Harbour Road,

Wanchai, Hong Kong

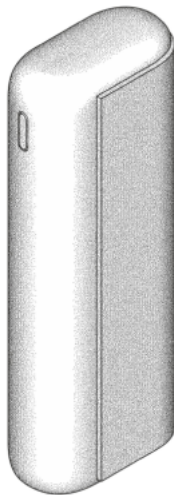

[11] 2016006.5M002

[15] 17-04-2020

[30] 17-10-2019 / EU / 007039631

[51] Cl. 13-02

[54] 用於氣霧產生裝置的充電器

Charger for aerosol generating device

[73] Philip Morris Products S.A.

Quai Jeanrenaud 3,

CH-2000 Neuchâtel,

SWITZERLAND

[74] CLT PATENT & TRADEMARK (H.K.) LIMITED

Unit 09, 34/F., Office Tower, Convention Plaza,

No. 1 Harbour Road,

Wanchai, Hong Kong

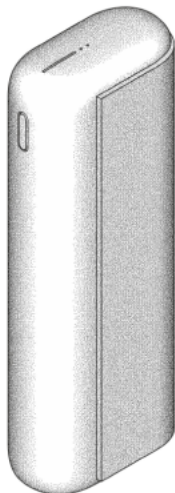

[11] 2016006.5M003

[15] 17-04-2020

[30] 17-10-2019 / EU / 007039631

[51] Cl. 13-02

[54] 用於氣霧產生裝置的充電器

Charger for aerosol generating device

[73] Philip Morris Products S.A.

Quai Jeanrenaud 3,

CH-2000 Neuchâtel,

SWITZERLAND

[74] CLT PATENT & TRADEMARK (H.K.) LIMITED

Unit 09, 34/F., Office Tower, Convention Plaza,

No. 1 Harbour Road,

Wanchai, Hong Kong

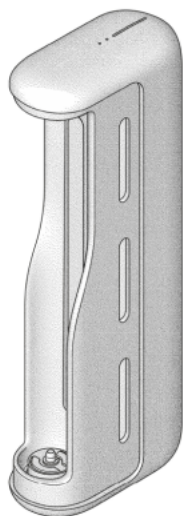

[11] 2016006.5M004

[15] 17-04-2020

[30] 17-10-2019 / EU / 007039631

[51] Cl. 13-02

[54] 用於氣霧產生裝置的充電器的部分

Part of Charger for aerosol generating device

[73] Philip Morris Products S.A.

Quai Jeanrenaud 3,

CH-2000 Neuchâtel,

SWITZERLAND

[74] CLT PATENT & TRADEMARK (H.K.) LIMITED

Unit 09, 34/F., Office Tower, Convention Plaza,

No. 1 Harbour Road,

Wanchai, Hong Kong

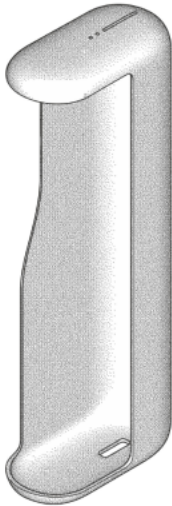

[11] 2016006.5M005

[15] 17-04-2020

[30] 17-10-2019 / EU / 007039631

[51] Cl. 13-02

[54] 用於氣霧產生裝置的充電器的部分

Part of charger for aerosol generating device

[73] Philip Morris Products S.A.

Quai Jeanrenaud 3,

CH-2000 Neuchâtel,

SWITZERLAND

[74] CLT PATENT & TRADEMARK (H.K.) LIMITED

Unit 09, 34/F., Office Tower, Convention Plaza,

No. 1 Harbour Road,

Wanchai, Hong Kong

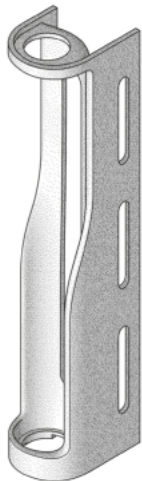

[11] 2016006.5M006

[15] 17-04-2020

[30] 17-10-2019 / EU / 007039631

[51] Cl. 13-02

[54] 用於氣霧產生裝置的充電器的部分

Part of charger for aerosol generating device

[73] Philip Morris Products S.A.

Quai Jeanrenaud 3,

CH-2000 Neuchâtel,

SWITZERLAND

[74] CLT PATENT & TRADEMARK (H.K.) LIMITED

Unit 09, 34/F., Office Tower, Convention Plaza,

No. 1 Harbour Road,

Wanchai, Hong Kong

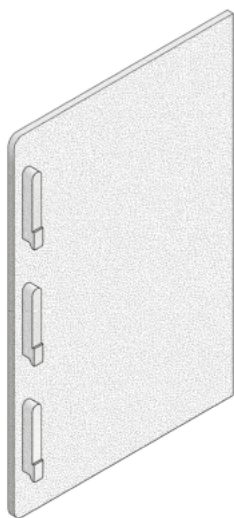

- [11] 2016006.5M007
[15] 17-04-2020
[30] 17-10-2019 / EU / 007039631
[51] Cl. 13-02
[54] 用於氣霧產生裝置的充電器的部分
Part of charger for aerosol generating device
[73] Philip Morris Products S.A.
Quai Jeanrenaud 3,
CH-2000 Neuchâtel,
SWITZERLAND
[74] CLT PATENT & TRADEMARK (H.K.) LIMITED
Unit 09, 34/F., Office Tower, Convention Plaza,
No. 1 Harbour Road,
Wanchai, Hong Kong

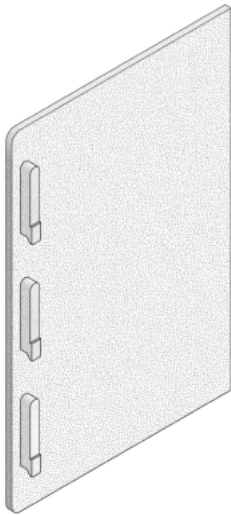

-
- [11] 2016086.3
[15] 29-04-2020
[30] 20-11-2019 / KR / 30-2019-0055517
[51] Cl. 28-03
[54] 紋身器具控制器
A controller for a tattooing apparatus
[73] 寶泰電子有限公司
BOMTECH ELECTRONICS Co., Ltd.
322, Gonghang-daero,
Gangseo-gu, Seoul,
Korea, Republic of
[74] BENNY KONG & TSAI
Unit 19B, Overseas Trust Bank Building,
No. 160 Gloucester Road,
Wanchai, Hong Kong

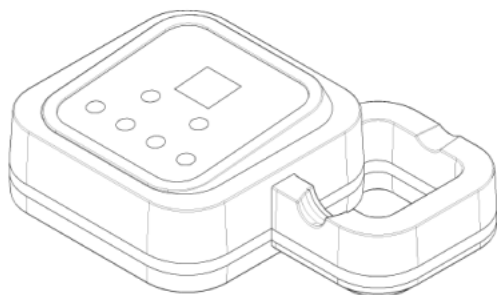

[11] 2016128.3

[15] 11-05-2020

[30] 11-11-2019 / US / 29/712,700

[51] Cl. 28-03

[54] 化妝品施用器

Cosmetic applicator

[73] ELC MANAGEMENT LLC

155 Pinelawn Road, Suite 345 South,
Melville, NY 11747,
United States

[74] CHINA PATENT AGENT (HONG KONG) LIMITED

22/F, Great Eagle Centre,
23 Harbour Road,
Wanchai, Hong Kong



[11] 2016143.4

[15] 14-05-2020

[30] 14-11-2019 / US / 29/713,288

[51] Cl. 27-07

[54] 蒸發裝置

Vaporizer device

[73] JUUL Labs, Inc.

560 20th Street, Building 104,

San Francisco, CA 94107,

United States

[74] HNC INNOVATION LIMITED

Units 1205-1208, Cyberport 2,

No. 100 Cyberport Road,

Hong Kong

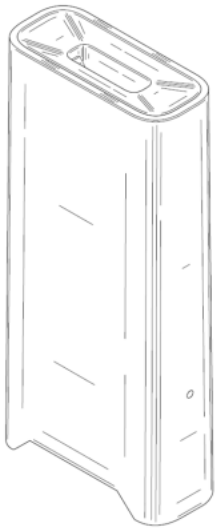

[11] 2016144.6

[15] 14-05-2020

[30] 14-11-2019 / US / 29/713,290

[51] Cl. 27-07

[54] 蒸發裝置

Vaporizer device

[73] JUUL Labs, Inc.

560 20th Street, Building 104,

San Francisco, CA 94107,

United States

[74] HNC INNOVATION LIMITED

Units 1205-1208, Cyberport 2,

No. 100 Cyberport Road,

Hong Kong



[11] 2016145.9

[15] 14-05-2020

[30] 14-11-2019 / US / 29/713,291

[51] Cl. 27-07

[54] 蒸發裝置

Vaporizer device

[73] JUUL Labs, Inc.

560 20th Street, Building 104,

San Francisco, CA 94107,

United States

[74] HNC INNOVATION LIMITED

Units 1205-1208, Cyberport 2,

No. 100 Cyberport Road,

Hong Kong

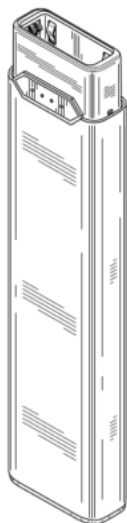

- [11] 2016151.1
[15] 15-05-2020
[30] 05-12-2019 / EU / 007342217-0003
[51] Cl. 21-01
[54] 玩具齒條傳動輪
Toy rack gear
[73] Chiswick Innovations Limited
7 Chesterfield Road, London, Greater London,
MIDDX W4 3HG,
United Kingdom
[74] UNITALEN ATTORNEYS AT LAW LIMITED
Rm 1201, 12/F, Golden Era Plaza,
39-55 Sai Yee St,
Mongkok. Kln, Hong Kong

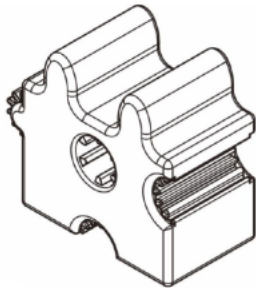

-
- [11] 2016166.3
[15] 19-05-2020
[51] Cl. 14-04
[54] 用於電子裝置顯示屏的圖標或動態圖標
Icon or animated icon for display screen of an electronic
device
[73] 蘭博基尼汽車股份有限公司
AUTOMOBILI LAMBORGHINI S.P.A.
Via Modena 12, 40019 Sant'agata,
Bolognese (Bologna),
Italy
[74] SHANGHAI INTELLECTUAL PROPERTY OFFICE
Unit F, 20th Floor, Neich Tower,
128 Gloucester Road,
Hong Kong

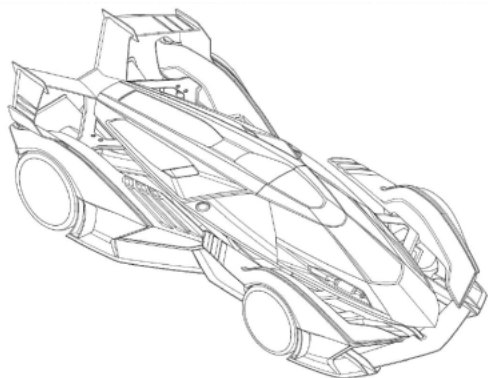

[11] 2016200.6M001

[15] 22-05-2020

[30] 22-11-2019 / US / 29/714,474

[51] Cl. 14-03

Cl. 14-02

Cl. 14-01

[54] 電子裝置

Electronic device

[73] 蘋果公司

APPLE INC.

One Apple Park Way, Cupertino,

California 95014,

United States

[74] CLT PATENT & TRADEMARK (H.K.) LIMITED

Unit 09, 34/F., Office Tower, Convention Plaza,

No. 1 Harbour Road,

Wanchai, Hong Kong

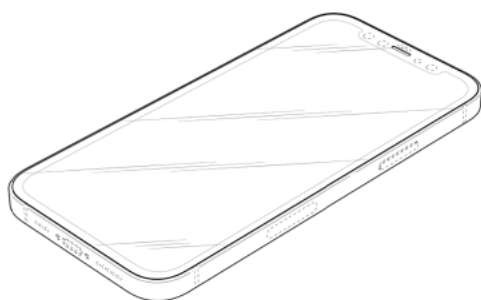

[11] 2016200.6M002

[15] 22-05-2020

[30] 22-11-2019 / US / 29/714,474

[51] Cl. 14-03
Cl. 14-02
Cl. 14-01

[54] 電子裝置
Electronic device

[73] 蘋果公司
APPLE INC.
One Apple Park Way, Cupertino,
California 95014,
United States

[74] CLT PATENT & TRADEMARK (H.K.) LIMITED
Unit 09, 34/F., Office Tower, Convention Plaza,
No. 1 Harbour Road,
Wanchai, Hong Kong

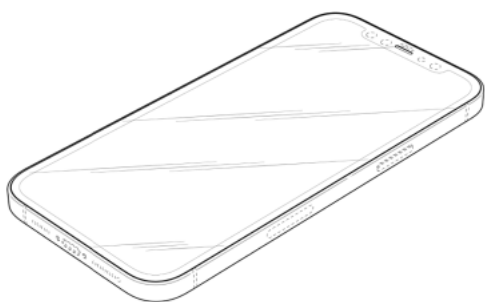

[11] 2016200.6M003

[15] 22-05-2020

[30] 22-11-2019 / US / 29/714,474

[51] Cl. 14-03
Cl. 14-02
Cl. 14-01

[54] 電子裝置
Electronic device

[73] 蘋果公司
APPLE INC.
One Apple Park Way, Cupertino,
California 95014,
United States

[74] CLT PATENT & TRADEMARK (H.K.) LIMITED
Unit 09, 34/F., Office Tower, Convention Plaza,

No. 1 Harbour Road,
Wanchai, Hong Kong



[11] 2016200.6M004

[15] 22-05-2020

[30] 22-11-2019 / US / 29/714,474

[51] Cl. 14-03

Cl. 14-02

Cl. 14-01

[54] 電子裝置

Electronic device

[73] 蘋果公司

APPLE INC.

One Apple Park Way, Cupertino,

California 95014,

United States

[74] CLT PATENT & TRADEMARK (H.K.) LIMITED

Unit 09, 34/F., Office Tower, Convention Plaza,

No. 1 Harbour Road,

Wanchai, Hong Kong



[11] 2016200.6M005

[15] 22-05-2020

[30] 22-11-2019 / US / 29/714,474

[51] Cl. 14-03

Cl. 14-02

Cl. 14-01

[54] 電子裝置

Electronic device

[73] 蘋果公司

APPLE INC.

One Apple Park Way, Cupertino,

California 95014,

United States

[74] CLT PATENT & TRADEMARK (H.K.) LIMITED

Unit 09, 34/F., Office Tower, Convention Plaza,

No. 1 Harbour Road,

Wanchai, Hong Kong

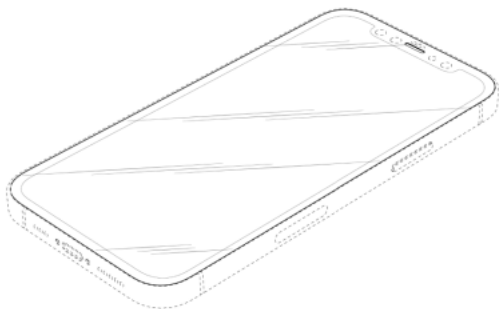

[11] 2016200.6M006

[15] 22-05-2020

[30] 22-11-2019 / US / 29/714,474

[51] Cl. 14-03

Cl. 14-02

Cl. 14-01

[54] 電子裝置

Electronic device

[73] 蘋果公司

APPLE INC.

One Apple Park Way, Cupertino,

California 95014,

United States

[74] CLT PATENT & TRADEMARK (H.K.) LIMITED

Unit 09, 34/F., Office Tower, Convention Plaza,

No. 1 Harbour Road,

Wanchai, Hong Kong

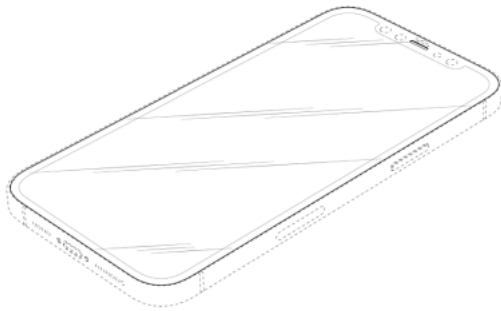

[11] 2016200.6M007

[15] 22-05-2020

[30] 22-11-2019 / US / 29/714,474

[51] Cl. 14-03

Cl. 14-02

Cl. 14-01

[54] 電子裝置

Electronic device

[73] 蘋果公司

APPLE INC.

One Apple Park Way, Cupertino,

California 95014,

United States

[74] CLT PATENT & TRADEMARK (H.K.) LIMITED

Unit 09, 34/F., Office Tower, Convention Plaza,

No. 1 Harbour Road,

Wanchai, Hong Kong

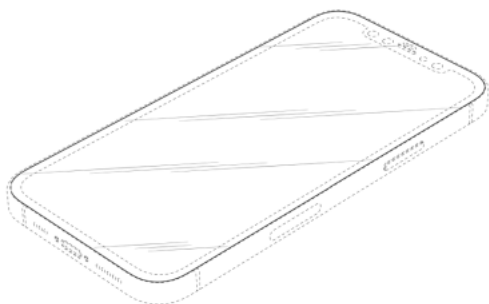

[11] 2016200.6M008

[15] 22-05-2020

[30] 22-11-2019 / US / 29/714,474

[51] Cl. 14-03

Cl. 14-02

Cl. 14-01

[54] 電子裝置

Electronic device

[73] 蘋果公司

APPLE INC.

One Apple Park Way, Cupertino,

California 95014,

United States

[74] CLT PATENT & TRADEMARK (H.K.) LIMITED

Unit 09, 34/F., Office Tower, Convention Plaza,

No. 1 Harbour Road,

Wanchai, Hong Kong

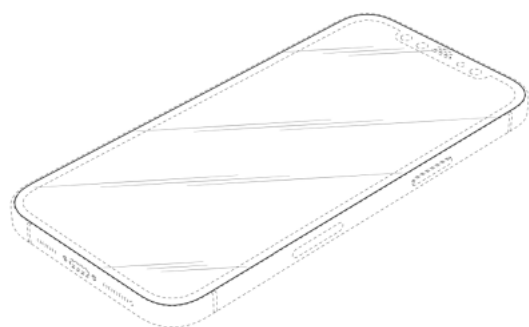

- [11] 2016270.3
[15] 04-06-2020
[51] Cl. 14-99
[54] 七合一多功能充電傳輸轉換器
7 in 1 multifunction charging transmission converter
[73] DESIGN POOL LIMITED (Attention : Legal Officer)
2/F, East Town Building,
41 Lockhart Road,
Wanchai, Hong Kong
[74] DESIGN POOL LIMITED (Attention : Legal Officer)
2/F, East Town Building,
41 Lockhart Road,
Wanchai, Hong Kong

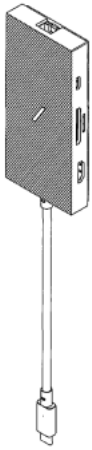

-
- [11] 2016314.7
[15] 10-06-2020
[51] Cl. 5-06
Cl. 5-05
[54] 用於皮革、人造皮革、紡織材料、塑料、金屬或其他材料的圖案設計
Pattern design for leather, imitation leather, textile,
plastic, metal or other materials
[73] 麗連有限公司
LA LINS COMPANY LIMITED
4th Floor, Block B,
Chuan Yuan Factory Building,
342-344 Kwun Tong Road,
Kwun Tong, Kowloon, Hong Kong
[74] VINCENT LUK & ASSOCIATES
Unit A, 13th Floor,
Nathan Commercial Building,

430 Nathan Road,
Kowloon, Hong Kong

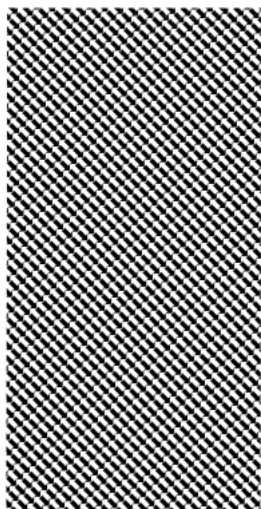

[11] 2016475.8

[15] 13-07-2020

[30] 20-02-2020 / DE / 40 2020 100 170.8

[51] Cl. 21-01

[54] 玩具汽車

Toy vehicle

[73] VOLKSWAGEN AKTIENGESELLSCHAFT

Berliner Ring 2,

38440 Wolfsburg,

Germany

[74] CHINA PATENT AGENT (HONG KONG) LIMITED

22/F, Great Eagle Centre,

23 Harbour Road,

Wanchai, Hong Kong



[11] 2016493.5M001

[15] 14-07-2020

[30] 20-02-2020 / DE / 40 2020 100 171.6

[51] Cl. 12-08

[54] 汽車

Motor vehicle

[73] VOLKSWAGEN AKTIENGESELLSCHAFT

Berliner Ring 2,

38440 Wolfsburg,

Germany

[74] CHINA PATENT AGENT (HONG KONG) LIMITED

22/F, Great Eagle Centre,

23 Harbour Road,

Wanchai, Hong Kong



[11] 2016493.5M002

[15] 14-07-2020

[30] 20-02-2020 / DE / 40 2020 100 171.6

[51] Cl. 12-08

[54] 汽車

Motor vehicle

[73] VOLKSWAGEN AKTIENGESELLSCHAFT

Berliner Ring 2,

38440 Wolfsburg,

Germany

[74] CHINA PATENT AGENT (HONG KONG) LIMITED

22/F, Great Eagle Centre,

23 Harbour Road,

Wanchai, Hong Kong



[11] 2016493.5M003

[15] 14-07-2020

[30] 20-02-2020 / DE / 40 2020 100 171.6

[51] Cl. 12-08

[54] 汽車

Motor vehicle

[73] VOLKSWAGEN AKTIENGESELLSCHAFT

Berliner Ring 2,

38440 Wolfsburg,

Germany

[74] CHINA PATENT AGENT (HONG KONG) LIMITED

22/F, Great Eagle Centre,

23 Harbour Road,

Wanchai, Hong Kong



[11] 2016544.5M001

[15] 21-07-2020

[51] Cl. 3-01

[54] 錢包、卡片套、零錢包或鑰匙包

Wallet, card holder, coins bag or key bag

[73] 華緻貿易有限公司

Motto Carpe Diem Limited

香港新蒲崗

五芳街 19-21 號

嘉榮工廠大廈 1 樓 C 室

[74] Motto Carpe Diem Limited

香港新蒲崗

五芳街 19-21 號

嘉榮工廠大廈 1 樓 C 室



[11] 2016544.5M002

[15] 17-08-2020

[51] Cl. 3-01

[54] 錢包、卡片套、零錢包或鑰匙包

Wallet, card holder, coins bag or key bag

[73] 華緻貿易有限公司

Motto Carpe Diem Limited

香港新蒲崗

五芳街 19-21 號

嘉榮工廠大廈 1 樓 C 室

[74] Motto Carpe Diem Limited

香港新蒲崗

五芳街 19-21 號

嘉榮工廠大廈 1 樓 C 室



- [11] 2016550.8
[15] 22-07-2020
[51] Cl. 12-07
[54] 陀螺儀無人飛行器
Gyrotrak unmanned aerial vehicle
[73] ROTOJET HUNGARY KFT.
6035 Balloszog,
62/12 Hrsz.
Hungary
[74] UNITALEN ATTORNEYS AT LAW LIMITED
Rm 1201, 12/F, Golden Era Plaza,
39-55 Sai Yee St,
Mongkok. Kowloon, Hong Kong

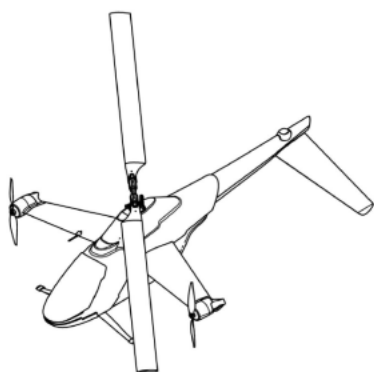

-
- [11] 2016570.0
[15] 27-07-2020
[30] 27-01-2020 / US / 29/722,198
[51] Cl. 3-01
[54] 耳塞式耳機收納盒
Earbud headset case
[73] Skullcandy, Inc.
6301 N. Landmark Dr. Park City, UT 84098,
United States
[74] CLT PATENT & TRADEMARK (H.K.) LIMITED
Unit 09, 34/F., Office Tower, Convention Plaza,
No. 1 Harbour Road,
Wanchai, Hong Kong



[11] 2016571.2M001

[15] 28-07-2020

[30] 29-01-2020 / EU / 007567938-0001

[51] Cl. 21-01

[54] 玩具

Toy

[73] LEGO A/S

Aastvej 1,
7190 Billund,
Denmark

[74] WILKINSON & GRIST

6th Floor, Prince's Building,
Chater Road,
Hong Kong

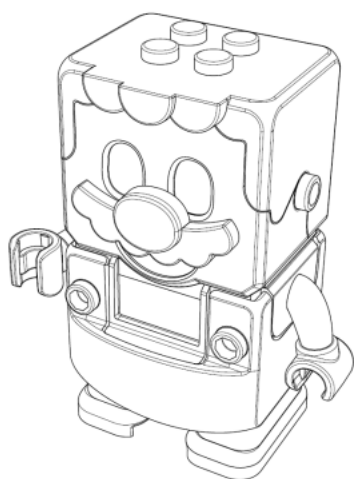

[11] 2016571.2M002

- [15] 28-07-2020
[30] 29-01-2020 / EU / 007567938-0002
[51] Cl. 21-01
[54] 玩具
Toy
[73] LEGO A/S
Aastvej 1,
7190 Billund,
Denmark
[74] WILKINSON & GRIST
6th Floor, Prince's Building,
Chater Road,
Hong Kong

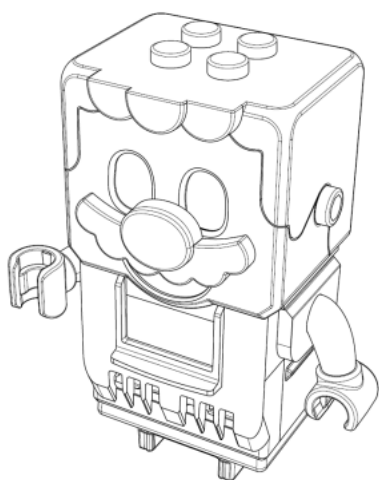

-
- [11] 2016571.2M003
[15] 28-07-2020
[30] 29-01-2020 / EU / 007567938-0003
[51] Cl. 21-01
[54] 玩具
Toy
[73] LEGO A/S
Aastvej 1,
7190 Billund,
Denmark
[74] WILKINSON & GRIST
6th Floor, Prince's Building,
Chater Road,
Hong Kong

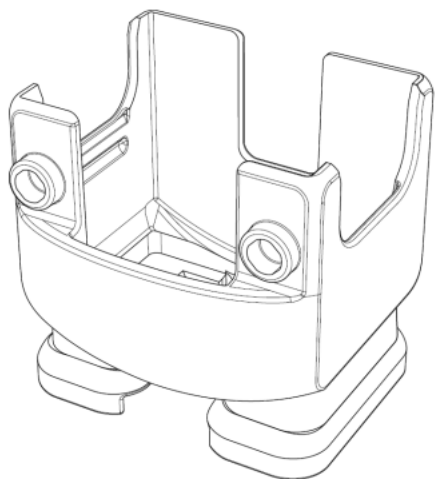

[11] 2016572.4

[15] 28-07-2020

[30] 03-03-2020 / WO / DM/207 843

[51] Cl. 3-01

[54] 袋
Bag

[73] CHANEL
135 avenue Charles de Gaulle,
92200 Neuilly-sur-Seine,
France

[74] WILKINSON & GRIST
6th Floor, Prince's Building,
Chater Road,
Hong Kong





香港特別行政區政府知識產權署外觀設計註冊處

The Government of the Hong Kong Special Administrative Region

Designs Registry, Intellectual Property Department

根據註冊外觀設計條例第 28 條，下列註冊外觀設計因未繳續期費而停止有效。

各組記項按註冊外觀設計停止有效日期及註冊編號先後次序排列。

Registered designs ceased through non-payment of renewal fees under section 28 of the Registered Designs Ordinance. Entries are listed below under their expiry dates.

03-09-2020 - 09-09-2020

03-09-2020

1501953.8

1501954.0

1501957.7M001

1501957.7M002

1501985.6

1501986.8

1501989.4

05-09-2020

1001607.1M003

08-09-2020

0502094.4

0502095.7M001

0502095.7M002

1001626.1M001

1001626.1M002

1001626.1M003

1001626.1M004

1001626.1M005

1001628.5M001

1001628.5M002

1001628.5M003

1001628.5M004

1501994.4

1501995.7M001

1501995.7M002

1502006.2

1502010.0

06-09-2020

0011223.5

0502067.8

1001609.5

1001615.8M001

1001615.8M002

1001616.0

1501963.9

1501965.4

1501966.6

1501968.0

1501969.2

1501970.4

1501971.6

1501972.8

1501973.0

07-09-2020

0502079.3

0502081.7

1501667.2

1501668.4

1501669.6

1501670.8

1501984.3

09-09-2020

1001632.3

1001640.0M001

1001640.0M002

1001640.0M003

1001640.0M004

1502014.8

1502015.1M001

1502015.1M002



香港特別行政區政府知識產權署外觀設計註冊處

The Government of the Hong Kong Special Administrative Region

Designs Registry, Intellectual Property Department

根據註冊外觀設計規則第 31 條刪除的註冊外觀設計。各組記項按註冊外觀設計刪除日期及註冊編號先後次序排列。

Registered designs removed under section 31 of the Registered Designs Rules. Entries are listed below under their removal dates.

23-10-2020 - 29-10-2020

23-10-2020	0500447.2	1500324.3
1000316.2		1500325.6
1000393.3	27-10-2020	1500326.8
1000400.0	0500458.5	1500327.0
1000402.4M003		1500328.2
1000402.4M004	28-10-2020	1500329.4
1000402.4M007	0500474.8	
1500578.2	0500477.5	
1500580.6	1000419.0M001	
	1000419.0M002	
24-10-2020	1000421.4M001	
1000406.3	1000421.4M002	
1000407.5	1000421.4M003	
1500583.2	1000421.4M004	
1500584.4	1500603.6M001	
1500585.7	1500605.1	
1500586.9	1500620.2M001	
1500594.5M001	1500620.2M002	
1500594.5M002	1500620.2M003	
1500595.8M001	1500620.2M004	
1500595.8M002	1500621.4M001	
	1500621.4M002	
25-10-2020	1500621.4M003	
1500581.8	1500621.4M004	
1500596.0M003	1500621.4M005	
1500596.0M004	1500621.4M006	
1500596.0M005	1500621.4M007	
1500597.2		
1500598.4	29-10-2020	
1500599.6	0500488.8	
1500600.0	0500489.0	
1500601.2	0500492.6	
	0500494.0	
26-10-2020	1000428.9M002	