

# 香港知識產權公報

Hong Kong Intellectual Property Journal

2019年12月13日

13 December 2019



## 目錄 Contents

### 根據註冊外觀設計條例第 25 條註冊的外觀設計

#### **Designs Registered under section 25 of the Registered Designs Ordinance**

按註冊編號排列

Arranged by Registration Number

### 根據註冊外觀設計條例(第 522 章)公布的其他公告

#### **Other Notices Published under the Registered Designs Ordinance (Cap. 522)**

根據註冊外觀設計條例第 28 條, 註冊外觀設計因未繳續期費而停止有效

Registered designs ceased through non-payment of renewal fees under section 28 of the Registered Designs Ordinance

根據註冊外觀設計規則第 31 條刪除的註冊外觀設計

Registered designs removed under section 31 of the Registered Designs Rules

### 以下事項沒有記錄

#### **No Records for the Following Matters**

根據註冊外觀設計條例第 30 條放棄的外觀設計的註冊

Surrender of Registration of Design under section 30 of the Registered Designs Ordinance

根據註冊外觀設計規則第 37 條, 向處長作出轉介

Reference to Registrar under section 37 of the Registered Designs Rules

根據註冊外觀設計條例第 45 條, 撤銷註冊

Revocation of Registration under section 45 of the Registered Designs Ordinance

根據註冊外觀設計規則第 46 條，向法院作出轉介  
Reference to Court under section 46 of the Registered Designs Rules

根據註冊外觀設計規則第 63 條對不符合規定之處作出糾正  
Rectification of Irregularities under section 63 of the Registered Designs Rules

根據註冊外觀設計條例第 66 條，糾正註冊紀錄冊  
Rectification of Register under section 66 of the Registered Designs Ordinance

根據註冊外觀設計條例第 67 條，更正註冊紀錄冊內的錯誤  
Correction of Errors in Register under section 67 of the Registered Designs Ordinance

根據註冊外觀設計條例第 67 及 76 條，更正註冊紀錄冊內及已提交文件中的錯誤  
Correction of Errors in Register and in Filed Documents under sections  
67 and 76 of the Registered Designs Ordinance

根據註冊外觀設計條例第 76 條，更正已提交文件中的錯誤  
Correction of Errors in Filed Documents under section 76 of the Registered Designs  
Ordinance

勘誤  
Corrigendum

## 註冊外觀設計公告註釋

### Notes on advertisements of registration of designs

方括號表示下列資料：

Square brackets indicate the following data：

- [11] 註冊編號 Registration number / 聯合王國註冊編號 United Kingdom registration number
- [15] 註冊日期 Registration date / 當作註冊日期 Deemed registration date / 聯合王國註冊日期 United Kingdom registration date
- [17] 註冊有效期屆滿日期 Expiry date of the period of registration
- [22] 提交日期 Filing date / 當作提交日期 Deemed filing date / 聯合王國提交日期 United Kingdom filing date
- [30] 聲稱享有的優先權 (提交日期 / 巴黎公約國或世界貿易組織成員 / 申請編號) Priority claimed (filing date / Paris Convention country or WTO member / application number)
- [51] 國際外觀設計分類號 (洛迦諾分類號) International Classification of designs (Locarno Classification)
- [54] 物品 Article
- [55] 外觀設計的表述 Representation of the design
- [62] 分開前的申請編號及提交日期 Application number before division and filing date
- [66] 過往註冊的聯繫外觀設計註冊編號 / 日期 Registration No. / Date of Previous Registration for Association
- [72] 設計人 Designer

[73] 擁有人姓名和地址 Name and address of the owner

[74] 代理人 Agent / 送達地址 Address for service



香港特別行政區政府知識產權署外觀設計註冊處

The Government of the Hong Kong Special Administrative Region

Designs Registry, Intellectual Property Department

## 根據註冊外觀設計條例第25條註冊的外觀設計

### Designs registered under section 25 of the Registered Designs Ordinance

按註冊編號排列

Arranged by Registration Number

[11] 1802510.4

[15] 20-12-2018

[30] 20-06-2018 / FR / 2018-2992

[51] Cl. 2-04

[54] 鞋

Shoe

[73] LOUIS VUITTON MALLETIER

2, rue du Pont-Neuf 75001 Paris,  
FRANCE

[74] BAKER & MCKENZIE

14th Floor, One Taikoo Place  
979 King's Road, Quarry Bay  
HONG KONG



[11] 1802511.6

[15] 20-12-2018

[30] 20-06-2018 / FR / 2018-2992

[51] Cl. 2-04

[54] 鞋

Shoe

[73] LOUIS VUITTON MALLETIER  
2, rue du Pont-Neuf 75001 Paris,  
FRANCE

[74] BAKER & MCKENZIE  
14th Floor, One Taikoo Place  
979 King's Road, Quarry Bay  
HONG KONG

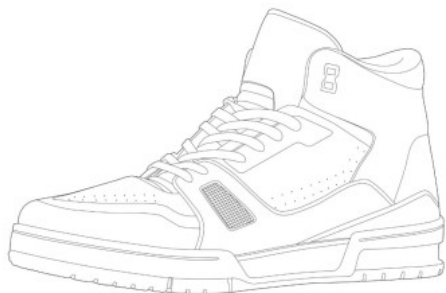

---

[11] 1802512.8

[15] 20-12-2018

[30] 20-06-2018 / FR / 2018-2992

[51] Cl. 2-04

[54] 鞋

Shoe

[73] LOUIS VUITTON MALLETIER  
2, rue du Pont-Neuf 75001 Paris,  
FRANCE

[74] BAKER & MCKENZIE  
14th Floor, One Taikoo Place  
979 King's Road, Quarry Bay  
HONG KONG



[11] 1900178.7

[15] 25-01-2019

[51] Cl. 25-01

[54] 盲導標示金屬配件

Metal accessory for tactile marker

[73] 加藍誘導標示有限公司

香港北角

英皇道 89 號

桂洪集團中心 2802 室

[74] 加藍誘導標示有限公司

香港北角

英皇道 89 號

桂洪集團中心 2802 室



[11] 1913131.3

[15] 05-03-2019

[51] Cl. 29-02

[54] 口罩之部分

A part of the mask

[73] 張德成

JONATHAN TEH CHENG CHANG

台灣 彰化縣彰化市彰南路

六段 424 巷 21 號

[74] 香港匯澤知識產權代理有限公司

香港

九龍尖沙咀廣東道 5 號

海港城海洋中心 8 樓 826 室





---

[11] 1913187.1

[15] 13-03-2019

[30] 26-12-2018 / CN / 201830758299.6

[51] Cl. 14-01

[54] 唱機的唱臂柱

Arm post for record player

[73] SONY CORPORATION

1-7-1 KONAN, MINATO-KU

TOKYO 108-0075

JAPAN

[74] UNITALEN ATTORNEYS AT LAW LIMITED

RM 1201, 12/F,

GOLDEN ERA PLAZA,

39-55 SAI YEE ST, MONGKOK KLN

HONG KONG

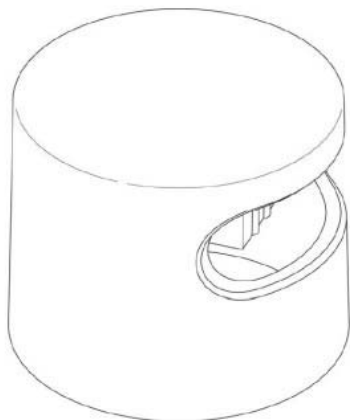

---

[11] 1913305.3M001

[15] 26-03-2019

[30] 28-09-2018 / IT / 402018000003120

[51] Cl. 3-01

[54] 袋

Bag

[73] VALENTINO S.p.A.  
Via Turati, 16/18  
I-20121 MILANO  
ITALY

[74] BARRON & YOUNG INTELLECTUAL PROPERTY LIMITED  
Suite 617, Lakeside 2  
No. 10 Science Park West Avenue, Hong Kong Science Park,  
Shatin, N.T.  
HONG KONG



---

[11] 1913305.3M002

[15] 26-03-2019

[30] 28-09-2018 / IT / 402018000003120

[51] Cl. 3-01

[54] 袋

Bag

[73] VALENTINO S.p.A.  
Via Turati, 16/18  
I-20121 MILANO  
ITALY

[74] BARRON & YOUNG INTELLECTUAL PROPERTY LIMITED  
Suite 617, Lakeside 2  
No. 10 Science Park West Avenue, Hong Kong Science Park,  
Shatin, N.T.  
HONG KONG



---

[11] 1913327.9

[15] 29-03-2019

[51] Cl. 24-99

[54] 助聽器

Hearing aid

[73] 力滔有限公司

LOGITAL CO. LIMITED

Rm 901 -902,9/F, Nathan Centre,  
580G-K Nathan Road, Mongkok, Kowloon,  
HONG KONG

[74] IPATENT AGENCY LIMITED

Rm 1008 Prosperity Millennia Plaza  
663 King's Road Quarry Bay  
HONG KONG



---

[11] 1913419.4M001

[15] 10-04-2019

[30] 11-10-2018 / CN / 201830567703.1

[51] Cl. 14-04

[54] 用於手機的圖形用戶界面

Graphical user interface for mobile phone

[73] 貝殼找房(北京)科技有限公司

Ke.com (Beijing) Technology Co., Ltd.

Room 102-1, Building No. 35

Courtyard No. 2, Xi'erqi West Road, Haidian District, Beijing  
CHINA

[74] BARRON & YOUNG INTELLECTUAL PROPERTY LIMITED

Suite 617, Lakeside 2

No. 10 Science Park West Avenue, Hong Kong Science Park,  
Shatin, N.T.

HONG KONG



---

[11] 1913419.4M002

[15] 10-04-2019

[30] 11-10-2018 / CN / 201830568198.2

[51] Cl. 14-04

[54] 用於手機的圖形用戶界面

Graphical user interface for mobile phone

[73] 貝殼找房(北京)科技有限公司

Ke.com (Beijing) Technology Co., Ltd.

Room 102-1, Building No. 35

Courtyard No. 2, Xi'erqi West Road, Haidian District, Beijing  
CHINA

[74] BARRON & YOUNG INTELLECTUAL PROPERTY LIMITED

Suite 617, Lakeside 2

No. 10 Science Park West Avenue, Hong Kong Science Park,

Shatin, N.T.  
HONG KONG



---

[11] 1913419.4M003

[15] 10-04-2019

[30] 11-10-2018 / CN / 201830568202.5

[51] Cl. 14-04

[54] 用於手機的圖形用戶界面

Graphical user interface for mobile phone

[73] 貝殼找房(北京)科技有限公司

Ke.com (Beijing) Technology Co., Ltd.

Room 102-1, Building No. 35

Courtyard No. 2, Xi'erqi West Road, Haidian District, Beijing

CHINA

[74] BARRON & YOUNG INTELLECTUAL PROPERTY LIMITED

Suite 617, Lakeside 2

No. 10 Science Park West Avenue, Hong Kong Science Park,

Shatin, N.T.

HONG KONG



[11] 1913419.4M004

[15] 10-04-2019

[30] 11-10-2018 / CN / 201830568202.5

[51] Cl. 14-04

[54] 用於手機的圖形用戶界面

Graphical user interface for mobile phone

[73] 貝殼找房(北京)科技有限公司

Ke.com (Beijing) Technology Co., Ltd.

Room 102-1, Building No. 35

Courtyard No. 2, Xi'erqi West Road, Haidian District, Beijing  
CHINA

[74] BARRON & YOUNG INTELLECTUAL PROPERTY LIMITED

Suite 617, Lakeside 2

No. 10 Science Park West Avenue, Hong Kong Science Park,  
Shatin, N.T.

HONG KONG



- [11] 1913419.4M005  
[15] 10-04-2019  
[30] 11-10-2018 / CN / 201830568202.5  
[51] Cl. 14-04  
[54] 用於手機的圖形用戶界面  
Graphical user interface for mobile phone  
[73] 貝殼找房(北京)科技有限公司  
Ke.com (Beijing) Technology Co., Ltd.  
Room 102-1, Building No. 35  
Courtyard No. 2, Xi'erqi West Road, Haidian District, Beijing  
CHINA  
[74] BARRON & YOUNG INTELLECTUAL PROPERTY LIMITED  
Suite 617, Lakeside 2  
No. 10 Science Park West Avenue, Hong Kong Science Park,  
Shatin, N.T.  
HONG KONG

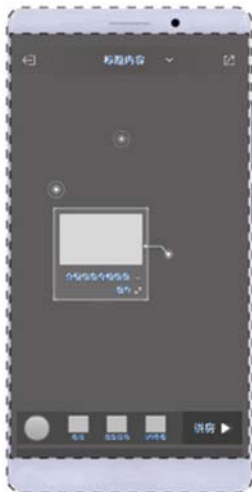

- 
- [11] 1913419.4M006  
[15] 10-04-2019  
[30] 11-10-2018 / CN / 201830568199.7  
[51] Cl. 14-04  
[54] 用於手機的圖形用戶界面  
Graphical user interface for mobile phone  
[73] 貝殼找房(北京)科技有限公司  
Ke.com (Beijing) Technology Co., Ltd.  
Room 102-1, Building No. 35  
Courtyard No. 2, Xi'erqi West Road, Haidian District, Beijing  
CHINA

- [74] BARRON & YOUNG INTELLECTUAL PROPERTY LIMITED  
Suite 617, Lakeside 2  
No. 10 Science Park West Avenue, Hong Kong Science Park,  
Shatin, N.T.  
HONG KONG



- 
- [11] 1913449.7  
[15] 15-04-2019  
[51] Cl. 25-01  
[54] 金屬製盲導標示  
Metal tactile marker  
[73] 加藍誘導標示有限公司  
香港北角  
英皇道 89 號  
桂洪集團中心 2802 室  
[74] 加藍誘導標示有限公司  
香港北角  
英皇道 89 號  
桂洪集團中心 2802 室





[11] 1913454.7

[15] 15-04-2019

[51] Cl. 6-13

[54] 吸盤矽膠隔熱墊

Smart grip silicone pad

[73] 盧健偉

LO KIN WAI DAVID

香港新界 火炭坳背

灣街 45 號

喜利佳工業大廈 7 樓 H 室

[74] LO KIN WAI DAVID

香港新界 火炭坳背

灣街 47 號

喜利佳工業大廈 7 樓 H 室



[11] 1913471.3

[15] 17-04-2019

[51] Cl. 11-01

[54] 首飾元件

Jewelry element

[73] GEORGE GERO

9350 Wilshire Blvd., Suite 313

Beverly Hills, CA 90212-3206

UNITED STATES

[74] WILKINSON & GRIST

6th Floor, Prince's Building

Chater Road

HONG KONG



---

[11] 1913486.5M001

[15] 19-04-2019

[51] Cl. 7-07

[54] 外帶食物盒連內置盒

Takeaway food box with internal box

[73] 潮安發展有限公司

Chase On Development Limited

Flat B-F, 23/F, Block 4, Golden Dragon Industrial Center

182-190 Tai Lin Pai Road, Kwai Chung, N.T.

HONG KONG

[74] GLOBAL INTELLECTUAL PROPERTY COMPANY LIMITED

Unit 2205, 22/F Sino Plaza,

255-257 Gloucester Road, Causeway Bay,

HONG KONG



---

[11] 1913486.5M002

[15] 19-04-2019

[51] Cl. 7-07

[54] 外帶食物盒連內置盒

Takeaway food box with internal box

[73] 潮安發展有限公司

Chase On Development Limited

Flat B-F, 23/F, Block 4, Golden Dragon Industrial Center

182-190 Tai Lin Pai Road, Kwai Chung, N.T.  
HONG KONG

[74] GLOBAL INTELLECTUAL PROPERTY COMPANY LIMITED  
Unit 2205, 22/F Sino Plaza,  
255-257 Gloucester Road, Causeway Bay,  
HONG KONG



---

[11] 1913532.4

[15] 26-04-2019

[51] Cl. 7-05

[54] 掛燙機

Garment steamer

[73] 加減零株式會社

PLUS MINUS ZERO CO., LTD.

日本國東京都

中央區京橋2丁目1番3號

京橋托拉斯塔8層

[74] Sunhope Intellectual Property Limited (ATTN TO Fiona Ko)  
ROOM 902, 9/F, QUALIPAK TOWER, NO. 121-122 CONNAUGHT ROAD  
WEST, HONG KONG

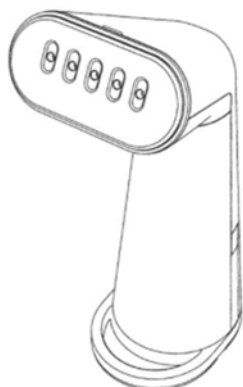

- [11] 1913583.1  
[15] 03-05-2019  
[30] 06-11-2018 / TW / 107306560  
[51] Cl. 7-01  
[54] 餐盒  
Lunch box  
[73] SUSHI EXPRESS CO.,LTD  
爭鮮股份有限公司  
台灣  
台北市信義區  
忠孝東路四段 559 巷 16 弄 21 號 1 樓  
[74] 宜知有限公司  
香港  
上環皇后大道西 23-25 號  
天威中心 21 樓



- 
- [11] 1913601.1  
[15] 08-05-2019  
[30] 12-11-2018 / EU, CA, JP, KR, SG, CH, GB, US, RU / DM/200 391  
[51] Cl. 25-03  
[54] 建築物  
Building  
[73] Bury Street Properties (Luxembourg) S.â.r.l.  
17-21, boulevard Joseph II, L-1840 Luxembourg, Luxembourg  
LUXEMBOURG  
[74] HUNG, AU YEUNG & PARTNERS  
Suite 2305, 23/F., Shun Feng International Centre,  
182 Queen's Road East, Wanchai  
HONG KONG



---

[11] 1913707.6

[15] 22-05-2019

[51] Cl. 28-03

[54] 震動按摩槍

Vibration massage

[73] Yell Group Limited

香港

長沙灣永康街 63 號

Global Gateway Tower 15 樓 5 室

[74] Yell Group Limited Ms. Susanne Luk

香港

長沙灣永康街 63 號

Global Gateway Tower 15 樓 5 室

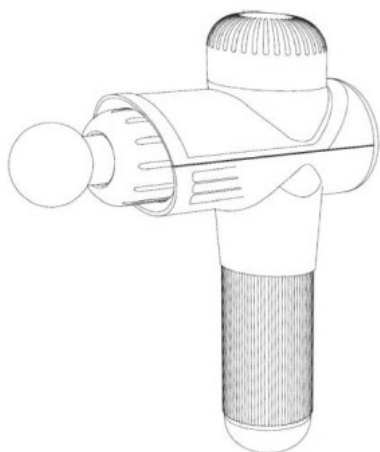

[11] 1913787.4

[15] 31-05-2019

[51] Cl. 3-04

[54] 超薄充電風扇

Rechargeable pocket slim fan

[73] Alun Christopher Jones

12/F, Room 4, Rhine Court, Block B,  
80 Bonham Road, Sai Ying Pun,  
Hong Kong

[74] Alun Christopher Jones

12/F, Room 4, Rhine Court, Block B,  
80 Bonham Road, Sai Ying Pun,  
Hong Kong

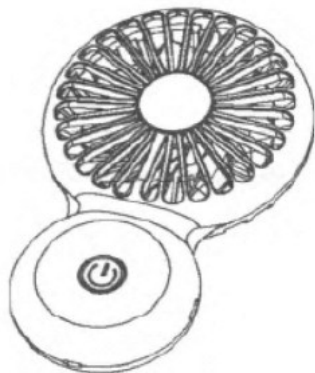

---

[11] 1913894.0

[15] 06-06-2019

[51] Cl. 28-03

[54] 震動按摩槍

Vibration massage device

[73] Yell Group Limited

香港

長沙灣永康街 63 號

Global Gateway Tower 15 樓 5 室

[74] Yell Group Limited (ATTN TO Susanne Luk)

香港

長沙灣永康街 63 號

Global Gateway Tower 15 樓 5 室

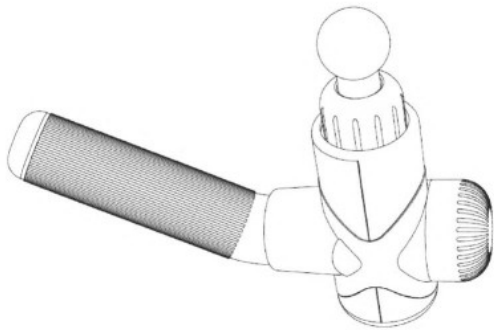

---

[11] 1913900.5M001

[15] 06-06-2019

[30] 13-12-2018 / EU, JP, KR, CH, GB / WIPO78207

[51] Cl. 11-01

[54] 戒指  
Ring

[73] Cartier International AG  
Hinterbergstrasse 22  
6312 STEINHAUSEN  
SWITZERLAND

[74] DEACONS  
5th Floor, Alexandra House  
Central  
HONG KONG

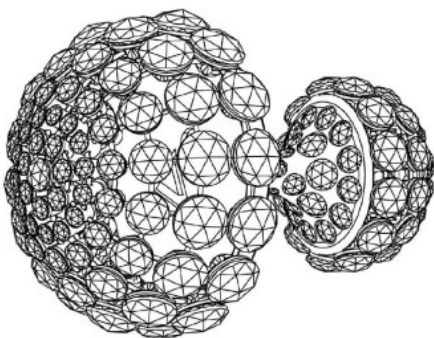

---

[11] 1913900.5M002

[15] 06-06-2019

[30] 13-12-2018 / WO / WIPO78207

[51] Cl. 11-01

[54] 裝飾元件

Decorative elements

[73] Cartier International AG

Hinterbergstrasse 22

6312 STEINHAUSEN

SWITZERLAND

[74] DEACONS

5th Floor, Alexandra House

Central

HONG KONG

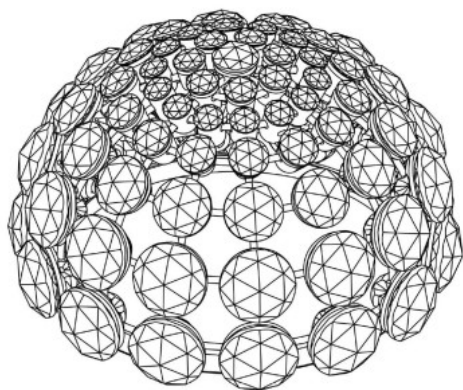

---

[11] 1913901.7

[15] 06-06-2019

[30] 12-12-2018 / EU, JP, KR, CH, GB / WIPO78117

[51] Cl. 11-01

[54] 裝飾元件

Decorative elements

[73] Cartier International AG

Hinterbergstrasse 22

6312 STEINHAUSEN

SWITZERLAND

[74] DEACONS

5th Floor, Alexandra House

Central

HONG KONG



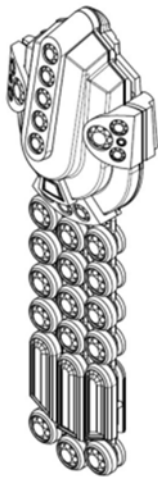

---

[11] 1913902.9

[15] 06-06-2019

[30] 12-12-2018 / EU, JP, KR, CH, GB / WIPO78120

[51] Cl. 11-01

[54] 手鐲

Bracelet

[73] Cartier International AG

Hinterbergstrasse 22

6312 STEINHAUSEN

SWITZERLAND

[74] DEACONS

5th Floor, Alexandra House

Central

HONG KONG



- [11] 1913903.1  
[15] 06-06-2019  
[30] 12-12-2018 / EU, JP, KR, CH, GB / WIPO78131  
[51] Cl. 11-01  
[54] 項鍊  
Necklace  
[73] Cartier International AG  
Hinterbergstrasse 22  
6312 STEINHAUSEN  
SWITZERLAND  
[74] DEACONS  
5th Floor, Alexandra House  
Central  
HONG KONG

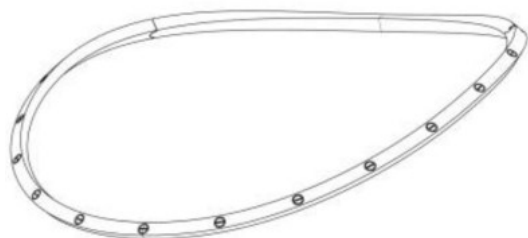

- 
- [11] 1914024.7M001  
[15] 18-06-2019  
[51] Cl. 11-01  
[54] 吊墜  
Pendant  
[73] 老鋪黃金(香港)有限公司  
LAO PU (HONG KONG) COMPANY LIMITED  
Room 801-2, 8/F, Easey Commercial Building,  
253-261 Hennessy Road, Wanchai,  
HONG KONG  
[74] SF LAWYERS  
UNIT 1125-1127, PRINCE'S BUILDING,  
10 CHATER ROAD, CENTRAL,  
HONG KONG



---

[11] 1914024.7M002

[15] 18-06-2019

[51] Cl. 11-01

[54] 吊墜

Pendant

[73] 老鋪黃金(香港)有限公司

LAO PU (HONG KONG) COMPANY LIMITED

Room 801-2, 8/F, Easey Commercial Building,

253-261 Hennessy Road, Wanchai,

HONG KONG

[74] SF LAWYERS

UNIT 1125-1127, PRINCE'S BUILDING,

10 CHATER ROAD, CENTRAL,

HONG KONG



---

[11] 1914031.2

[15] 19-06-2019

[30] 21-12-2018 / EU, CA, KR, SG, CH, TR / 970003737

[51] Cl. 10-05

- [54] 監控區域提供監控和監視功能的偵測裝置  
Detection apparatus for monitoring surveillance functions in  
monitoring area fields
- [73] Bureau d'Electronique Appliquée Société anonyme  
Allée des Noisetiers 5  
4031 Angleur  
BELGIUM
- [74] WENPING & CO  
1701 Tung Wai Commercial Building,  
111 Gloucester Road,  
HONG KONG

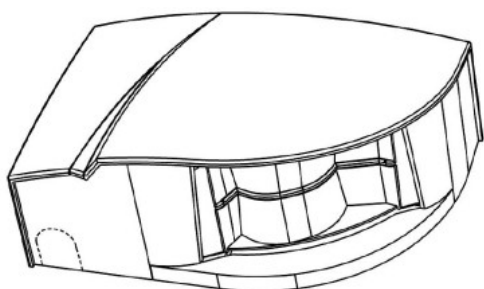

- 
- [11] 1914038.7
- [15] 20-06-2019
- [51] Cl. 13-02
- [54] 藍牙耳機充電倉  
Charger for wireless earphones
- [73] 深圳市建豐德聯科技有限公司  
SHENZHEN JIANFENGDELIAN TECHNOLOGY CO., LTD.  
中國內地 深圳市寶安區新安街  
道 靈芝新村 38 棟 B 座 401 室
- [74] 滙誠知識產權有限公司  
香港  
灣仔軒尼詩道 397 號  
東區商業大廈 1206 室



---

[11] 1914039.9M001

[15] 20-06-2019

[51] Cl. 16-06

[54] 太陽眼鏡

Sunglasses

[73] CHRISTIAN DIOR COUTURE

30 Avenue Montaigne, 75008 Paris

FRANCE

[74] WILKINSON & GRIST

6th Floor, Prince's Building

Chater Road

HONG KONG



---

[11] 1914039.9M002

[15] 20-06-2019

[51] Cl. 16-06

[54] 太陽眼鏡

Sunglasses

[73] CHRISTIAN DIOR COUTURE

30 Avenue Montaigne, 75008 Paris

FRANCE

[74] WILKINSON & GRIST  
6th Floor, Prince's Building  
Chater Road  
HONG KONG



---

[11] 1914041.3M001

[15] 20-06-2019

[30] 20-12-2018 / US / 29/674,258

[51] Cl. 14-04

[54] 帶有可轉變圖形用戶界面的顯示屏或其部分

Display or portion thereof with a transitional user interface

[73] HOLOGIC, INC.

250 Campus Drive

Marlborough, MA 01752

UNITED STATES

[74] BARRON & YOUNG INTELLECTUAL PROPERTY LIMITED

Suite 617, Lakeside 2

No. 10 Science Park West Avenue, Hong Kong Science Park,

Shatin, N.T.

HONG KONG

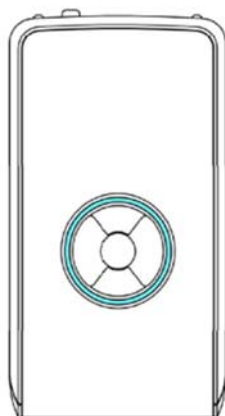

[11] 1914041.3M002

[15] 20-06-2019

[30] 20-12-2018 / US / 29/674,258

[51] Cl. 14-04

[54] 帶有可轉變圖形用戶界面的顯示屏或其部分

Display or portion thereof with a transitional user interface

[73] HOLOGIC, INC.

250 Campus Drive

Marlborough, MA 01752

UNITED STATES

[74] BARRON & YOUNG INTELLECTUAL PROPERTY LIMITED

Suite 617, Lakeside 2

No. 10 Science Park West Avenue, Hong Kong Science Park,

Shatin, N.T.

HONG KONG

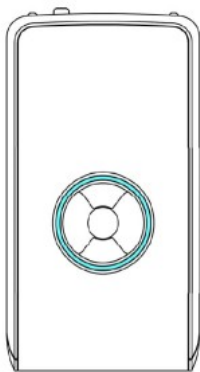

---

[11] 1914041.3M003

[15] 20-06-2019

[30] 20-12-2018 / US / 29/674,258

[51] Cl. 14-04

[54] 帶有可轉變圖形用戶界面的顯示屏或其部分

Display or portion thereof with a transitional user interface

[73] HOLOGIC, INC.

250 Campus Drive

Marlborough, MA 01752

UNITED STATES

[74] BARRON & YOUNG INTELLECTUAL PROPERTY LIMITED

Suite 617, Lakeside 2

No. 10 Science Park West Avenue, Hong Kong Science Park,

Shatin, N.T.

HONG KONG

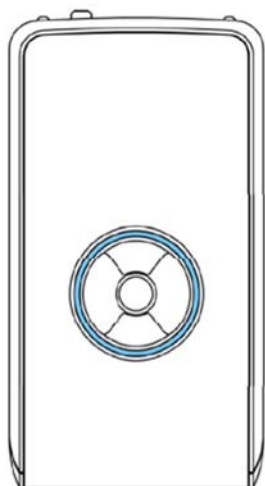

[11] 1914041.3M004

[15] 20-06-2019

[30] 20-12-2018 / US / 29/674,258

[51] Cl. 14-04

[54] 帶有可轉變圖形用戶界面的顯示屏或其部分

Display or portion thereof with a transitional user interface

[73] HOLOGIC, INC.

250 Campus Drive

Marlborough, MA 01752

UNITED STATES

[74] BARRON & YOUNG INTELLECTUAL PROPERTY LIMITED

Suite 617, Lakeside 2

No. 10 Science Park West Avenue, Hong Kong Science Park,

Shatin, N.T.

HONG KONG

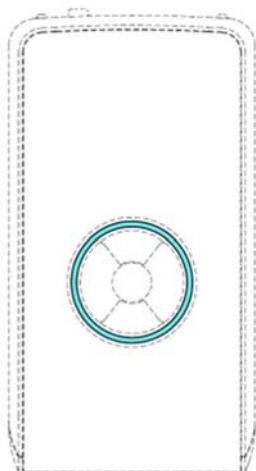



[11] 1914041.3M005

[15] 20-06-2019

[30] 20-12-2018 / US / 29/674,258

[51] Cl. 14-04

[54] 帶有可轉變圖形用戶界面的顯示屏或其部分

Display or portion thereof with a transitional user interface

[73] HOLOGIC, INC.

250 Campus Drive

Marlborough, MA 01752

UNITED STATES

[74] BARRON & YOUNG INTELLECTUAL PROPERTY LIMITED

Suite 617, Lakeside 2

No. 10 Science Park West Avenue, Hong Kong Science Park,  
Shatin, N.T.

HONG KONG

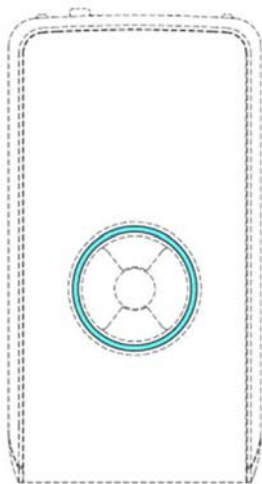

---

[11] 1914041.3M006

[15] 20-06-2019

[30] 20-12-2018 / US / 29/674,258

[51] Cl. 14-04

[54] 帶有可轉變圖形用戶界面的顯示屏或其部分

Display or portion thereof with a transitional user interface

[73] HOLOGIC, INC.

250 Campus Drive

Marlborough, MA 01752

UNITED STATES

[74] BARRON & YOUNG INTELLECTUAL PROPERTY LIMITED

Suite 617, Lakeside 2

No. 10 Science Park West Avenue, Hong Kong Science Park,

Shatin, N.T.  
HONG KONG

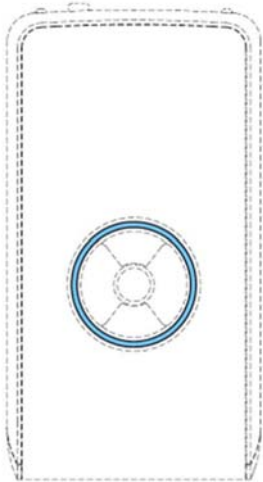

---

[11] 1914042.5

[15] 21-06-2019

[51] Cl. 28-03

[54] 按摩器具

Massage appliances

[73] Kabushikigaisha Shiseido (SHISEIDO Co., Ltd.)

5-5, Ginza 7-chome, Chuo-ku,

Tokyo, JAPAN

[74] MARKS & CLERK

Level 9, Cyberport 1

100 Cyberport Road, Pok Fu Lam

HONG KONG

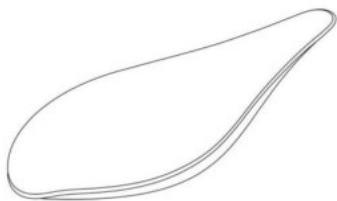

---

[11] 1914046.4M001

[15] 21-06-2019

[30] 25-12-2018 / CN / 201830755688.3

[51] Cl. 13-03

[54] 插座拖板

Trailing socket

[73] SCHNEIDER ELECTRIC (AUSTRALIA) PTY LTD

78 WATERLOO ROAD

MACQUARIE PARK, NSW 2113

AUSTRALIA

[74] WENPING & CO

1701 Tung Wai Commercial Building,

111 Gloucester Road,

HONG KONG

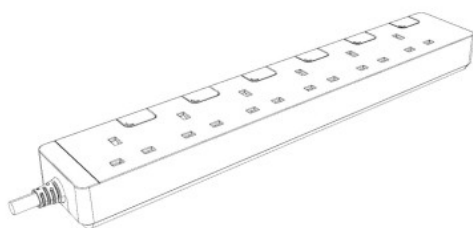

---

[11] 1914046.4M002

[15] 21-06-2019

[30] 25-12-2018 / CN / 201830755688.3

[51] Cl. 13-03

[54] 插座拖板

Trailing socket

[73] SCHNEIDER ELECTRIC (AUSTRALIA) PTY LTD

78 WATERLOO ROAD

MACQUARIE PARK, NSW 2113

AUSTRALIA

[74] WENPING & CO

1701 Tung Wai Commercial Building,

111 Gloucester Road,

HONG KONG

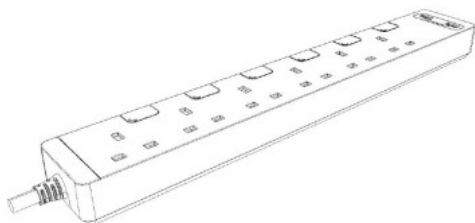

- [11] 1914046.4M003  
[15] 21-06-2019  
[30] 25-12-2018 / CN / 201830755688.3  
[51] Cl. 13-03  
[54] 插座拖板  
Trailing socket  
[73] SCHNEIDER ELECTRIC (AUSTRALIA) PTY LTD  
78 WATERLOO ROAD  
MACQUARIE PARK, NSW 2113  
AUSTRALIA  
[74] WENPING & CO  
1701 Tung Wai Commercial Building,  
111 Gloucester Road,  
HONG KONG

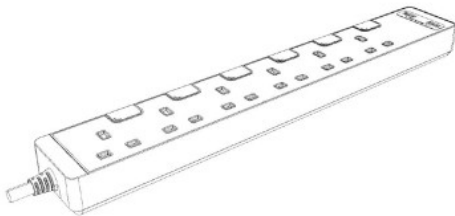

- 
- [11] 1914046.4M004  
[15] 21-06-2019  
[30] 25-12-2018 / CN / 201830755688.3  
[51] Cl. 13-03  
[54] 插座拖板  
Trailing socket  
[73] SCHNEIDER ELECTRIC (AUSTRALIA) PTY LTD  
78 WATERLOO ROAD  
MACQUARIE PARK, NSW 2113  
AUSTRALIA  
[74] WENPING & CO  
1701 Tung Wai Commercial Building,  
111 Gloucester Road,  
HONG KONG

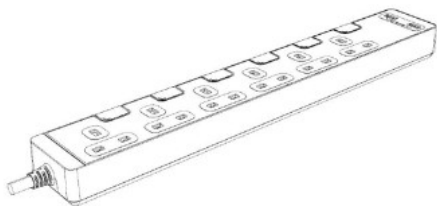

---

[11] 1914046.4M005

[15] 21-06-2019

[30] 25-12-2018 / CN / 201830755688.3

[51] Cl. 13-03

[54] 插座拖板

Trailing socket

[73] SCHNEIDER ELECTRIC (AUSTRALIA) PTY LTD

78 WATERLOO ROAD

MACQUARIE PARK, NSW 2113

AUSTRALIA

[74] WENPING & CO

1701 Tung Wai Commercial Building,

111 Gloucester Road,

HONG KONG

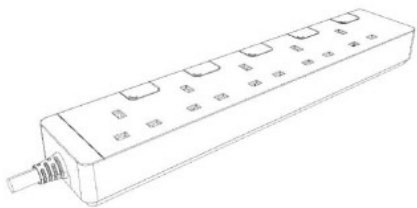

---

[11] 1914046.4M006

[15] 21-06-2019

[30] 25-12-2018 / CN / 201830755688.3

[51] Cl. 13-03

[54] 插座拖板

Trailing socket

[73] SCHNEIDER ELECTRIC (AUSTRALIA) PTY LTD  
78 WATERLOO ROAD  
MACQUARIE PARK, NSW 2113  
AUSTRALIA

[74] WENPING & CO  
1701 Tung Wai Commercial Building,  
111 Gloucester Road,  
HONG KONG

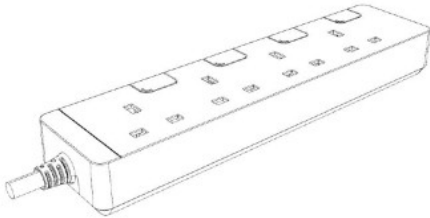

---

[11] 1914046.4M007

[15] 21-06-2019

[30] 25-12-2018 / CN / 201830755688.3

[51] Cl. 13-03

[54] 插座拖板

Trailing socket

[73] SCHNEIDER ELECTRIC (AUSTRALIA) PTY LTD  
78 WATERLOO ROAD  
MACQUARIE PARK, NSW 2113  
AUSTRALIA

[74] WENPING & CO  
1701 Tung Wai Commercial Building,  
111 Gloucester Road,  
HONG KONG

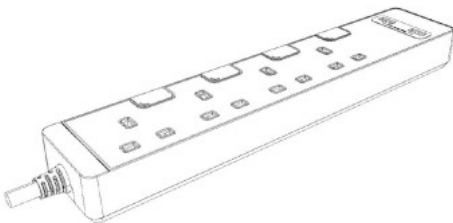

---

[11] 1914046.4M008

[15] 21-06-2019

[30] 25-12-2018 / CN / 201830755688.3

[51] Cl. 13-03

[54] 插座拖板

Trailing socket

[73] SCHNEIDER ELECTRIC (AUSTRALIA) PTY LTD

78 WATERLOO ROAD

MACQUARIE PARK, NSW 2113

AUSTRALIA

[74] WENPING & CO

1701 Tung Wai Commercial Building,

111 Gloucester Road,

HONG KONG

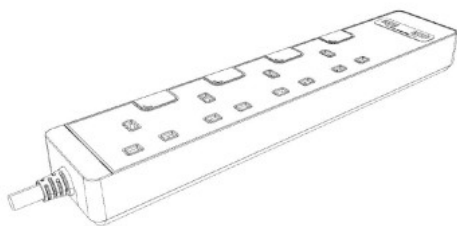

---

[11] 1914046.4M009

[15] 21-06-2019

[30] 25-12-2018 / CN / 201830755688.3

[51] Cl. 13-03

[54] 插座拖板

Trailing socket

[73] SCHNEIDER ELECTRIC (AUSTRALIA) PTY LTD

78 WATERLOO ROAD

MACQUARIE PARK, NSW 2113

AUSTRALIA

[74] WENPING & CO

1701 Tung Wai Commercial Building,

111 Gloucester Road,

HONG KONG



[11] 1914046.4M010

[15] 21-06-2019

[30] 25-12-2018 / CN / 201830755688.3

[51] Cl. 13-03

[54] 插座拖板

Trailing socket

[73] SCHNEIDER ELECTRIC (AUSTRALIA) PTY LTD

78 WATERLOO ROAD

MACQUARIE PARK, NSW 2113

AUSTRALIA

[74] WENPING & CO

1701 Tung Wai Commercial Building,

111 Gloucester Road,

HONG KONG

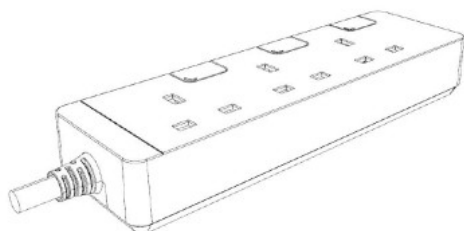

[11] 1914048.8M001

[15] 24-06-2019

[51] Cl. 19-06

[54] 原子筆

Pen

[73] Brand New Days Limited

Flat B, 6/F, Tong Yuen Factory Building

505 Castle Peak Road, Lai Chi Kok, Kowloon, Hong Kong

[74] Brand New Days Limited

Flat B, 6/F, Tong Yuen Factory Building

505 Castle Peak Road, Lai Chi Kok, Kowloon

HONG KONG





---

[11] 1914048.8M002

[15] 24-06-2019

[51] Cl. 19-06

[54] 原子筆

Pen

[73] Brand New Days Limited

Flat B, 6/F, Tong Yuen Factory Building

505 Castle Peak Road, Lai Chi Kok, Kowloon, Hong Kong

[74] Brand New Days Limited

Flat B, 6/F, Tong Yuen Factory Building

505 Castle Peak Road, Lai Chi Kok, Kowloon

HONG KONG



---

[11] 1914049.0

[15] 24-06-2019

[51] Cl. 11-01

[54] 手鐲

Bracelet

[73] 金花淑

KIM, Hwasook

212-705, 195 Mapodaero-ro, Mapo-gu, Seoul

KOREA, REPUBLIC OF

[74] NTD PATENT & TRADE MARK AGENCY LIMITED

Units 1805-6, 18/F., Greenfield Tower, Concordia Plaza, No. 1

Science Museum Road, Tsimshatsui East, Kowloon,

HONG KONG



---

[11] 1914050.2

[15] 24-06-2019

[51] Cl. 7-99

[54] 纸巾架

Paper towel holder

[73] 偉恆清潔用品有限公司

WISEHAND CLEANING PRODUCTS

香港

香港新界葵涌打磚坪街 68 號

和豐工業中心 11 樓 17 室

[74] 標準香港企業註冊服務有限公司

香港

香港九龍旺角彌敦道 678 號 華僑商業中

心 15C



---

[11] 1914051.4

[15] 24-06-2019

[51] Cl. 11-01

[54] 戒指

Ring

[73] 老鋪黃金(香港)有限公司

LAO PU (HONG KONG) COMPANY LIMITED

Room 801-2, 8/F, Easey Commercial Building,

253-261 Hennessy Road, Wanchai,

HONG KONG

[74] SF LAWYERS

UNIT 1125-1127, PRINCE'S BUILDING,

10 CHATER ROAD, CENTRAL,

HONG KONG



---

[11] 1914052.6

[15] 24-06-2019

[51] Cl. 11-01

[54] 吊墜

Pendant

[73] 老鋪黃金(香港)有限公司

LAO PU (HONG KONG) COMPANY LIMITED

Room 801-2, 8/F, Easey Commercial Building,  
253-261 Hennessy Road, Wanchai,  
HONG KONG

[74] SF LAWYERS  
UNIT 1125-1127, PRINCE'S BUILDING,  
10 CHATER ROAD, CENTRAL,  
HONG KONG



---

[11] 1914053.8

[15] 24-06-2019

[51] Cl. 11-02

[54] 裝飾物

Ornament

[73] 老鋪黃金(香港)有限公司  
LAO PU (HONG KONG) COMPANY LIMITED  
Room 801-2, 8/F, Easey Commercial Building,  
253-261 Hennessy Road, Wanchai,  
HONG KONG

[74] SF LAWYERS  
UNIT 1125-1127, PRINCE'S BUILDING,  
10 CHATER ROAD, CENTRAL,  
HONG KONG



---

[11] 1914054.0

[15] 24-06-2019

[51] Cl. 11-01

[54] 吊墜

Pendant

- [73] 老鋪黃金(香港)有限公司  
LAO PU (HONG KONG) COMPANY LIMITED  
Room 801-2, 8/F, Easey Commercial Building,  
253-261 Hennessy Road, Wanchai,  
HONG KONG
- [74] SF LAWYERS  
UNIT 1125-1127, PRINCE'S BUILDING,  
10 CHATER ROAD, CENTRAL,  
HONG KONG



- 
- [11] 1914055.3M001
- [15] 24-06-2019
- [51] Cl. 11-02
- [54] 裝飾物  
Ornament
- [73] 老鋪黃金(香港)有限公司  
LAO PU (HONG KONG) COMPANY LIMITED  
Room 801-2, 8/F, Easey Commercial Building,  
253-261 Hennessy Road, Wanchai,  
HONG KONG
- [74] SF LAWYERS  
UNIT 1125-1127, PRINCE'S BUILDING,  
10 CHATER ROAD, CENTRAL,  
HONG KONG



[11] 1914055.3M002

[15] 24-06-2019

[51] Cl. 11-02

[54] 裝飾物

Ornament

[73] 老鋪黃金(香港)有限公司

LAO PU (HONG KONG) COMPANY LIMITED

Room 801-2, 8/F, Easey Commercial Building,

253-261 Hennessy Road, Wanchai,

HONG KONG

[74] SF LAWYERS

UNIT 1125-1127, PRINCE'S BUILDING,

10 CHATER ROAD, CENTRAL,

HONG KONG



---

[11] 1914056.5M001

[15] 24-06-2019

[51] Cl. 11-02

[54] 裝飾物

Ornament

[73] 老鋪黃金(香港)有限公司

LAO PU (HONG KONG) COMPANY LIMITED

Room 801-2, 8/F, Easey Commercial Building,

253-261 Hennessy Road, Wanchai,

HONG KONG

[74] SF LAWYERS

UNIT 1125-1127, PRINCE'S BUILDING,

10 CHATER ROAD, CENTRAL,

HONG KONG



---

[11] 1914056.5M002

[15] 24-06-2019

[51] Cl. 11-02

[54] 裝飾物

Ornament

[73] 老鋪黃金(香港)有限公司

LAO PU (HONG KONG) COMPANY LIMITED

Room 801-2, 8/F, Easey Commercial Building,

253-261 Hennessy Road, Wanchai,

HONG KONG

[74] SF LAWYERS

UNIT 1125-1127, PRINCE'S BUILDING,

10 CHATER ROAD, CENTRAL,

HONG KONG



---

[11] 1914057.7M001

[15] 24-06-2019

[51] Cl. 11-01

[54] 手鏈

Bracelet

[73] 老鋪黃金(香港)有限公司  
LAO PU (HONG KONG) COMPANY LIMITED  
Room 801-2, 8/F, Easey Commercial Building,  
253-261 Hennessy Road, Wanchai,  
HONG KONG

[74] SF LAWYERS  
UNIT 1125-1127, PRINCE'S BUILDING,  
10 CHATER ROAD, CENTRAL,  
HONG KONG



---

[11] 1914057.7M002

[15] 24-06-2019

[51] Cl. 11-01

[54] 手鏈

Bracelet

[73] 老鋪黃金(香港)有限公司  
LAO PU (HONG KONG) COMPANY LIMITED  
Room 801-2, 8/F, Easey Commercial Building,  
253-261 Hennessy Road, Wanchai,  
HONG KONG

[74] SF LAWYERS  
UNIT 1125-1127, PRINCE'S BUILDING,  
10 CHATER ROAD, CENTRAL,  
HONG KONG



---

[11] 1914058.9M001



[15] 24-06-2019

[51] Cl. 11-01

[54] 手鐲

Bracelet

[73] 老鋪黃金(香港)有限公司

LAO PU (HONG KONG) COMPANY LIMITED

Room 801-2, 8/F, Easey Commercial Building,

253-261 Hennessy Road, Wanchai,

HONG KONG

[74] SF LAWYERS

UNIT 1125-1127, PRINCE'S BUILDING,

10 CHATER ROAD, CENTRAL,

HONG KONG



---

[11] 1914058.9M002

[15] 24-06-2019

[51] Cl. 11-01

[54] 手鐲

Bracelet

[73] 老鋪黃金(香港)有限公司

LAO PU (HONG KONG) COMPANY LIMITED

Room 801-2, 8/F, Easey Commercial Building,

253-261 Hennessy Road, Wanchai,

HONG KONG

[74] SF LAWYERS

UNIT 1125-1127, PRINCE'S BUILDING,

10 CHATER ROAD, CENTRAL,

HONG KONG



---

[11] 1914059.1

[15] 24-06-2019

[51] Cl. 11-01

[54] 手鐲

Bracelet

[73] 老鋪黃金(香港)有限公司

LAO PU (HONG KONG) COMPANY LIMITED

Room 801-2, 8/F, Easey Commercial Building,

253-261 Hennessy Road, Wanchai,

HONG KONG

[74] SF LAWYERS

UNIT 1125-1127, PRINCE'S BUILDING,

10 CHATER ROAD, CENTRAL,

HONG KONG



---

[11] 1914060.3

[15] 24-06-2019

[51] Cl. 11-01

[54] 手鐲

Bracelet

[73] 老鋪黃金(香港)有限公司

LAO PU (HONG KONG) COMPANY LIMITED

Room 801-2, 8/F, Easey Commercial Building,

253-261 Hennessy Road, Wanchai,  
HONG KONG

[74] SF LAWYERS  
UNIT 1125-1127, PRINCE'S BUILDING,  
10 CHATER ROAD, CENTRAL,  
HONG KONG



---

[11] 1914061.5

[15] 24-06-2019

[51] Cl. 11-01

[54] 吊墜

Pendant

[73] 老鋪黃金(香港)有限公司  
LAO PU (HONG KONG) COMPANY LIMITED  
Room 801-2, 8/F, Easey Commercial Building,  
253-261 Hennessy Road, Wanchai,  
HONG KONG

[74] SF LAWYERS  
UNIT 1125-1127, PRINCE'S BUILDING,  
10 CHATER ROAD, CENTRAL,  
HONG KONG



---

[11] 1914062.7

[15] 24-06-2019

[51] Cl. 11-01

[54] 吊墜

Pendant

- [73] 老鋪黃金(香港)有限公司  
LAO PU (HONG KONG) COMPANY LIMITED  
Room 801-2, 8/F, Easey Commercial Building,  
253-261 Hennessy Road, Wanchai,  
HONG KONG
- [74] SF LAWYERS  
UNIT 1125-1127, PRINCE'S BUILDING,  
10 CHATER ROAD, CENTRAL,  
HONG KONG



- 
- [11] 1914063.9M001  
[15] 24-06-2019  
[51] Cl. 11-01  
[54] 吊墜  
Pendant
- [73] 老鋪黃金(香港)有限公司  
LAO PU (HONG KONG) COMPANY LIMITED  
Room 801-2, 8/F, Easey Commercial Building,  
253-261 Hennessy Road, Wanchai,  
HONG KONG
- [74] SF LAWYERS  
UNIT 1125-1127, PRINCE'S BUILDING,  
10 CHATER ROAD, CENTRAL,  
HONG KONG



[11] 1914063.9M002

[15] 24-06-2019

[51] Cl. 11-01

[54] 吊墜

Pendant

[73] 老鋪黃金(香港)有限公司

LAO PU (HONG KONG) COMPANY LIMITED

Room 801-2, 8/F, Easey Commercial Building,

253-261 Hennessy Road, Wanchai,

HONG KONG

[74] SF LAWYERS

UNIT 1125-1127, PRINCE'S BUILDING,

10 CHATER ROAD, CENTRAL,

HONG KONG



---

[11] 1914064.1M001

[15] 24-06-2019

[51] Cl. 11-02

[54] 裝飾物

Ornament

[73] 老鋪黃金(香港)有限公司

LAO PU (HONG KONG) COMPANY LIMITED

Room 801-2, 8/F, Easey Commercial Building,

253-261 Hennessy Road, Wanchai,

HONG KONG

[74] SF LAWYERS

UNIT 1125-1127, PRINCE'S BUILDING,

10 CHATER ROAD, CENTRAL,

HONG KONG



---

[11] 1914064.1M002

[15] 24-06-2019

[51] Cl. 11-02

[54] 裝飾物

Ornament

[73] 老鋪黃金(香港)有限公司

LAO PU (HONG KONG) COMPANY LIMITED

Room 801-2, 8/F, Easey Commercial Building,

253-261 Hennessy Road, Wanchai,

HONG KONG

[74] SF LAWYERS

UNIT 1125-1127, PRINCE'S BUILDING,

10 CHATER ROAD, CENTRAL,

HONG KONG



---

[11] 1914064.1M003

[15] 24-06-2019

[51] Cl. 11-02

[54] 裝飾盒

Box ornament

[73] 老鋪黃金(香港)有限公司

LAO PU (HONG KONG) COMPANY LIMITED

Room 801-2, 8/F, Easey Commercial Building,

253-261 Hennessy Road, Wanchai,

HONG KONG

[74] SF LAWYERS

UNIT 1125-1127, PRINCE'S BUILDING,

10 CHATER ROAD, CENTRAL,

HONG KONG



---

[11] 1914065.4

[15] 24-06-2019

[51] Cl. 11-02

[54] 裝飾碗

Decorative bowl

[73] 老鋪黃金(香港)有限公司

LAO PU (HONG KONG) COMPANY LIMITED

Room 801-2, 8/F, Easey Commercial Building,

253-261 Hennessy Road, Wanchai,

HONG KONG

[74] SF LAWYERS

UNIT 1125-1127, PRINCE'S BUILDING,

10 CHATER ROAD, CENTRAL,

HONG KONG



---

[11] 1914070.4

[15] 25-06-2019

[51] Cl. 17-05

[54] 音樂盒

Musical box

[73] IMA TRANS LIMITED

Flat A, 11th Floor, Crawford Tower,  
99, Jervois Street, Sheung Wan, Hong Kong

[74] IMA TRANS LIMITED

Flat A, 11th Floor, Crawford Tower,  
99, Jervois Street, Sheung Wan, Hong Kong



---

[11] 1914071.6

[15] 25-06-2019

[30] 11-01-2019 / EU, MC, JP, KR, SG, CH, GB, US, RU / DM/200747

[51] Cl. 26-05

[54] 吊燈

Chandelier

[73] COMPAGNIE DES CRISTALLERIES DE SAINT-LOUIS Société par actions  
simplifiée

F-57620 SAINT-LOUIS LES BITCHE  
FRANCE



[74] DEACONS  
5th Floor, Alexandra House  
Central  
HONG KONG



---

[11] 1914072.8

[15] 25-06-2019

[30] 11-01-2019 / EU, MC, JP, KR, SG, CH, GB, US, RU / DM/200741

[51] Cl. 26-05

[54] 燈  
Lamp

[73] COMPAGNIE DES CRISTALLERIES DE SAINT-LOUIS Société par actions  
simplifiée  
F-57620 SAINT-LOUIS LES BITCHE  
FRANCE

[74] DEACONS  
5th Floor, Alexandra House  
Central  
HONG KONG



- [11] 1914073.0  
[15] 25-06-2019  
[30] 21-06-2019 / EM / 006588240  
[51] Cl. 3-01  
[54] 手機套  
Case for Mobile Phone  
[73] LOEWE S.A.  
Calle Goya 4  
28001 Madrid  
SPAIN  
[74] BAKER & MCKENZIE  
14TH FLOOR, ONE TAIKOO PLACE,  
979 KING'S ROAD, QUARRY BAY,  
HONG KONG



- 
- [11] 1914074.2  
[15] 25-06-2019  
[30] 09-01-2019 / EU, SG, CH, TR / DM/200648  
[51] Cl. 10-02  
[54] 手錶  
Wrist watch  
[73] Bell & Ross B.V.  
Gustav Mahlerlaan 1001,  
1082 MK Amsterdam,  
NETHERLANDS  
[74] ATL LAW OFFICES  
16/F., China Hong Kong Tower,  
8-12 Hennessy Road, Wanchai,  
HONG KONG



---

[11] 1914075.5

[15] 25-06-2019

[51] Cl. 14-03

[54] 對接站

Docking Station

[73] 深圳派立通科技有限公司

Shenzhen Pilot technology Co.,LTD  
中國內地 廣東省深圳市龍崗區平湖街道山廈  
社區 杉坑工業區杉坑路 7 號 A1 廠房二樓、三  
樓

[74] 中港專利有限公司

港灣道 1 號會展廣場辦公大樓 30 樓 3012 室  
HONG KONG  
HONG KONG



---

[11] 1914076.7

[15] 25-06-2019

[51] Cl. 14-03

[54] 對接站

Docking Station

[73] 深圳派立通科技有限公司

Shenzhen Pilot technology Co.,LTD

中國內地 廣東省深圳市龍崗區平湖街道山廈

社區 杉坑工業區杉坑路 7 號 A1 廠房二樓、三

樓

[74] 中港專利有限公司

港灣道 1 號會展廣場辦公大樓 30 樓 3012 室

HONG KONG

HONG KONG

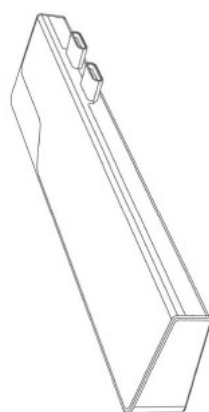

---

[11] 1914081.7

[15] 26-06-2019

[51] Cl. 28-02

[54] 用於化妝目的的面膜

Mask pack for cosmetic purposes

[73] 姜南錫

KANG NAM SEOK

大韓民國 京畿道楊州

市天寶山路 七十一番

街, 二二-七

[74] CHINAHONGKONG IP LIMITED

3011, 30/F, Office Tower, Convention Plaza, 1 Harbour Road

HONG KONG

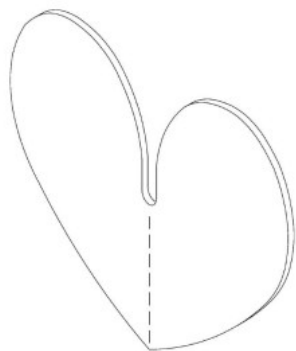

---

[11] 1914083.1

[15] 26-06-2019

[30] 27-12-2018 / AU / 201817900

[51] Cl. 26-06

[54] 汽車前組合燈

Front combination lamp for an automobile

[73] TOYOTA JIDOSHA KABUSHIKI KAISHA

1, Toyota-cho, Toyota-shi, Aichi-ken, 471-8571  
JAPAN

[74] CLT PATENT & TRADEMARK (H.K.) LIMITED

Unit 09, 34/F., Office Tower, Convention Plaza  
No. 1 Harbour Road, Wanchai  
HONG KONG



---

[11] 1914084.3

[15] 26-06-2019

[51] Cl. 10-02

[54] 手錶

Watch

[73] 萬希泉鐘錶有限公司

香港柴灣永泰道 60 號  
柴灣工業城第一期 8 樓 804 室

- [74] 萬希泉鐘錶有限公司  
香港柴灣永泰道 60 號  
柴灣工業城第一期 8 樓 804 室

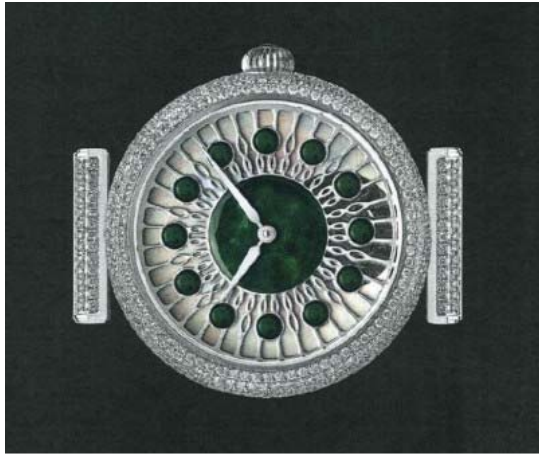

[11] 1914085.6

[15] 26-06-2019

[51] Cl. 10-02

[54] 手錶

Watch

- [73] 萬希泉鐘錶有限公司  
香港柴灣永泰道 60 號  
柴灣工業城第一期 8 樓 804 室

- [74] 萬希泉鐘錶有限公司  
香港柴灣永泰道 60 號  
柴灣工業城第一期 8 樓 804 室

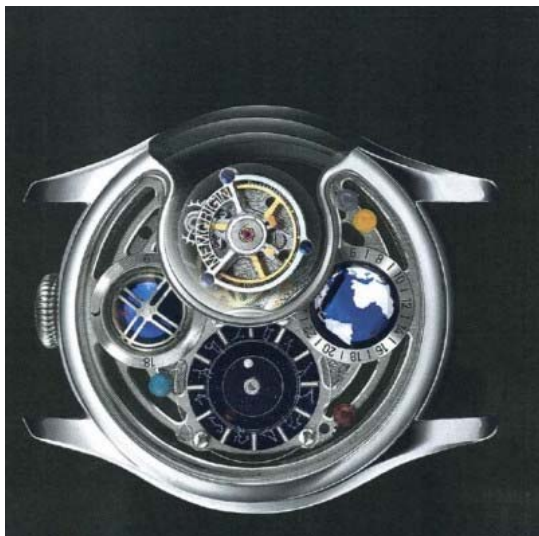

[11] 1914086.8M001

[15] 26-06-2019

[30] 27-12-2018 / FR / 2018-5723

[51] Cl. 9-01

[54] 香水瓶

Perfume bottle

[73] CELINE

16 rue Vivienne

75002 Paris

FRANCE

[74] EAGLE IP LIMITED

Room 509, Global Gateway Tower,

63 Wing Hong Street, Lai Chi Kok, Kowloon,

HONG KONG

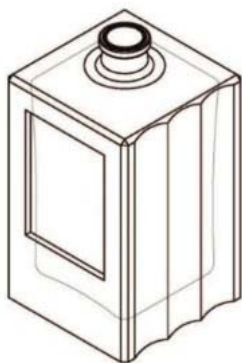

---

[11] 1914086.8M002

[15] 26-06-2019

[30] 27-12-2018 / FR / 2018-5723

[51] Cl. 9-01

[54] 香水瓶

Perfume bottle

[73] CELINE

16 rue Vivienne

75002 Paris

FRANCE

[74] EAGLE IP LIMITED

Room 509, Global Gateway Tower,

63 Wing Hong Street, Lai Chi Kok, Kowloon,

HONG KONG

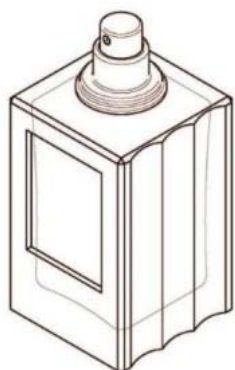

---

[11] 1914086.8M003

[15] 26-06-2019

[30] 27-12-2018 / FR / 2018-5723

[51] Cl. 9-01

[54] 香水瓶

Perfume bottle

[73] CELINE

16 rue Vivienne

75002 Paris

FRANCE

[74] EAGLE IP LIMITED

Room 509, Global Gateway Tower,

63 Wing Hong Street, Lai Chi Kok, Kowloon,

HONG KONG

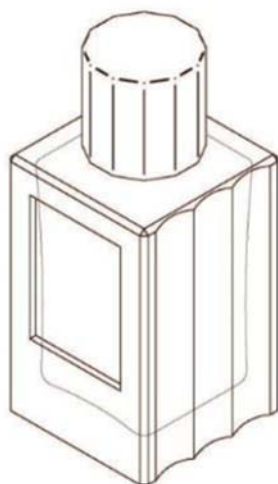

---

[11] 1914090.6

[15] 27-06-2019



[30] 27-12-2018 / US / 29/674,978

[51] Cl. 24-04

[54] 具有加熱及震動功能的護背

Back brace with heating and vibration

[73] HYPER ICE, INC.

15440 LAGUNA CANYON ROAD, SUITE 230

IRVINE, CALIFORNIA 92618

UNITED STATES

[74] CHINA PATENT AGENT (HONG KONG) LIMITED

22/F, Great Eagle Centre, 23 Harbour Road, Wanchai

HONG KONG

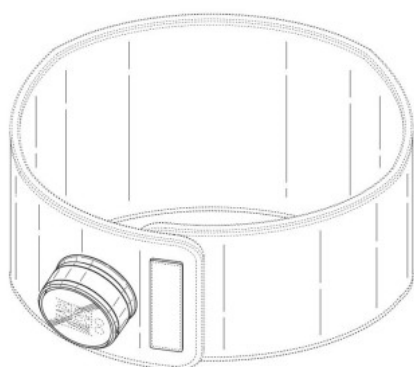

---

[11] 1914092.0

[15] 28-06-2019

[30] 04-02-2019 / JP / 2019 of 002194

[51] Cl. 30-99

[54] 寵物用廁所

Pet toilet

[73] 株式會社利其爾

RICHELL CORPORATION

日本

富山縣富山市

水橋櫻木 136 番地

[74] 中國專利代理(香港)有限公司

香港

灣仔港灣道 23 號

鷹君中心 22 字樓

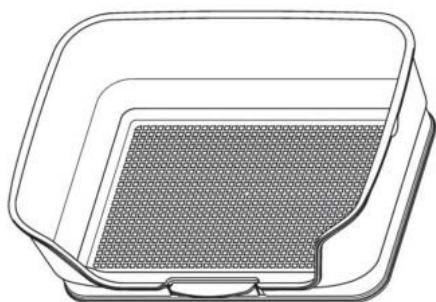

---

[11] 1914093.2

[15] 28-06-2019

[30] 04-02-2019 / JP / 2019 of 002177

[51] Cl. 6-01

[54] 嬰兒椅

Baby Chair

[73] 株式會社利其爾

RICHELL CORPORATION

日本 富山縣富

山市

水橋櫻木 136 番地

[74] 中國專利代理(香港)有限公司

香港

灣仔港灣道 23 號

鷹君中心 22 字樓



---

[11] 1914094.4

[15] 28-06-2019

[30] 23-01-2019 / EM / 006082491-0003

[51] Cl. 14-01

[54] 耳機

Headphones

[73] Sennheiser electronic GmbH & Co. KG

Am Labor 1

30900 Wedemark, Germany

GERMANY

[74] UNITALEN ATTORNEYS AT LAW LIMITED

RM 1201, 12/F,

GOLDEN ERA PLAZA,

39-55 SAI YEE ST, MONGKOK KLN

HONG KONG

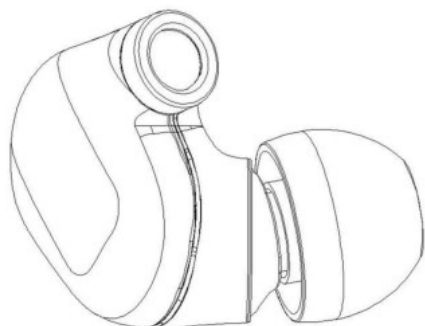

---

[11] 1914095.7M001

[15] 28-06-2019

[30] 05-06-2019 / CN / 201930288712.1

[51] Cl. 13-03

[54] 升降機門的操作板

Operation panel for elevator gate

[73] Toshiba Elevator Kabushiki Kaisha

72-34, Horikawa-cho, Saiwai-ku

Kawasaki-shi

Kanagawa

JAPAN

[74] DEACONS

5th Floor, Alexandra House

Central

HONG KONG

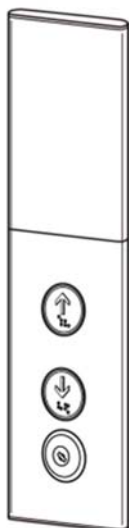

[11] 1914095.7M002

[15] 28-06-2019

[30] 05-06-2019 / CN / 201930288712.1

[51] Cl. 13-03

[54] 升降機門的操作板

Operation panel for elevator gate

[73] Toshiba Elevator Kabushiki Kaisha

72-34, Horikawa-cho, Saiwai-ku

Kawasaki-shi

Kanagawa

JAPAN

[74] DEACONS

5th Floor, Alexandra House

Central

HONG KONG

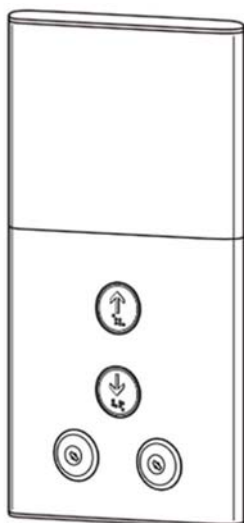

[11] 1914095.7M003

[15] 28-06-2019

[30] 05-06-2019 / CN / 201930288712.1

[51] Cl. 13-03

[54] 升降機門的操作板

Operation panel for elevator gate

[73] Toshiba Elevator Kabushiki Kaisha

72-34, Horikawa-cho, Saiwai-ku

Kawasaki-shi

Kanagawa

JAPAN

[74] DEACONS

5th Floor, Alexandra House

Central

HONG KONG

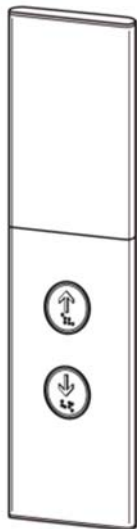

---

[11] 1914095.7M004

[15] 28-06-2019

[30] 05-06-2019 / CN / 201930288712.1

[51] Cl. 13-03

[54] 升降機門的操作板

Operation panel for elevator gate

[73] Toshiba Elevator Kabushiki Kaisha

72-34, Horikawa-cho, Saiwai-ku

Kawasaki-shi

Kanagawa

JAPAN

[74] DEACONS

5th Floor, Alexandra House

Central  
HONG KONG

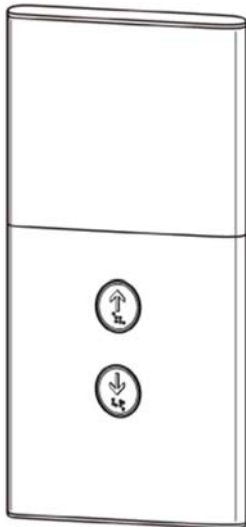

---

[11] 1914096.9M001

[15] 28-06-2019

[30] 30-01-2019 / EU, AZ, MC, AL, AM, BZ, GE, BA, LI, MN, ME, MA,  
NO, OM, MD, SG, CH, TN, UA, GB, TR, KG, MK / DM/200 690

[51] Cl. 10-07

[54] 自動盤

Oscillating weight

[73] Harry Winston SA

Chemin du Tourbillon 8, CH-1228 Plan-les-Ouates,  
SWITZERLAND

[74] SPRUSON & FERGUSON (HONG KONG) LIMITED

5001 Hopewell Centre

183 Queen's Road East, Wan Chai

HONG KONG

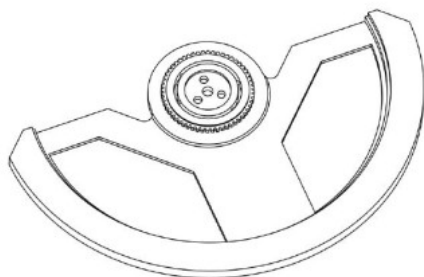

---

[11] 1914096.9M002

[15] 28-06-2019

[30] 30-01-2019 / EU, AZ, MC, AL, AM, BZ, GE, BA, LI, MN, ME, MA,  
NO, OM, MD, SG, CH, TN, UA, GB, TR, KG, MK / DM/200 690

[51] Cl. 10-07

[54] 錶面  
Dial

[73] Harry Winston SA  
Chemin du Tourbillon 8, CH-1228 Plan-les-Ouates,  
SWITZERLAND

[74] SPRUSON & FERGUSON (HONG KONG) LIMITED  
5001 Hopewell Centre  
183 Queen's Road East, Wan Chai  
HONG KONG



---

[11] 1914096.9M003

[15] 28-06-2019

[30] 30-01-2019 / EU, AZ, MC, AL, AM, BZ, GE, BA, LI, MN, ME, MA,  
NO, OM, MD, SG, CH, TN, UA, GB, TR, KG, MK / DM/200 690

[51] Cl. 10-07

[54] 錶面  
Dial

[73] Harry Winston SA  
Chemin du Tourbillon 8, CH-1228 Plan-les-Ouates,  
SWITZERLAND

[74] SPRUSON & FERGUSON (HONG KONG) LIMITED  
5001 Hopewell Centre  
183 Queen's Road East, Wan Chai  
HONG KONG

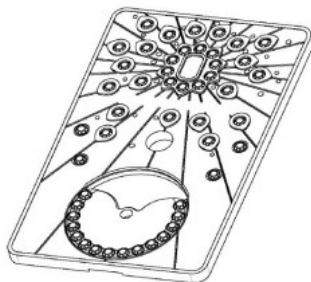

---

[11] 1914096.9M004

[15] 28-06-2019

[30] 30-01-2019 / EU, AZ, MC, AL, AM, BZ, GE, BA, LI, MN, ME, MA,  
NO, OM, MD, SG, CH, TN, UA, GB, TR, KG, MK / DM/200 690

[51] Cl. 10-07

[54] 錶面  
Dial

[73] Harry Winston SA  
Chemin du Tourbillon 8, CH-1228 Plan-les-Ouates,  
SWITZERLAND

[74] SPRUSON & FERGUSON (HONG KONG) LIMITED  
5001 Hopewell Centre  
183 Queen's Road East, Wan Chai  
HONG KONG

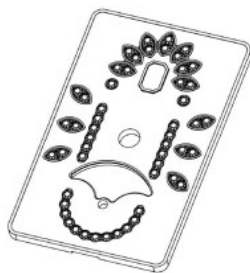

---

[11] 1914096.9M005

[15] 28-06-2019

[30] 30-01-2019 / EU, AZ, MC, AL, AM, BZ, GE, BA, LI, MN, ME, MA,  
NO, OM, MD, SG, CH, TN, UA, GB, TR, KG, MK / DM/200 690

[51] Cl. 10-07



[54] 錶面

Dial

[73] Harry Winston SA

Chemin du Tourbillon 8, CH-1228 Plan-les-Ouates,  
SWITZERLAND

[74] SPRUSON & FERGUSON (HONG KONG) LIMITED

5001 Hopewell Centre  
183 Queen's Road East, Wan Chai  
HONG KONG

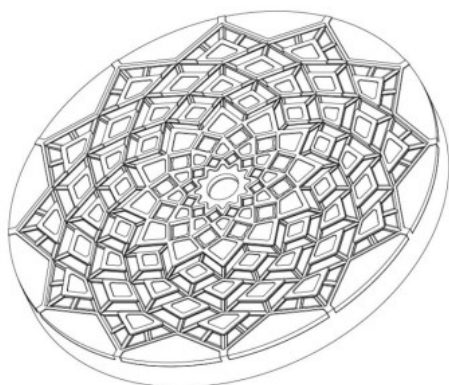

---

[11] 1914096.9M006

[15] 28-06-2019

[30] 30-01-2019 / EU, AZ, MC, AL, AM, BZ, GE, BA, LI, MN, ME, MA,  
NO, OM, MD, SG, CH, TN, UA, GB, TR, KG, MK / DM/200 690

[51] Cl. 10-07

[54] 錶殼連錶帶

Watch case with bracelet

[73] Harry Winston SA

Chemin du Tourbillon 8, CH-1228 Plan-les-Ouates,  
SWITZERLAND

[74] SPRUSON & FERGUSON (HONG KONG) LIMITED

5001 Hopewell Centre  
183 Queen's Road East, Wan Chai  
HONG KONG



---

[11] 1914097.1

[15] 28-06-2019

[51] Cl. 3-01

[54] 行李箱

Luggage

[73] 新秀麗 IP 控股有限責任公司

Samsonite IP Holdings S.à r.l.

13-15 avenue de la Liberté

L-1931 Luxembourg

LUXEMBOURG

[74] WILKINSON & GRIST

6th Floor, Prince's Building

Chater Road

HONG KONG

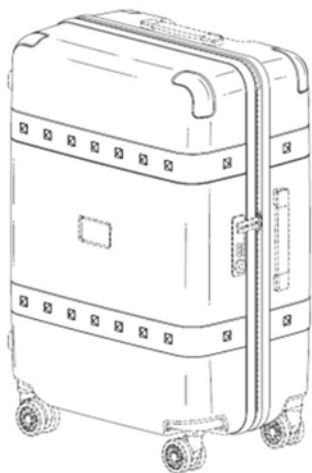





香港特別行政區政府知識產權署外觀設計註冊處

The Government of the Hong Kong Special Administrative Region

Designs Registry, Intellectual Property Department

根據註冊外觀設計條例第 28 條，下列註冊外觀設計因未繳續期費而停止有效。各組記項按註冊外觀設計停止有效日期及註冊編號先後次序排列。

**Registered designs ceased through non-payment of renewal fees under section 28 of the Registered Designs Ordinance. Entries are listed below under their expiry dates.**

**15-11-2019 - 20-11-2019**

<b>15-11-2019</b>	1402128.9M002
0412584.5M003	1402128.9M003
0901924.9	1402128.9M004
	1402128.9M005

**16-11-2019**

0412607.6M001  
0412607.6M002  
0412607.6M003  
0412607.6M004  
0412607.6M005  
0412607.6M006  
0412607.6M007  
0412607.6M008  
0412607.6M009  
0412607.6M010  
0412607.6M011  
0412607.6M012  
0901927.6  
0901934.0M001  
0901934.0M002  
1402117.6  
1402119.0

**19-11-2019**

1402130.3M001  
1402130.3M002  
1402130.3M003  
1402130.3M004  
1402134.1M001  
1402134.1M002  
1402137.8  
1402138.0

**20-11-2019**

1402139.2M001  
1402139.2M002  
1402141.6  
1402142.8  
1402143.0  
1402146.7M001  
1402146.7M002

**17-11-2019**

0901938.9M001  
0901938.9M002  
1402120.2M001  
1402120.2M002  
1402120.2M003  
1402122.6

**18-11-2019**

1402127.7  
1402128.9M001



香港特別行政區政府知識產權署外觀設計註冊處

The Government of the Hong Kong Special Administrative Region

Designs Registry, Intellectual Property Department

根據註冊外觀設計規則第 31 條刪除的註冊外觀設計。各組記項按註冊外觀設計 刪除日期及註冊編號先後次序排列。

**Registered designs removed under section 31 of the Registered Designs Rules. Entries are listed below under their removal dates.**

**22-11-2019 - 28-11-2019**

<b>22-11-2019</b>	1402101.2	1400917.1M001
0411086.8		1400917.1M002
0411087.0	<b>23-11-2019</b>	1400917.1M003
0411088.2	1400911.8	1400917.1M004
1400822.9M001	1400912.0M001	1400917.1M005
1400822.9M002	1400912.0M002	1400917.1M006
1400822.9M003	1400913.2	1400917.1M007
1400822.9M004	1400914.4M001	1400917.1M008
1400822.9M005	1400914.4M002	1400918.3
1400822.9M006	1400914.4M003	1400919.5
1400822.9M007	1400914.4M004	1400920.7
1400822.9M008	1400914.4M005	1400921.9
1400822.9M009		1400922.1
1400822.9M010	<b>24-11-2019</b>	1400923.3
1400823.1M001	0411097.1	
1400823.1M002	1400915.7	<b>27-11-2019</b>
1400823.1M003		0411127.6
1400823.1M004	<b>25-11-2019</b>	0900811.9M001
1400823.1M005	0900799.2M001	0900811.9M002
1400823.1M006	0900799.2M002	0900811.9M003
1400823.1M007	9910592.4	0900811.9M004
1400823.1M008		0900811.9M005
1400824.3M001	<b>26-11-2019</b>	0900811.9M006
1400824.3M004	0411118.7	0900811.9M007
1400826.8M002	0411121.3	0900811.9M008
1400827.0	0411122.5	0900811.9M009
1400902.9	0411123.7M001	0900811.9M010
1400903.1M001	0411123.7M002	0900817.2M001
1400909.4M001	0411123.7M003	0900817.2M002
1400909.4M002	0411123.7M004	1400926.0M001
1400909.4M003	0411123.7M005	1400928.4
1400909.4M004	0411123.7M006	1400929.6M001
1400909.4M005	0900808.3	1400929.6M002
1400909.4M006	0900809.5M002	

**28-11-2019**

0900821.0

0900823.4M002

0900823.4M004

0900823.4M005

0900823.4M009

1400932.2M001

1400932.2M002

1400932.2M003

1400932.2M004

1400933.4M001

1400933.4M002

1400933.4M003

1400933.4M004

1400933.4M005

1400935.9

1400936.1

9910630.6

9910631.8