

香港知識產權公報

Hong Kong Intellectual Property Journal

2020年10月16日
16 October 2020



目錄 Contents

根據註冊外觀設計條例第 25 條註冊的外觀設計

Designs Registered under section 25 of the Registered Designs Ordinance

按註冊編號排列

Arranged by Registration Number

根據註冊外觀設計條例(第 522 章)公布的其他公告

Other Notices Published under the Registered Designs Ordinance (Cap. 522)

根據註冊外觀設計條例第 28 條，註冊外觀設計因未繳續期費而停止有效

Registered designs ceased through non-payment of renewal fees under section 28 of the Registered Designs Ordinance

根據註冊外觀設計規則第 31 條刪除的註冊外觀設計

Registered designs removed under section 31 of the Registered Designs Rules

根據註冊外觀設計條例第 76 條，更正已提交文件中的錯誤

Correction of errors in filed documents under section 76 of the Registered Designs Ordinance

以下事項沒有記錄

No Records for the Following Matters

根據註冊外觀設計條例第 30 條放棄的外觀設計的註冊

Surrender of Registration of Design under section 30 of the Registered Designs Ordinance

根據註冊外觀設計規則第 37 條，向處長作出轉介

Reference to Registrar under section 37 of the Registered Designs Rules

根據註冊外觀設計條例第 45 條，撤銷註冊

Revocation of Registration under section 45 of the Registered Designs Ordinance

根據註冊外觀設計規則第 46 條，向法院作出轉介

Reference to Court under section 46 of the Registered Designs Rules

根據註冊外觀設計規則第 63 條對不符合規定之處作出糾正

Rectification of Irregularities under section 63 of the Registered Designs Rules

根據註冊外觀設計條例第 66 條，糾正註冊紀錄冊

Rectification of Register under section 66 of the Registered Designs Ordinance

根據註冊外觀設計條例第 67 條 更正註冊紀錄冊內的錯誤

Correction of errors in Register under section 67 of the Registered Designs Ordinance

根據註冊外觀設計條例第 67 及 76 條，更正註冊紀錄冊內及已提交文件中的錯誤

Correction of Errors in Register and in Filed Documents under sections 67 and 76 of the Registered Designs Ordinance

勘誤

Corrigendum

註冊外觀設計公告註釋

Notes on advertisements of registration of designs

方括號表示下列資料：

Square brackets indicate the following data：

[11] 註冊編號 Registration number / 聯合王國註冊編號 United Kingdom registration number

[15] 註冊日期 Registration date / 當作註冊日期 Deemed registration date / 聯合王國註冊日期 United Kingdom registration date

[17] 註冊有效期屆滿日期 Expiry date of the period of registration

[22] 提交日期 Filing date / 當作提交日期 Deemed filing date / 聯合王國提交日期 United Kingdom filing date

[30] 聲稱享有的優先權（提交日期 / 巴黎公約國或世界貿易組織成員 / 申請編號） Priority claimed (filing date / Paris Convention country or WTO member / application number)

[51] 國際外觀設計分類號（洛迦諾分類號） International Classification of designs (Locarno Classification)

[54] 物品 Article

[55] 外觀設計的表述 Representation of the design

[62] 分開前的申請編號及提交日期 Application number before division and filing date

[66] 過往註冊的聯繫外觀設計註冊編號 / 日期 Registration No. / Date of Previous Registration for Association

[72] 設計人 Designer

[73] 擁有人姓名和地址 Name and address of the owner

[74] 代理人 Agent / 送達地址 Address for service



香港特別行政區政府知識產權署外觀設計註冊處

The Government of the Hong Kong Special Administrative Region

Designs Registry, Intellectual Property Department

根據註冊外觀設計條例第 25 條註冊的外觀設計

Designs registered under section 25 of the Registered Designs Ordinance

按註冊編號排列

Arranged by Registration Number

[11] 1914505.9

[15] 21-08-2019

[30] 21-02-2019 / US / 29/681,014

[51] Cl. 24-01

[54] 分析裝置

Analytical device

[73] PROMAXO, INC.

70 WASHINGTON STREET,

SUITE 407, OAKLAND, CALIFORNIA 94607

UNITED STATES

[74] WILKINSON & GRIST

6th Floor, Prince's Building

Chater Road

HONG KONG

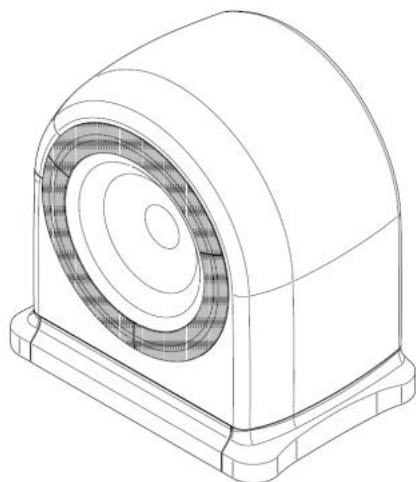

[11] 2015785.5M001

[15] 16-03-2020

- [51] Cl. 19-99
Cl. 19-07
Cl. 19-06
Cl. 19-04
Cl. 19-03
Cl. 19-02
Cl. 19-01
- [54] 用於書寫紙、明信片 and 通知卡、辦公設備、日曆、書本、用於繪圖的材料、教學材料及設備、文件夾、公文袋、筆、間尺、貼紙、印章、筆袋及拉鍊袋的圖案設計
Pattern design use on writing paper, cards for correspondence and announcements, office equipment, calendars, books, materials and instruments for drawing, teaching material and apparatus, folder, envelope, sticker, stamp, pencil bag and zipping bag
- [73] 聖雅各福群會
香港灣仔
石水渠街 85 號
聖雅各福群會總會大樓十樓
- [74] 聖雅各福群會
香港灣仔
石水渠街 85 號
聖雅各福群會總會大樓十樓



樂觀
Optimism

-
- [11] 2015785.5M002
- [15] 16-03-2020
- [51] Cl. 19-99
Cl. 19-07
Cl. 19-06
Cl. 19-04
Cl. 19-03

C1. 19-02

C1. 19-01

- [54] 用於書寫紙、明信片 and 通知卡、辦公設備、日曆、書本、用於繪圖的材料、教學材料及設備、文件夾、公文袋、筆、間尺、貼紙、印章、筆袋及拉鍊袋的圖案設計

Pattern design use on writing paper, cards for correspondence and announcements, office equipment, calendars, books, materials and instruments for drawing, teaching material and apparatus, folder, envelope, sticker, stamp, pencil bag and zipping bag

- [73] 聖雅各福群會

香港灣仔

石水渠街 85 號

聖雅各福群會總會大樓十樓

- [74] 聖雅各福群會

香港灣仔

石水渠街 85 號

聖雅各福群會總會大樓十樓



感恩
Thankfulness

- [11] 2015785.5M003

- [15] 16-03-2020

- [51] C1. 19-99

C1. 19-07

C1. 19-06

C1. 19-04

C1. 19-03

C1. 19-02

C1. 19-01

- [54] 用於書寫紙、明信片 and 通知卡、辦公設備、日曆、書本、用於繪圖的材料、教學材料及設備、文件夾、公文袋、筆、間尺、貼紙、印章、筆袋及拉鍊袋的圖案設計

Pattern design use on writing paper, cards for correspondence and announcements, office equipment, calendars, books,

materials and instruments for drawing, teaching material and apparatus, folder, envelope, sticker, stamp, pencil bag and zipping bag

- [73] 聖雅各福群會
香港灣仔
石水渠街 85 號
聖雅各福群會總會大樓十樓
- [74] 聖雅各福群會
香港灣仔
石水渠街 85 號
聖雅各福群會總會大樓十樓



正向情緒

Positive Emotions

-
- [11] 2015785.5M004
- [15] 16-03-2020
- [51] Cl. 19-99
Cl. 19-07
Cl. 19-06
Cl. 19-04
Cl. 19-03
Cl. 19-02
Cl. 19-01
- [54] 用於書寫紙、明信片 and 通知卡、辦公設備、日曆、書本、用於繪圖的材料、教學材料及設備、文件夾、公文袋、筆、間尺、貼紙、印章、筆袋及拉鍊袋的圖案設計
Pattern design use on writing paper, cards for correspondence and announcements, office equipment, calendars, books, materials and instruments for drawing, teaching material and apparatus, folder, envelope, sticker, stamp, pencil bag and zipping bag
- [73] 聖雅各福群會
香港灣仔

石水渠街 85 號
聖雅各福群會總會大樓十樓

- [74] 聖雅各福群會
香港灣仔
石水渠街 85 號
聖雅各福群會總會大樓十樓

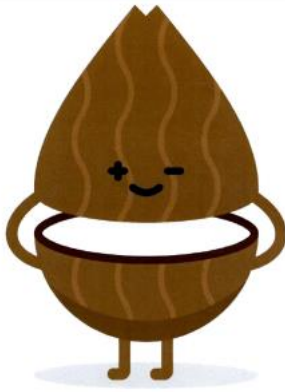

堅毅
Perseverance

-
- [11] 2015785.5M005
[15] 16-03-2020
[51] Cl. 19-99
Cl. 19-07
Cl. 19-06
Cl. 19-04
Cl. 19-03
Cl. 19-02
Cl. 19-01
[54] 用於書寫紙、明信片 and 通知卡、辦公設備、日曆、書本、用於繪圖的材料、教學材料及設備、文件夾、公文袋、筆、間尺、貼紙、印章、筆袋及拉鍊袋的圖案設計
Pattern design use on writing paper, cards for correspondence and announcements, office equipment, calendars, books, materials and instruments for drawing, teaching material and apparatus, folder, envelope, sticker, stamp, pencil bag and zipping bag
[73] 聖雅各福群會
香港灣仔
石水渠街 85 號
聖雅各福群會總會大樓十樓
[74] 聖雅各福群會
香港灣仔

石水渠街 85 號
聖雅各福群會總會大樓十樓



關愛

Care

[11] 2015785.5M006

[15] 16-03-2020

[51] Cl. 19-99

Cl. 19-07

Cl. 19-06

Cl. 19-04

Cl. 19-03

Cl. 19-02

Cl. 19-01

[54] 用於書寫紙、明信片 and 通知卡、辦公設備、日曆、書本、用於繪圖的材料、教學材料及設備、文件夾、公文袋、筆、間尺、貼紙、印章、筆袋及拉鍊袋的圖案設計

Pattern design use on writing paper, cards for correspondence and announcements, office equipment, calendars, books, materials and instruments for drawing, teaching material and apparatus, folder, envelope, sticker, stamp, pencil bag and zipping bag

[73] 聖雅各福群會

香港灣仔

石水渠街 85 號

聖雅各福群會總會大樓十樓

[74] 聖雅各福群會

香港灣仔

石水渠街 85 號

聖雅各福群會總會大樓十樓



專注力
Concentration

[11] 2015785.5M007

[15] 16-03-2020

[51] Cl. 19-99

Cl. 19-07

Cl. 19-06

Cl. 19-04

Cl. 19-03

Cl. 19-02

Cl. 19-01

[54] 用於書寫紙、明信片 and 通知卡、辦公設備、日曆、書本、用於繪圖的材料、教學材料及設備、文件夾、公文袋、筆、間尺、貼紙、印章、筆袋及拉鍊袋的圖案設計
Pattern design use on writing paper, cards for correspondence and announcements, office equipment, calendars, books, materials and instruments for drawing, teaching material and apparatus, folder, envelope, sticker, stamp, pencil bag and zipping bag

[73] 聖雅各福群會

香港灣仔

石水渠街 85 號

聖雅各福群會總會大樓十樓

[74] 聖雅各福群會

香港灣仔

石水渠街 85 號

聖雅各福群會總會大樓十樓



察覺力
Observation

[11] 2015785.5M008

[15] 16-03-2020

[51] Cl. 19-99

Cl. 19-07

Cl. 19-06

Cl. 19-04

Cl. 19-03

Cl. 19-02

Cl. 19-01

[54] 用於書寫紙、明信片 and 通知卡、辦公設備、日曆、書本、用於繪圖的材料、教學材料及設備、文件夾、公文袋、筆、間尺、貼紙、印章、筆袋及拉鍊袋的圖案設計
Pattern design use on writing paper, cards for correspondence and announcements, office equipment, calendars, books, materials and instruments for drawing, teaching material and apparatus, folder, envelope, sticker, stamp, pencil bag and zipping bag

[73] 聖雅各福群會

香港灣仔

石水渠街 85 號

聖雅各福群會總會大樓十樓

[74] 聖雅各福群會

香港灣仔

石水渠街 85 號

聖雅各福群會總會大樓十樓

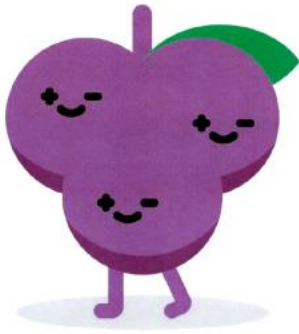

連結力
Connection

[11] 2015785.5M009

[15] 16-03-2020

[51] Cl. 19-99

Cl. 19-07

Cl. 19-06

Cl. 19-04

Cl. 19-03

Cl. 19-02

Cl. 19-01

[54] 用於書寫紙、明信片 and 通知卡、辦公設備、日曆、書本、用於繪圖的材料、教學材料及設備、文件夾、公文袋、筆、間尺、貼紙、印章、筆袋及拉鍊袋的圖案設計
Pattern design use on writing paper, cards for correspondence and announcements, office equipment, calendars, books, materials and instruments for drawing, teaching material and apparatus, folder, envelope, sticker, stamp, pencil bag and zipping bag

[73] 聖雅各福群會

香港灣仔

石水渠街 85 號

聖雅各福群會總會大樓十樓

[74] 聖雅各福群會

香港灣仔

石水渠街 85 號

聖雅各福群會總會大樓十樓



抗逆力
Resilience

[11] 2015785.5M010

[15] 16-03-2020

[51] Cl. 19-99

Cl. 19-07

Cl. 19-06

Cl. 19-04

Cl. 19-03

Cl. 19-02

Cl. 19-01

[54] 用於書寫紙、明信片 and 通知卡、辦公設備、日曆、書本、用於繪圖的材料、教學材料及設備、文件夾、公文袋、筆、間尺、貼紙、印章、筆袋及拉鍊袋的圖案設計
Pattern design use on writing paper, cards for correspondence and announcements, office equipment, calendars, books, materials and instruments for drawing, teaching material and apparatus, folder, envelope, sticker, stamp, pencil bag and zipping bag

[73] 聖雅各福群會

香港灣仔

石水渠街 85 號

聖雅各福群會總會大樓十樓

[74] 聖雅各福群會

香港灣仔

石水渠街 85 號

聖雅各福群會總會大樓十樓



創造力
Creativity

[11] 2015876.8

[15] 30-03-2020

[30] 02-10-2019 / FR / 2019-4297

[51] Cl. 3-01

[54] 袋
Bag

[73] LOUIS VUITTON MALLETIER
2 rue du Pont-Neuf,
75001 Paris,
FRANCE

[74] BAKER & MCKENZIE
14th Floor, One Taikoo Place,
979 King's Raod,
Quarry Bay, Hong Kong



- [11] 2016044.4M001
[15] 24-04-2020
[30] 20-04-2020 / CN / 202030161064.6
[51] Cl. 13-02
[54] 無線充電移動電源
Wireless charging mobile power supply
[73] 廣東高普達集團股份有限公司
GUANGDONG GOPOD GROUP CO., LTD
中國內地
深圳市龍華新區
大浪街道同勝社區華榮路聯建科技工業園廠房 8 棟 4,5,6 樓
[74] 中一聯合國際知識產權有限公司
香港九龍尖沙咀
漆咸道南 45-51 號
其士大廈 803 室

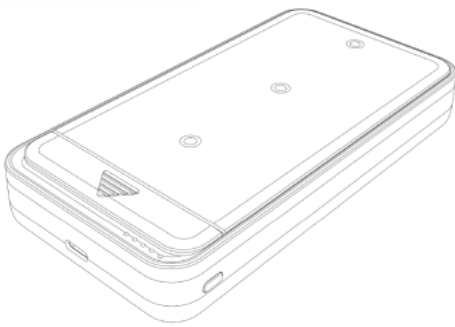

-
- [11] 2016044.4M002
[15] 24-04-2020
[30] 20-04-2020 / CN / 202030161064.6
[51] Cl. 13-02
[54] 無線充電移動電源
Wireless charging mobile power supply
[73] 廣東高普達集團股份有限公司
GUANGDONG GOPOD GROUP CO., LTD
中國內地
深圳市龍華新區
大浪街道同勝社區華榮路聯建科技工業園廠房 8 棟 4,5,6 樓
[74] 中一聯合國際知識產權有限公司
香港九龍尖沙咀
漆咸道南 45-51 號
其士大廈 803 室

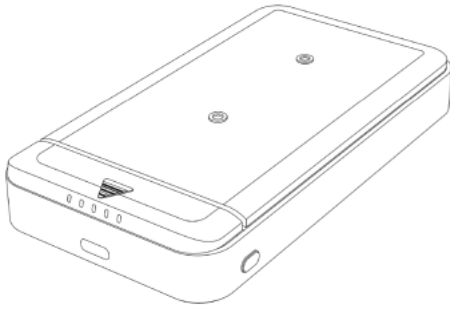

[11] 2016044.4M003

[15] 24-04-2020

[30] 20-04-2020 / CN / 202030161064.6

[51] C1. 13-02

[54] 無線充電移動電源

Wireless charging mobile power supply

[73] 廣東高普達集團股份有限公司

GUANGDONG GOPOD GROUP CO., LTD

中國內地

深圳市龍華新區

大浪街道同勝社區華榮路聯建科技工業園廠房 8 棟 4,5,6 樓

[74] 中一聯合國際知識產權有限公司

香港九龍尖沙咀

漆咸道南 45-51 號

其士大廈 803 室

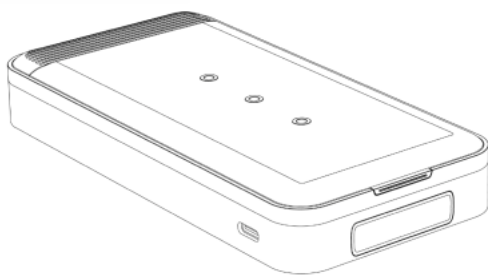

[11] 2016152.3

[15] 15-05-2020

[30] 05-12-2019 / EU / 007342217-0001

[51] C1. 21-01

[54] 玩具的冠狀轉輪

Crown spinner gear for toy

[73] Chiswick Innovations Limited
7 Chesterfield Road, London, Greater London, MIDDX W4 3HG,
United Kingdom

[74] UNITALEN ATTORNEYS AT LAW LIMITED
Rm 1201, 12/F, Golden Era Plaza,
39-55 Sai Yee St,
Mongkok, Kln, Hong Kong

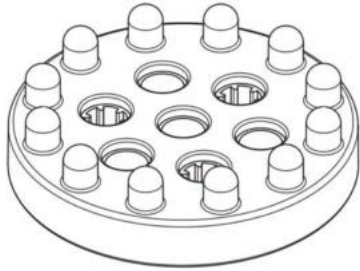

[11] 2016282.8

[15] 05-06-2020

[30] 06-12-2019 / CH / 145059

[51] Cl. 10-07

[54] 錶面

Watch dial

[73] Parmigiani Fleurier S.A.
Rue du Temple 11,
2114 Fleurier,
Switzerland

[74] UNION PATENT SERVICE CENTRE
Units E-F, 20th Floor, Neich Tower,
128 Gloucester Road,
Hong Kong

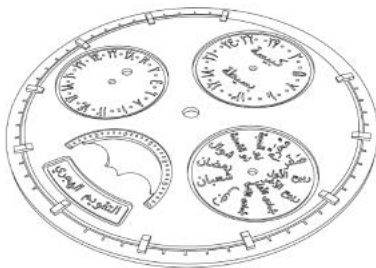

[11] 2016385.7M001

[15] 22-06-2020

[30] 23-12-2019 / AU / 201917405

[51] Cl. 7-01

[54] 飲用容器

Drinking vessel

[73] Muzjo Pty Ltd

92 Warner's Avenue,

Bondi Beach 2026 NSW Australia,

Australia

[74] BAKER & MCKENZIE

14th Floor, One Taikoo Place,

979 King's Road,

Quarry Bay, Hong Kong

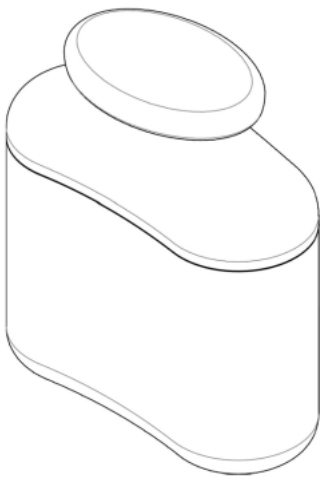

[11] 2016385.7M002

[15] 22-06-2020

[30] 23-12-2019 / AU / 201917405

[51] Cl. 7-01

[54] 飲用容器

Drinking vessel

[73] Muzjo Pty Ltd

92 Warner's Avenue,

Bondi Beach 2026 NSW Australia,

Australia

[74] BAKER & MCKENZIE

14th Floor, One Taikoo Place,

979 King's Road,

Quarry Bay, Hong Kong

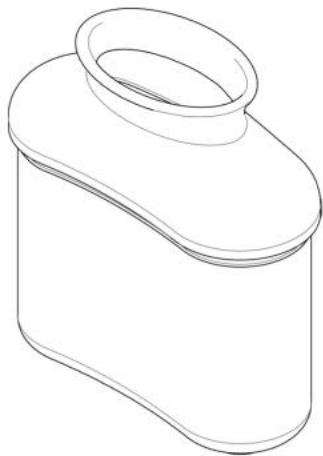

[11] 2016391.9

[15] 23-06-2020

[51] Cl. 31-00

[54] 多功能恆溫飲品沖泡機

Multiple functions beverage brewer

[73] 好健康紅茶供應商有限公司

GOOD HEALTH BEVERAGE HK LTD

G/F, 1A JULIA AVENUE,

TUNG LUNG COURT,

KOWLOON, HONG KONG

[74] Fung Yuen Pun Michael

G/F, 1A JULIA AVENUE,

TUNG LUNG COURT,

KOWLOON, HONG KONG

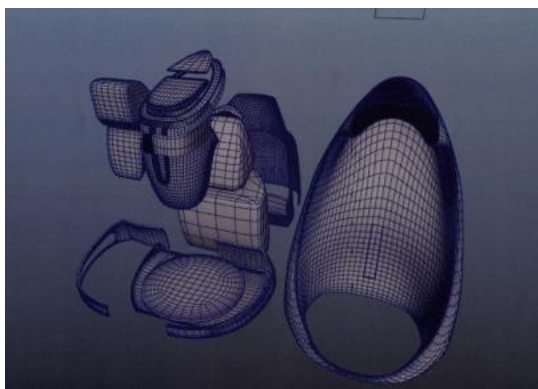

[11] 2016398.4M001

[15] 24-06-2020

[30] 24-12-2019 / EU / 007447438

- [51] Cl. 9-03
- [54] 包裝用裝飾
Ornamentation for packaging
- [73] Essity Hygiene and Health Aktiebolag
Molndals bro 2,
SE-405 03 Goteborg,
Sweden
- [74] UNITALEN ATTORNEYS AT LAW LIMITED
Rm 1201, 12/F, Golden Era Plaza,
39-55 Sai Yee St,
Mongkok, Kln, Hong Kong



-
- [11] 2016398.4M002
- [15] 24-06-2020
- [30] 24-12-2019 / EU / 007447438
- [51] Cl. 9-03
- [54] 包裝用裝飾
Ornamentation for packaging
- [73] Essity Hygiene and Health Aktiebolag
Molndals bro 2,
SE-405 03 Goteborg,
Sweden
- [74] UNITALEN ATTORNEYS AT LAW LIMITED
Rm 1201, 12/F, Golden Era Plaza,
39-55 Sai Yee St,
Mongkok, Kln, Hong Kong



-
- [11] 2016401.2
 - [15] 24-06-2020
 - [30] 24-12-2019 / US / 29/718,426
 - [51] Cl. 14-01
 - [54] 揚聲器
Soundbar
 - [73] Bose Corporation
The Mountain, MS 3B1,
Framingham, Massachusetts 01701-9168,
United States
 - [74] WENPING PATENT & TRADE MARK AGENT LIMITED
1701 Tung Wai Commercial Building,
111 Gloucester Road,
Hong Kong

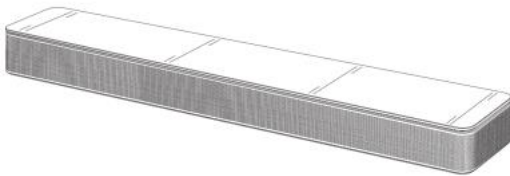

-
- [11] 2016435.4M001
 - [15] 03-07-2020
 - [30] 07-02-2020 / CA, AM, AZ, BZ, BA, GE, LI, MK, MD, MC, MN, ME,
NO, OM, SG, CH, TN, TR, UA, GB, EU, AL, KG / DM/206 569
 - [51] Cl. 10-07
 - [54] 錶面
Dial
 - [73] Harry Winston SA
Chemin du Tourbillon 8,

CH-1228 Plan-les-Ouates,
Switzerland

[74] SPRUSON & FERGUSON (HONG KONG) LIMITED
5001 Hopewell Centre,
183 Queen's Road East,
Wan Chai, Hong Kong

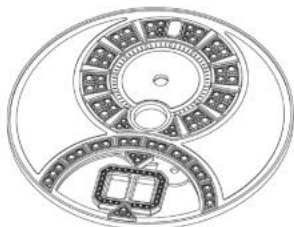

[11] 2016435.4M002

[15] 03-07-2020

[30] 07-02-2020 / KG, AL, EU, GB, UA, TR, TN, CH, SG, OM, NO, ME,
MN, MC, MD, MK, LI, GE, BA, BZ, AZ, AM, CA / DM/206 569

[51] Cl. 10-07

[54] 錶面
Dial

[73] Harry Winston SA
Chemin du Tourbillon 8,
CH-1228 Plan-les-Ouates,
Switzerland

[74] SPRUSON & FERGUSON (HONG KONG) LIMITED
5001 Hopewell Centre,
183 Queen's Road East,
Wan Chai, Hong Kong



[11] 2016435.4M003

[15] 03-07-2020

[30] 07-02-2020 / CA, AM, AZ, BZ, BA, GE, LI, MK, MD, MC, MN, ME,
NO, OM, SG, CH, TN, TR, UA, GB, EU, AL, KG / DM/206 569

[51] Cl. 10-07

[54] 錶殼

Watch case

[73] Harry Winston SA

Chemin du Tourbillon 8,
CH-1228 Plan-les-Ouates,
Switzerland

[74] SPRUSON & FERGUSON (HONG KONG) LIMITED

5001 Hopewell Centre,
183 Queen's Road East,
Wan Chai, Hong Kong

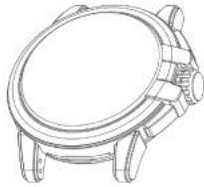

[11] 2016435.4M004

[15] 03-07-2020

[30] 07-02-2020 / CA, AM, AZ, BZ, BA, GE, LI, MK, MD, MC, MN, ME,
NO, OM, SG, CH, TN, TR, UA, GB, EU, AL, KG / DM/206 569

[51] Cl. 10-07

[54] 錶面

Dial

[73] Harry Winston SA

Chemin du Tourbillon 8,
CH-1228 Plan-les-Ouates,
Switzerland

[74] SPRUSON & FERGUSON (HONG KONG) LIMITED

5001 Hopewell Centre,
183 Queen's Road East,
Wan Chai, Hong Kong



[11] 2016435.4M005

[15] 03-07-2020

[30] 07-02-2020 / CA, AM, AZ, BZ, BA, GE, LI, MK, MD, MC, MN, ME,
NO, OM, SG, CH, TN, TR, UA, GB, EU, AL, KG / DM/206 569

[51] Cl. 10-07

[54] 錶面
Dial

[73] Harry Winston SA
Chemin du Tourbillon 8,
CH-1228 Plan-les-Ouates,
Switzerland

[74] SPRUSON & FERGUSON (HONG KONG) LIMITED
5001 Hopewell Centre,
183 Queen's Road East,
Wan Chai, Hong Kong



[11] 2016435.4M006

[15] 03-07-2020

[30] 07-02-2020 / CA, AM, AZ, BZ, BA, GE, LI, MK, MD, MC, MN, ME,
NO, OM, SG, CH, TN, TR, UA, GB, EU, AL, KG / DM/206 569

[51] Cl. 10-07

[54] 錶面
Dial

- [73] Harry Winston SA
Chemin du Tourbillon 8,
CH-1228 Plan-les-Ouates,
Switzerland
- [74] SPRUSON & FERGUSON (HONG KONG) LIMITED
5001 Hopewell Centre,
183 Queen's Road East,
Wan Chai, Hong Kong



-
- [11] 2016435.4M007
- [15] 03-07-2020
- [30] 07-02-2020 / CA, AM, AZ, BZ, BA, GE, LI, MK, MD, MC, MN, ME,
NO, OM, SG, CH, TN, TR, UA, GB, EU, AL, KG / DM/206 569
- [51] Cl. 10-07
- [54] 錶面
Dial
- [73] Harry Winston SA
Chemin du Tourbillon 8,
CH-1228 Plan-les-Ouates,
Switzerland
- [74] SPRUSON & FERGUSON (HONG KONG) LIMITED
5001 Hopewell Centre,
183 Queen's Road East,
Wan Chai, Hong Kong

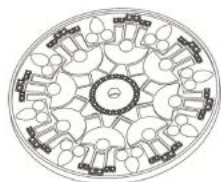

- [11] 2016435.4M008
- [15] 03-07-2020
- [30] 07-02-2020 / CA, AM, AZ, BZ, BA, GE, LI, MK, MD, MC, MN, ME,
NO, OM, SG, CH, TN, TR, UA, GB, EU, AL, KG / DM/206 569
- [51] Cl. 10-07
- [54] 錶面
Dial
- [73] Harry Winston SA
Chemin du Tourbillon 8,
CH-1228 Plan-les-Ouates,
Switzerland
- [74] SPRUSON & FERGUSON (HONG KONG) LIMITED
5001 Hopewell Centre,
183 Queen's Road East,
Wan Chai, Hong Kong



-
- [11] 2016435.4M009
- [15] 03-07-2020
- [30] 07-02-2020 / CA, AM, AZ, BZ, BA, GE, LI, MK, MD, MC, MN, ME,
NO, OM, SG, CH, TN, TR, UA, GB, EU, AL, KG / DM/206 569
- [51] Cl. 10-07
- [54] 錶面
Dial
- [73] Harry Winston SA
Chemin du Tourbillon 8,
CH-1228 Plan-les-Ouates,
Switzerland
- [74] SPRUSON & FERGUSON (HONG KONG) LIMITED
5001 Hopewell Centre,
183 Queen's Road East,
Wan Chai, Hong Kong



[11] 2016435.4M010

[15] 03-07-2020

[30] 07-02-2020 / CA, AM, AZ, BZ, BA, GE, LI, MK, MD, MC, MN, ME,
NO, OM, SG, CH, TN, TR, UA, GB, EU, AL, KG / DM/206 569

[51] Cl. 10-07

[54] 錶面
Dial

[73] Harry Winston SA
Chemin du Tourbillon 8,
CH-1228 Plan-les-Ouates,
Switzerland

[74] SPRUSON & FERGUSON (HONG KONG) LIMITED
5001 Hopewell Centre,
183 Queen's Road East,
Wan Chai, Hong Kong



[11] 2016435.4M011

[15] 03-07-2020

[30] 07-02-2020 / CA, AM, AZ, BZ, BA, GE, LI, MK, MD, MC, MN, ME,
NO, OM, SG, CH, TN, TR, UA, GB, EU, AL, KG / DM/206 569

[51] Cl. 10-07

[54] 錶面
Dial

[73] Harry Winston SA
Chemin du Tourbillon 8,
CH-1228 Plan-les-Ouates,
Switzerland

[74] SPRUSON & FERGUSON (HONG KONG) LIMITED
5001 Hopewell Centre,
183 Queen's Road East,
Wan Chai, Hong Kong



[11] 2016435.4M012

[15] 03-07-2020

[30] 07-02-2020 / CA, AM, AZ, BZ, BA, GE, LI, MK, MD, MC, MN, ME,
NO, OM, SG, CH, TN, TR, UA, GB, EU, AL, KG / DM/206 569

[51] Cl. 10-07

[54] 錶面
Dial

[73] Harry Winston SA
Chemin du Tourbillon 8,
CH-1228 Plan-les-Ouates,
Switzerland

[74] SPRUSON & FERGUSON (HONG KONG) LIMITED
5001 Hopewell Centre,
183 Queen's Road East,
Wan Chai, Hong Kong

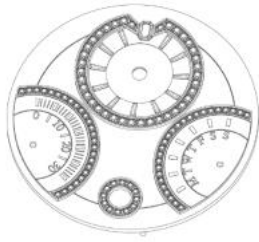

[11] 2016440.4M001

[15] 06-07-2020

[51] Cl. 12-16

[54] 用於空運貨物的覆蓋網連扣

Net for covering air cargo with buckle

[73] 進興國際貿易有限公司

Advance Gain International Trading Company Limited

Room D, 10/F, Tower A, Billion Centre,

1 Wang Kwong Road,

Kowloon Bay, Kowloon, Hong Kong

[74] Law Wai Lun

Flat 601-602, Block 1, Yip On Factory Estate,

Wang Hoi Road,

Kowloon Bay, Kowloon, Hong Kong

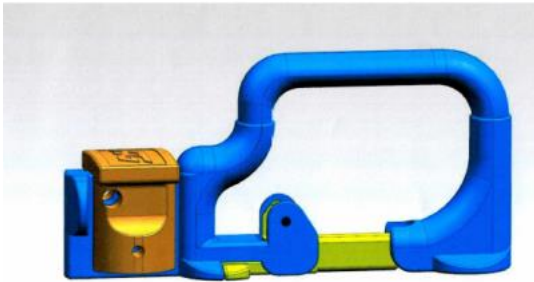

[11] 2016440.4M002

[15] 06-07-2020

[51] Cl. 12-16

[54] 用於空運貨物的覆蓋網連扣

Net for covering air cargo with buckle

[73] 進興國際貿易有限公司

Advance Gain International Trading Company Limited

Room D, 10/F, Tower A, Billion Centre,

1 Wang Kwong Road,
Kowloon Bay, Kowloon, Hong Kong

- [74] Law Wai Lun
Flat 601-602, Block 1, Yip On Factory Estate,
Wang Hoi Road,
Kowloon Bay, Kowloon, Hong Kong

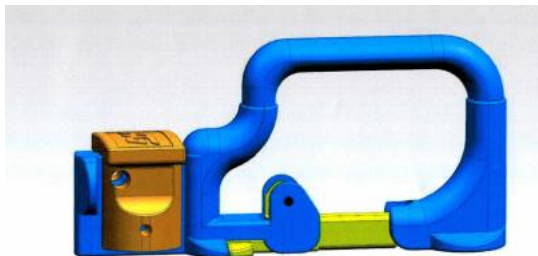

[11] 2016452.9

[15] 08-07-2020

[51] Cl. 11-01

[54] 吊墜
Pendant

[73] 齋色園
SIK SIK YUEN
香港九龍
黃大仙竹園村 2 號
齋色園黃大仙祠

[74] 劉國基
香港中環
都爹利街 6 號
印刷行 7 樓 701 室



[11] 2016453.1

- [15] 08-07-2020
[51] Cl. 11-03
[54] 金章
Gold badge
[73] 齋色園
SIK SIK YUEN
香港九龍
黃大仙竹園村 2 號
齋色園黃大仙祠
[74] 劉國基
香港中環
都爹利街 6 號
印刷行 7 樓 701 室



-
- [11] 2016454.3
[15] 08-07-2020
[51] Cl. 8-06
[54] 門不銹鋼把手
Stainless steel door handle
[73] 梁榮宗及蔡素君以雅楷設計（香港）之名營業
LEUNG WING CHUN AND CHOI SO KWAN TRADING AS ARCA FIRMA (HONG KONG)
香港沙田火炭
山尾街 31-35 號
華樂工業中心 D 座 1841 室
[74] ARCA FIRMA (HONG KONG)
香港沙田火炭
山尾街 31-35 號
華樂工業中心 D 座 1841 室



[11] 2016458.2M001

[15] 09-07-2020

[51] Cl. 11-01

[54] 飾物設計

Ornament design

[73] 六福集團有限公司

Luk Fook Holdings Company Limited
Floor 15, 20, 25 & 27, Metropole Square,
No.2 On Yiu Street,
Shatin, New Territories, Hong Kong

[74] Luk Fook Holdings Company Limited (Legal Affairs Department)

Floor 25, Metropole Square,
No.2 On Yiu Street,
Shatin, New Territories, Hong Kong



[11] 2016458.2M002

[15] 09-07-2020

[51] Cl. 11-01

[54] 飾物設計

Ornament design

[73] 六福集團有限公司

Luk Fook Holdings Company Limited

Floor 15, 20, 25 & 27, Metropole Square,

No.2 On Yiu Street,

Shatin, New Territories, Hong Kong

[74] Luk Fook Holdings Company Limited (Legal Affairs Department)

Floor 25, Metropole Square,

No.2 On Yiu Street,

Shatin, New Territories, Hong Kong



[11] 2016458.2M003

[15] 09-07-2020

[51] Cl. 11-01

[54] 飾物設計

Ornament design

[73] 六福集團有限公司

Luk Fook Holdings Company Limited

Floor 15, 20, 25 & 27, Metropole Square,

No.2 On Yiu Street,

Shatin, New Territories, Hong Kong

[74] Luk Fook Holdings Company Limited (Legal Affairs Department)

Floor 25, Metropole Square,

No.2 On Yiu Street,

Shatin, New Territories, Hong Kong



[11] 2016458.2M004

[15] 09-07-2020

[51] Cl. 11-01

[54] 飾物設計

Ornament design

[73] 六福集團有限公司

Luk Fook Holdings Company Limited
Floor 15, 20, 25 & 27, Metropole Square,
No.2 On Yiu Street,
Shatin, New Territories, Hong Kong

[74] Luk Fook Holdings Company Limited (Legal Affairs Department)

Floor 25, Metropole Square,
No.2 On Yiu Street,
Shatin, New Territories, Hong Kong



[11] 2016458.2M005

[15] 09-07-2020

[51] Cl. 11-01

[54] 飾物設計

Ornament design

[73] 六福集團有限公司

Luk Fook Holdings Company Limited
Floor 15, 20, 25 & 27, Metropole Square,
No.2 On Yiu Street,
Shatin, New Territories, Hong Kong

[74] Luk Fook Holdings Company Limited (Legal Affairs Department)

Floor 25, Metropole Square,
No.2 On Yiu Street,
Shatin, New Territories, Hong Kong



[11] 2016458.2M006

[15] 09-07-2020

[51] Cl. 11-01

[54] 飾物設計

Ornament design

[73] 六福集團有限公司

Luk Fook Holdings Company Limited
Floor 15, 20, 25 & 27, Metropole Square,
No.2 On Yiu Street,
Shatin, New Territories, Hong Kong

[74] Luk Fook Holdings Company Limited (Legal Affairs Department)

Floor 25, Metropole Square,
No.2 On Yiu Street,
Shatin, New Territories, Hong Kong



[11] 2016458.2M007

[15] 09-07-2020

[51] Cl. 11-01

[54] 飾物設計

Ornament design

[73] 六福集團有限公司

Luk Fook Holdings Company Limited

Floor 15, 20, 25 & 27, Metropole Square,

No.2 On Yiu Street,

Shatin, New Territories, Hong Kong

[74] Luk Fook Holdings Company Limited (Legal Affairs Department)

Floor 25, Metropole Square,

No.2 On Yiu Street,

Shatin, New Territories, Hong Kong



[11] 2016458.2M008

[15] 09-07-2020

[51] Cl. 11-01

[54] 飾物設計

Ornament design

[73] 六福集團有限公司

Luk Fook Holdings Company Limited

Floor 15, 20, 25 & 27, Metropole Square,

No.2 On Yiu Street,

Shatin, New Territories, Hong Kong

[74] Luk Fook Holdings Company Limited (Legal Affairs Department)

Floor 25, Metropole Square,

No.2 On Yiu Street,

Shatin, New Territories, Hong Kong



[11] 2016458.2M009

[15] 09-07-2020

[51] Cl. 11-01

[54] 飾物設計

Ornament design

[73] 六福集團有限公司

Luk Fook Holdings Company Limited

Floor 15, 20, 25 & 27, Metropole Square,

No.2 On Yiu Street,

Shatin, New Territories, Hong Kong

[74] Luk Fook Holdings Company Limited (Legal Affairs Department)

Floor 25, Metropole Square,

No.2 On Yiu Street,

Shatin, New Territories, Hong Kong



[11] 2016458.2M010

[15] 09-07-2020

[51] Cl. 11-01

[54] 飾物設計

Ornament design

[73] 六福集團有限公司

Luk Fook Holdings Company Limited
Floor 15, 20, 25 & 27, Metropole Square,
No.2 On Yiu Street,
Shatin, New Territories, Hong Kong

[74] Luk Fook Holdings Company Limited (Legal Affairs Department)

Floor 25, Metropole Square,
No.2 On Yiu Street,
Shatin, New Territories, Hong Kong



[11] 2016458.2M011

[15] 09-07-2020

[51] Cl. 11-01

[54] 飾物設計

Ornament design

[73] 六福集團有限公司

Luk Fook Holdings Company Limited

Floor 15, 20, 25 & 27, Metropole Square,

No.2 On Yiu Street,

Shatin, New Territories, Hong Kong

[74] Luk Fook Holdings Company Limited (Legal Affairs Department)

Floor 25, Metropole Square,

No.2 On Yiu Street,

Shatin, New Territories, Hong Kong



[11] 2016458.2M012

[15] 09-07-2020

[51] Cl. 11-01

[54] 飾物設計

Ornament design

[73] 六福集團有限公司

Luk Fook Holdings Company Limited

Floor 15, 20, 25 & 27, Metropole Square,

No.2 On Yiu Street,

Shatin, New Territories, Hong Kong

[74] Luk Fook Holdings Company Limited (Legal Affairs Department)

Floor 25, Metropole Square,

No.2 On Yiu Street,

Shatin, New Territories, Hong Kong



[11] 2016458.2M013

[15] 09-07-2020

[51] Cl. 11-01

[54] 飾物設計

Ornament design

[73] 六福集團有限公司

Luk Fook Holdings Company Limited
Floor 15, 20, 25 & 27, Metropole Square,
No.2 On Yiu Street,
Shatin, New Territories, Hong Kong

[74] Luk Fook Holdings Company Limited (Legal Affairs Department)

Floor 25, Metropole Square,
No.2 On Yiu Street,
Shatin, New Territories, Hong Kong



[11] 2016458.2M014

[15] 09-07-2020

[51] Cl. 11-01

[54] 飾物設計

Ornament design

[73] 六福集團有限公司

Luk Fook Holdings Company Limited

Floor 15, 20, 25 & 27, Metropole Square,

No.2 On Yiu Street,

Shatin, New Territories, Hong Kong

[74] Luk Fook Holdings Company Limited (Legal Affairs Department)

Floor 25, Metropole Square,

No.2 On Yiu Street,

Shatin, New Territories, Hong Kong



[11] 2016458.2M015

[15] 09-07-2020

[51] Cl. 11-01

[54] 飾物設計

Ornament design

[73] 六福集團有限公司

Luk Fook Holdings Company Limited

Floor 15, 20, 25 & 27, Metropole Square,

No.2 On Yiu Street,

Shatin, New Territories, Hong Kong

[74] Luk Fook Holdings Company Limited (Legal Affairs Department)

Floor 25, Metropole Square,

No.2 On Yiu Street,

Shatin, New Territories, Hong Kong



[11] 2016458.2M016

[15] 09-07-2020

[51] Cl. 11-01

[54] 飾物設計

Ornament design

[73] 六福集團有限公司

Luk Fook Holdings Company Limited
Floor 15, 20, 25 & 27, Metropole Square,
No.2 On Yiu Street,
Shatin, New Territories, Hong Kong

[74] Luk Fook Holdings Company Limited (Legal Affairs Department)

Floor 25, Metropole Square,
No.2 On Yiu Street,
Shatin, New Territories, Hong Kong



[11] 2016458.2M017

[15] 09-07-2020

[51] Cl. 11-01

[54] 飾物設計

Ornament design

[73] 六福集團有限公司

Luk Fook Holdings Company Limited

Floor 15, 20, 25 & 27, Metropole Square,

No.2 On Yiu Street,

Shatin, New Territories, Hong Kong

[74] Luk Fook Holdings Company Limited (Legal Affairs Department)

Floor 25, Metropole Square,

No.2 On Yiu Street,

Shatin, New Territories, Hong Kong



[11] 2016458.2M018

[15] 09-07-2020

[51] Cl. 11-01

[54] 飾物設計

Ornament design

[73] 六福集團有限公司

Luk Fook Holdings Company Limited

Floor 15, 20, 25 & 27, Metropole Square,

No.2 On Yiu Street,

Shatin, New Territories, Hong Kong

[74] Luk Fook Holdings Company Limited (Legal Affairs Department)

Floor 25, Metropole Square,

No.2 On Yiu Street,

Shatin, New Territories, Hong Kong



[11] 2016459.4M001

[15] 09-07-2020

[51] Cl. 20-02

[54] 展示裝置

Display device

[73] 六福集團有限公司

Luk Fook Holdings Company Limited

Flat 15, 20, 25 & 27, Metropole Square,

No.2 On Yiu Street,

Shatin, New Territories, Hong Kong

[74] Luk Fook Holdings Company Limited (Legal Affairs Department)

Floor 25, Metropole Square,

No.2 On Yiu Street,

Shatin, New Territories, Hong Kong



[11] 2016459.4M002

[15] 09-07-2020

[51] Cl. 20-02

[54] 展示裝置

Display device

[73] 六福集團有限公司

Luk Fook Holdings Company Limited
Flat 15, 20, 25 & 27, Metropole Square,
No.2 On Yiu Street,
Shatin, New Territories, Hong Kong

[74] Luk Fook Holdings Company Limited (Legal Affairs Department)

Floor 25, Metropole Square,
No.2 On Yiu Street,
Shatin, New Territories, Hong Kong



[11] 2016459.4M003

[15] 09-07-2020

[51] Cl. 20-02

[54] 展示裝置

Display device

[73] 六福集團有限公司

Luk Fook Holdings Company Limited
Flat 15, 20, 25 & 27, Metropole Square,
No.2 On Yiu Street,
Shatin, New Territories, Hong Kong

[74] Luk Fook Holdings Company Limited (Legal Affairs Department)

Floor 25, Metropole Square,
No.2 On Yiu Street,
Shatin, New Territories, Hong Kong



[11] 2016459.4M004

[15] 09-07-2020

[51] Cl. 20-02

[54] 展示裝置

Display device

[73] 六福集團有限公司

Luk Fook Holdings Company Limited

Flat 15, 20, 25 & 27, Metropole Square,

No.2 On Yiu Street,

Shatin, New Territories, Hong Kong

[74] Luk Fook Holdings Company Limited (Legal Affairs Department)

Floor 25, Metropole Square,

No.2 On Yiu Street,

Shatin, New Territories, Hong Kong



[11] 2016459.4M005

[15] 09-07-2020

[51] Cl. 20-02

[54] 展示裝置

Display device

[73] 六福集團有限公司

Luk Fook Holdings Company Limited

Flat 15, 20, 25 & 27, Metropole Square,

No.2 On Yiu Street,

Shatin, New Territories, Hong Kong

[74] Luk Fook Holdings Company Limited (Legal Affairs Department)

Floor 25, Metropole Square,

No.2 On Yiu Street,

Shatin, New Territories, Hong Kong



[11] 2016459.4M006

[15] 09-07-2020

[51] Cl. 20-02

[54] 展示裝置

Display device

[73] 六福集團有限公司

Luk Fook Holdings Company Limited

Flat 15, 20, 25 & 27, Metropole Square,

No.2 On Yiu Street,

Shatin, New Territories, Hong Kong

[74] Luk Fook Holdings Company Limited (Legal Affairs Department)

Floor 25, Metropole Square,

No.2 On Yiu Street,

Shatin, New Territories, Hong Kong



[11] 2016459.4M007

[15] 09-07-2020

[51] Cl. 20-02

[54] 展示裝置

Display device

[73] 六福集團有限公司

Luk Fook Holdings Company Limited
Flat 15, 20, 25 & 27, Metropole Square,
No.2 On Yiu Street,
Shatin, New Territories, Hong Kong

[74] Luk Fook Holdings Company Limited (Legal Affairs Department)

Floor 25, Metropole Square,
No.2 On Yiu Street,
Shatin, New Territories, Hong Kong



[11] 2016459.4M008

[15] 09-07-2020

[51] Cl. 20-02

[54] 展示裝置

Display device

[73] 六福集團有限公司

Luk Fook Holdings Company Limited
Flat 15, 20, 25 & 27, Metropole Square,
No.2 On Yiu Street,
Shatin, New Territories, Hong Kong

[74] Luk Fook Holdings Company Limited (Legal Affairs Department)

Floor 25, Metropole Square,
No.2 On Yiu Street,
Shatin, New Territories, Hong Kong



[11] 2016459.4M009

[15] 09-07-2020

[51] Cl. 20-02

[54] 展示裝置

Display device

[73] 六福集團有限公司

Luk Fook Holdings Company Limited

Flat 15, 20, 25 & 27, Metropole Square,

No.2 On Yiu Street,

Shatin, New Territories, Hong Kong

[74] Luk Fook Holdings Company Limited (Legal Affairs Department)

Floor 25, Metropole Square,

No.2 On Yiu Street,

Shatin, New Territories, Hong Kong



[11] 2016459.4M010

[15] 09-07-2020

[51] Cl. 20-02

[54] 展示裝置

Display device

[73] 六福集團有限公司

Luk Fook Holdings Company Limited
Flat 15, 20, 25 & 27, Metropole Square,
No.2 On Yiu Street,
Shatin, New Territories, Hong Kong

[74] Luk Fook Holdings Company Limited (Legal Affairs Department)

Floor 25, Metropole Square,
No.2 On Yiu Street,
Shatin, New Territories, Hong Kong



[11] 2016459.4M011

[15] 09-07-2020

[51] Cl. 20-03

[54] 店鋪招牌

Display device

[73] 六福集團有限公司

Luk Fook Holdings Company Limited
Flat 15, 20, 25 & 27, Metropole Square,
No.2 On Yiu Street,
Shatin, New Territories, Hong Kong

[74] Luk Fook Holdings Company Limited (Legal Affairs Department)

Floor 25, Metropole Square,
No.2 On Yiu Street,
Shatin, New Territories, Hong Kong

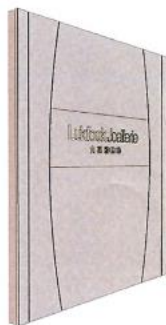

[11] 2016460.6M001

[15] 09-07-2020

[51] Cl. 11-01

[54] 飾物設計

Ornament design

[73] 六福集團有限公司

Luk Fook Holdings Company Limited
Floor 15, 20, 25 & 27, Metropole Square,
No.2 On Yiu Street,
Shatin, New Territories, Hong Kong

[74] Luk Fook Holdings Company Limited (Legal Affairs Department)

Floor 25, Metropole Square,
No.2 On Yiu Street,
Shatin, New Territories, Hong Kong



[11] 2016460.6M002

[15] 09-07-2020

[51] Cl. 11-01

[54] 飾物設計

Ornament design

[73] 六福集團有限公司

Luk Fook Holdings Company Limited
Floor 15, 20, 25 & 27, Metropole Square,
No.2 On Yiu Street,
Shatin, New Territories, Hong Kong

[74] Luk Fook Holdings Company Limited (Legal Affairs Department)

Floor 25, Metropole Square,
No.2 On Yiu Street,
Shatin, New Territories, Hong Kong



[11] 2016460.6M003

[15] 09-07-2020

[51] Cl. 11-01

[54] 飾物設計

Ornament design

[73] 六福集團有限公司

Luk Fook Holdings Company Limited

Floor 15, 20, 25 & 27, Metropole Square,

No.2 On Yiu Street,

Shatin, New Territories, Hong Kong

[74] Luk Fook Holdings Company Limited (Legal Affairs Department)

Floor 25, Metropole Square,

No.2 On Yiu Street,

Shatin, New Territories, Hong Kong



[11] 2016460.6M004

[15] 09-07-2020

[51] Cl. 11-01

[54] 飾物設計

Ornament design

[73] 六福集團有限公司

Luk Fook Holdings Company Limited
Floor 15, 20, 25 & 27, Metropole Square,
No.2 On Yiu Street,
Shatin, New Territories, Hong Kong

[74] Luk Fook Holdings Company Limited (Legal Affairs Department)

Floor 25, Metropole Square,
No.2 On Yiu Street,
Shatin, New Territories, Hong Kong



[11] 2016460.6M005

[15] 09-07-2020

[51] Cl. 11-01

[54] 飾物設計

Ornament design

[73] 六福集團有限公司

Luk Fook Holdings Company Limited
Floor 15, 20, 25 & 27, Metropole Square,
No.2 On Yiu Street,
Shatin, New Territories, Hong Kong

[74] Luk Fook Holdings Company Limited (Legal Affairs Department)

Floor 25, Metropole Square,
No.2 On Yiu Street,
Shatin, New Territories, Hong Kong



[11] 2016460.6M006

[15] 09-07-2020

[51] Cl. 11-01

[54] 飾物設計

Ornament design

[73] 六福集團有限公司

Luk Fook Holdings Company Limited

Floor 15, 20, 25 & 27, Metropole Square,

No.2 On Yiu Street,

Shatin, New Territories, Hong Kong

[74] Luk Fook Holdings Company Limited (Legal Affairs Department)

Floor 25, Metropole Square,

No.2 On Yiu Street,

Shatin, New Territories, Hong Kong



[11] 2016460.6M007

[15] 09-07-2020

[51] Cl. 11-01

[54] 飾物設計

Ornament design

[73] 六福集團有限公司

Luk Fook Holdings Company Limited
Floor 15, 20, 25 & 27, Metropole Square,
No.2 On Yiu Street,
Shatin, New Territories, Hong Kong

[74] Luk Fook Holdings Company Limited (Legal Affairs Department)

Floor 25, Metropole Square,
No.2 On Yiu Street,
Shatin, New Territories, Hong Kong



[11] 2016461.8M001

[15] 09-07-2020

[51] Cl. 11-01

[54] 飾物設計

Ornament design

[73] 六福集團有限公司

Luk Fook Holdings Company Limited
Floor 15, 20, 25 & 27, Metropole Square,
No.2 On Yiu Street,
Shatin, New Territories, Hong Kong

[74] Luk Fook Holdings Company Limited (Legal Affairs Department)

Floor 25, Metropole Square,
No.2 On Yiu Street,
Shatin, New Territories, Hong Kong



[11] 2016461.8M002

[15] 09-07-2020

[51] Cl. 11-01

[54] 飾物設計

Ornament design

[73] 六福集團有限公司

Luk Fook Holdings Company Limited
Floor 15, 20, 25 & 27, Metropole Square,
No.2 On Yiu Street,
Shatin, New Territories, Hong Kong

[74] Luk Fook Holdings Company Limited (Legal Affairs Department)

Floor 25, Metropole Square,
No.2 On Yiu Street,
Shatin, New Territories, Hong Kong



[11] 2016461.8M003

[15] 09-07-2020

[51] Cl. 11-01

[54] 飾物設計

Ornament design

[73] 六福集團有限公司

Luk Fook Holdings Company Limited

Floor 15, 20, 25 & 27, Metropole Square,
No.2 On Yiu Street,
Shatin, New Territories, Hong Kong

- [74] Luk Fook Holdings Company Limited (Legal Affairs Department)
Floor 25, Metropole Square,
No.2 On Yiu Street,
Shatin, New Territories, Hong Kong



[11] 2016461.8M004

[15] 09-07-2020

[51] Cl. 11-01

[54] 飾物設計
Ornament design

[73] 六福集團有限公司
Luk Fook Holdings Company Limited
Floor 15, 20, 25 & 27, Metropole Square,
No.2 On Yiu Street,
Shatin, New Territories, Hong Kong

[74] Luk Fook Holdings Company Limited (Legal Affairs Department)
Floor 25, Metropole Square,
No.2 On Yiu Street,
Shatin, New Territories, Hong Kong



[11] 2016461.8M005

[15] 09-07-2020

[51] Cl. 11-01

[54] 飾物設計

Ornament design

[73] 六福集團有限公司

Luk Fook Holdings Company Limited

Floor 15, 20, 25 & 27, Metropole Square,

No.2 On Yiu Street,

Shatin, New Territories, Hong Kong

[74] Luk Fook Holdings Company Limited (Legal Affairs Department)

Floor 25, Metropole Square,

No.2 On Yiu Street,

Shatin, New Territories, Hong Kong



[11] 2016461.8M006

[15] 09-07-2020

[51] Cl. 11-01

[54] 飾物設計

Ornament design

[73] 六福集團有限公司

Luk Fook Holdings Company Limited

Floor 15, 20, 25 & 27, Metropole Square,

No.2 On Yiu Street,

Shatin, New Territories, Hong Kong

[74] Luk Fook Holdings Company Limited (Legal Affairs Department)

Floor 25, Metropole Square,

No.2 On Yiu Street,

Shatin, New Territories, Hong Kong



[11] 2016461.8M007

[15] 09-07-2020

[51] Cl. 11-01

[54] 飾物設計

Ornament design

[73] 六福集團有限公司

Luk Fook Holdings Company Limited
Floor 15, 20, 25 & 27, Metropole Square,
No.2 On Yiu Street,
Shatin, New Territories, Hong Kong

[74] Luk Fook Holdings Company Limited (Legal Affairs Department)

Floor 25, Metropole Square,
No.2 On Yiu Street,
Shatin, New Territories, Hong Kong



[11] 2016461.8M008

[15] 09-07-2020

[51] Cl. 11-01

[54] 飾物設計

Ornament design

[73] 六福集團有限公司

Luk Fook Holdings Company Limited
Floor 15, 20, 25 & 27, Metropole Square,
No.2 On Yiu Street,
Shatin, New Territories, Hong Kong

[74] Luk Fook Holdings Company Limited (Legal Affairs Department)

Floor 25, Metropole Square,
No.2 On Yiu Street,
Shatin, New Territories, Hong Kong



[11] 2016461.8M009

[15] 09-07-2020

[51] Cl. 11-01

[54] 飾物設計

Ornament design

[73] 六福集團有限公司

Luk Fook Holdings Company Limited
Floor 15, 20, 25 & 27, Metropole Square,
No.2 On Yiu Street,
Shatin, New Territories, Hong Kong

[74] Luk Fook Holdings Company Limited (Legal Affairs Department)

Floor 25, Metropole Square,
No.2 On Yiu Street,
Shatin, New Territories, Hong Kong



[11] 2016462.0

[15] 09-07-2020

[51] Cl. 11-04

[54] 馬形玫瑰花擺設

Horse shaped flower decoration

[73] 徐滿霖以 ROSE BABY 22 之名營業

Factory Unit 15, 8/F Block B, Tak Lee Ind Ctr,

8 Tsing Yeung Circuit,

Tuen Mun, New Territories, Hong Kong

[74] TSUI MUN LAM

香港新界屯門

兆安苑

定志閣 7 樓 3 室



- [11] 2016463.2
[15] 09-07-2020
[30] 27-02-2020 / JP / 003739 of 2020
[51] Cl. 2-02
[54] 人物戲服
Character costume
[73] 久光製藥株式會社
HISAMITSU PHARMACEUTICAL CO., INC.
408, Tashirodaikan-machi,
Tosu-shi, Saga 841-0017,
Japan
[74] WILKINSON & GRIST
6th Floor, Prince's Building,
Chater Road,
Hong Kong



-
- [11] 2016464.4M001
[15] 09-07-2020
[51] Cl. 21-01
[54] 玩具恐龍
Toy dinosaur
[73] 銀輝號有限公司
SILVERLIT LIMITED
Room 1704, World Trade Centre,
280 Gloucester Road,
Causeway Bay, Hong Kong
[74] SILVERLIT LIMITED (銀輝號有限公司)
Room 1704, World Trade Centre,
280 Gloucester Road,
Causeway Bay, Hong Kong



[11] 2016464.4M002

[15] 09-07-2020

[51] Cl. 21-01

[54] 玩具恐龍

Toy dinosaur

[73] 銀輝號有限公司

SILVERLIT LIMITED

Room 1704, World Trade Centre,

280 Gloucester Road,

Causeway Bay, Hong Kong

[74] SILVERLIT LIMITED (銀輝號有限公司)

Room 1704, World Trade Centre,

280 Gloucester Road,

Causeway Bay, Hong Kong



[11] 2016464.4M003

[15] 09-07-2020

[51] Cl. 21-01

[54] 玩具恐龍

Toy dinosaur

[73] 銀輝號有限公司

SILVERLIT LIMITED

Room 1704, World Trade Centre,
280 Gloucester Road,
Causeway Bay, Hong Kong

[74] SILVERLIT LIMITED (銀輝號有限公司)

Room 1704, World Trade Centre,
280 Gloucester Road,
Causeway Bay, Hong Kong

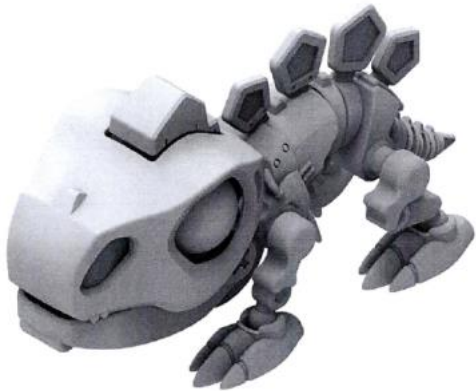

[11] 2016464.4M004

[15] 09-07-2020

[51] Cl. 21-01

[54] 玩具恐龍仔裝

Toy dinosaur twin set

[73] 銀輝號有限公司

SILVERLIT LIMITED

Room 1704, World Trade Centre,
280 Gloucester Road,
Causeway Bay, Hong Kong

[74] SILVERLIT LIMITED (銀輝號有限公司)

Room 1704, World Trade Centre,
280 Gloucester Road,
Causeway Bay, Hong Kong



[11] 2016464.4M005

[15] 09-07-2020

[51] Cl. 21-01

[54] 玩具恐龍

Toy dinosaur

[73] 銀輝號有限公司

SILVERLIT LIMITED

Room 1704, World Trade Centre,

280 Gloucester Road,

Causeway Bay, Hong Kong

[74] SILVERLIT LIMITED (銀輝號有限公司)

Room 1704, World Trade Centre,

280 Gloucester Road,

Causeway Bay, Hong Kong



[11] 2016464.4M006

[15] 09-07-2020

[51] Cl. 21-01

[54] 玩具恐龍

Toy dinosaur

[73] 銀輝號有限公司

SILVERLIT LIMITED

Room 1704, World Trade Centre,
280 Gloucester Road,
Causeway Bay, Hong Kong

[74] SILVERLIT LIMITED (銀輝號有限公司)

Room 1704, World Trade Centre,
280 Gloucester Road,
Causeway Bay, Hong Kong



[11] 2016465.7M001

[15] 09-07-2020

[30] 10-02-2020 / CA, AM, AZ, BZ, BA, GE, LI, MK, MD, MC, MN, ME,
MA, NO, OM, SG, CH, TN, TR, UA, GB, EU, AL, KG / DM/206 100

[51] Cl. 11-01

[54] 指環
Ring

[73] Harry Winston SA
Chemin du Tourbillon 8,
CH-1228 Plan-les-Ouates,
Switzerland

[74] SPRUSON & FERGUSON (HONG KONG) LIMITED
5001 Hopewell Centre,
183 Queen's Road East,
Wan Chai, Hong Kong



[11] 2016465.7M002

[15] 09-07-2020

[30] 10-02-2020 / CA, AM, AZ, BZ, BA, GE, LI, MK, MD, MC, MN, ME, MA, NO, OM, SG, CH, TN, TR, UA, GB, EU, AL, KG / DM/206 100

[51] Cl. 11-01

[54] 項鍊

Necklace

[73] Harry Winston SA

Chemin du Tourbillon 8,
CH-1228 Plan-les-Ouates,
Switzerland

[74] SPRUSON & FERGUSON (HONG KONG) LIMITED

5001 Hopewell Centre,
183 Queen's Road East,
Wan Chai, Hong Kong



[11] 2016465.7M003

[15] 09-07-2020

[30] 10-02-2020 / CA, AM, AZ, BZ, BA, GE, LI, MK, MD, MC, MN, ME, MA, NO, OM, SG, CH, TN, TR, UA, GB, EU, AL, KG / DM/206 100

[51] Cl. 11-01

[54] 指環

Ring

- [73] Harry Winston SA
Chemin du Tourbillon 8,
CH-1228 Plan-les-Ouates,
Switzerland
- [74] SPRUSON & FERGUSON (HONG KONG) LIMITED
5001 Hopewell Centre,
183 Queen's Road East,
Wan Chai, Hong Kong



-
- [11] 2016465.7M004
- [15] 09-07-2020
- [30] 10-02-2020 / CA, AM, AZ, BZ, BA, GE, LI, MK, MD, MC, MN, ME,
MA, NO, OM, SG, CH, TN, TR, UA, GB, EU, AL, KG / DM/206 100
- [51] Cl. 11-01
- [54] 耳環
Earring
- [73] Harry Winston SA
Chemin du Tourbillon 8,
CH-1228 Plan-les-Ouates,
Switzerland
- [74] SPRUSON & FERGUSON (HONG KONG) LIMITED
5001 Hopewell Centre,
183 Queen's Road East,
Wan Chai, Hong Kong



[11] 2016465.7M005

[15] 09-07-2020

[30] 10-02-2020 / CA, AM, AZ, BZ, BA, GE, LI, MK, MD, MC, MN, ME, MA, NO, OM, SG, CH, TN, TR, UA, GB, EU, AL, KG / DM/206 100

[51] Cl. 11-01

[54] 項鍊

Necklace

[73] Harry Winston SA

Chemin du Tourbillon 8,
CH-1228 Plan-les-Ouates,
Switzerland

[74] SPRUSON & FERGUSON (HONG KONG) LIMITED

5001 Hopewell Centre,
183 Queen's Road East,
Wan Chai, Hong Kong



[11] 2016465.7M006

[15] 09-07-2020

[30] 10-02-2020 / CA, AM, AZ, BZ, BA, GE, LI, MK, MD, MC, MN, ME, MA, NO, OM, SG, CH, TN, TR, UA, GB, EU, AL, KG / DM/206 100

[51] Cl. 11-01

[54] 項鍊

Necklace

[73] Harry Winston SA
Chemin du Tourbillon 8,
CH-1228 Plan-les-Ouates,
Switzerland

[74] SPRUSON & FERGUSON (HONG KONG) LIMITED
5001 Hopewell Centre,
183 Queen's Road East,
Wan Chai, Hong Kong



[11] 2016466.9

[15] 10-07-2020

[51] Cl. 25-01

[54] 建築材料
Building material

[73] 吳錦波
Jinbo WU
中國內地
廣東省惠來縣華湖鎮溪洋管區
文前三巷 10 之 1 號

[74] 中港知識產權有限公司
香港
港灣道 1 號會展廣場
辦公大樓 30 樓 3011 室

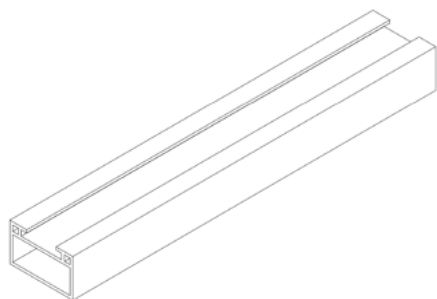

[11] 2016467.1

[15] 10-07-2020

[51] Cl. 25-01

[54] 建築材料
Building material

[73] 吳錦波
Jinbo WU
中國內地
廣東省惠來縣華湖鎮溪洋管區
文前三巷 10 之 1 號

[74] 中港知識產權有限公司
香港
港灣道 1 號會展廣場
辦公大樓 30 樓 3011 室

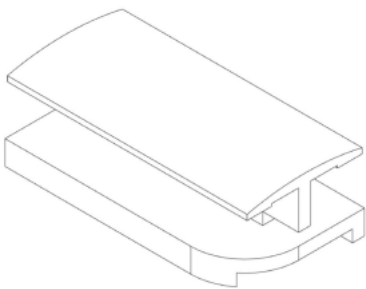

[11] 2016469.5

[15] 10-07-2020

[30] 19-06-2020 / MY / 20-E0362-0101

[51] Cl. 9-01

[54] 瓶子
Bottle

[73] CHUAN SIN SDN. BHD.
Lot 898, Jalan Reservoir,
Off Jalan Air Kuning,
34000 Taiping, Perak, Malaysia

[74] KAIZEN IP AGENT LIMITED
Rooms 2103, Futura Plaza,
111 How Ming Street,
Kwun Tong, Hong Kong

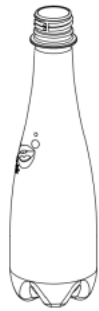

[11] 2016471.9M001

[15] 10-07-2020

[30] 06-03-2020 / SG, CH, GB, EU / WIPO92579

[51] Cl. 10-02

[54] 錶

Watch

[73] RICHEMONT INTERNATIONAL SA

Route des Biches 10,
1752 Villars-sur-Glâne,
Switzerland

[74] CHLOE LEE & CO.

1104 Tai Tung Building,
8 Fleming Road,
Wanchai, Hong Kong



[11] 2016471.9M002

[15] 10-07-2020

[30] 06-03-2020 / SG, CH, GB, EU / WIPO92579

[51] Cl. 10-07

[54] 錶殼連外框和錶盤

Watch case with bezel and dial

[73] RICHEMONT INTERNATIONAL SA
Route des Biches 10,
1752 Villars-sur-Glâne,
Switzerland

[74] CHLOE LEE & CO.
1104 Tai Tung Building,
8 Fleming Road,
Wanchai, Hong Kong



[11] 2016472.1M001

[15] 10-07-2020

[51] Cl. 23-04

[54] 便攜式香薰機

Portable aroma diffuser

[73] 璞真生活有限公司

PUZHEN LIFE CO., LTD

Unit 1112-1116, 11/F, Delta House,

3 On Yiu Street,

Shatin, Hong Kong

[74] FEDERATION OF HONG KONG INDUSTRIES

31/F, Billion Plaza,

8 Cheung Yue Street,

Cheung Sha Wan, Kowloon, Hong Kong

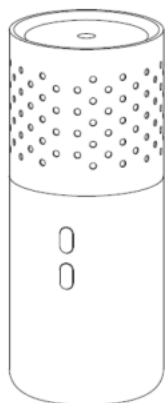

[11] 2016472.1M002

[15] 10-07-2020

[51] Cl. 23-04

[54] 便攜式香薰機

Portable aroma diffuser

[73] 璞真生活有限公司

PUZHEN LIFE CO., LTD

Unit 1112-1116, 11/F, Delta House,

3 On Yiu Street,

Shatin, Hong Kong

[74] FEDERATION OF HONG KONG INDUSTRIES

31/F, Billion Plaza,

8 Cheung Yue Street,

Cheung Sha Wan, Kowloon, Hong Kong

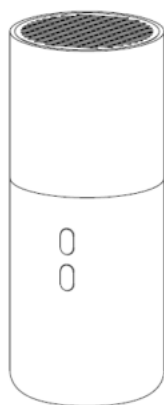

[11] 2016472.1M003

[15] 10-07-2020

[51] Cl. 23-04

[54] 便攜式香薰機

Portable aroma diffuser

[73] 璞真生活有限公司

PUZHEN LIFE CO., LTD

Unit 1112-1116, 11/F, Delta House,

3 On Yiu Street,

Shatin, Hong Kong

[74] FEDERATION OF HONG KONG INDUSTRIES

31/F, Billion Plaza,

8 Cheung Yue Street,

Cheung Sha Wan, Kowloon, Hong Kong

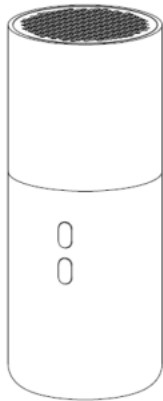

[11] 2016472.1M004

[15] 10-07-2020

[51] Cl. 23-04

[54] 便攜式香薰機

Portable aroma diffuser

[73] 璞真生活有限公司

PUZHEN LIFE CO., LTD

Unit 1112-1116, 11/F, Delta House,

3 On Yiu Street,

Shatin, Hong Kong

[74] FEDERATION OF HONG KONG INDUSTRIES

31/F, Billion Plaza,

8 Cheung Yue Street,

Cheung Sha Wan, Kowloon, Hong Kong

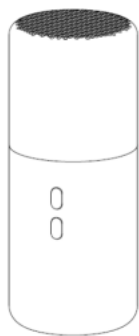



香港特別行政區政府知識產權署外觀設計註冊處

The Government of the Hong Kong Special Administrative Region

Designs Registry, Intellectual Property Department

根據註冊外觀設計條例第 28 條，下列註冊外觀設計因未繳續期費而停止有效。

各組記項按註冊外觀設計停止有效日期及註冊編號先後次序排列。

Registered designs ceased through non-payment of renewal fees under section 28 of the Registered Designs Ordinance. Entries are listed below under their expiry dates.

06-08-2020 - 10-08-2020

06-08-2020	1501774.8M002
1501749.6	1501775.1
1501750.8	1501776.3
	1501777.5
07-08-2020	1501778.7
0011053.4	

08-08-2020

0501840.7M001
0501840.7M002
0501840.7M003
0600664.3M001
0600664.3M002
1001448.2
1001450.6
1501754.6M001
1501754.6M002
1501754.6M003

09-08-2020

1001455.7M001
1001455.7M002
1001455.7M003
1001456.9
1001457.1
1501759.7
1501760.9
1501761.1
1501763.5M003
1501763.5M004

10-08-2020

0501862.3M003
1501774.8M001



香港特別行政區政府知識產權署外觀設計註冊處

The Government of the Hong Kong Special Administrative Region

Designs Registry, Intellectual Property Department

根據註冊外觀設計規則第 31 條刪除的註冊外觀設計。各組記項按註冊外觀設計刪除日期及註冊編號先後次序排列。

Registered designs removed under section 31 of the Registered Designs Rules. Entries are listed below under their removal dates.

25-09-2020 - 29-09-2020

25-09-2020	1000267.7M014
0500277.1M002	1000268.9
0500277.1M003	1000269.1M001
0500277.1M004	1000269.1M002
0500277.1M005	1000269.1M003
0500277.1M006	1000269.1M004
0500278.3	1500348.4
	1500349.6

26-09-2020

0010163.6M001
0500285.8
0500301.3M001
1000257.6

29-09-2020

1000278.0
1500350.8
1500351.0
1500352.2
1500353.4
1500363.5
1500381.3
1500382.5
1500385.2
1500386.4

27-09-2020

1500212.6M001
1500212.6M002
1500341.9
1500342.1M001

28-09-2020

1000267.7M001
1000267.7M002
1000267.7M003
1000267.7M004
1000267.7M005
1000267.7M006
1000267.7M007
1000267.7M008
1000267.7M009
1000267.7M010
1000267.7M011
1000267.7M012
1000267.7M013



香港特別行政區政府知識產權署外觀設計註冊處

The Government of the Hong Kong Special Administrative Region

Designs Registry, Intellectual Property Department

根據註冊外觀設計條例第 76 條，更正已提交文件中的錯誤

Correction of errors in filed documents under section 76 of the Registered Designs Ordinance

任何人士現可對下列更正錯誤的請求提出反對

Request for correction of errors now open to opposition

如任何人士意欲反對下列請求，則須在本官方公報刊登是項更正請求的日期起計的兩個月內，根據註冊外觀設計規則第62(4)條，採用指明外觀設計表格第D9號提交反對通知。如在限期內沒有收到任何反對通知，處長將依本公報刊登的更正請求的內容，准許是項更正請求。

If any person wishes to oppose the following request, he shall file a notice of opposition in specified Designs Form D9 within two months from the date of advertisement in this official journal under section 62(4) of the Registered Designs Rules. If no notice of opposition is received, the request for correction will be allowed by the Registrar in the present advertised form.

請求更正外觀設計表格第D1號第03部分中申請人的姓名或名稱

Request made for correction of applicant's name in Part 03 of the Designs Form D1 filed

[21] 2016559.7M001

[71] Lamb Weston, Inc.

[21] 2016559.7M002

[71] Lamb Weston, Inc.

[21] 2016559.7M003

[71] Lamb Weston, Inc.