

# 香港知識產權公報

Hong Kong Intellectual Property Journal

2020 年 1 月 17 日

17 January 2020



## 目錄 Contents

**根據註冊外觀設計條例第 25 條註冊的外觀設計**

**Designs Registered under section 25 of the Registered Designs Ordinance**

[按註冊編號排列](#)

[Arranged by Registration Number](#)

**根據註冊外觀設計條例(第 522 章)公布的其他公告**

**Other Notices Published under the Registered Designs Ordinance (Cap. 522)**

[根據註冊外觀設計條例第 28 條，註冊外觀設計因未繳續期費而停止有效](#)

[Registered designs ceased through non-payment of renewal fees under section 28 of the Registered Designs Ordinance](#)

[根據註冊外觀設計規則第 31 條刪除的註冊外觀設計](#)

[Registered designs removed under section 31 of the Registered Designs Rules](#)

**以下事項沒有記錄**

**No Records for the Following Matters**

[根據註冊外觀設計條例第 30 條放棄的外觀設計的註冊](#)

[Surrender of Registration of Design under section 30 of the Registered Designs Ordinance](#)

[根據註冊外觀設計規則第 37 條，向處長作出轉介](#)

[Reference to Registrar under section 37 of the Registered Designs Rules](#)

[根據註冊外觀設計條例第 45 條，撤銷註冊](#)

[Revocation of Registration under section 45 of the Registered Designs Ordinance](#)

[根據註冊外觀設計規則第 46 條，向法院作出轉介](#)

[Reference to Court under section 46 of the Registered Designs Rules](#)

根據註冊外觀設計規則第 63 條對不符合規定之處作出糾正  
Rectification of Irregularities under section 63 of the Registered Designs Rules

根據註冊外觀設計條例第 66 條，糾正註冊紀錄冊  
Rectification of Register under section 66 of the Registered Designs Ordinance

根據註冊外觀設計條例第 67 條，更正註冊紀錄冊內的錯誤  
Correction of Errors in Register under section 67 of the Registered Designs Ordinance

根據註冊外觀設計條例第 67 及 76 條，更正註冊紀錄冊內及已提交文件中的錯誤  
Correction of Errors in Register and in Filed Documents under sections  
67 and 76 of the Registered Designs Ordinance

根據註冊外觀設計條例第 76 條，更正已提交文件中的錯誤  
Correction of Errors in Filed Documents under section 76 of the Registered Designs  
Ordinance

勘誤  
Corrigendum

## 註冊外觀設計公告註釋

### Notes on advertisements of registration of designs

方括號表示下列資料：

Square brackets indicate the following data：

- [11] 註冊編號 Registration number / 聯合王國註冊編號 United Kingdom registration number
- [15] 註冊日期 Registration date / 當作註冊日期 Deemed registration date / 聯合王國註冊日期 United Kingdom registration date
- [17] 註冊有效期屆滿日期 Expiry date of the period of registration
- [22] 提交日期 Filing date / 當作提交日期 Deemed filing date / 聯合王國提交日期 United Kingdom filing date
- [30] 聲稱享有的優先權 (提交日期 / 巴黎公約國或世界貿易組織成員 / 申請編號) Priority claimed (filing date / Paris Convention country or WTO member / application number)
- [51] 國際外觀設計分類號 (洛迦諾分類號) International Classification of designs (Locarno Classification)
- [54] 物品 Article
- [55] 外觀設計的表述 Representation of the design
- [62] 分開前的申請編號及提交日期 Application number before division and filing date
- [66] 過往註冊的聯繫外觀設計註冊編號 / 日期 Registration No. / Date of Previous Registration for Association
- [72] 設計人 Designer

[73] 擁有人姓名和地址 Name and address of the owner

[74] 代理人 Agent /送達地址 Address for service



香港特別行政區政府知識產權署外觀設計註冊處

The Government of the Hong Kong Special Administrative Region

Designs Registry, Intellectual Property Department

## 根據註冊外觀設計條例第25條註冊的外觀設計

### Designs registered under section 25 of the Registered Designs Ordinance

按註冊編號排列

Arranged by Registration Number

[11] 1601359.9

[15] 14-07-2016

[51] Cl. 9-03

[54] 包裝盒

Packaging

[73] ROOFTOP GROUP INTERNATIONAL PTE. LTD.

4 SHENTON WAY, #28-03,

SGX CENTRE II, 068807,

SINGAPORE

[74] Eagle IP Limited

Room 508-509, Global Gateway Tower,

63 Wing Hong Street, Lai Chi Kok,

HONG KONG



[11] 1601361.3

[15] 14-07-2016

[51] Cl. 9-03

[54] 包裝盒

Packaging box

[73] ROOFTOP GROUP INTERNATIONAL PTE. LTD.  
4 SHENTON WAY, #28-03,  
SGX CENTRE II, 068807,  
SINGAPORE

[74] Eagle IP Limited  
Room 508-509, Global Gateway Tower,  
63 Wing Hong Street, Lai Chi Kok,  
HONG KONG



---

[11] 1601362.5

[15] 14-07-2016

[51] Cl. 9-03

[54] 包裝盒

Packaging box

[73] ROOFTOP GROUP INTERNATIONAL PTE. LTD.  
4 SHENTON WAY, #28-03,  
SGX CENTRE II, 068807,  
SINGAPORE

[74] Eagle IP Limited  
Room 508-509, Global Gateway Tower,  
63 Wing Hong Street, Lai Chi Kok,  
HONG KONG



---

[11] 1601363.7

[15] 14-07-2016

[51] Cl. 9-03

[54] 包裝盒

Packaging

[73] ROOFTOP GROUP INTERNATIONAL PTE. LTD.

4 SHENTON WAY, #28-03,

SGX CENTRE II, 068807,

SINGAPORE

[74] Eagle IP Limited

Room 508-509, Global Gateway Tower,

63 Wing Hong Street, Lai Chi Kok,

HONG KONG



---

[11] 1801654.7



- [15] 13-08-2018
- [30] 13-02-2018 / JP / 002828 of 2018
- [51] Cl. 28-03
- [54] 毛髮用染色工具  
Coloring tool for hair
- [73] Kao Kabushiki Kaisha (Kao Corporation)  
14-10, Nihonbashi Kayabacho 1-chome,  
Chuo-ku, Tokyo 103-8210, Japan
- [74] Oriental Intellectual Property Services Co.  
Flat B, 38F, South Tower 3,  
Phase 2, Residence Bel-Air,  
Island South, Hong Kong

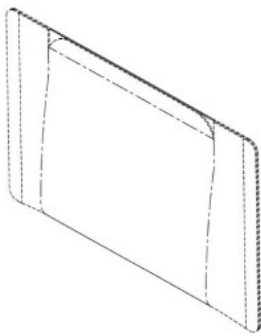

- 
- [11] 1913662.9
- [15] 17-05-2019
- [51] Cl. 9-03
- [54] 包裝盒  
Packaging box
- [73] 鴻運貿易(國際)有限公司  
HUNG WIN TRADING COMPANY LIMITED  
香港  
葵涌打磚坪街 44-52 號  
達明工業大廈 5 樓, A, A2, A3, A4, A5 室
- [74] 鴻運貿易(國際)有限公司  
香港 葵涌  
打磚坪街 44-52 號  
達明工業大廈 5 字樓 A 座 A2-A5 室



[11] 1913680.7M001

[15] 20-05-2019

[30] 17-01-2019 / JP / 000795 of 2019

[51] Cl. 28-03

[54] 穴位按摩工具

Points pressing tool

[73] 花王株式會社

Kao Kabushiki Kaisha (Kao Corporation)

14-10, Nihonbashi Kayabacho 1-chome, Chuo-ku, Tokyo

JAPAN

[74] CHINAHONGKONG PATENT LIMITED

3012, 30/F, Office Tower,

Convention Plaza, 1 Harbour Road,

HONG KONG

HONG KONG

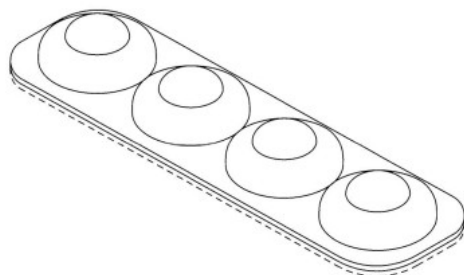

[11] 1913680.7M002

[15] 20-05-2019

[30] 17-01-2019 / JP / 000812 of 2019

[51] Cl. 28-03

[54] 穴位按摩工具

Points pressing tool

[73] 花王株式會社

Kao Kabushiki Kaisha (Kao Corporation)

14-10, Nihonbashi Kayabacho 1-chome, Chuo-ku, Tokyo

JAPAN

[74] CHINAHONGKONG PATENT LIMITED

3012, 30/F, Office Tower,

Convention Plaza, 1 Harbour Road,

HONG KONG

HONG KONG

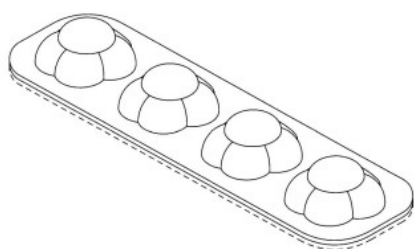

---

[11] 1913680.7M003

[15] 20-05-2019

[30] 17-01-2019 / JP / 000813 of 2019

[51] Cl. 28-03

[54] 穴位按摩工具

Points pressing tool

[73] 花王株式會社

Kao Kabushiki Kaisha (Kao Corporation)

14-10, Nihonbashi Kayabacho 1-chome, Chuo-ku, Tokyo

JAPAN

[74] CHINAHONGKONG PATENT LIMITED

3012, 30/F, Office Tower,

Convention Plaza, 1 Harbour Road,

HONG KONG

HONG KONG

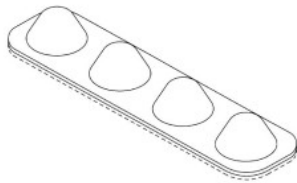

[11] 1913712.6

[15] 23-05-2019

[51] Cl. 9-03

[54] 包裝盒

Packaging box

[73] 德駿有限公司

Merit Smart Limited

Flat/Room A, 3rd Floor, Capital Commercial Building,  
No 448 Shanghai Street, Mongkok, Hong Kong.

[74] Bennett Chan & Co., Solicitors

Room 502, Yue Xiu Building,  
Nos.160-174 Lockhart Road, Wanchai,  
HONG KONG



[11] 1913812.8M001

[15] 03-06-2019

[30] 22-02-2019 / US / 29/681,197

[51] Cl. 4-02

[54] 電動牙刷頭

Motorized toothbrush head

[73] World Wide Daily Holdings Company Limited  
19/F., Koon Wah Mirror Factory,  
3rd Industrial Building, 5-9 Ka Hing Road,  
Kwai Chung, New Territories, HONG KONG

[74] MARKS & CLERK  
Level 9, Cyberport 1  
100 Cyberport Road, Pok Fu Lam  
HONG KONG

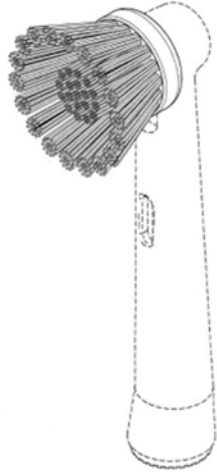

---

[11] 1913812.8M002

[15] 03-06-2019

[30] 22-02-2019 / US / 29/681,197

[51] Cl. 4-02

[54] 電動牙刷頭

Motorized toothbrush head

[73] World Wide Daily Holdings Company Limited  
19/F., Koon Wah Mirror Factory,  
3rd Industrial Building, 5-9 Ka Hing Road,  
Kwai Chung, New Territories, HONG KONG

[74] MARKS & CLERK  
Level 9, Cyberport 1  
100 Cyberport Road, Pok Fu Lam  
HONG KONG

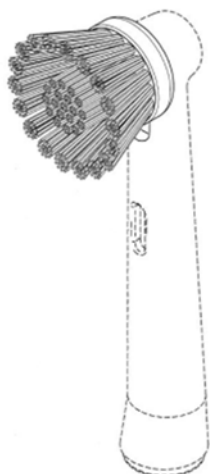

---

[11] 1913812.8M003

[15] 03-06-2019

[30] 22-02-2019 / US / 29/681,208

[51] Cl. 4-02

[54] 電動牙刷頭

Motorized toothbrush head

[73] World Wide Daily Holdings Company Limited  
19/F., Koon Wah Mirror Factory,  
3rd Industrial Building, 5-9 Ka Hing Road,  
Kwai Chung, New Territories, HONG KONG

[74] MARKS & CLERK  
Level 9, Cyberport 1  
100 Cyberport Road, Pok Fu Lam  
HONG KONG



[11] 1913812.8M004

[15] 03-06-2019

[30] 22-02-2019 / US / 29/681,227

[51] Cl. 4-02

[54] 電動牙刷頭

Motorized toothbrush head

[73] World Wide Daily Holdings Company Limited

19/F., Koon Wah Mirror Factory,

3rd Industrial Building, 5-9 Ka Hing Road,

Kwai Chung, New Territories, HONG KONG

[74] MARKS & CLERK

Level 9, Cyberport 1

100 Cyberport Road, Pok Fu Lam

HONG KONG



---

[11] 1913825.6

[15] 04-06-2019

[51] Cl. 9-01

[54] 水樽

Water Bottle

[73] DOP Limited

9th Floor, Amtel Building, 148 Des Voeux Rd Central,

Central

HONG KONG

[74] BENNY KONG & TSAI

Unit 19B, Overseas Trust Bank Building

No. 160 Gloucester Road, Wanchai

HONG KONG



---

[11] 1913840.7M001

[15] 05-06-2019

[51] Cl. 11-01

[54] 首飾

Jewellery

[73] De Beers UK Limited

20 Carlton House Terrace

London SW1Y 5AN

UNITED KINGDOM

[74] DEACONS

5th Floor, Alexandra House

Central

HONG KONG



---

[11] 1913840.7M002



[15] 05-06-2019

[51] Cl. 11-01

[54] 首飾

Jewellery

[73] De Beers UK Limited

20 Carlton House Terrace

London SW1Y 5AN

UNITED KINGDOM

[74] DEACONS

5th Floor, Alexandra House

Central

HONG KONG



---

[11] 1913950.0

[15] 12-06-2019

[30] 24-12-2018 / KR / 30-2018-0061244

[51] Cl. 27-99

[54] 電子煙芯體

Cartridge for electronic cigarette

[73] KT&G Corporation

71, Beotkkot-gil,

Daedeok-gu, Daejeon

KOREA, REPUBLIC OF

[74] Luo & Jia Intellectual Property Limited

9B, Cheong Tai Commercial Building,

66 Wing Lok Street, Sheung Wan,

HONG KONG

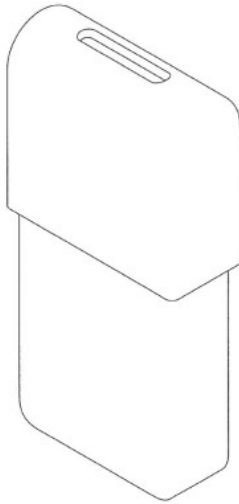

---

[11] 1913951.2

[15] 12-06-2019

[30] 24-12-2018 / KR / 30-2018-0061243

[51] Cl. 27-07

[54] 電子煙

Electronic cigarette

[73] KT&G Corporation

71, Beotkkot-gil,

Daedeok-gu, Daejeon

KOREA, REPUBLIC OF

[74] Luo & Jia Intellectual Property Limited

9B, Cheong Tai Commercial Building,

66 Wing Lok Street, Sheung Wan,

HONG KONG



- [11] 1914129.0  
[15] 04-07-2019  
[30] 05-01-2019 / CN / 201930005460.7  
[51] Cl. 13-02  
[54] 充電器  
Charger  
[73] 深圳市韶音科技有限公司 中  
國內地 廣東省深圳市寶安區  
石岩街道  
石新社區山城工業區 14#廠房 1 樓、4-6 樓  
[74] 百睿知識產權有限公司  
香港 新界沙田香港科  
學園  
科技大道西 10 號浚湖樓 617 室

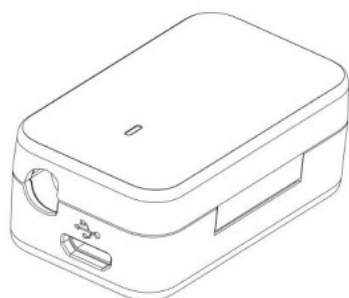

- 
- [11] 1914219.1M001  
[15] 15-07-2019  
[51] Cl. 3-01  
[54] 汽水樽收納籃  
Soft drink bottle storage basket  
[73] MORITO SCOVILL HK CO LTD.  
香港  
九龍觀塘海濱道 143 號  
中國航天科技中心 3 樓  
[74] MORITO SCOVILL HK CO LTD.  
香港  
九龍觀塘海濱道 143 號  
中國航天科技中心 3 樓



---

[11] 1914219.1M002

[15] 15-07-2019

[51] Cl. 3-01

[54] 汽水罐收納籃

Soft drink can storage basket

[73] MORITO SCOVILL HK CO LTD.

香港

九龍觀塘海濱道 143 號

中國航天科技中心 3 樓

[74] MORITO SCOVILL HK CO LTD.

香港

九龍觀塘海濱道 143 號

中國航天科技中心 3 樓



---

[11] 1914235.5M001

[15] 16-07-2019

[51] Cl. 21-01

[54] 玩具人

Toy figure

[73] 邱志崇

YAU CHI SUNG

香港新界將軍澳

調景嶺都會駅 2 座  
19 樓 C 室

[74] YAU CHI SUNG  
香港新界將軍澳  
調景嶺都會駅 2 座  
19 樓 C 室



---

[11] 1914235.5M002

[15] 16-07-2019

[51] Cl. 21-01

[54] 玩具人

Toy figure

[73] 邱志崇

YAU CHI SUNG  
香港新界將軍澳  
調景嶺都會駅 2 座  
19 樓 C 室

[74] YAU CHI SUNG  
香港新界將軍澳  
調景嶺都會駅 2 座  
19 樓 C 室



---

[11] 1914235.5M003

[15] 16-07-2019

[51] Cl. 21-01

[54] 玩具人

Toy figure

[73] 邱志崇

YAU CHI SUNG

香港新界將軍澳

調景嶺都會駅 2 座

19 樓 C 室

[74] YAU CHI SUNG

香港新界將軍澳

調景嶺都會駅 2 座

19 樓 C 室



---

[11] 1914235.5M004

[15] 16-07-2019

[51] Cl. 21-01

[54] 玩具人

Toy figure

[73] 邱志崇

YAU CHI SUNG

香港新界將軍澳

調景嶺都會駅 2 座

19 樓 C 室

[74] YAU CHI SUNG

香港新界將軍澳

調景嶺都會駅 2 座

19 樓 C 室



---

[11] 1914253.2

[15] 16-07-2019

[30] 17-01-2019 / EU / 006049508-0008

[51] Cl. 11-01

[54] 首飾

Jewellery

[73] LOUIS VUITTON MALLETIER

2 rue du Pont-Neuf

75001 Paris

FRANCE

[74] BAKER & MCKENZIE

14TH FLOOR, ONE TAIKOO PLACE,

979 KING'S ROAD, QUARRY BAY,

HONG KONG



---

[11] 1914267.2

[15] 17-07-2019

[30] 18-01-2019 / CA, EG, MC, MA, NO, RU, SG, CH, TN, TR, UA, GB,  
US, EU, JP, KR / DM/201332

[51] Cl. 3-01

[54] 手袋  
Handbag

[73] HERMES SELLIER  
24, rue du Faubourg Saint Honoré  
F-75008 PARIS  
FRANCE

[74] DEACONS  
5th Floor, Alexandra House  
Central  
HONG KONG



---

[11] 1914269.6

[15] 17-07-2019

[51] Cl. 19-04  
Cl. 19-08

[54] 印刷品封面  
Printed matter cover



[73] BESTIME INTERNATIONAL TRADING LIMITED  
FLAT 1, 22/F ASSUN PACIFIC CENTRE,  
NO. 41 TSUN YIP STREET, KWUN TONG, KOWLOON,  
HONG KONG

[74] IPMS CONSULTANTS LIMITED  
UNIT 2004B, 20/F, TOWER 5, CHINA HONG KONG CITY,  
33 CANTON ROAD, TSIM SHA TSUI, KOWLOON,  
HONG KONG



[11] 1914283.5M001

[15] 22-07-2019

[30] 03-04-2019 / DE / 402019100400.9

[51] C1. 12-08

[54] 汽車

Motor vehicle

[73] VOLKSWAGEN AKTIENGESELLSCHAFT  
38436 WOLFSBURG  
GERMANY

[74] CHINA PATENT AGENT (HONG KONG) LIMITED  
22/F, Great Eagle Centre, 23 Harbour Road, Wanchai  
HONG KONG



---

[11] 1914283.5M002

[15] 22-07-2019

[30] 03-04-2019 / DE / 402019100400.9

[51] Cl. 12-08

[54] 汽車

Motor vehicle

[73] VOLKSWAGEN AKTIENGESELLSCHAFT

38436 WOLFSBURG

GERMANY

[74] CHINA PATENT AGENT (HONG KONG) LIMITED

22/F, Great Eagle Centre, 23 Harbour Road, Wanchai

HONG KONG



---

[11] 1914283.5M003

[15] 22-07-2019

[30] 03-04-2019 / DE / 402019100400.9

[51] Cl. 12-08

[54] 汽車

Motor vehicle

[73] VOLKSWAGEN AKTIENGESELLSCHAFT

38436 WOLFSBURG

GERMANY

[74] CHINA PATENT AGENT (HONG KONG) LIMITED

22/F, Great Eagle Centre, 23 Harbour Road, Wanchai

HONG KONG



---

[11] 1914286.2M001

[15] 22-07-2019

[30] 29-05-2019 / LI / 2019-426

[51] Cl. 11-01

[54] 手鐲

Bracelet

[73] Swarovski Aktiengesellschaft

Dröschistrasse 15, 9495 Triesen,

LIECHTENSTEIN

[74] BAKER & MCKENZIE

14TH FLOOR, ONE TAIKOO PLACE,

979 KING'S ROAD, QUARRY BAY,

HONG KONG

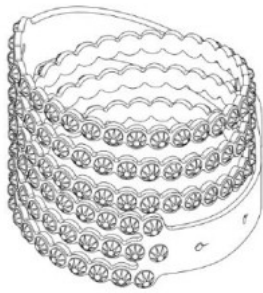

---

[11] 1914286.2M002

[15] 22-07-2019

[30] 29-05-2019 / LI / 2019-426

[51] Cl. 11-01

[54] 手鐲

Bracelet

[73] Swarovski Aktiengesellschaft  
Dröschistrasse 15, 9495 Triesen,  
LIECHTENSTEIN

[74] BAKER & MCKENZIE  
14TH FLOOR, ONE TAIKOO PLACE,  
979 KING'S ROAD, QUARRY BAY,  
HONG KONG

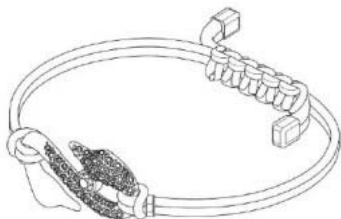

---

[11] 1914286.2M003

[15] 22-07-2019

[30] 29-05-2019 / LI / 2019-426

[51] Cl. 11-01

[54] 手鐲

Bracelet

[73] Swarovski Aktiengesellschaft  
Dröschistrasse 15, 9495 Triesen,  
LIECHTENSTEIN

[74] BAKER & MCKENZIE  
14TH FLOOR, ONE TAIKOO PLACE,  
979 KING'S ROAD, QUARRY BAY,  
HONG KONG

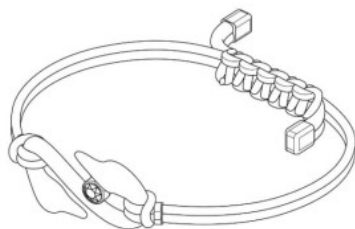

---

[11] 1914296.3

[15] 22-07-2019

[30] 22-02-2019 / WO / DM/201 002

[51] Cl. 11-01

[54] 吊墜

Pendant

[73] Harry Winston SA  
Chemin du Tourbillon 8, CH-1228 Plan-les-Ouates,  
SWITZERLAND

[74] SPRUSON & FERGUSON (HONG KONG) LIMITED  
5001 Hopewell Centre  
183 Queen's Road East, Wan Chai  
HONG KONG

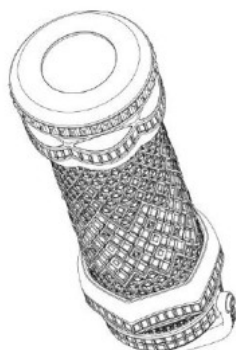

- [11] 1914298.7M001  
[15] 22-07-2019  
[30] 23-01-2019 / US / 29677788  
[51] Cl. 28-03  
[54] 化妝品或香水的陳列  
Cosmetic or fragrance display  
[73] CHANEL, INC  
9 West 57th Street New York  
NY 10019  
UNITED STATES  
[74] WILKINSON & GRIST  
6th Floor, Prince's Building  
Chater Road  
HONG KONG

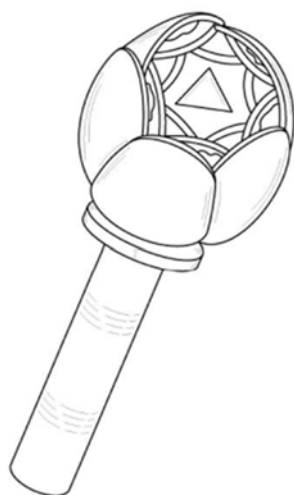

- 
- [11] 1914298.7M002  
[15] 22-07-2019  
[30] 23-01-2019 / US / 29677780  
[51] Cl. 28-03  
[54] 化妝品或香水的陳列  
Cosmetic or Fragrance Display  
[73] CHANEL, INC  
9 West 57th Street New York  
NY 10019  
UNITED STATES  
[74] WILKINSON & GRIST  
6th Floor, Prince's Building  
Chater Road  
HONG KONG

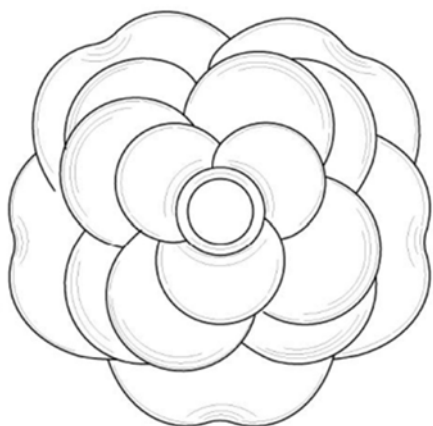

---

[11] 1914298.7M003

[15] 22-07-2019

[30] 23-01-2019 / US / 29677784

[51] Cl. 28-03

[54] 化妝品或香水的陳列

Cosmetic or Fragrance Display

[73] CHANEL, INC

9 West 57th Street New York

NY 10019

UNITED STATES

[74] WILKINSON & GRIST

6th Floor, Prince's Building

Chater Road

HONG KONG

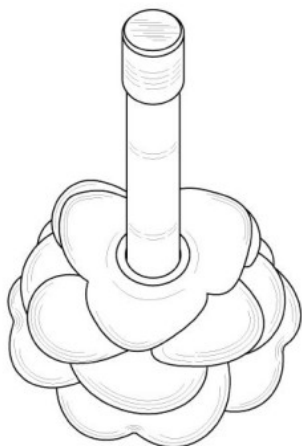

---

[11] 1914299.9

[15] 22-07-2019

[30] 24-01-2019 / CN / 201930041238.2

[51] Cl. 7-02

[54] 電飯煲

Electric cooker

[73] 北京小米移動軟件有限公司

BEIJING XIAOMI MOBILE SOFTWARE CO., LTD.

中國內地 北京市海澱區清河

中街 68 號

華潤五彩城購物中心二期 9 層 01 房間

[74] 香港派特恩知識產權代理有限公司

香港

上環永樂街 121-125 號

永達商業大廈 10 樓 C 室



---

[11] 1914300.3

[15] 23-07-2019

[30] 12-03-2019 / DE / 402019100292.8

[51] Cl. 21-01

[54] 玩具汽車

Toy vehicle

[73] VOLKSWAGEN AKTIENGESELLSCHAFT

38436 WOLFSBURG

GERMANY

[74] CHINA PATENT AGENT (HONG KONG) LIMITED

22/F, Great Eagle Centre, 23 Harbour Road, Wanchai

HONG KONG





---

[11] 1914301.5M001

[15] 23-07-2019

[30] 12-03-2019 / DE / 402019100292.8

[51] Cl. 12-08

[54] 汽車

Motor vehicle

[73] VOLKSWAGEN AKTIENGESELLSCHAFT

38436 WOLFSBURG

GERMANY

[74] CHINA PATENT AGENT (HONG KONG) LIMITED

22/F, Great Eagle Centre, 23 Harbour Road, Wanchai

HONG KONG



---

[11] 1914301.5M002

[15] 23-07-2019

[30] 12-03-2019 / DE / 402019100292.8

[51] Cl. 12-08

[54] 汽車

Motor vehicle

[73] VOLKSWAGEN AKTIENGESELLSCHAFT  
38436 WOLFSBURG  
GERMANY

[74] CHINA PATENT AGENT (HONG KONG) LIMITED  
22/F, Great Eagle Centre, 23 Harbour Road, Wanchai  
HONG KONG



---

[11] 1914301.5M003

[15] 23-07-2019

[30] 12-03-2019 / DE / 402019100292.8

[51] Cl. 12-08

[54] 汽車

Motor vehicle

[73] VOLKSWAGEN AKTIENGESELLSCHAFT  
38436 WOLFSBURG  
GERMANY

[74] CHINA PATENT AGENT (HONG KONG) LIMITED  
22/F, Great Eagle Centre, 23 Harbour Road, Wanchai  
HONG KONG



---

[11] 1914302.7M001

[15] 23-07-2019

[51] Cl. 11-01

[54] 吊咀

Pendent

[73] 嘉盈珠寶有限公司

Charming Jewellery Limited

RM 327, 3/F., BLOCK B, FOCAL INDUSTRIAL CENTRE, 21 MAN LOK  
STREET, HUNGHOM, KOWLOON  
HONG KONG

[74] CHINAHONGKONG IP LIMITED

3011, 30/F, Office Tower, Convention Plaza, 1 Harbour Road  
HONG KONG



---

[11] 1914302.7M002

[15] 23-07-2019

[51] Cl. 11-01

[54] 手鍊

Bracelet

[73] 嘉盈珠寶有限公司

Charming Jewellery Limited

RM 327, 3/F., BLOCK B, FOCAL INDUSTRIAL CENTRE, 21 MAN LOK  
STREET, HUNGHOM, KOWLOON  
HONG KONG

[74] CHINAHONGKONG IP LIMITED

3011, 30/F, Office Tower, Convention Plaza, 1 Harbour Road  
HONG KONG



---

[11] 1914302.7M003

[15] 23-07-2019

[51] Cl. 11-01

[54] 手鍊

Bracelet

[73] 嘉盈珠寶有限公司

Charming Jewellery Limited

RM 327, 3/F., BLOCK B, FOCAL INDUSTRIAL CENTRE, 21 MAN LOK  
STREET, HUNGHOM, KOWLOON  
HONG KONG

[74] CHINAHONGKONG IP LIMITED

3011, 30/F, Office Tower, Convention Plaza, 1 Harbour Road  
HONG KONG



---

[11] 1914302.7M004

[15] 23-07-2019

[51] Cl. 11-01

[54] 頸鍊

Necklace

[73] 嘉盈珠寶有限公司

Charming Jewellery Limited

RM 327, 3/F., BLOCK B, FOCAL INDUSTRIAL CENTRE, 21 MAN LOK  
STREET, HUNGHOM, KOWLOON  
HONG KONG

[74] CHINAHONGKONG IP LIMITED

3011, 30/F, Office Tower, Convention Plaza, 1 Harbour Road  
HONG KONG



---

[11] 1914302.7M005

[15] 23-07-2019

[51] Cl. 11-01

[54] 戒指

Ring

[73] 嘉盈珠寶有限公司

Charming Jewellery Limited

RM 327, 3/F., BLOCK B, FOCAL INDUSTRIAL CENTRE, 21 MAN LOK  
STREET, HUNGHOM, KOWLOON

HONG KONG

[74] CHINAHONGKONG IP LIMITED

3011, 30/F, Office Tower, Convention Plaza, 1 Harbour Road

HONG KONG



---

[11] 1914306.6

[15] 23-07-2019

[30] 25-01-2019 / JP / 2019 of 001398

[51] Cl. 9-01

[54] 瓶

BOTTLE

[73] Suntory Holdings Limited

2-1-40 Dojimahama

Kita-ku Osaka City, Osaka

JAPAN

[74] MARKS & CLERK

Level 9, Cyberport 1

100 Cyberport Road, Pok Fu Lam

HONG KONG

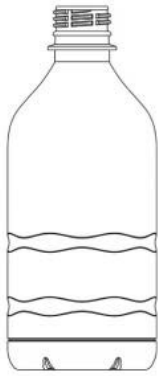

---

[11] 1914307.8M001

[15] 23-07-2019

[30] 28-02-2019 / AM, AZ, BZ, BA, GE, LI, MK, MD, MC, MN, ME, MA,  
NO, OM, SG, CH, TN, TR, UA, GB, EU, AL, KG / DM/200 704

[51] Cl. 10-02

[54] 手錶

Wristwatch

[73] THE SWATCH GROUP MANAGEMENT SERVICES AG (THE SWATCH GROUP  
MANAGEMENT SERVICES SA) (THE SWATCH GROUP MANAGEMENT SERVICES  
LTD.)

Seevorstadt 6, CH-2502 Biel/Bienne,  
SWITZERLAND

[74] SPRUSON & FERGUSON (HONG KONG) LIMITED

5001 Hopewell Centre

183 Queen's Road East, Wan Chai

HONG KONG



---

[11] 1914307.8M002

[15] 23-07-2019

[30] 28-02-2019 / AM, AZ, BZ, BA, GE, LI, MK, MD, MC, MN, ME, MA,  
NO, OM, SG, CH, TN, TR, UA, GB, EU, AL, KG / DM/200 704

[51] Cl. 10-02

[54] 手錶

Wristwatch

[73] THE SWATCH GROUP MANAGEMENT SERVICES AG (THE SWATCH GROUP  
MANAGEMENT SERVICES SA) (THE SWATCH GROUP MANAGEMENT SERVICES  
LTD.)

Seevorstadt 6, CH-2502 Biel/Bienne,  
SWITZERLAND

[74] SPRUSON & FERGUSON (HONG KONG) LIMITED

5001 Hopewell Centre  
183 Queen's Road East, Wan Chai  
HONG KONG



---

[11] 1914308.0M001

[15] 23-07-2019

[30] 23-01-2019 / EM / 006082137

[51] Cl. 24-01

[54] 熱療儀

Apparatus for thermotherapy

[73] Dermapharm AG

Lil-Dagover-Ring 7,  
82031 Grünwald,  
GERMANY

[74] CHINA PATENT AGENT (HONG KONG) LIMITED

22/F, Great Eagle Centre, 23 Harbour Road, Wanchai  
HONG KONG

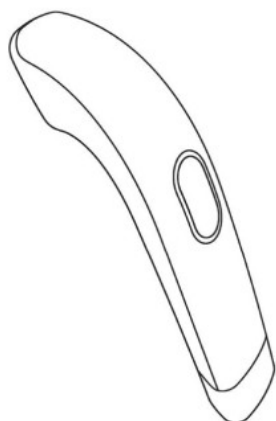

---

[11] 1914308.0M002

[15] 23-07-2019

[30] 23-01-2019 / EM / 006082137

[51] Cl. 24-01

[54] 熱療儀

Apparatus for thermotherapy

[73] Dermapharm AG

Lil-Dagover-Ring 7,

82031 Grünwald,

GERMANY

[74] CHINA PATENT AGENT (HONG KONG) LIMITED

22/F, Great Eagle Centre, 23 Harbour Road, Wanchai

HONG KONG

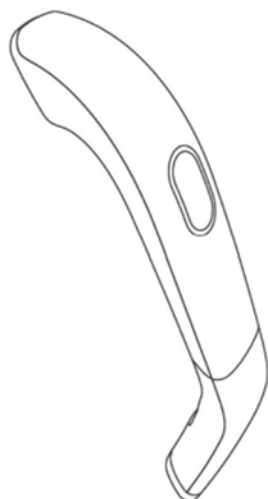

---

[11] 1914309.2



[15] 24-07-2019

[30] 03-04-2019 / DE / 402019100401.7

[51] Cl. 21-01

[54] 玩具汽車

Toy vehicle

[73] VOLKSWAGEN AKTIENGESELLSCHAFT

38436 WOLFSBURG

GERMANY

[74] CHINA PATENT AGENT (HONG KONG) LIMITED

22/F, Great Eagle Centre, 23 Harbour Road, Wanchai

HONG KONG



---

[11] 1914310.4M001

[15] 24-07-2019

[30] 03-04-2019 / DE / 402019100401.7

[51] Cl. 12-08

[54] 汽車

Motor vehicle

[73] VOLKSWAGEN AKTIENGESELLSCHAFT

38436 WOLFSBURG

GERMANY

[74] CHINA PATENT AGENT (HONG KONG) LIMITED

22/F, Great Eagle Centre, 23 Harbour Road, Wanchai

HONG KONG



[11] 1914310.4M002

[15] 24-07-2019

[30] 03-04-2019 / DE / 402019100401.7

[51] Cl. 12-08

[54] 汽車

Motor vehicle

[73] VOLKSWAGEN AKTIENGESELLSCHAFT

38436 WOLFSBURG

GERMANY

[74] CHINA PATENT AGENT (HONG KONG) LIMITED

22/F, Great Eagle Centre, 23 Harbour Road, Wanchai

HONG KONG



[11] 1914310.4M003

[15] 24-07-2019

[30] 03-04-2019 / DE / 402019100401.7

[51] Cl. 12-08

[54] 汽車

Motor vehicle

[73] VOLKSWAGEN AKTIENGESELLSCHAFT

38436 WOLFSBURG

GERMANY

[74] CHINA PATENT AGENT (HONG KONG) LIMITED

22/F, Great Eagle Centre, 23 Harbour Road, Wanchai

HONG KONG



---

[11] 1914311.6

[15] 24-07-2019

[30] 06-02-2019 / EM / 006179578

[51] Cl. 23-04

[54] 空氣淨化器

Air purifier

[73] Koninklijke Philips N.V.

High Tech Campus 5,

5656 AE Eindhoven

NETHERLANDS

[74] WILKINSON & GRIST

6th Floor, Prince's Building

Chater Road

HONG KONG

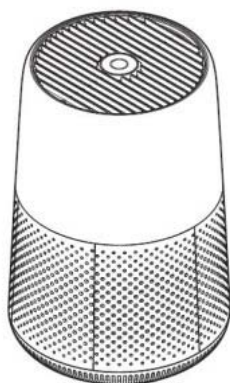

---

[11] 1914312.8

[15] 24-07-2019

[30] 27-02-2019 / EM / 006269775-0001

[51] Cl. 3-01

[54] 手提包

Handbag

[73] MOYNAT PARIS SAS

348, rue Saint Honoré

75001 PARIS

FRANCE

[74] WENPING & CO

1701 Tung Wai Commercial Building,

111 Gloucester Road,

HONG KONG



---

[11] 1914313.0M001

[15] 24-07-2019

[51] Cl. 27-06

[54] 香煙外觀包裝

Cigarette appearance packaging

[73] 香港見喜(集團)國際煙草有限公司

N/A

香港新界 沙田安

心街 19 號

匯貿中心 13 字樓 10 室

[74] 趙莊強

香港新界 沙田安

心街 19 號

匯貿中心 13 字樓 10 室



[11] 1914313.0M002

[15] 24-07-2019

[51] Cl. 27-06

[54] 香煙外觀包裝

Cigarette appearance packaging

[73] 香港見喜（集團）國際煙草有限公司

香港新界

沙田安心街 19 號

匯貿中心 13 字樓 10 室

[74] 趙莊強

香港新界 沙田安

心街 19 號

匯貿中心 13 字樓 10 室



[11] 1914314.2

[15] 24-07-2019

[51] Cl. 17-02

[54] 口琴琴格

Harmonica comb

[73] 劉天麟

LAU TIN LUN

香港 九龍石硤尾白田街

三十號

賽馬會創意藝術中心五樓廿二室

原美音感有限公司

Perfect Pitch Limited

香港 九龍石硤尾白田街三十

號

賽馬會創意藝術中心五樓廿二室

[74] 卓遠知識產權有限公司

香港

上環禧利街 27 號

富輝商業中心 10 樓

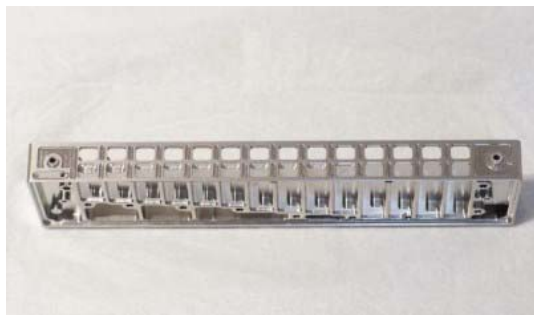

[11] 1914321.7

[15] 26-07-2019

[30] 01-07-2019 / EM / 006608642

[51] Cl. 9-09

[54] 腳踏式垃圾桶

Pedal bin

[73] Brabantia Nederland B.V.

De Haak 14,

5555 XK Valkenswaard,

NETHERLANDS

[74] NTD PATENT & TRADE MARK AGENCY LIMITED

Units 1805-6, 18/F., Greenfield Tower, Concordia Plaza,

No. 1 Science Museum Road, Tsimshatsui East, Kowloon,

HONG KONG

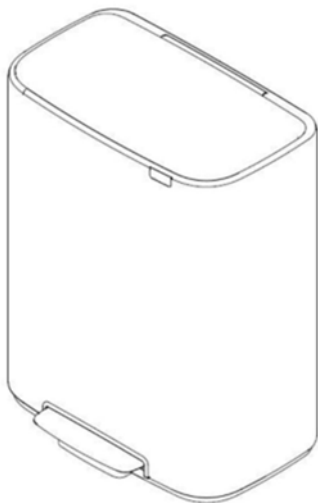

---

[11] 1914322.9M001

[15] 26-07-2019

[51] Cl. 28-03

[54] 粉撲

Powder puff

[73] Kabushikigaisha Shiseido (SHISEIDO Co., Ltd.)

5-5, Ginza 7-chome, Chuo-ku, Tokyo

JAPAN

[74] MARKS & CLERK

Level 9, Cyberport 1

100 Cyberport Road, Pok Fu Lam

HONG KONG



---

[11] 1914322.9M002

[15] 26-07-2019

[51] Cl. 28-03

[54] 粉撲

Powder puff

[73] Kabushikigaisha Shiseido (SHISEIDO Co., Ltd.)  
5-5, Ginza 7-chome, Chuo-ku, Tokyo  
JAPAN

[74] MARKS & CLERK  
Level 9, Cyberport 1  
100 Cyberport Road, Pok Fu Lam  
HONG KONG



---

[11] 1914324.3M001

[15] 26-07-2019

[30] 04-03-2019 / AM, AZ, BZ, BA, GE, LI, MK, MD, MC, MN, ME, MA,  
NO, OM, SG, CH, TN, TR, UA, GB, EU, AL, KG / DM/200 691

[51] Cl. 10-07

[54] 錶殼  
Watch case

[73] Harry Winston SA  
Chemin du Tourbillon 8, CH-1228 Plan-les-Ouates,  
SWITZERLAND

[74] SPRUSON & FERGUSON (HONG KONG) LIMITED  
5001 Hopewell Centre  
183 Queen's Road East, Wan Chai  
HONG KONG



---

[11] 1914324.3M002

[15] 26-07-2019



[30] 04-03-2019 / AM, AZ, BZ, BA, GE, LI, MK, MD, MC, MN, ME, MA,  
NO, OM, SG, CH, TN, TR, UA, GB, EU, AL, KG / DM/200 691

[51] Cl. 10-07

[54] 錶面  
Dial

[73] Harry Winston SA  
Chemin du Tourbillon 8, CH-1228 Plan-les-Ouates,  
SWITZERLAND

[74] SPRUSON & FERGUSON (HONG KONG) LIMITED  
5001 Hopewell Centre  
183 Queen's Road East, Wan Chai  
HONG KONG

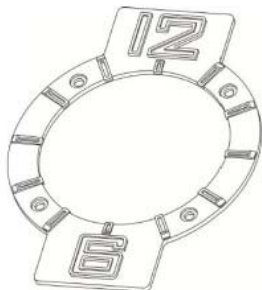

---

[11] 1914324.3M003

[15] 26-07-2019

[30] 04-03-2019 / AM, AZ, BZ, BA, GE, LI, MK, MD, MC, MN, ME, MA,  
NO, OM, SG, CH, TN, TR, UA, GB, EU, AL, KG / DM/200 691

[51] Cl. 10-07

[54] 錶面  
Dial

[73] Harry Winston SA  
Chemin du Tourbillon 8, CH-1228 Plan-les-Ouates,  
SWITZERLAND

[74] SPRUSON & FERGUSON (HONG KONG) LIMITED  
5001 Hopewell Centre  
183 Queen's Road East, Wan Chai  
HONG KONG



---

[11] 1914324.3M004

[15] 26-07-2019

[30] 04-03-2019 / AM, AZ, BZ, BA, GE, LI, MK, MD, MC, MN, ME, MA,  
NO, OM, SG, CH, TN, TR, UA, GB, EU, AL, KG / DM/200 691

[51] Cl. 10-07

[54] 錶面  
Dial

[73] Harry Winston SA  
Chemin du Tourbillon 8, CH-1228 Plan-les-Ouates,  
SWITZERLAND

[74] SPRUSON & FERGUSON (HONG KONG) LIMITED  
5001 Hopewell Centre  
183 Queen's Road East, Wan Chai  
HONG KONG

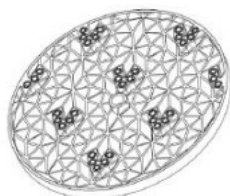

---

[11] 1914324.3M005

[15] 26-07-2019

[30] 04-03-2019 / AM, AZ, BZ, BA, GE, LI, MK, MD, MC, MN, ME, MA,  
NO, OM, SG, CH, TN, TR, UA, GB, EU, AL, KG / DM/200 691

[51] Cl. 10-07

[54] 錶面  
Dial

[73] Harry Winston SA  
Chemin du Tourbillon 8, CH-1228 Plan-les-Ouates,  
SWITZERLAND

[74] SPRUSON & FERGUSON (HONG KONG) LIMITED  
5001 Hopewell Centre  
183 Queen's Road East, Wan Chai  
HONG KONG

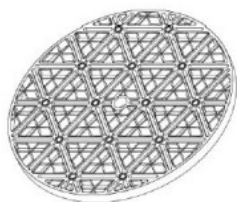

---

[11] 1914324.3M006

[15] 26-07-2019

[30] 04-03-2019 / AM, AZ, BZ, BA, GE, LI, MK, MD, MC, MN, ME, MA,  
NO, OM, SG, CH, TN, TR, UA, GB, EU, AL, KG / DM/200 691

[51] Cl. 10-07

[54] 錶面  
Dial

[73] Harry Winston SA  
Chemin du Tourbillon 8, CH-1228 Plan-les-Ouates,  
SWITZERLAND

[74] SPRUSON & FERGUSON (HONG KONG) LIMITED  
5001 Hopewell Centre  
183 Queen's Road East, Wan Chai  
HONG KONG

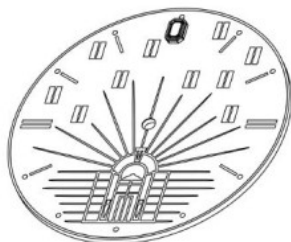

---

[11] 1914325.6

[15] 26-07-2019

[51] Cl. 13-02

[54] 移動電源

Mobile power [73]

皇者國際貿易有限公司

XPOWER INTERNATIONAL TRADING LIMITED

香港

葵興葵昌路 58-70 號 永

祥工業大廈 1 樓 A 室

[74] H&D LAW FIRM HK LIMITED

香港

中環皇后大道中 70 號

卡佛大廈 1104 室

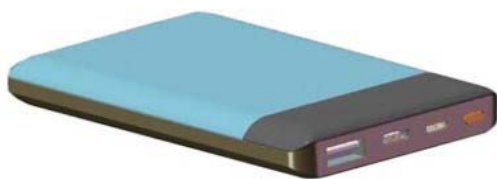

---

[11] 1914326.8M001

[15] 26-07-2019

[30] 15-03-2019 / CH / 144547

[51] Cl. 10-02

[54] 錶

Watch

[73] Montres Tudor SA

3, rue François-Dussaud

1211 Genève 26  
SWITZERLAND

[74] DEACONS  
5th Floor, Alexandra House  
Central  
HONG KONG



---

[11] 1914326.8M002

[15] 26-07-2019

[30] 15-03-2019 / CH / 144547

[51] Cl. 10-07

[54] 錶帶

Watch bracelet

[73] Montres Tudor SA  
3, rue François-Dussaud  
1211 Genève 26  
SWITZERLAND

[74] DEACONS  
5th Floor, Alexandra House  
Central  
HONG KONG

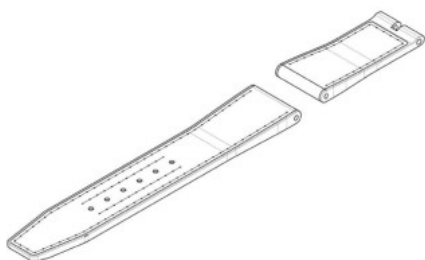

---

[11] 1914326.8M003

[15] 26-07-2019

[30] 15-03-2019 / CH / 144547

[51] Cl. 10-07

[54] 錶帶用的圖案  
Pattern for watch bracelet

[73] Montres Tudor SA  
3, rue François-Dussaud  
1211 Genève 26  
SWITZERLAND

[74] DEACONS  
5th Floor, Alexandra House  
Central  
HONG KONG

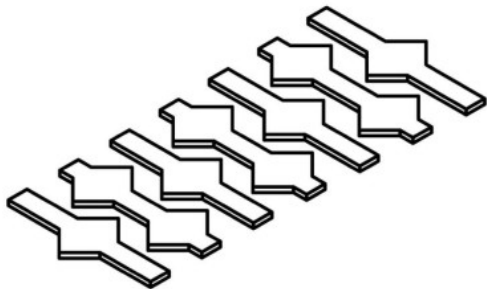

---

[11] 1914326.8M004

[15] 26-07-2019

[30] 15-03-2019 / CH / 144547

[51] Cl. 10-07

[54] 錶帶用的圖案  
Pattern for watch bracelet

[73] Montres Tudor SA  
3, rue François-Dussaud  
1211 Genève 26  
SWITZERLAND

[74] DEACONS  
5th Floor, Alexandra House  
Central  
HONG KONG

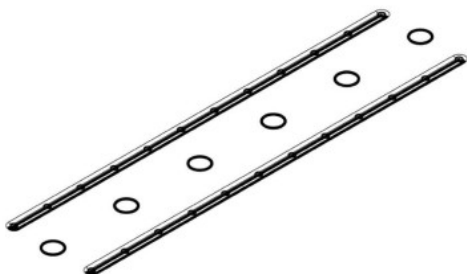

- [11] 1914328.2  
[15] 26-07-2019  
[30] 21-02-2019 / CA, FI, NO, RU, SG, CH, TR, UA, US, EU, JP, KR /  
DM/201 495  
[51] Cl. 15-02  
[54] 真空泵  
Vacuum pump  
[73] Busch Produktions GmbH  
Schauinslandstrasse 1  
79689 Maulburg  
GERMANY  
[74] WENPING & CO  
1701 Tung Wai Commercial Building,  
111 Gloucester Road,  
HONG KONG

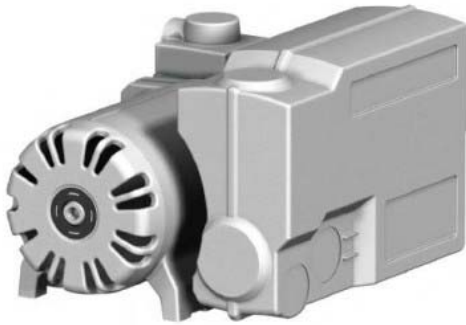

- 
- [11] 1914337.1M001  
[15] 30-07-2019  
[30] 06-03-2019 / AM, AZ, BZ, BA, GE, LI, MK, MD, MC, MN, ME, MA,  
NO, OM, SG, CH, TN, TR, UA, GB, EU, AL, KG / DM/200 695  
[51] Cl. 11-01  
[54] 項鍊  
Necklace  
[73] Harry Winston SA  
Chemin du Tourbillon 8, CH-1228 Plan-les-Ouates,  
SWITZERLAND  
[74] SPRUSON & FERGUSON (HONG KONG) LIMITED  
5001 Hopewell Centre  
183 Queen's Road East, Wan Chai  
HONG KONG



---

[11] 1914337.1M002

[15] 30-07-2019

[30] 06-03-2019 / AM, AZ, BZ, BA, GE, LI, MK, MD, MC, MN, ME, MA,  
NO, OM, SG, CH, TN, TR, UA, GB, EU, AL, KG / DM/200 695

[51] Cl. 11-01

[54] 項鍊

Necklace

[73] Harry Winston SA

Chemin du Tourbillon 8, CH-1228 Plan-les-Ouates,  
SWITZERLAND

[74] SPRUSON & FERGUSON (HONG KONG) LIMITED

5001 Hopewell Centre  
183 Queen's Road East, Wan Chai  
HONG KONG



---

[11] 1914337.1M003

[15] 30-07-2019



[30] 06-03-2019 / AM, AZ, BZ, BA, GE, LI, MK, MD, MC, MN, ME, MA,  
NO, OM, SG, CH, TN, TR, UA, GB, EU, AL, KG / DM/200 695

[51] Cl. 11-01

[54] 耳環  
Earring

[73] Harry Winston SA  
Chemin du Tourbillon 8, CH-1228 Plan-les-Ouates,  
SWITZERLAND

[74] SPRUSON & FERGUSON (HONG KONG) LIMITED  
5001 Hopewell Centre  
183 Queen's Road East, Wan Chai  
HONG KONG



---

[11] 1914339.5

[15] 30-07-2019

[30] 31-01-2019 / JP / 2019 of 001890

[51] Cl. 9-07

[54] 泵式分配器的主體  
Main body of pump dispenser

[73] 花王株式會社  
Kao Kabushiki Kaisha (Kao Corporation)  
14-10, Nihonbashi Kayabacho 1-chome, Chuoku,  
Tokyo  
JAPAN

[74] CHINAHONGKONG PATENT LIMITED  
3012, 30/F, Office Tower, Convention Plaza, 1 Harbour Road  
HONG KONG

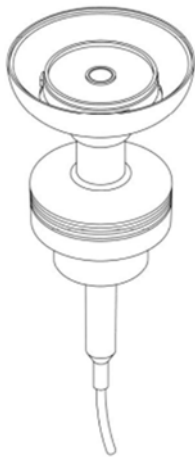

---

[11] 1914342.1

[15] 31-07-2019

[51] Cl. 9-01

[54] 樽

Bottle

[73] Shiseido Company, Limited  
5-5, Ginza 7-chome, Chuo-ku  
Tokyo 104-0061  
JAPAN

[74] MARKS & CLERK  
Level 9, Cyberport 1  
100 Cyberport Road, Pok Fu Lam  
HONG KONG



[11] 1914344.5M001

[15] 31-07-2019

[30] 31-01-2019 / EM / 006137576-0001

[51] Cl. 9-07

[54] 瓶蓋

Lid for bottle

[73] Bibo Brands

Torenplein 7.16.1, B-3500 Hasselt,  
BELGIUM

[74] NTD PATENT & TRADE MARK AGENCY LIMITED

Units 1805-6, 18/F., Greenfield Tower, Concordia Plaza, No. 1  
Science Museum Road, Tsimshatsui East, Kowloon,  
HONG KONG

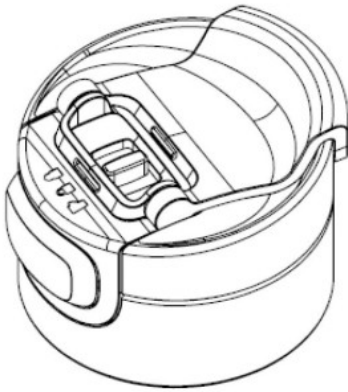

---

[11] 1914344.5M002

[15] 31-07-2019

[30] 31-01-2019 / EM / 006137576-0002

[51] Cl. 9-07

[54] 瓶蓋

Lid for bottle

[73] Bibo Brands

Torenplein 7.16.1, B-3500 Hasselt,  
BELGIUM

[74] NTD PATENT & TRADE MARK AGENCY LIMITED

Units 1805-6, 18/F., Greenfield Tower, Concordia Plaza, No. 1  
Science Museum Road, Tsimshatsui East, Kowloon,  
HONG KONG

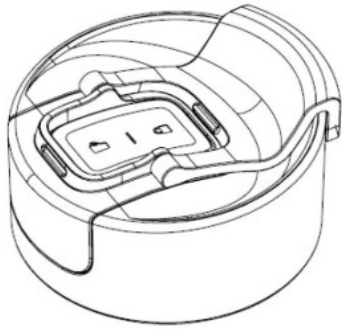

---

[11] 1914344.5M003

[15] 31-07-2019

[30] 31-01-2019 / EM / 006137576-0003

[51] Cl. 9-07

[54] 瓶蓋

Lid for bottle

[73] Bibo Brands

Torenplein 7.16.1, B-3500 Hasselt,  
BELGIUM

[74] NTD PATENT & TRADE MARK AGENCY LIMITED

Units 1805-6, 18/F., Greenfield Tower, Concordia Plaza, No. 1  
Science Museum Road, Tsimshatsui East, Kowloon,  
HONG KONG



---

[11] 1914345.8

[15] 31-07-2019

[51] Cl. 10-02

[54] 手錶

Watch

[73] 帕格尼尼(意大利)有限公司

Paganini Milano (Italy) S.R.L.

意大利

米蘭佛朗西斯科斯福爾扎街 15 號 20122

[74] 江炳滔律師事務所

香港

灣仔告士打道 160 號 海外信託銀

行大廈 19 樓 B 室

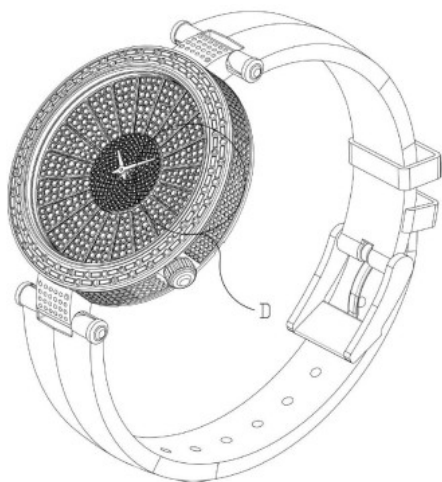

---

[11] 1914347.2

[15] 31-07-2019

[30] 31-01-2019 / AU / 201910498

[51] Cl. 9-07

[54] 用於液體容器的蓋

Cap for a liquid container

[73] Sea to Summit Pty Ltd

5 Eyre Street

Rivervale, Western Australia, 6103

AUSTRALIA

[74] BARRON & YOUNG INTELLECTUAL PROPERTY LIMITED

Suite 617, Lakeside 2

No. 10 Science Park West Avenue, Hong Kong Science Park,  
Shatin, N.T.

HONG KONG

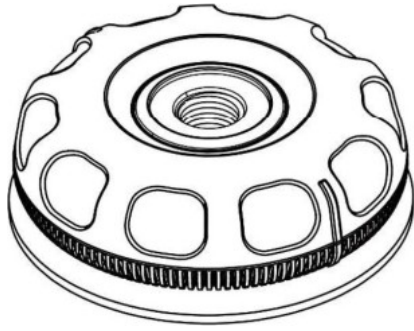



香港特別行政區政府知識產權署外觀設計註冊處

The Government of the Hong Kong Special Administrative Region

Designs Registry, Intellectual Property Department

根據註冊外觀設計條例第 28 條，下列註冊外觀設計因未繳續期費而停止有效。各組記項按註冊外觀設計停止有效日期及註冊編號先後次序排列。

**Registered designs ceased through non-payment of renewal fees under section 28 of the Registered Designs Ordinance. Entries are listed below under their expiry dates.**

**19-12-2019 - 25-12-2019**

<b>19-12-2019</b>	1501579.5M002	1402420.8M004
0412905.8M001	1501580.7	1402420.8M005
0412905.8M002		1402421.0

**22-12-2019**

<b>20-12-2019</b>	0412941.3	1402422.2
0902179.9	0412942.5	1402423.4M002
9911727.3	0412950.2	1402423.4M003
9911732.3	0412951.4	1402423.4M004
	0902194.0	1500219.1

**21-12-2019**

0902184.9M001	0902195.3	<b>24-12-2019</b>
0902184.9M002	0902199.1M001	0902208.2M001
0902184.9M003	0902199.1M002	0902208.2M002
0902184.9M004	0902200.5M001	
0902184.9M005	0902200.5M002	<b>25-12-2019</b>
0902184.9M006	0902200.5M003	1402424.6
0902189.0	1402396.6	1402425.9
1402274.7	1402398.0	
1402373.7M001	1402399.2	
1402373.7M002	1402400.6	
1402374.9	1402401.8	
1402376.4M001	1402402.0	
1402376.4M002	1402403.2	
1402378.8	1402404.4	

1402379.0

**23-12-2019**

1402380.2	0902201.7	
1402381.4	1402412.1	
1402384.0M001	1402413.3	
1402384.0M002	1402416.0	
1402387.7	1402417.2	
1402388.9	1402419.6M003	
1402390.3	1402420.8M001	
1402391.5	1402420.8M002	
1501579.5M001	1402420.8M003	



香港特別行政區政府知識產權署外觀設計註冊處

The Government of the Hong Kong Special Administrative Region

Designs Registry, Intellectual Property Department

根據註冊外觀設計規則第 31 條刪除的註冊外觀設計。各組記項按註冊外觀設計 刪除日期及註冊編號先後次序排列。

**Registered designs removed under section 31 of the Registered Designs Rules. Entries are listed below under their removal dates.**

**27-12-2019 - 02-01-2020**

<b>27-12-2019</b>	1401183.3M001
1401148.0	1401183.3M002
1401149.2M001	1401183.3M003
1401149.2M002	1401184.5
1401149.2M003	1401186.0
1401149.2M004	
1401149.2M005	
1401149.2M006	
1401154.2	
1401158.1M001	
1401158.1M002	
1401158.1M003	

**01-01-2020**

	0411402.9
	0901019.0
	0901020.2M021
	0901020.2M024
	0901020.2M027
	1401187.2M001
	1401187.2M002
	1401189.6
	1401190.8

**29-12-2019**

0901002.4  
0901004.8

**30-12-2019**

0901010.1M001  
0901010.1M002  
0901010.1M003  
0901010.1M004

**02-01-2020**

0901024.0  
1401194.6  
1401204.9  
9910780.3

**31-12-2019**

0411392.6M004  
0411392.6M006  
0411392.6M007  
0901018.8  
1401173.2  
1401174.4  
1401175.7  
1401176.9  
1401177.1  
1401182.1