

香港知識產權公報

Hong Kong Intellectual Property Journal

2019 年 5 月 17 日

17 May 2019

目錄

Contents

根據註冊外觀設計條例第25條註冊的外觀設計

Designs Registered under section 25 of the Registered Designs Ordinance

[按註冊編號排列](#)

[Arranged by Registration Number](#)

根據註冊外觀設計條例(第522章)公布的其他公告

**Other Notices Published under the Registered Designs Ordinance
(Cap. 522)**

[根據註冊外觀設計條例第28條, 註冊外觀設計因未繳續期費而停止有效](#)

[Registered designs ceased through non-payment of renewal fees under section 28 of the Registered Designs Ordinance](#)

[勘誤](#)

[Corrigendum](#)

以下事項沒有記錄

No Records for the Following Matters

[根據註冊外觀設計條例第30條放棄的外觀設計的註冊](#)

[Surrender of Registration of Design under section 30 of the Registered Designs Ordinance](#)

[根據註冊外觀設計規則第31條刪除的註冊外觀設計](#)

[Registered designs removed under section 31 of the Registered Designs Rules](#)

[根據註冊外觀設計規則第37條, 向處長作出轉介](#)

[Reference to Registrar under section 37 of the Registered Designs Rules](#)

[根據註冊外觀設計條例第45條, 撤銷註冊](#)

[Revocation of Registration under section 45 of the Registered Designs Ordinance](#)

根據註冊外觀設計規則第 46 條，向法院作出轉介
Reference to Court under section 46 of the Registered Designs Rules

根據註冊外觀設計規則第 63 條對不符合規定之處作出糾正
Rectification of Irregularities under section 63 of the Registered Designs Rules

根據註冊外觀設計條例第 66 條，糾正註冊紀錄冊
Rectification of Register under section 66 of the Registered Designs Ordinance

根據註冊外觀設計條例第 67 條，更正註冊紀錄冊內的錯誤
Correction of Errors in Register under section 67 of the Registered Designs Ordinance

根據註冊外觀設計條例第 67 及 76 條，更正註冊紀錄冊內及已提交文件中的錯誤
Correction of Errors in Register and in Filed Documents under sections 67 and 76 of the Registered Designs Ordinance

根據註冊外觀設計條例第 76 條，更正已提交文件中的錯誤
Correction of Errors in Filed Documents under section 76 of the Registered Designs Ordinance

註冊外觀設計公告註釋

Notes on advertisements of registration of designs

方括號表示下列資料：

Square brackets indicate the following data：

[11] 註冊編號 Registration number / 聯合王國註冊編號 United Kingdom registration number

[15] 註冊日期 Registration date / 當作註冊日期 Deemed registration date / 聯合王國註冊日期 United Kingdom registration date

[17] 註冊有效期屆滿日期 Expiry date of the period of registration

[22] 提交日期 Filing date / 當作提交日期 Deemed filing date / 聯合王國提交日期 United Kingdom filing date

[30] 聲稱享有的優先權 (提交日期 / 巴黎公約國或世界貿易組織成員 / 申請編號) Priority claimed (filing date / Paris Convention country or WTO member / application number)

[51] 國際外觀設計分類號 (洛迦諾分類號) International Classification of designs (Locarno Classification)

[54] 物品 Article

[55] 外觀設計的表述 Representation of the design

[62] 分開前的申請編號及提交日期 Application number before division and filing date

[66] 過往註冊的聯繫外觀設計註冊編號 / 日期 Registration No. / Date of Previous Registration for Association

[72] 設計人 Designer

[73] 擁有人姓名和地址 Name and address of the owner

[74] 代理人 Agent / 送達地址 Address for service



香港特別行政區政府知識產權署外觀設計註冊處

The Government of the Hong Kong Special Administrative Region

Designs Registry, Intellectual Property Department

根據註冊外觀設計條例第 25 條註冊的外觀設計

Designs registered under section 25 of the Registered Designs Ordinance

按註冊編號排列

Arranged by Registration Number

[11] 1700491.8

[15] 15-03-2017

[51] Cl. 14-02

[54] 頭戴式顯示設備

Head mounted display device

[73] 深圳市柔宇科技有限公司

中國內地廣東省深圳市 南山區科技
園科苑路 15 號 科興科 學園 A4-
1501

[74] 景福智慧顧問有限公司

香港銅鑼灣軒尼詩道 489 號
銅鑼灣廣場 1 期 22 樓 2202 室

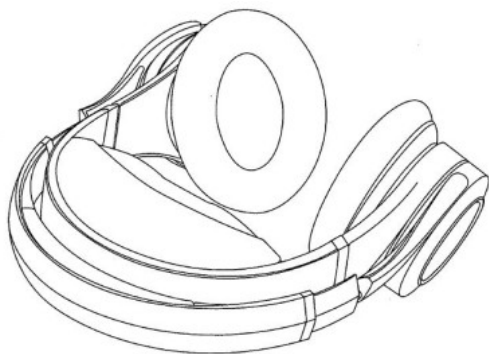

[11] 1700492.0

[15] 15-03-2017

[51] Cl. 14-02

[54] 多媒體處理終端

Multimedia processing terminal

[73] 深圳市柔宇科技有限公司

中國內地廣東省深圳市

南山區科技園科苑路 15 號 科興科
學園 A4-1501

- [74] 景福智慧顧問有限公司
香港銅鑼灣軒尼詩道 489 號
銅鑼灣廣場 1 期 22 樓 2202 室

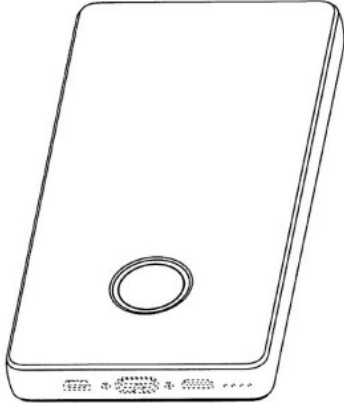

[11] 1700493.2

[15] 15-03-2017

[51] Cl. 14-02

[54] 頭戴式顯示設備

Head mounted display device

[73] 深圳市柔宇科技有限公司

中國內地廣東省深圳市 南山區科技
園科苑路 15 號 科興科 學園 A4-
1501

[74] 景福智慧顧問有限公司

香港銅鑼灣軒尼詩道 489 號
銅鑼灣廣場 1 期 22 樓 2202 室

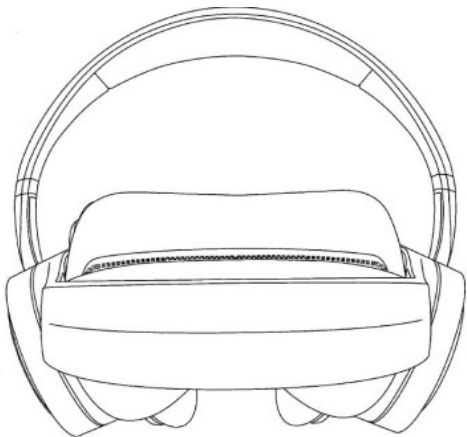

- [11] 1802020.4
[15] 09-10-2018
[30] 09-04-2018 / US / 29/643,417
[51] Cl. 7-01
[54] 容器蓋
Container lid
[73] Helen of Troy Limited
The Phoenix Centre,
George Street, Belleville,
St. Michael, BARBADOS
[74] Bird & Bird
4/F., Three Pacific Place,
1 Queen's Road East,
Hong Kong.



-
- [11] 1802021.6
[15] 09-10-2018
[30] 09-04-2018 / US / 29/643,411
[51] Cl. 7-01
[54] 容器蓋
Container lid
[73] Helen of Troy Limited
The Phoenix Centre,
George Street, Belleville,
St. Michael, BARBADOS
[74] Bird & Bird
4/F., Three Pacific Place,
1 Queen's Road East,
Hong Kong.



[11] 1802022.8

[15] 09-10-2018

[30] 09-04-2018 / US / 29/643,419

[51] Cl. 7-04

[54] 香料研磨器

Spice grinder

[73] Helen of Troy Limited

The Phoenix Centre,
George Street, Belleville,
St. Michael, BARBADOS

[74] Bird & Bird

4/F., Three Pacific Place,
1 Queen's Road East,
Hong Kong.



[11] 1802023.0

[15] 09-10-2018

[30] 09-04-2018 / US / 29/643,422

[51] Cl. 7-04

[54] 香料研磨器

Spice grinder

[73] Helen of Troy Limited
The Phoenix Centre,
George Street, Belleville,
St. Michael, BARBADOS

[74] Bird & Bird
4/F., Three Pacific Place,
1 Queen's Road East,
Hong Kong.



[11] 1802024.2

[15] 09-10-2018

[30] 09-04-2018 / US / 29/643,426

[51] Cl. 9-01

[54] 雞尾酒搖瓶

Cocktail shaker

[73] Helen of Troy Limited
The Phoenix Centre,
George Street, Belleville,
St. Michael, BARBADOS

[74] Bird & Bird
4/F., Three Pacific Place,
1 Queen's Road East,
Hong Kong.



- [11] 1802025.5
[15] 09-10-2018
[30] 09-04-2018 / US / 29/643,424
[51] Cl. 9-01
[54] 雞尾酒搖瓶
Cocktail shaker
[73] Helen of Troy Limited
The Phoenix Centre,
George Street, Belleville,
St. Michael, BARBADOS
[74] Bird & Bird
4/F., Three Pacific Place,
1 Queen's Road East,
Hong Kong.



-
- [11] 1802026.7
[15] 09-10-2018
[30] 11-04-2018 / AU / 201812126
[51] Cl. 8-03
[54] 切割刀片
Cutting blade
[73] Lambros Dimitracopoulos
12 Prince Street,
Springvale VIC 3171,
AUSTRALIA

Elias Dimitrakopoulos
Hillside Street,
Springvale VIC 3171,
AUSTRALIA
[74] HONG KONG INTELLECTUAL PROPERTY AGENT LIMITED
Unit 230, 2/F, Building 12W,
No.12 Science Park West Avenue,

Phase 3, Hong Kong Science Park, Pak Shek Kok, N.T., Hong Kong.



[11] 1802027.9

[15] 09-10-2018

[30] 24-04-2018 / JP / 008919 of 2018

[51] Cl. 28-03

[54] 按摩器

Massage apparatus

[73] 株式會社 MTG

MTG Co., Ltd.

32, HONJIN-DORI 2-CHOME, NAKAMURA-KU,
NAGOYA-SHI, AICHI-KEN 453-0041,
JAPAN

[74] CHINAHONGKONG IP LIMITED

3011, 30/F, Office Tower,
Convention Plaza, 1 Harbour Road,
Hong Kong.



[11] 1802028.1M001

[15] 09-10-2018

[30] 11-04-2018 / JP / 007952 of 2018

[51] Cl. 28-03

[54] 美容滾輪器

Rollers for cosmetic purposes

[73] 株式會社 MTG

MTG Co., Ltd.

32, HONJIN-DORI 2-CHOME, NAKAMURA-KU,
NAGOYA-SHI, AICHI-KEN 453-0041,
JAPAN

- [74] CHINAHONGKONG IP LIMITED
3011, 30/F, Office Tower,
Convention Plaza, 1 Harbour Road,
Hong Kong.



-
- [11] 1802028.1M002
[15] 09-10-2018
[30] 11-04-2018 / JP / 007949 of 2018
[51] Cl. 28-03
[54] 美容滾輪器

Rollers for cosmetic purposes

- [73] 株式會社 MTG
MTG Co., Ltd.
32, HONJIN-DORI 2-CHOME, NAKAMURA-KU,
NAGOYA-SHI, AICHI-KEN 453-0041,
JAPAN
- [74] CHINAHONGKONG IP LIMITED
3011, 30/F, Office Tower,
Convention Plaza, 1 Harbour Road,
Hong Kong.

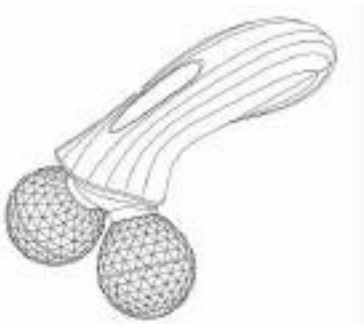

-
- [11] 1802029.3

[15] 09-10-2018

[51] Cl. 25-03

[54] 車庫

Garage

[73] LAM Fung Hing

Rm 3209, Wo On Hse,

Fung Wo Est, Shatin,

NT, Hong Kong

[74] FEDERATION OF HONG KONG INDUSTRIES

31/F, BILLION PLAZA,

8 CHEUNG YUE STREET,

CHEUNG SHA WAN , KOWLOON, HONG KONG



[11] 1802030.5

[15] 10-10-2018

[51] Cl. 9-03

[54] 包裝盒

Packaging box

[73] 金愛花

KIM AEHWA

APT 120-2004, 33, Yongjeonggongwon-ro,

Nam-gu, Incheon

KOREA, REPUBLIC OF

[74] CHINAHONGKONG IP LIMITED

3011, 30/F, Office Tower,

Convention Plaza, 1 Harbour Road,

Hong Kong.



[11] 1802031.7

[15] 10-10-2018

[51] Cl. 9-01

[54] 包裝瓶

Packaging bottle

[73] 金愛花

KIM AEHWA

APT 120-2004, 33, Yongjeonggongwon-ro,

Nam-gu, Incheon

KOREA, REPUBLIC OF

[74] CHINAHONGKONG IP LIMITED

3011, 30/F, Office Tower,

Convention Plaza, 1 Harbour Road,

Hong Kong.



[11] 1802032.9

[15] 10-10-2018

[30] 21-08-2018 / US / 29/660,389

[51] Cl. 26-05

[54] 環形燈

Ring light

[73] Erik A. Kaiser
19 Balbrook Drive Mendham,
NJ 07945,
UNITED STATES

[74] CHINAHONGKONG IP LIMITED
3011, 30/F, Office Tower,
Convention Plaza, 1 Harbour Road,
Hong Kong.



[11] 1802034.3M001

[15] 10-10-2018

[30] 12-04-2018 / EM / 005231099

[51] Cl. 28-03

[54] 剃鬚器的用戶界面

User interface for shaver

[73] Koninklijke Philips N.V.
High Tech Campus 5,
5656 AE, Eindhoven,
NETHERLANDS

[74] Wilkinson & Grist
6th Floor, Prince's Building,
Chater Road,
Hong Kong.



[11] 1802034.3M002

[15] 10-10-2018

[30] 12-04-2018 / EM / 005231099

[51] Cl. 28-03

[54] 剃鬚器的用戶界面

User interface for shaver

[73] Koninklijke Philips N.V.

High Tech Campus 5,

5656 AE, Eindhoven,

NETHERLANDS

[74] Wilkinson & Grist

6th Floor, Prince's Building,

Chater Road,

Hong Kong.



[11] 1802034.3M003

[15] 10-10-2018

[30] 12-04-2018 / EM / 005231099

[51] Cl. 28-03

[54] 剃鬚器的用戶界面

User interface for shaver

[73] Koninklijke Philips N.V.

High Tech Campus 5,

5656 AE, Eindhoven,

NETHERLANDS

[74] Wilkinson & Grist

6th Floor, Prince's Building,

Chater Road,

Hong Kong.



[11] 1802034.3M004

[15] 10-10-2018

[30] 12-04-2018 / EM / 005231099

[51] Cl. 28-03

[54] 剃鬚器的用戶界面

User interface for shaver

[73] Koninklijke Philips N.V.

High Tech Campus 5,

5656 AE, Eindhoven,

NETHERLANDS

[74] Wilkinson & Grist

6th Floor, Prince's Building,

Chater Road,

Hong Kong.



[11] 1802034.3M005

[15] 10-10-2018

[30] 12-04-2018 / EM / 005231099

[51] Cl. 28-03

[54] 剃鬚器的用戶界面

User interface for shaver

[73] Koninklijke Philips N.V.
High Tech Campus 5,
5656 AE, Eindhoven,
NETHERLANDS

[74] Wilkinson & Grist
6th Floor, Prince's Building,
Chater Road,
Hong Kong.



[11] 1802034.3M006

[15] 10-10-2018

[30] 12-04-2018 / EM / 005231099

[51] Cl. 28-03

[54] 剃鬚器的用戶界面

User interface for shaver

[73] Koninklijke Philips N.V.
High Tech Campus 5,
5656 AE, Eindhoven,
NETHERLANDS

[74] Wilkinson & Grist
6th Floor, Prince's Building,
Chater Road,
Hong Kong.



[11] 1802034.3M007

[15] 10-10-2018

[30] 12-04-2018 / EM / 005231099

[51] Cl. 28-03

[54] 剃鬚器的用戶界面

User interface for shaver

[73] Koninklijke Philips N.V.

High Tech Campus 5,

5656 AE, Eindhoven,

NETHERLANDS

[74] Wilkinson & Grist

6th Floor, Prince's Building,

Chater Road,

Hong Kong.



[11] 1802034.3M008

[15] 10-10-2018

[30] 12-04-2018 / EM / 005231099

[51] Cl. 28-03

[54] 剃鬚器的用戶界面

User interface for shaver

[73] Koninklijke Philips N.V.

High Tech Campus 5,

5656 AE, Eindhoven,

NETHERLANDS

[74] Wilkinson & Grist

6th Floor, Prince's Building,

Chater Road,

Hong Kong.



[11] 1802034.3M009

[15] 10-10-2018

[30] 12-04-2018 / EM / 005231099

[51] Cl. 28-03

[54] 剃鬚器的用戶界面

User interface for shaver

[73] Koninklijke Philips N.V.

High Tech Campus 5,

5656 AE, Eindhoven,

NETHERLANDS

[74] Wilkinson & Grist

6th Floor, Prince's Building,

Chater Road,

Hong Kong.



[11] 1802035.6

[15] 10-10-2018

[51] Cl. 9-03

[54] 紙包飲品包裝盒

Paper pack beverage packaging box

[73] Chi Wing Don WAN
7/F., The Grande Building,
398-402 Kwun Tong Road,
Hong Kong

[74] MARKS & CLERK
Level 9, Cyberport 1,
100 Cyberport Road,
Pok Fu Lam, Hong Kong.



[11] 1802036.8

[15] 10-10-2018

[30] 20-07-2018 / US / 29/657,359

[51] Cl. 21-01

[54] 玩具水下車

Toy underwater vehicle

[73] DC Comics
2900 West Alameda Avenue,
Burbank, CA 91505,
UNITED STATES

[74] Deacons
5th Floor,
Alexandra House,
Central, Hong Kong.



[11] 1802037.0

[15] 10-10-2018

[30] 20-07-2018 / US / 29/657,356

[51] Cl. 21-01

[54] 玩具水下車

Toy underwater vehicle

[73] DC Comics

2900 West Alameda Avenue,
Burbank, CA 91505,
UNITED STATES

[74] Deacons

5th Floor,
Alexandra House,
Central, Hong Kong.



[11] 1802039.4M001

[15] 10-10-2018

[30] 19-04-2018 / JP / 008654 of 2018

[51] Cl. 16-06

[54] 放大鏡用的鏡片

Lens for magnifying glass

[73] Hazuki Company Kabushiki Kaisha

10-1, Roppongi 6 chome,
Minato-ku, Tokyo,
JAPAN

[74] Deacons

5th Floor,
Alexandra House,
Central, Hong Kong.



[11] 1802039.4M002

[15] 10-10-2018

[30] 19-04-2018 / JP / 008655 of 2018

[51] Cl. 16-06

[54] 放大鏡用的鏡片

Lens for magnifying glass

[73] Hazuki Company Kabushiki Kaisha

10-1, Roppongi 6 chome,

Minato-ku, Tokyo,

JAPAN

[74] Deacons

5th Floor,

Alexandra House,

Central, Hong Kong.



[11] 1802039.4M003

[15] 10-10-2018

[30] 19-04-2018 / JP / 008656 of 2018

[51] Cl. 16-06

[54] 放大鏡用的鏡片

Lens for magnifying glass

[73] Hazuki Company Kabushiki Kaisha

10-1, Roppongi 6 chome,

Minato-ku, Tokyo,

JAPAN

[74] Deacons

5th Floor,

Alexandra House,

Central, Hong Kong.



[11] 1802039.4M004

[15] 10-10-2018

[30] 19-04-2018 / JP / 008657 of 2018

[51] Cl. 16-06

[54] 放大鏡用的鏡片

Lens for magnifying glass

[73] Hazuki Company Kabushiki Kaisha

10-1, Roppongi 6 chome,

Minato-ku, Tokyo,

JAPAN

[74] Deacons

5th Floor,

Alexandra House,

Central, Hong Kong.



[11] 1802041.8

[15] 11-10-2018

[51] Cl. 21-02

[54] 健身機

Fitness equipment

[73] 蔡焯杰

CAI Weijie

65 UBI AVENUE 1,

SINGAPORE 408939,

SINGAPORE

[74] BAKER & MCKENZIE

14th Floor, One Taikoo Place

979 King's Road, Quarry Bay

HONG KONG



- [11] 1802043.2M001
[15] 11-10-2018
[30] 10-07-2018 / LI / 2018-615
[51] Cl. 19-06
[54] 筆
Pen
- [73] Swarovski Aktiengesellschaft
Dröschistrasse 15,
9495 Triesen,
LIECHTENSTEIN
- [74] BAKER & MCKENZIE
14th Floor, One Taikoo Place
979 King's Road, Quarry Bay
HONG KONG



-
- [11] 1802043.2M002
[15] 11-10-2018
[30] 10-07-2018 / LI / 2018-615
[51] Cl. 19-06
[54] 筆
Pen
- [73] Swarovski Aktiengesellschaft
Dröschistrasse 15,
9495 Triesen,
LIECHTENSTEIN
- [74] BAKER & MCKENZIE
14th Floor, One Taikoo Place
979 King's Road, Quarry Bay
HONG KONG



[11] 1802044.4

[15] 11-10-2018

[51] Cl. 28-03

[54] 化妝品包裝用噴霧容器

Spray container for cosmetic packaging

[73] AMOREPACIFIC CORPORATION

100, Hangang-daero,

Yongsan-gu, Seoul,

KOREA, REPUBLIC OF

[74] TrademarkCN. Co. Ltd.

Blk. A, 4/F, Granville Building,

14 Granville Road, T.S.T.,

Kowloon, Hong Kong.



[11] 1802045.7M001

[15] 12-10-2018

[30] 11-06-2018 / US / 29/650,869

[51] Cl. 13-02

[54] 充電器

Power supply tower

[73] HERMAN MILLER, INC.
855 EAST MAIN AVENUE, ZEELAND,
MICHIGAN 49464, U.S.A., UNITED
STATES

[74] China Patent Agent (H.K.) Ltd.
22/F, Great Eagle Centre,
23 Harbour Road, Wanchai,
Hong Kong.



[11] 1802045.7M002

[15] 12-10-2018

[30] 11-06-2018 / US / 29/650,869

[51] Cl. 13-02

[54] 充電器

Power supply tower

[73] HERMAN MILLER, INC.
855 EAST MAIN AVENUE, ZEELAND,
MICHIGAN 49464, U.S.A., UNITED
STATES

[74] China Patent Agent (H.K.) Ltd.
22/F, Great Eagle Centre,
23 Harbour Road, Wanchai,
Hong Kong.



[11] 1802046.9

[15] 12-10-2018

[30] 12-04-2018 / GB / 6033081

[51] Cl. 28-03

[54] 手持頭髮造型設備的噴嘴附件

Attachment nozzle for a handheld hair styling device

[73] Dyson Technology Limited
Tetbury Hill, Malmesbury,
Wiltshire, SN16 0RP,
UNITED KINGDOM

[74] Liu, Shen & Associates
Room 3716, 37th Floor, Sun Hung Kai Centre,
30 Harbour Road, Wanchai,
Hong Kong.



[11] 1802047.1

[15] 12-10-2018

[51] Cl. 9-03

[54] 包裝盒

Packaging box

[73] 香港和興隆集團有限公司
Wo Hing Loong (HK) Holdings Limited
香港上水 大頭嶺
村

東慶路 211 b 地下

[74] 栢珍妮策劃有限公司
香港上環
德輔道中 199 號
無限極廣場 12 樓



[11] 1802048.3

[15] 12-10-2018

[51] Cl. 9-03

[54] 包裝盒

Packaging box

[73] 香港和興隆集團有限公司

Wo Hing Loong (HK) Holdings Limited

香港上水 大頭嶺

村

東慶路 211 b 地下

[74] 栢珍妮策劃有限公司

香港上環

德輔道中 199 號

無限極廣場 12 樓



[11] 1802049.5M001

[15] 12-10-2018

[51] Cl. 15-05

[54] 手提式吸塵器

Portable vacuum cleaner

[73] Saicome Industries Limited
Rm 1001-4, 10/F., Kwai Wu Industrial Building,
85-89 Ta Chuen Ping Street, Kwai Chung,
New Territories, Hong Kong

[74] Benny Kong Intellectual Property Limited
19B, OTB Building,
160 Gloucester Road,
Hong Kong.

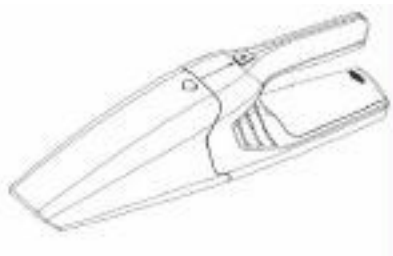

[11] 1802049.5M002

[15] 12-10-2018

[51] Cl. 15-05

[54] 手持充電式清潔刷

Handheld rechargeable cleaner

[73] Saicome Industries Limited
Rm 1001-4, 10/F., Kwai Wu Industrial Building,
85-89 Ta Chuen Ping Street, Kwai Chung,
New Territories, Hong Kong

[74] Benny Kong Intellectual Property Limited
19B, OTB Building,
160 Gloucester Road,
Hong Kong.



[11] 1802056.0

[15] 15-10-2018

[51] Cl. 14-04

[54] 用於顯示屏的圖標

Icon for display screen

[73] Kikkerland Design, Inc.

666 Broadway Ave. 4th Floor,
New York, NY 10012,
UNITED STATES

[74] Spruson & Ferguson (Hong Kong) Limited

5001 Hopewell Centre,
183 Queen's Road East,
Hong Kong.



[11] 1802058.4

[15] 15-10-2018

[51] Cl. 7-06

[54] 可分離及重複使用的吸管

Separable and reusable straw

[73] 麥子澄

香港荃灣 華都中
心 2206 室

[74] 卓遠知識產權有限公司

香港上環
禧利街 27 號
富輝商業中心 7 樓 701-702 室



- [11] 1802061.0
[15] 15-10-2018
[30] 16-04-2018 / US / 29/644,179
[51] Cl. 7-01
[54] 多用途容器
Multi-purpose container
[73] Helen of Troy Limited
The Phoenix Centre,
George Street, Belleville,
St. Michael, BARBADOS
[74] Bird & Bird
4/F., Three Pacific Place,
1 Queen's Road East,
Hong Kong.



-
- [11] 1802062.2
[15] 15-10-2018
[30] 16-04-2018 / US / 29/644,180
[51] Cl. 7-06
[54] 開瓶器
Corkscrew
[73] Helen of Troy Limited
The Phoenix Centre,
George Street, Belleville,
St. Michael, BARBADOS
[74] Bird & Bird
4/F., Three Pacific Place,
1 Queen's Road East,
Hong Kong.

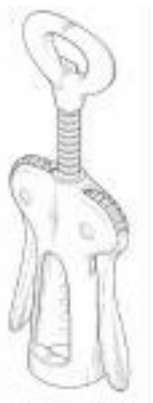

[11] 1802063.4

[15] 15-10-2018

[30] 16-04-2018 / US / 29/644,177

[51] Cl. 7-02

[54] 煮蛋器

Egg cooking device

[73] Helen of Troy Limited

The Phoenix Centre,
George Street, Belleville,
St. Michael, BARBADOS

[74] Bird & Bird

4/F., Three Pacific Place,
1 Queen's Road East,
Hong Kong.



[11] 1802064.6

[15] 15-10-2018

[30] 16-04-2018 / US / 29/644,173

[51] Cl. 7-04

[54] 削皮器

Peeler

[73] Helen of Troy Limited
The Phoenix Centre,
George Street, Belleville,
St. Michael, BARBADOS

[74] Bird & Bird
4/F., Three Pacific Place,
1 Queen's Road East,
Hong Kong.



[11] 1802065.9

[15] 15-10-2018

[30] 16-04-2018 / US / 29/644,175

[51] Cl. 7-04

[54] 削皮器

Peeler

[73] Helen of Troy Limited
The Phoenix Centre,
George Street, Belleville,
St. Michael, BARBADOS

[74] Bird & Bird
4/F., Three Pacific Place,
1 Queen's Road East,
Hong Kong.



[11] 1802066.1M001

[15] 15-10-2018

[30] 31-05-2018 / DE / 40 2018 100 531.2

[51] Cl. 16-06

[54] 擴束器

Beam expander

[73] JENOPTIK Optical Systems GmbH
Göschwitzer Strasse 25,
07745 Jena, Germany.

[74] VINCENT LUK & ASSOCIATES
Unit A, 13th Floor,
Nathan Commercial Building,
430 Nathan Road, Kowloon, Hong Kong.



[11] 1802066.1M002

[15] 15-10-2018

[30] 31-05-2018 / DE / 40 2018 100 531.2

[51] Cl. 16-06

[54] 擴束器

Beam expander

[73] JENOPTIK Optical Systems GmbH
Göschwitzer Strasse 25,
07745 Jena, Germany.

[74] VINCENT LUK & ASSOCIATES
Unit A, 13th Floor,
Nathan Commercial Building,
430 Nathan Road, Kowloon, Hong Kong.

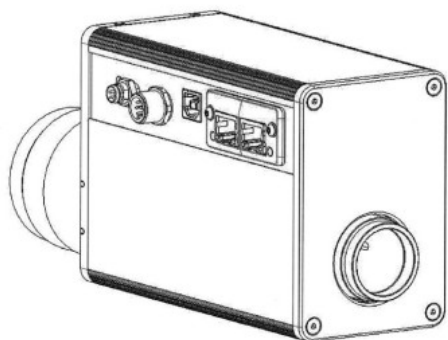

[11] 1802068.5

[15] 15-10-2018

[51] Cl. 3-01

[54] 首飾盒

Jewel case

[73] CHAUMET INTERNATIONAL S.A.

12 PLACE VENDÔME,

75001 PARIS,

FRANCE

[74] WENPING & CO.

1701 Tung Wai Commercial Building,

111 Gloucester Road,

Hong Kong.



[11] 1802069.7

[15] 15-10-2018

[51] Cl. 3-01

[54] 首飾盒

Jewel case

[73] CHAUMET INTERNATIONAL S.A.

12 PLACE VENDÔME,

75001 PARIS,
FRANCE

[74] WENPING & CO.
1701 Tung Wai Commercial Building,
111 Gloucester Road,
Hong Kong.



[11] 1802070.9

[15] 15-10-2018

[51] Cl. 3-01

[54] 首飾盒

Jewel case

[73] CHAUMET INTERNATIONAL S.A.

12 PLACE VENDÔME,

75001 PARIS,

FRANCE

[74] WENPING & CO.

1701 Tung Wai Commercial Building,

111 Gloucester Road,

Hong Kong.



[11] 1802072.3M001

[15] 16-10-2018

[30] 07-09-2018 / CN / 201830504121.9

[51] Cl. 9-03

[54] 包裝盒

Packing box

[73] 東莞唯蘭頌電子商務有限公司 中

國內地(511700)廣東省東莞市

東城街道東莞大道 11 號

台商大廈 1 單元 3905 室

[74] 百睿知識產權有限公司

香港新界沙田香港科學園

科技大道西 10 號

浚湖樓 617 室



[11] 1802072.3M002

[15] 16-10-2018

[30] 07-09-2018 / CN / 201830504121.9

[51] Cl. 9-05

[54] 包裝袋

Packing bag

[73] 東莞唯蘭頌電子商務有限公司 中

國內地(511700)廣東省東莞市

東城街道東莞大道 11 號

台商大廈 1 單元 3905 室

[74] 百睿知識產權有限公司

香港新界沙田香港科學園

科技大道西 10 號

浚湖樓 617 室

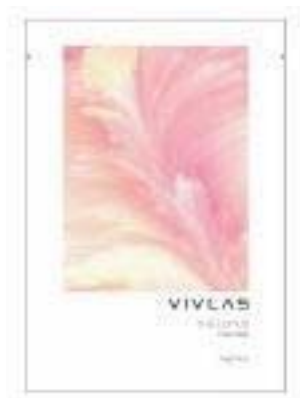

-
- [11] 1802073.5M001
[15] 16-10-2018
[30] 07-09-2018 / CN / 201830504464.5
[51] Cl. 9-03
[54] 包裝盒
Packing box
[73] 東莞唯蘭頌電子商務有限公司 中
國內地(511700)廣東省東莞市
東城街道東莞大道 11 號
台商大廈 1 單元 3905 室
[74] 百睿知識產權有限公司
香港新界沙田香港科學園
科技大道西 10 號
浚湖樓 617 室

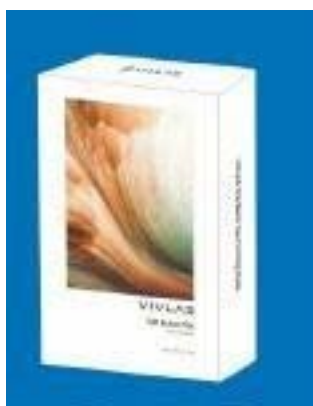

-
- [11] 1802073.5M002
[15] 16-10-2018
[30] 07-09-2018 / CN / 201830504464.5
[51] Cl. 9-05

[54] 包裝袋

Packing bag

[73] 東莞唯蘭頌電子商務有限公司 中
國內地(511700)廣東省東莞市
東城街道東莞大道 11 號
台商大廈 1 單元 3905 室

[74] 百睿知識產權有限公司
香港新界沙田香港科學園
科技大道西 10 號
浚湖樓 617 室

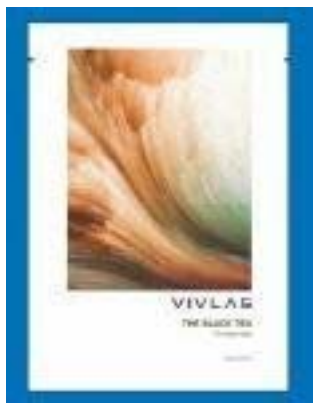

[11] 1802074.7M001

[15] 16-10-2018

[30] 03-05-2018 / MC, BE, FR, DE, HU, IT, LU, NL, KR, RO, SG, ES,
CH / DM/101 835

[51] Cl. 5-05

[54] 紡織物
Fabric

[73] CHANEL
135, avenue Charles de Gaulle,
92200 Neuilly-sur-Seine,
FRANCE

[74] Wilkinson & Grist
6th Floor, Prince's Building,
Chater Road,
Hong Kong.



[11] 1802074.7M002

[15] 16-10-2018

[30] 03-05-2018 / MC, BE, FR, DE, HU, IT, LU, NL, KR, RO, SG, ES,
CH / DM/101 835

[51] Cl. 5-05

[54] 紡織物
Fabric

[73] CHANEL
135, avenue Charles de Gaulle, 92200 Neuilly-sur-Seine, FRANCE

[74] Wilkinson & Grist
6th Floor, Prince's Building, Chater Road, Hong Kong.



[11] 1802074.7M003

[15] 16-10-2018

[30] 03-05-2018 / MC, BE, FR, DE, HU, IT, LU, NL, KR, RO, SG, ES,
CH / DM/101 835

[51] Cl. 5-05

[54] 紡織物
Fabric

[73] CHANEL
135, avenue Charles de Gaulle, 92200 Neuilly-sur-Seine, FRANCE

[74] Wilkinson & Grist
6th Floor, Prince's Building, Chater Road, Hong Kong.



[11] 1802074.7M004

[15] 16-10-2018

[30] 03-05-2018 / MC, BE, FR, DE, HU, IT, LU, NL, KR, RO, SG, ES,
CH / DM/101 835

[51] Cl. 5-05

[54] 紡織物
Fabric

[73] CHANEL
135, avenue Charles de Gaulle, 92200 Neuilly-sur-Seine, FRANCE

[74] Wilkinson & Grist
6th Floor, Prince's Building, Chater Road, Hong Kong.



[11] 1802074.7M005

[15] 16-10-2018

[30] 03-05-2018 / MC, BE, FR, DE, HU, IT, LU, NL, KR, RO, SG, ES,
CH / DM/101 835

[51] Cl. 5-05

[54] 紡織物
Fabric

[73] CHANEL
135, avenue Charles de Gaulle, 92200 Neuilly-sur-Seine, FRANCE

[74] Wilkinson & Grist
6th Floor, Prince's Building, Chater Road, Hong Kong.



[11] 1802074.7M006

[15] 16-10-2018

[30] 03-05-2018 / MC, BE, FR, DE, HU, IT, LU, NL, KR, RO, SG, ES,
CH / DM/101 835

[51] Cl. 5-05

[54] 紡織物
Fabric

[73] CHANEL
135, avenue Charles de Gaulle, 92200 Neuilly-sur-Seine, FRANCE

[74] Wilkinson & Grist
6th Floor, Prince's Building, Chater Road, Hong Kong.



[11] 1802077.4

[15] 17-10-2018

[51] Cl. 28-03

[54] 美容面膜
Cosmetic mask

[73] TAIKI CORP.,LTD.
2-16, Miyakojimakitadori 1-Chome, Miyakojima-ku,
Osaka-Shi, OSAKA, 534-0014,
Japan

[74] HONG KONG UNITALEN INTELLECTUAL PROPERTY AGENCY LIMITED
RM 1201, 12/F, GOLDEN ERA PLAZA,
39-55 SAI YEE ST, MONGKOK KLN,
HONG KONG



[11] 1802079.8

[15] 18-10-2018

[30] 08-05-2018 / CN / 201830203120.2

[51] Cl. 14-03

[54] 遙控面板

The remote control panel

[73] 廣東松下環境系統有限公司

Panasonic Ecology Systems Guangdong Co., Ltd.
2 South Chaogui Road,
Shunde High-Tech Industrial Zone (Ronggui),
Foshan, Guangdong, P.R. China 528306, CHINA

[74] MARKS & CLERK

Level 9, Cyberport 1,
100 Cyberport Road,
Pok Fu Lam, Hong Kong.

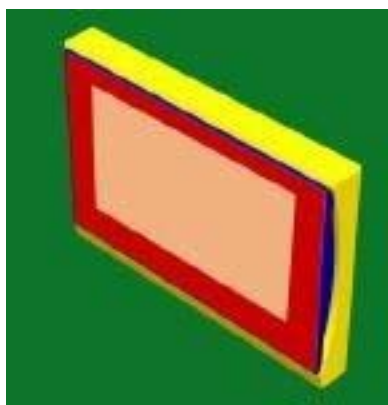

[11] 1802080.0

[15] 18-10-2018

[30] 07-09-2018 / KR / 30-2018-0041779

[51] Cl. 19-06

[54] 記號筆

Marker

- [73] TongkunAi Co., Ltd.
(Dohwa-dong)1604ho, 229, Gyeongin-ro,
Nam-gu, Incheon, 22106,
Korea, Republic of
- [74] SANYOU INTERNATIONAL INTELLECTUAL PROPERTY AGENCY (HONG KONG)
LIMITED
ROOM 601, 6/F., YUE XIU BUILDING,
160-174 LOCKHART ROAD, WANCHAI,
HONG KONG

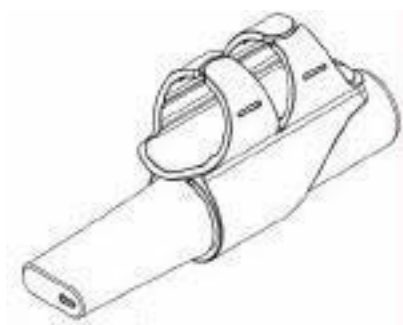

- [11] 1802082.4
- [15] 18-10-2018
- [30] 21-05-2018 / JP / 011030 of 2018
- [51] Cl. 21-01
- [54] 玩具公仔
Toy doll
- [73] Kabushiki Kaisha Bandai (Bandai Co., Ltd.)
4-8, Komagata 1-chome,
Taito-ku, Tokyo,
JAPAN
- [74] Simmons & Simmons
30th Floor, One Taikoo Place,
979 King's Road,
Hong Kong



[11] 1802083.6

[15] 18-10-2018

[51] Cl. 14-01

[54] 麥克風

Microphone

[73] Freedman Electronics Pty Limited

107 Carnarvon Street,

Silverwater NSW 2128,

AUSTRALIA

[74] BENNY KONG & TSAI

Unit 19B, Overseas Trust Bank Building,

No. 160 Gloucester Road, Wanchai,

Hong Kong.



[11] 1802086.3

[15] 19-10-2018

[51] Cl. 10-07

[54] 錶帶

Watch strap

[73] 區栢榮

香港長沙灣 元洲

邨

元泰樓 916 室

[74] 卓遠知識產權有限公司

香港

香港上環禧利街 27 號富輝商業中心 7 樓 701-702 室



[11] 1802087.5

[15] 19-10-2018

[51] Cl. 28-03

[54] 包裝用噴霧容器

Spray container for packaging

[73] AMOREPACIFIC CORPORATION

100, Hangang-daero,

Yongsan-gu, Seoul,

KOREA, REPUBLIC OF

[74] TrademarkCN. Co. Ltd.

Blk. A, 4/F, Granville Building,

14 Granville Road, T.S.T.,

Kowloon, Hong Kong.



[11] 1802088.7

[15] 19-10-2018

[30] 22-04-2018 / US / 29/644,941

[51] Cl. 11-01

[54] 寶石

Gemstone

[73] Efrayim DREZNER

10 Hate'ena street,

Shaarey Tikva,

4481000, ISRAEL

[74] CHINAHONGKONG IP LIMITED

3011, 30/F, Office Tower,

Convention Plaza, 1 Harbour Road,

Hong Kong.

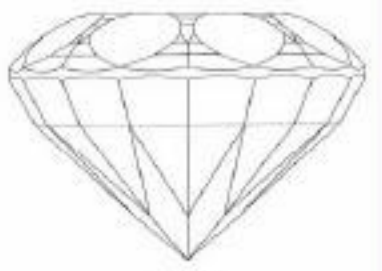

[11] 1802089.9

[15] 19-10-2018

[30] 19-04-2018 / CN / 201830163861.0

[51] Cl. 12-07

[54] 無人機

Unmanned aerial vehicle

[73] 廣州市華科爾科技股份有限公司

Guangzhou Walkera Technology Co., Ltd
Taishi Industry Zone,
Dongyong Town, Nansha District,
Guangzhou, Guangdong 511475, CHINA

[74] CHINAHONGKONG PATENT LIMITED

3012, 30/F, Office Tower,
Convention Plaza, 1 Harbour Road,
Hong Kong.



[11] 1802092.5

[15] 19-10-2018

[51] Cl. 9-05

[54] 包裝袋

Packaging bag

[73] JULIANTO TJAHJONO

JL. GAJAH MADA NO. 34,
SIDOARJO, EAST JAVA 61212,
INDONESIA

[74] Conpak Intellectual Property Limited

Rooms 05-15, 13A/F, South Tower, World Finance Centre,

Harbour City, 17 Canton Road, Tsim Sha Tsui,
Kowloon, Hong Kong.



[11] 1802093.7

[15] 22-10-2018

[51] Cl. 5-02

[54] 蕾絲

Lace

[73] Best Pacific Textile Ltd.

Jingang Road, Xinsha Port Industrial Zone,

Machong Town,

Dongguan, GD, China

[74] BEI & OCEAN (Attention to George G. Wang)

37/F, FLAT A, 8 NGA YING CHAU ST,

VILLA ESPLANDA, BLK 6, TSING YI, NT,

Hong Kong

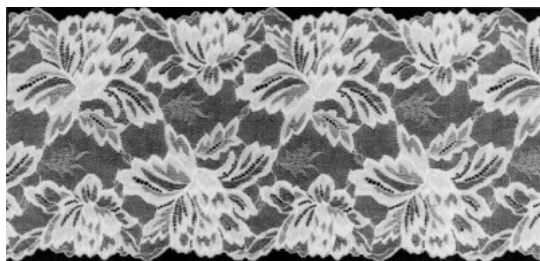

[11] 1802094.9

[15] 22-10-2018

[51] Cl. 5-02

[54] 蕾絲

Lace

[73] Best Pacific Textile Ltd.

Jingang Road, Xinsha Port Industrial Zone,

Machong Town,
Dongguan, GD, China

- [74] BEI & OCEAN (Attention to George G. Wang)
37/F, FLAT A, 8 NGA YING CHAU ST,
VILLA ESPLANDA, BLK 6, TSING YI, NT,
Hong Kong



[11] 1802095.2

[15] 22-10-2018

[51] Cl. 5-02

[54] 蕾絲

Lace

- [73] Best Pacific Textile Ltd.
Jingang Road, Xinsha Port Industrial Zone,
Machong Town,
Dongguan, GD, China

- [74] BEI & OCEAN (Attention to George G. Wang)
37/F, FLAT A, 8 NGA YING CHAU ST,
VILLA ESPLANDA, BLK 6, TSING YI, NT,
Hong Kong



[11] 1802098.8

[15] 22-10-2018

[51] Cl. 9-03

[54] 智能藥箱

Smart pill dispenser

[73] 家健科技有限公司

KIN TECHNOLOGY LIMITED
14C, CENTURY INDUSTRIAL CENTRE,
33-35 AU PUI WAN STREET, FO TAN,
SHATIN, N.T., HONG KONG

[74] HONG KONG INTELLECTUAL PROPERTY AGENT LIMITED

Unit 230, 2/F, Building 12W,
No.12 Science Park West Avenue,
Phase 3, Hong Kong Science Park, Pak Shek Kok, N.T., Hong
Kong.



[11] 1802099.0

[15] 22-10-2018

[51] Cl. 9-01

[54] 瓶

Bottle

[73] Société Jas Hennessy & Co.

Rue de la Richonne,
16100 Cognac,
FRANCE

[74] BAKER & MCKENZIE

14th Floor, One Taikoo Place
979 King's Road, Quarry Bay
HONG KONG



[11] 1802100.4M001

[15] 22-10-2018

[51] Cl. 7-01

[54] 飲料杯蓋

Lid for drinking cups

[73] HANG FUNG INTERNATIONAL INDUSTRIAL CO., LTD.

Unit 13, 8/F Harbour Centre, Tower 1,
1 Hok Cheung St., Hunghom, Kowloon,
Hong Kong

[74] UNION PATENT SERVICE CENTRE

Units E-F, 20th Floor, Neich Tower,
128 Gloucester Road,
Hong Kong.



[11] 1802100.4M002

[15] 22-10-2018

[51] Cl. 7-01

[54] 飲料杯蓋

Lids for drinking cups

[73] HANG FUNG INTERNATIONAL INDUSTRIAL CO., LTD.

Unit 13, 8/F Harbour Centre, Tower 1,
1 Hok Cheung St., Hunghom, Kowloon,
Hong Kong

[74] UNION PATENT SERVICE CENTRE
Units E-F, 20th Floor, Neich Tower,
128 Gloucester Road,
Hong Kong.

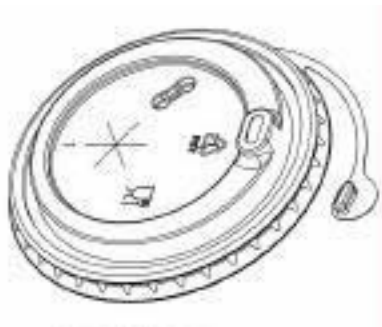

[11] 1802101.6

[15] 22-10-2018

[51] Cl. 13-02

[54] 電動車充電器

Electric vehicle charger

[73] 機場管理局

Airport Authority

Airport Authority Hong Kong, HKIA Tower,
1 Sky Plaza Road, Hong Kong International Airport,
Lantau, Hong Kong

香港理工大學

The Hong Kong Polytechnic University
The Hong Kong Polytechnic University,
Hung Hom, Kowloon, Hong Kong

[74] Lung Tin Patent Trademark Agent Ltd.

Unit 11, 10/F., Kowloon Plaza,
485 Castle Peak Road,
Kowloon, Hong Kong.

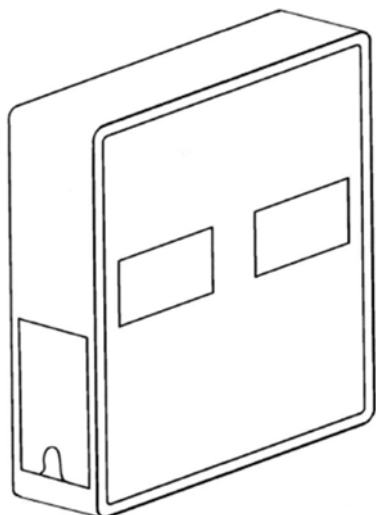

[11] 1802106.7

[15] 23-10-2018

[30] 10-05-2018 / JP / 010166 of 2018

[51] Cl. 23-04

[54] 空調機

Air conditioner

[73] Daikin Kohgyo Kabushiki Gaisha (Daikin Industries Ltd.)

Umeda Center Building,
4-12 Nakazaki-Nishi 2-chome, Kita-ku,
Osaka-shi, Osaka-fu, JAPAN

[74] MARKS & CLERK

Level 9, Cyberport 1,
100 Cyberport Road,
Pok Fu Lam, Hong Kong.



[11] 1802107.9

[15] 23-10-2018

[30] 19-10-2018 / EM, NO, KR, SG / 9575601

[51] Cl. 6-06

[54] 座椅靠背

Backrest of chair

[73] Flokk AS

Fridtjof Nansens vei 12,
0369 OSLO,
NORWAY

[74] Bird & Bird

4/F., Three Pacific Place,
1 Queen's Road East,
Hong Kong.



[11] 1802108.1

[15] 23-10-2018

[51] Cl. 9-01

[54] 飲料罐

Beverage can

[73] 高文貿易有限公司

香港葵涌 永業
街 1-3

忠信針織中心 12 樓 A1223 室

[74] 卓遠知識產權有限公司

香港上環

禧利街 27 號

富輝商業中心 7 樓 701-702 室



[11] 1802111.7

[15] 25-10-2018

[30] 27-04-2018 / JP / 009396 of 2018

[51] Cl. 23-01

[54] 噴頭

Shower head

[73] 麥克賽爾控股株式會社

MAXELL HOLDINGS, LTD.

日本京都府乙訓郡

大山崎町 大山崎小

泉 1 番地

[74] 中國專利代理(香港)有限公司

香港灣仔

港灣道 23 號

鷹君中心 22 字樓



[11] 1802112.9

[15] 25-10-2018

[30] 26-04-2018 / JP / 009236 of 2018

[51] Cl. 28-03

[54] 吹風機

Hair dryer

[73] 麥克賽爾控股株式會社

MAXELL HOLDINGS, LTD.

日本京都府乙訓郡

大山崎町 大山崎小

泉 1 番地

[74] 中國專利代理(香港)有限公司

香港灣仔

港灣道 23 號

鷹君中心 22 字樓



[11] 1802113.1

[15] 25-10-2018

[30] 27-04-2018 / JP / 009590 of 2018

[51] Cl. 28-03

[54] 皮膚護理用美容器

Beauty apparatus for skin care

[73] 麥克賽爾控股株式會社

MAXELL HOLDINGS, LTD.

日本京都府乙訓郡

大山崎町 大山崎小

泉 1 番地

[74] 中國專利代理(香港)有限公司

香港灣仔

港灣道 23 號

鷹君中心 22 字樓



[11] 1802114.3

[15] 25-10-2018

[30] 27-04-2018 / JP / 009398 of 2018

[51] Cl. 23-01

[54] 噴頭

Shower head

[73] 麥克賽爾控股株式會社

MAXELL HOLDINGS, LTD.

日本京都府乙訓郡

大山崎町 大山崎小

泉 1 番地

[74] 中國專利代理(香港)有限公司

香港灣仔

港灣道 23 號

鷹君中心 22 字樓



[11] 1802119.4

[15] 25-10-2018

[30] 28-04-2018 / US / 29/645,751

[51] Cl. 7-04

[54] 削皮器

Peeler

[73] Helen of Troy Limited

The Phoenix Centre,
George Street, Belleville
St. Michael, BARBADOS

[74] Bird & Bird

4/F., Three Pacific Place,
1 Queen's Road East,
Hong Kong.



[11] 1802120.6

[15] 25-10-2018

[30] 28-04-2018 / US / 29/645,752

[51] Cl. 7-04

[54] 削皮器

Peeler

[73] Helen of Troy Limited

The Phoenix Centre,
George Street, Belleville
St. Michael, BARBADOS

[74] Bird & Bird

4/F., Three Pacific Place,
1 Queen's Road East,
Hong Kong.



[11] 1802121.8

- [15] 25-10-2018
[30] 17-05-2018 / US / 29/647,992
[51] Cl. 9-03
[54] 包裝
Packaging
[73] DaVinci II CSJ, LLC
79 Two Bridges Road,
Fairfield, New Jersey 07004,
UNITED STATES
[74] Spruson & Ferguson (Hong Kong) Limited
5001 Hopewell Centre,
183 Queen's Road East,
Hong Kong.



-
- [11] 1802122.0
[15] 25-10-2018
[51] Cl. 31-00
[54] 麵條製作機
Noodle making machine
[73] Livingsense Co., Ltd.
2Fl., 41, Cheongnong-ro,
Bupyeong-gu, Incheon, (zip 21300)
KOREA, REPUBLIC OF
[74] CHAN, TANG & KWOK
Rooms 2503-04, 25/F.,
Shanghai Industrial Investment Building,
48-62 Hennessy Road, Wanchai, Hong Kong.



[11] 1802125.7

[15] 26-10-2018

[30] 14-05-2018 / EM, MC, KR, SG, CH, TR / DM/101 277

[51] Cl. 8-07

[54] 手袋扣

Clasp for bags

[73] Bottega Veneta SA

Via Industria 19,

Cadempino, 6814,

SWITZERLAND

[74] Rebecca Lo & Co

1408 Dina House, Ruttonjee Centre,

11 Duddell Street, Central,

Hong Kong.



[11] 1802126.9

[15] 26-10-2018

[30] 03-05-2018 / EM / 005256849-0001

[51] Cl. 28-03

[54] 理髮器

Hair clipper

[73] WAHL GmbH

Roggenbachweg 9,

78089 Unterkirnach,

GERMANY

- [74] Deacons
5th Floor,
Alexandra House,
Central, Hong Kong.



[11] 1802127.1

[15] 26-10-2018

[51] Cl. 12-11

[54] 電動自行車

Electric bicycle

[73] E-Mobility Limited
11/F, Metropole Square 2,
On Yiu Street, Shatin,
Hong Kong

[74] MARKS & CLERK
Level 9, Cyberport 1,
100 Cyberport Road,
Pok Fu Lam, Hong Kong.



[11] 1802128.3

[15] 26-10-2018

[30] 25-05-2018 / EM, JP, NO, SG, CH / DM/101 485

[51] Cl. 7-01

[54] 飲料容器的蓋

Lid for drinking vessels

[73] Pi-Design AG

Kantonsstrasse 100,

CH-6234 Triengen,

SWITZERLAND

[74] WENPING & CO.

1701 Tung Wai Commercial Building,

111 Gloucester Road,

Hong Kong.



[11] 1802129.5

[15] 26-10-2018

[30] 27-06-2018 / EM, NO, SG, CH / DM/101 897

[51] Cl. 7-07

[54] 午餐盒

Lunch box

[73] Pi-Design AG

Kantonsstrasse 100,

CH-6234 Triengen,

SWITZERLAND

[74] WENPING & CO.

1701 Tung Wai Commercial Building,

111 Gloucester Road,

Hong Kong.



[11] 1802135.8

[15] 30-10-2018

[30] 29-09-2018 / EM / 005668589-0001

[51] Cl. 13-02

[54] 無線充電器

Wireless charger

[73] 深圳市道格拉斯科技有限公司

中國內地

深圳市龍華新區 觀瀾核電工

業園 4 棟 5 樓

[74] 金信智權有限公司

香港觀塘

偉業街 221 號

美德工業大廈 D 座 10/F 38 室



[11] 1802136.0

[15] 30-10-2018

[30] 30-05-2018 / EM / 005289592

[51] Cl. 2-04

[54] 鞋

Shoe

[73] VALENTINO S.p.A.

Via Turati, 16/18,

I-20121 MILANO,

ITALY

[74] Barron & Young Intellectual Property Limited

Suite 617, Lakeside 2,

No. 10 Science Park West Avenue,
Hong Kong Science Park, N.T., Hong Kong.



[11] 1802138.4

[15] 30-10-2018

[51] Cl. 3-01

[54] 隱形眼鏡盒

Contact lens case

[73] MENICON CO., LTD.

3-21-19, AOI, NAKA-KU,

NAGOYA-SHI AICHI 460-0006 Japan

[74] HONG KONG UNITALEN INTELLECTUAL PROPERTY AGENCY LIMITED

RM 1201, 12/F, GOLDEN ERA PLAZA, 39-55 SAI YEE ST, MONGKOK

KLN, HONG KONG

HONG KONG

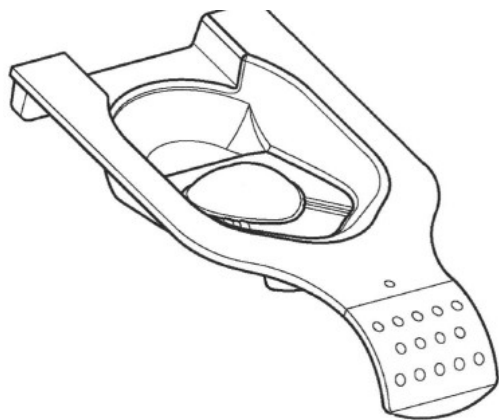



香港特別行政區政府知識產權署外觀設計註冊處

The Government of the Hong Kong Special Administrative Region

Designs Registry, Intellectual Property Department

根據註冊外觀設計條例第28條，下列註冊外觀設計因未繳續期費而停止有效。各組記項按註冊外觀設計停止有效日期及註冊編號先後次序排列。

Registered designs ceased through non-payment of renewal fees under section 28 of the Registered Designs Ordinance. Entries are listed below under their expiry dates.

26-04-2019 - 30-04-2019

26-04-2019	1400781.1M004	1400817.9
0410887.6	1400782.3	1400818.1M001
0410888.8	1400783.5M001	1400818.1M002
0900666.1	1400783.5M002	1400818.1M003
0900667.3	1400784.7	
0900668.5	1400785.0	
0900669.7	1400786.2	
0900670.9	1400787.4	
0900674.7	1400788.6	
0900675.0	1400789.8	
0900676.2M001	1400790.0	
0900676.2M002	1400791.2	
0900676.2M003	1400792.4	
0900680.0M001	1400793.6	
0900680.0M002	1400794.8	
1000794.4	1400795.1	

27-04-2019

0410903.1M001	1400796.3	
0410903.1M002	1400797.5M001	
0410903.1M003	1400797.5M002	
0410905.6	1400798.7	
0410912.0	9910508.8	

0410913.2	28-04-2019	
0410914.4	0900692.5	
0900682.4	0900693.7M001	
0900683.6	0900693.7M002	
0900685.1	0900693.7M004	
0900686.3M003	0900693.7M005	
0900686.3M004	0900693.7M006	
0900686.3M007	1400799.9	
0900686.3M008	1400800.3	
0900686.3M009	1400801.5M001	
1400771.0M001	1400801.5M002	
1400771.0M002	1400802.7	
1400772.2	9910512.6	

1400773.4	29-04-2019	
1400774.6	0410921.9	
1400775.9	1400804.1	
1400776.1	1400805.4	
1400777.3	1400806.6	
1400778.5	1400807.8	
1400779.7M001	1400808.0	
1400779.7M002	1400809.2	
1400779.7M003	1400810.4	
1400780.9M001	1400811.6	
1400780.9M002	1400812.8	
1400780.9M003	1400813.0	
1400781.1M001	1400814.2	
1400781.1M002	1400815.5	
1400781.1M003	1400816.7	



香港特別行政區政府知識產權署外觀設計註冊處

The Government of the Hong Kong Special Administrative Region
Designs Registry, Intellectual Property Department

勘誤 **CORRIGENDUM**

於 2019 年 04 月 26 日公布的香港知識產權公報的分項“根據註冊外觀設計條例第 25 條註冊的外觀設計”應包括以下記項：

The following entries should have been included in the section “Designs Registered under section 25 of the Registered Designs Ordinance” of the Hong Kong Intellectual Property Journal published on 26 April 2019:

- [11] 1801948.1M001
- [15] 22-09-2018
- [30] 13-09-2018 / US / 29/663,293
- [51] Cl. 14 - 99
- [54] 通訊頭戴式送受話器的基座
Base cradle for a communications headset
- [73] 繽特力股份有限公司
PLANTRONICS, INC.
345 Encinal St.,
Santa Cruz, CA 95060,
UNITED STATES
- [74] Shanghai Intellectual Property Office
Unit F, 20th Floor, Neich Tower,
128 Gloucester Road,
Hong Kong.

