

香港知識產權公報

Hong Kong Intellectual Property Journal

2020年7月17日

17 July 2020

目錄 Contents

根據註冊外觀設計條例第 25 條註冊的外觀設計

Designs Registered under section 25 of the Registered Designs Ordinance

按註冊編號排列

Arranged by Registration Number

根據註冊外觀設計條例(第 522 章)公布的其他公告

Other Notices Published under the Registered Designs Ordinance (Cap. 522)

根據註冊外觀設計條例第 28 條，註冊外觀設計因未繳續期費而停止有效

Registered designs ceased through non-payment of renewal fees under section 28 of the Registered Designs Ordinance

根據註冊外觀設計規則第 31 條刪除的註冊外觀設計

Registered designs removed under section 31 of the Registered Designs Rules

勘誤

Corrigendum

以下事項沒有記錄

No Records for the Following Matters

根據註冊外觀設計條例第 30 條放棄的外觀設計的註冊

Surrender of Registration of Design under section 30 of the Registered Designs Ordinance

根據註冊外觀設計規則第 37 條，向處長作出轉介

Reference to Registrar under section 37 of the Registered Designs Rules

根據註冊外觀設計條例第 45 條，撤銷註冊

Revocation of Registration under section 45 of the Registered Designs Ordinance

根據註冊外觀設計規則第 46 條，向法院作出轉介

Reference to Court under section 46 of the Registered Designs Rules

根據註冊外觀設計規則第 63 條對不符合規定之處作出糾正

Rectification of Irregularities under section 63 of the Registered Designs Rules

根據註冊外觀設計條例第 66 條，糾正註冊紀錄冊

Rectification of Register under section 66 of the Registered Designs Ordinance

根據註冊外觀設計條例第 67 條 更正註冊紀錄冊內的錯誤

Correction of errors in Register under section 67 of the Registered Designs Ordinance

根據註冊外觀設計條例第 67 及 76 條，更正註冊紀錄冊內及已提交文件中的錯誤

Correction of Errors in Register and in Filed Documents under sections 67 and 76 of the Registered Designs Ordinance

根據註冊外觀設計條例第 76 條，更正已提交文件中的錯誤

Correction of errors in filed documents under section 76 of the Registered Designs Ordinance

註冊外觀設計公告註釋

Notes on advertisements of registration of designs

方括號表示下列資料：

Square brackets indicate the following data：

[11] 註冊編號 Registration number / 聯合王國註冊編號 United Kingdom registration number

[15] 註冊日期 Registration date / 當作註冊日期 Deemed registration date / 聯合王國註冊日期 United Kingdom registration date

[17] 註冊有效期屆滿日期 Expiry date of the period of registration

[22] 提交日期 Filing date / 當作提交日期 Deemed filing date / 聯合王國提交日期 United Kingdom filing date

[30] 聲稱享有的優先權（提交日期 / 巴黎公約國或世界貿易組織成員 / 申請編號） Priority claimed (filing date / Paris Convention country or WTO member / application number)

[51] 國際外觀設計分類號（洛迦諾分類號） International Classification of designs (Locarno Classification)

[54] 物品 Article

[55] 外觀設計的表述 Representation of the design

[62] 分開前的申請編號及提交日期 Application number before division and filing date

[66] 過往註冊的聯繫外觀設計註冊編號 / 日期 Registration No. / Date of Previous Registration for Association

[72] 設計人 Designer

[73] 擁有人姓名和地址 Name and address of the owner

[74] 代理人 Agent /送達地址 Address for service



香港特別行政區政府知識產權署外觀設計註冊處

The Government of the Hong Kong Special Administrative Region

Designs Registry, Intellectual Property Department

根據註冊外觀設計條例第 25 條註冊的外觀設計

Designs registered under section 25 of the Registered Designs Ordinance

按註冊編號排列

Arranged by Registration Number

- [11] 1913306.5M001
- [15] 26-03-2019
- [30] 26-09-2018 / EU / 005660628
- [51] Cl. 14-99
- [54] 支架
Holder
- [73] Erwin Müller GmbH
Breslauer Str. 34-38
D-49808 Lingen (Ems)
GERMANY
- [74] UNITALEN ATTORNEYS AT LAW LIMITED
RM 1201, 12/F,
GOLDEN ERA PLAZA,
39-55 SAI YEE ST, MONGKOK KLN
HONG KONG

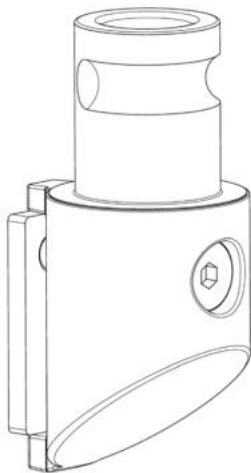

-
- [11] 1913306.5M002

- [15] 26-03-2019
- [30] 26-09-2018 / EU / 005660628
- [51] Cl. 14-99
- [54] 支架
Holder
- [73] Erwin Müller GmbH
Breslauer Str. 34-38
D-49808 Lingen (Ems)
GERMANY
- [74] UNITALEN ATTORNEYS AT LAW LIMITED
RM 1201, 12/F,
GOLDEN ERA PLAZA,
39-55 SAI YEE ST, MONGKOK KLN
HONG KONG

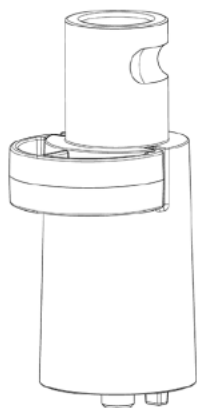

-
- [11] 1913306.5M003
- [15] 26-03-2019
- [30] 26-09-2018 / EU / 005660628
- [51] Cl. 14-99
- [54] 支架
Holder
- [73] Erwin Müller GmbH
Breslauer Str. 34-38
D-49808 Lingen (Ems)
GERMANY
- [74] UNITALEN ATTORNEYS AT LAW LIMITED
RM 1201, 12/F,
GOLDEN ERA PLAZA,
39-55 SAI YEE ST, MONGKOK KLN
HONG KONG

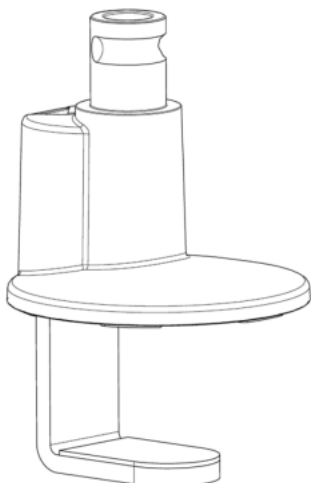

[11] 1913306.5M004

[15] 26-03-2019

[30] 26-09-2018 / EU / 005660628

[51] Cl. 14-99

[54] 支架

Holder

[73] Erwin Müller GmbH

Breslauer Str. 34-38

D-49808 Lingen (Ems)

GERMANY

[74] UNITALEN ATTORNEYS AT LAW LIMITED

RM 1201, 12/F,

GOLDEN ERA PLAZA,

39-55 SAI YEE ST, MONGKOK KLN

HONG KONG



- [11] 1913306.5M005
[15] 26-03-2019
[30] 26-09-2018 / EU / 005660628
[51] Cl. 14-99
[54] 支架
Holder
[73] Erwin Müller GmbH
Breslauer Str. 34-38
D-49808 Lingen (Ems)
GERMANY
[74] UNITALEN ATTORNEYS AT LAW LIMITED
RM 1201, 12/F,
GOLDEN ERA PLAZA,
39-55 SAI YEE ST, MONGKOK KLN
HONG KONG

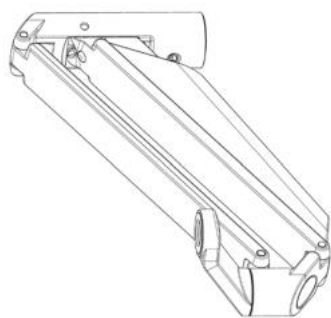

-
- [11] 1913306.5M006
[15] 26-03-2019
[30] 26-09-2018 / EU / 005660628
[51] Cl. 14-99
[54] 支架
Holder
[73] Erwin Müller GmbH
Breslauer Str. 34-38
D-49808 Lingen (Ems)
GERMANY
[74] UNITALEN ATTORNEYS AT LAW LIMITED
RM 1201, 12/F,
GOLDEN ERA PLAZA,
39-55 SAI YEE ST, MONGKOK KLN
HONG KONG

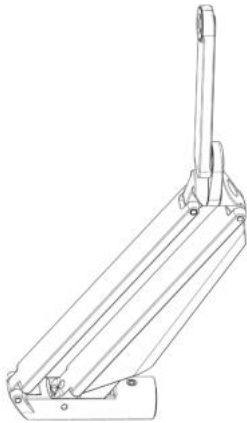

[11] 1913306.5M007

[15] 26-03-2019

[30] 26-09-2018 / EU / 005660628

[51] Cl. 14-99

[54] 支架

Holder

[73] Erwin Müller GmbH

Breslauer Str. 34-38

D-49808 Lingen (Ems)

GERMANY

[74] UNITALEN ATTORNEYS AT LAW LIMITED

RM 1201, 12/F,

GOLDEN ERA PLAZA,

39-55 SAI YEE ST, MONGKOK KLN

HONG KONG

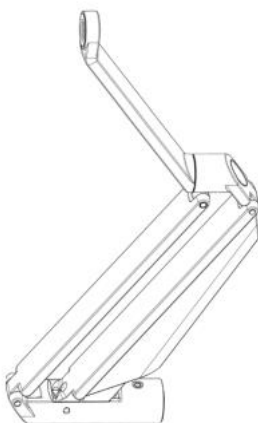

[11] 1913306.5M008

[15] 26-03-2019

[30] 26-09-2018 / EU / 005660628

[51] Cl. 14-99

[54] 支架

Holder

[73] Erwin Müller GmbH

Breslauer Str. 34-38

D-49808 Lingen (Ems)

GERMANY

[74] UNITALEN ATTORNEYS AT LAW LIMITED

RM 1201, 12/F,

GOLDEN ERA PLAZA,

39-55 SAI YEE ST, MONGKOK KLN

HONG KONG



[11] 1913306.5M009

[15] 26-03-2019

[30] 26-09-2018 / EU / 005660628

[51] Cl. 14-99

[54] 支架

Holder

[73] Erwin Müller GmbH

Breslauer Str. 34-38

D-49808 Lingen (Ems)

GERMANY

[74] UNITALEN ATTORNEYS AT LAW LIMITED

RM 1201, 12/F,

GOLDEN ERA PLAZA,

39-55 SAI YEE ST, MONGKOK KLN

HONG KONG

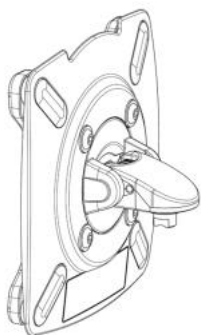

[11] 1913306.5M010

[15] 26-03-2019

[30] 26-09-2018 / EU / 005660628

[51] Cl. 14-99

[54] 支架

Holder

[73] Erwin Müller GmbH

Breslauer Str. 34-38

D-49808 Lingen (Ems)

GERMANY

[74] UNITALEN ATTORNEYS AT LAW LIMITED

RM 1201, 12/F,

GOLDEN ERA PLAZA,

39-55 SAI YEE ST, MONGKOK KLN

HONG KONG

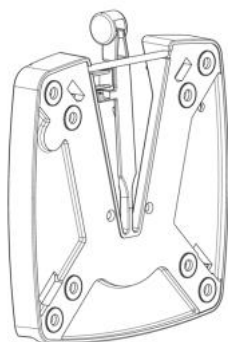

[11] 1913306.5M011

[15] 26-03-2019

[30] 26-09-2018 / EU / 005660628

[51] Cl. 14-99

[54] 支架

Holder

[73] Erwin Müller GmbH
Breslauer Str. 34-38
D-49808 Lingen (Ems)
GERMANY

[74] UNITALEN ATTORNEYS AT LAW LIMITED
RM 1201, 12/F,
GOLDEN ERA PLAZA,
39-55 SAI YEE ST, MONGKOK KLN
HONG KONG

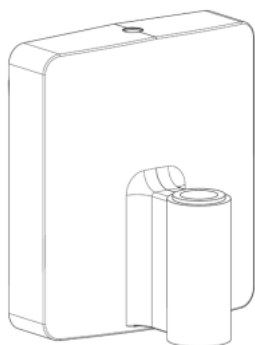

[11] 1913306.5M012
[15] 26-03-2019
[30] 26-09-2018 / EU / 005660628
[51] Cl. 14-99
[54] 支架
Holder

[73] Erwin Müller GmbH
Breslauer Str. 34-38
D-49808 Lingen (Ems)
GERMANY

[74] UNITALEN ATTORNEYS AT LAW LIMITED
RM 1201, 12/F,
GOLDEN ERA PLAZA,
39-55 SAI YEE ST, MONGKOK KLN
HONG KONG



[11] 1914229.2M001

[15] 15-07-2019

[51] Cl. 9-03

[54] 用於包裝的裝飾

Ornamentation for packaging

[73] LOUIS VUITTON MALLETIER

2 rue du Pont-Neuf

75001 Paris

FRANCE

[74] BAKER & MCKENZIE

14TH FLOOR, ONE TAIKOO PLACE,

979 KING'S ROAD, QUARRY BAY,

HONG KONG



[11] 1914229.2M002

[15] 15-07-2019

[51] Cl. 9-03

[54] 用於包裝的裝飾

Ornamentation for packaging

[73] LOUIS VUITTON MALLETIER

2 rue du Pont-Neuf

75001 Paris

FRANCE

[74] BAKER & MCKENZIE

14TH FLOOR, ONE TAIKOO PLACE,

979 KING'S ROAD, QUARRY BAY,

HONG KONG



[11] 1914333.2M001

[15] 29-07-2019

[30] 12-03-2019 / AM, AZ, BZ, BA, GE, LI, MK, MD, MC, MN, ME, MA,
NO, OM, SG, CH, TN, TR, UA, GB, EU, AL, KG / DM/200 689

[51] Cl. 10-02

[54] 錶

Watch

[73] OMEGA SA (OMEGA AG) (OMEGA LTD.)

Jakob-Stämpfli-Strasse 96, CH-2502 Biel/Bienne,
SWITZERLAND

[74] SPRUSON & FERGUSON (HONG KONG) LIMITED

5001 Hopewell Centre
183 Queen's Road East, Wan Chai
HONG KONG



[11] 1914333.2M002

[15] 29-07-2019

[30] 12-03-2019 / AM, AZ, BZ, BA, GE, LI, MK, MD, MC, MN, ME, MA,
NO, OM, SG, CH, TN, TR, UA, GB, EU, AL, KG / DM/200 689

[51] Cl. 10-07

[54] 手錶的支撐物

Support for wrist watch

[73] OMEGA SA (OMEGA AG) (OMEGA LTD.)

Jakob-Stämpfli-Strasse 96, CH-2502 Biel/Bienne,
SWITZERLAND

[74] SPRUSON & FERGUSON (HONG KONG) LIMITED

5001 Hopewell Centre
183 Queen's Road East, Wan Chai
HONG KONG

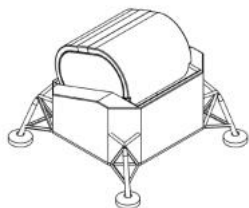

[11] 1914729.3

[15] 26-09-2019

[30] 26-03-2019 / US / 29/685,127

[51] Cl. 21-01

[54] 玩具飛鏢

Toy dart

[73] HASBRO, INC.

1027 Newport Avenue,
Pawtucket, Rhode Island 02862-1059
UNITED STATES OF AMERICA

[74] Bird & Bird

6/F, The Annex, Central Plaza
18 Harbour Road
Hong Kong

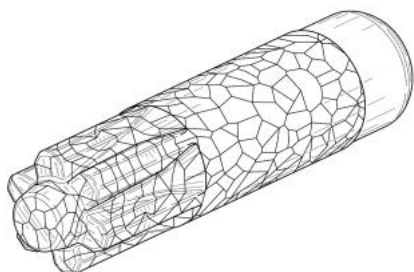

[11] 1914862.4

[15] 23-10-2019

[51] Cl. 21-01

[54] 機器人玩具

Robot toy

[73] 李浩迅

LI HO SHUN ORSON

Flat 11C, Jovial Court,

Discovery Bay,

Hong Kong

[74] LI HO SHUN ORSON

Unit 2302, 23/F, New World Tower 1,

18 Queen's Road, Central,

Hong Kong

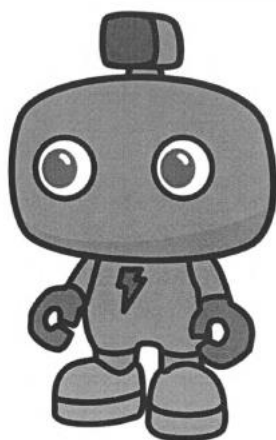

[11] 1915065.5

[15] 25-11-2019

[51] Cl. 7-04

[54] 矽膠鍋鏟

Silicone spatula

[73] 誠信行貿易有限公司

Lexington Limited

香港

天后英皇道 26-36 號

興漢大廈地下 5 號鋪

[74] 弘研知識產權有限公司

香港

九龍佐敦渡船街 28 號

寶時商業中心 20 樓 2006-2007 室



[11] 1915067.9

[15] 25-11-2019

[51] Cl. 9-05

[54] 長方形硅膠多用途密封袋

Rectangular silicone multi-functional zip bag

[73] 誠信行貿易有限公司

Lexington Limited

香港

天后英皇道 26-36 號

興漢大廈地下 5 號鋪

[74] 弘研知識產權有限公司

香港

九龍佐敦渡船街 28 號

寶時商業中心 20 樓 2006-2007 室



[11] 1915118.8

[15] 28-11-2019

[51] Cl. 8-08

[54] 掛架
Hanger

[73] 宏圖空間信息顧問有限公司
AMBIT GEOSPATIAL SOLUTION LIMITED
FLAT/RM A, 16/F, REGENCY CENTRE PHASE II
43 WONG CHUK HANG ROAD
HONG KONG

[74] HONG KONG UTC INTELLECTUAL PROPERTY (HOLDINGS) LIMITED
文景大廈 5 樓 5B 單元
上環文鹹西街 9-11 號
HONG KONG
HONG KONG

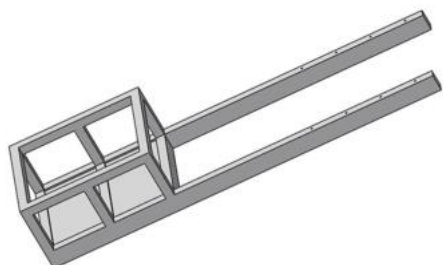

[11] 1915119.0

[15] 28-11-2019

[30] 31-05-2019 / CN / 201930276429.7

[51] Cl. 11-01

[54] 三粒石吊墜
Three stones pendant

[73] 黃智祥
Huang Zhixiang
中國內地
廣東省惠州市惠陽區淡水街道辦事處
富華樓西區 2 棟 503 室

關永光
KWAN, Wing Kwong
中國內地
廣東省深圳市羅湖區布心東興工業區
48 號 B 座日生行

[74] HONG KONG UTC INTELLECTUAL PROPERTY (HOLDINGS) LIMITED
文景大廈 5 樓 5B 單元
上環文鹹西街 9-11 號

HONG KONG
HONG KONG



[11] 1915160.6

[15] 03-12-2019

[51] Cl. 3-01

[54] 冷藏蔬菜儲存小袋連包裝

Vegetable storage pouch for refrigeration with packaging

[73] Kao Ya Trading Limited

Flat D, 13/F., Manley House,
86-98 Canton Road, Tsimshatsui,
Kowloon, Hong Kong

[74] Kao Ya Trading Limited

Flat D, 13/F., Manley House,
86-98 Canton Road, Tsimshatsui,
Kowloon, Hong Kong



[11] 1915190.9

- [15] 05-12-2019
- [51] Cl. 10-02
- [54] 三角形表面手錶
Triangle dial watch
- [73] 格林控股有限公司
Glamm Holdings Limited
香港九龍
達之路 72 號
創新中心 216B 室
- [74] Glamm Holdings Limited
香港九龍
達之路 72 號
創新中心 216B 室



-
- [11] 1915235.6M001
- [15] 13-12-2019
- [30] 18-06-2019 / GB, EU / DM/202 852
- [51] Cl. 9-01
- [54] 瓶
Flask
- [73] MONTBLANC SIMPLO GmbH
Hellgrundweg 100,
22525 Hamburg,
Germany
- [74] Wenping Patent & Trade Mark Agent Limited
1701 Tung Wai Commercial Building,
111 Gloucester Road,
Hong Kong

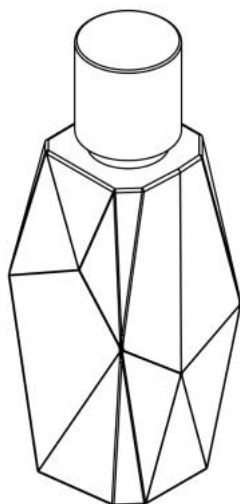

[11] 1915235.6M002

[15] 13-12-2019

[30] 18-06-2019 / GB, EU / DM/202 852

[51] Cl. 9-01

[54] 瓶

Flask

[73] MONTBLANC SIMPLO GmbH

Hellgrundweg 100,

22525 Hamburg,

Germany

[74] Wenping Patent & Trade Mark Agent Limited

1701 Tung Wai Commercial Building,

111 Gloucester Road,

Hong Kong

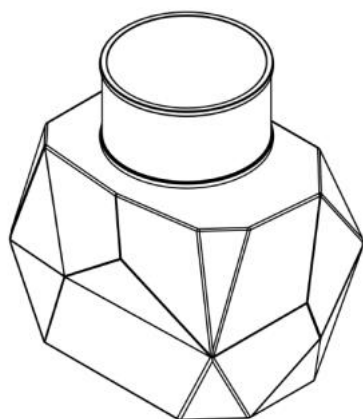

[11] 1915256.0M001

- [15] 17-12-2019
[30] 24-07-2019 / EU / 006644670-0001
[51] Cl. 24-01
[54] 醫療監察器
Medical monitor
[73] Koninklijke Philips N.V.
High Tech Campus 5,
5656 AE Eindhoven,
Netherlands
[74] Wilkinson & Grist
6th Floor, Prince's Building,
Chater Road,
Hong Kong

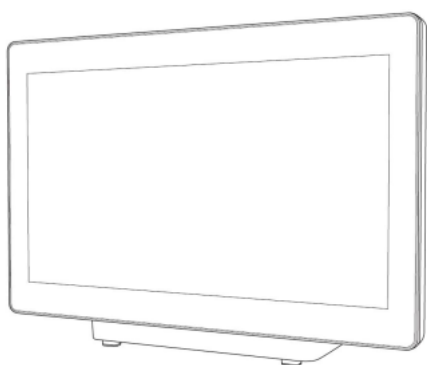

-
- [11] 1915256.0M002
[15] 17-12-2019
[30] 24-07-2019 / EU / 006644670-0002
[51] Cl. 24-01
[54] 醫療監察器
Medical monitor
[73] Koninklijke Philips N.V.
High Tech Campus 5,
5656 AE Eindhoven,
Netherlands
[74] Wilkinson & Grist
6th Floor, Prince's Building,
Chater Road,
Hong Kong

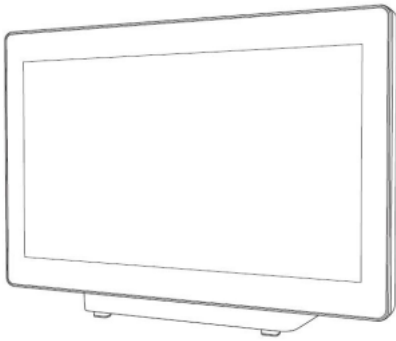

[11] 1915256.0M003

[15] 17-12-2019

[30] 24-07-2019 / EU / 006644670-0003

[51] Cl. 24-01

[54] 醫療監察器

Medical monitor

[73] Koninklijke Philips N.V.

High Tech Campus 5,

5656 AE Eindhoven,

Netherlands

[74] Wilkinson & Grist

6th Floor, Prince's Building,

Chater Road,

Hong Kong



[11] 1915256.0M004

[15] 17-12-2019

[30] 24-07-2019 / EU / 006644670-0004

[51] Cl. 24-01

[54] 醫療監察器

Medical monitor

[73] Koninklijke Philips N.V.

High Tech Campus 5,
5656 AE Eindhoven,
Netherlands

[74] Wilkinson & Grist

6th Floor, Prince's Building,
Chater Road,
Hong Kong



[11] 1915272.3M001

[15] 18-12-2019

[30] 18-06-2019 / FR / 2019-2788

[51] Cl. 16-06

[54] 太陽眼鏡

Sunglasses

[73] Louis Vuitton Malletier

2 rue du Pont-Neuf,
75001 Paris,
France

[74] Baker & McKenzie

14th Floor, One Taikoo Place,
979 King's Road,
Quarry Bay, Hong Kong

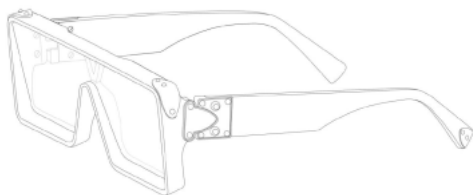

[11] 1915284.8M001

[15] 20-12-2019

[51] Cl. 14-02

[54] 讀卡器

Card reader

[73] Matrix Research Limited

香港新界荃灣

白田壩街 5-21 號

嘉力工業中心 A 座 16 樓 22 室

[74] Matrix Research Limited

香港新界荃灣

白田壩街 5-21 號

嘉力工業中心 A 座 16 樓 22 室

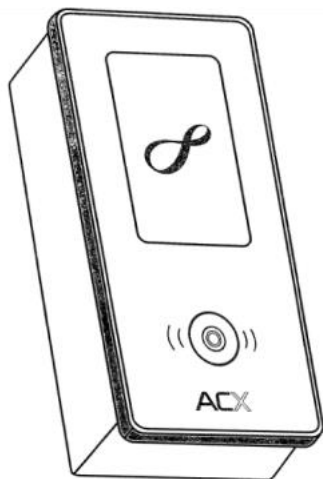

[11] 1915284.8M002

[15] 20-12-2019

[51] Cl. 14-02

[54] 讀卡器

Card reader

[73] Matrix Research Limited

香港新界荃灣

白田壩街 5-21 號

嘉力工業中心 A 座 16 樓 22 室

[74] Matrix Research Limited

香港新界荃灣

白田壩街 5-21 號

嘉力工業中心 A 座 16 樓 22 室



[11] 1915284.8M003

[15] 20-12-2019

[51] Cl. 14-02

[54] 讀卡器

Card reader

[73] Matrix Research Limited

香港新界荃灣

白田壩街 5-21 號

嘉力工業中心 A 座 16 樓 22 室

[74] Matrix Research Limited

香港新界荃灣

白田壩街 5-21 號

嘉力工業中心 A 座 16 樓 22 室



[11] 1915284.8M004

[15] 20-12-2019

[51] Cl. 14-02

[54] 讀卡器

Card reader

[73] Matrix Research Limited

香港新界荃灣

白田壩街 5-21 號

嘉力工業中心 A 座 16 樓 22 室

[74] Matrix Research Limited

香港新界荃灣

白田壩街 5-21 號

嘉力工業中心 A 座 16 樓 22 室



[11] 1915284.8M005

[15] 20-12-2019

[51] Cl. 14-02

[54] 讀卡器

Card reader

[73] Matrix Research Limited

香港新界荃灣

白田壩街 5-21 號

嘉力工業中心 A 座 16 樓 22 室

[74] Matrix Research Limited

香港新界荃灣

白田壩街 5-21 號

嘉力工業中心 A 座 16 樓 22 室



[11] 1915284.8M006

[15] 20-12-2019

[51] Cl. 14-02

[54] 電子郵件驗證設備

Email authenticate device

[73] Matrix Research Limited

香港新界荃灣

白田壩街 5-21 號

嘉力工業中心 A 座 16 樓 22 室

[74] Matrix Research Limited

香港新界荃灣

白田壩街 5-21 號

嘉力工業中心 A 座 16 樓 22 室



[11] 1915312.9

[15] 24-12-2019

[30] 01-07-2019 / JP / 014751 of 2019

[51] Cl. 28-04

[54] 增髮用具

Hair adding tool

[73] Aderans Company Limited

愛德蘭絲株式會社

6-3, Shinjuku 1-chome, Shinjuku-ku,

Tokyo 160-8429,

Japan

[74] 范紀羅江律師行

香港灣仔

港灣道 6-8 號

瑞安中心 23 樓

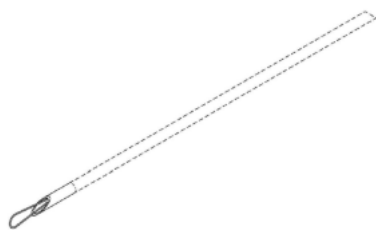

[11] 1915338.4

[15] 27-12-2019

[30] 25-06-2019 / DE / 40 2019 100 688.5

[51] Cl. 24-02

[54] 醫用容器

Container for medical use

[73] 佩里帕爾公司

PERIPAL AG

Bahnhofstrasse 78 ch-8001,

Zürich, Switzerland

[74] CHINAHONGKONG IP LIMITED

3011, 30/F, Office Tower,

Convention Plaza,

1 Harbour Road,

Hong Kong

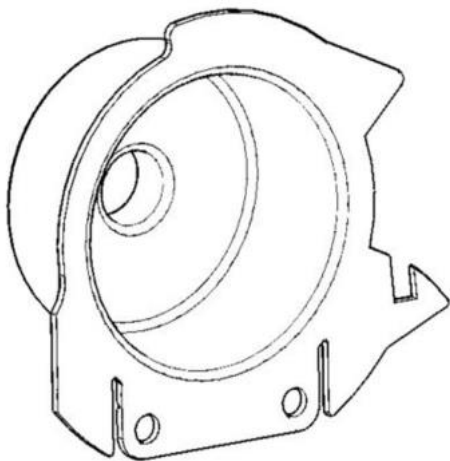

[11] 1915342.2

[15] 30-12-2019

[51] C1. 11-02

[54] 黃大仙像雕塑

Wong tai sin sculpture

[73] 齋色園

SIK SIK YUEN

香港

黃大仙竹園邨二號

[74] 齋色園

香港

黃大仙竹園邨二號



[11] 2015419.9

[15] 15-01-2020

[30] 15-07-2019 / EU / 006628194

[51] C1. 12-16

- [54] 車輛視覺顯示單元
Visual display unit for vehicle
- [73] Group Lotus Limited
Potash Lane, Hethel, Norwich,
Norfolk NR14 8EZ,
United Kingdom
- [74] UNION PATENT SERVICE CENTRE
Units E-F, 20th Floor, Neich Tower,
128 Gloucester Road,
Hong Kong

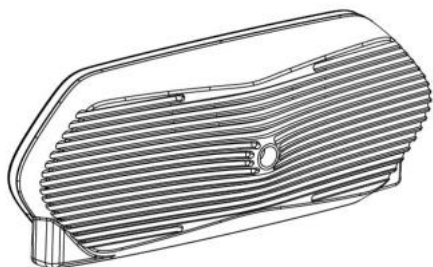

-
- [11] 2015464.3
- [15] 21-01-2020
- [30] 30-07-2019 / CA, FR, MA, RU, SG, CH, TN, TR, GB, US, EU, JP,
KR / DM/204 860
- [51] Cl. 11-01
- [54] 手鐲
Bracelet
- [73] HERMES SELLIER
24, rue du Faubourg Saint Honoré,
F-75008 Paris,
France
- [74] DEACONS
5th Floor,
Alexandra House,
Central, Hong Kong

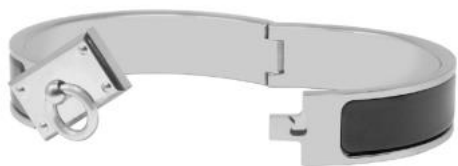

[11] 2015511.5M001

[15] 31-01-2020

[30] 02-08-2019 / EU / 006681607

[51] Cl. 5-06

[54] 紙製品的浮雕圖案

Embossed pattern for paper products

[73] Essity Hygiene and Health Aktiebolag

Mölnåls bro 2,
405 03 Göteborg,
Sweden

[74] DEACONS

5th Floor, Alexandra House,
Central,
Hong Kong

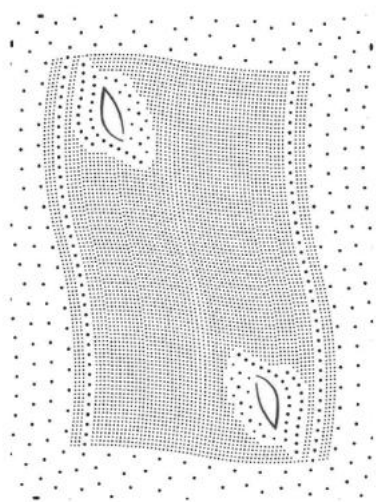

[11] 2015511.5M002

[15] 31-01-2020

[30] 02-08-2019 / EU / 006681607

[51] Cl. 5-06

[54] 紙製品的浮雕圖案

Embossed pattern for paper products

[73] Essity Hygiene and Health Aktiebolag

Mölnbalds bro 2,
405 03 Göteborg,
Sweden

[74] DEACONS

5th Floor, Alexandra House,
Central,
Hong Kong

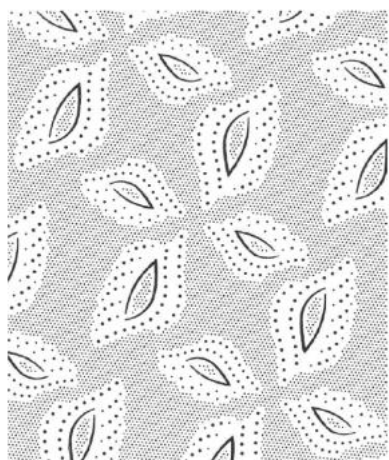

[11] 2015511.5M003

[15] 31-01-2020

[30] 02-08-2019 / EU / 006681607

[51] Cl. 5-06

[54] 紙製品的浮雕圖案

Embossed pattern for paper products

[73] Essity Hygiene and Health Aktiebolag

Mölnbalds bro 2,
405 03 Göteborg,
Sweden

[74] DEACONS

5th Floor, Alexandra House,
Central,
Hong Kong



[11] 2015511.5M004

[15] 31-01-2020

[30] 02-08-2019 / EU / 006681607

[51] Cl. 5-06

[54] 紙製品的浮雕圖案

Embossed Pattern for paper products

[73] Essity Hygiene and Health Aktiebolag

Mölnbals bro 2,
405 03 Göteborg,
Sweden

[74] DEACONS

5th Floor, Alexandra House,
Central,
Hong Kong



[11] 2015511.5M005

[15] 31-01-2020

[30] 02-08-2019 / EU / 006681607

[51] Cl. 5-06

[54] 紙製品的浮雕圖案

Embossed pattern for paper products

[73] Essity Hygiene and Health Aktiebolag
Mölndals bro 2,
405 03 Göteborg,
Sweden

[74] DEACONS
5th Floor, Alexandra House,
Central,
Hong Kong

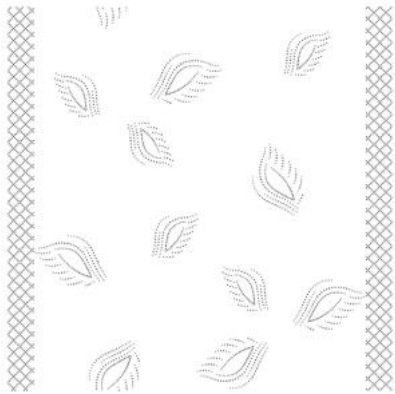

[11] 2015511.5M006

[15] 31-01-2020

[30] 02-08-2019 / EU / 006681607

[51] Cl. 5-06

[54] 紙製品的浮雕圖案

Embossed pattern for paper products

[73] Essity Hygiene and Health Aktiebolag
Mölndals bro 2,
405 03 Göteborg,
Sweden

[74] DEACONS
5th Floor, Alexandra House,
Central,
Hong Kong

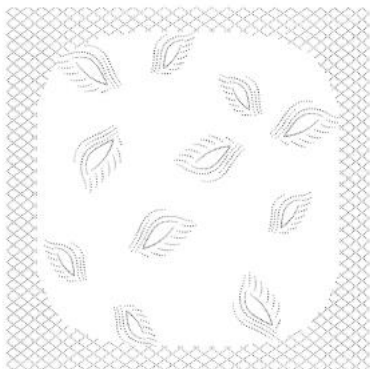

- [11] 2015511.5M007
[15] 31-01-2020
[30] 02-08-2019 / EU / 006681607
[51] Cl. 5-06
[54] 紙製品的浮雕圖案
Embossed pattern for paper products
[73] Essity Hygiene and Health Aktiebolag
Mölndals bro 2,
405 03 Göteborg,
Sweden
[74] DEACONS
5th Floor, Alexandra House,
Central,
Hong Kong



-
- [11] 2015542.0M001
[15] 06-02-2020
[30] 09-08-2019 / EU / 006694220-0001
[51] Cl. 24-02
[54] 醫療儀器、實驗室儀器和工具
Medical instruments, instruments and tools for laboratory use.
[73] SynDermix AG
Buochserstrasse 2,
6370 Stans,
Switzerland
[74] HALDANES
7/F, Ruttonjee House
11 Duddell Street,
Central, Hong Kong

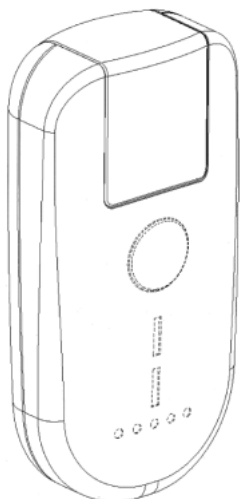

[11] 2015542.0M002

[15] 06-02-2020

[30] 09-08-2019 / EU / 006694220-0002

[51] Cl. 24-02

[54] 醫療儀器、實驗室儀器和工具

Medical instruments, instruments and tools for laboratory use.

[73] SynDermix AG

Buochserstrasse 2,

6370 Stans,

Switzerland

[74] HALDANES

7/F, Ruttonjee House

11 Duddell Street,

Central, Hong Kong

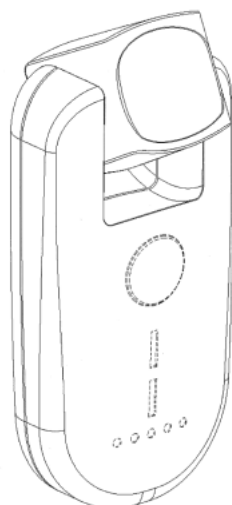

- [11] 2015545.7M001
[15] 06-02-2020
[30] 07-08-2019 / JP / 017623 of 2019
[51] Cl. 9-05
[54] 包裝袋
Packing pouch
[73] 久光製藥株式會社
HISAMITSU PHARMACEUTICAL CO., INC.
408, Tashirodaikan-machi,
Tosu-shi, Saga 841-0017
Japan
[74] WILKINSON & GRIST
6th Floor, Prince's Building,
Chater Road,
Hong Kong



-
- [11] 2015545.7M002
[15] 06-02-2020
[30] 07-08-2019 / JP / 017623 of 2019
[51] Cl. 9-05
[54] 包裝袋
Packing pouch
[73] 久光製藥株式會社
HISAMITSU PHARMACEUTICAL CO., INC.
408, Tashirodaikan-machi,
Tosu-shi, Saga 841-0017
Japan
[74] WILKINSON & GRIST
6th Floor, Prince's Building,
Chater Road,
Hong Kong



[11] 2015545.7M003

[15] 06-02-2020

[30] 07-08-2019 / JP / 017624 of 2019

[51] Cl. 9-05

[54] 包裝袋

Packing pouch

[73] 久光製藥株式會社

HISAMITSU PHARMACEUTICAL CO., INC.

408, Tashirodaikan-machi,

Tosu-shi, Saga 841-0017

Japan

[74] WILKINSON & GRIST

6th Floor, Prince's Building,

Chater Road,

Hong Kong

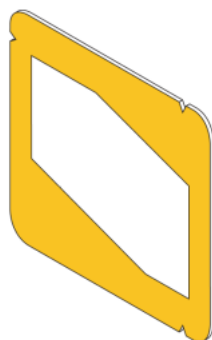

[11] 2015545.7M004

[15] 06-02-2020

[30] 07-08-2019 / JP / 017624 of 2019

[51] Cl. 9-05

[54] 包裝袋

Packing pouch

[73] 久光製藥株式會社

HISAMITSU PHARMACEUTICAL CO., INC.

408, Tashirodaikan-machi,

Tosu-shi, Saga 841-0017

Japan

[74] WILKINSON & GRIST

6th Floor, Prince's Building,

Chater Road,

Hong Kong



[11] 2015545.7M005

[15] 06-02-2020

[30] 07-08-2019 / JP / 017625 of 2019

[51] Cl. 9-05

[54] 包裝袋

Packing pouch

[73] 久光製藥株式會社

HISAMITSU PHARMACEUTICAL CO., INC.

408, Tashirodaikan-machi,

Tosu-shi, Saga 841-0017

Japan

[74] WILKINSON & GRIST

6th Floor, Prince's Building,

Chater Road,

Hong Kong

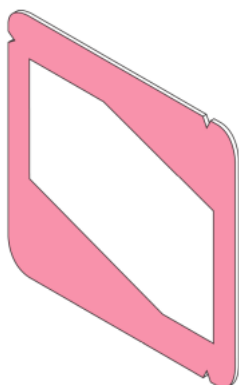

[11] 2015545.7M006

[15] 06-02-2020

[30] 07-08-2019 / JP / 017625 of 2019

[51] Cl. 9-05

[54] 包裝袋

Packing pouch

[73] 久光製藥株式會社

HISAMITSU PHARMACEUTICAL CO., INC.

408, Tashirodaikan-machi,

Tosu-shi, Saga 841-0017

Japan

[74] WILKINSON & GRIST

6th Floor, Prince's Building,

Chater Road,

Hong Kong



[11] 2015545.7M007

[15] 06-02-2020

[30] 07-08-2019 / JP / 017627 of 2019

[51] Cl. 9-05

[54] 包裝盒

Packing box

[73] 久光製藥株式會社

HISAMITSU PHARMACEUTICAL CO., INC.

408, Tashirodaikan-machi,

Tosu-shi, Saga 841-0017

Japan

[74] WILKINSON & GRIST

6th Floor, Prince's Building,

Chater Road,

Hong Kong

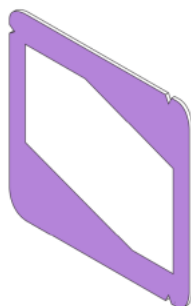

[11] 2015545.7M008

[15] 06-02-2020

[30] 07-08-2019 / JP / 017627 of 2019

[51] Cl. 9-05

[54] 包裝盒

Packing box

[73] 久光製藥株式會社

HISAMITSU PHARMACEUTICAL CO., INC.

408, Tashirodaikan-machi,

Tosu-shi, Saga 841-0017

Japan

[74] WILKINSON & GRIST

6th Floor, Prince's Building,

Chater Road,

Hong Kong



[11] 2015545.7M009

[15] 06-02-2020

[30] 07-08-2019 / JP / 017629 of 2019

[51] C1. 9-05

[54] 包裝袋

Packing pouch

[73] 久光製薬株式会社

HISAMITSU PHARMACEUTICAL CO., INC.

408, Tashirodaikan-machi,

Tosu-shi, Saga 841-0017

Japan

[74] WILKINSON & GRIST

6th Floor, Prince's Building,

Chater Road,

Hong Kong

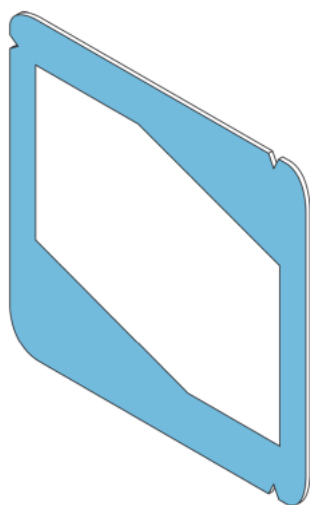

-
- [11] 2015545.7M010
[15] 06-02-2020
[30] 07-08-2019 / JP / 017629 of 2019
[51] Cl. 9-05
[54] 包裝袋
Packing pouch
[73] 久光製藥株式會社
HISAMITSU PHARMACEUTICAL CO., INC.
408, Tashirodaikan-machi,
Tosu-shi, Saga 841-0017
Japan
[74] WILKINSON & GRIST
6th Floor, Prince's Building,
Chater Road,
Hong Kong



-
- [11] 2015545.7M011
[15] 06-02-2020
[30] 15-11-2019 / JP / 025409 of 2019
[51] Cl. 9-03
[54] 包裝盒
Packing box
[73] 久光製藥株式會社
HISAMITSU PHARMACEUTICAL CO., INC.
408, Tashirodaikan-machi,
Tosu-shi, Saga 841-0017
Japan
[74] WILKINSON & GRIST
6th Floor, Prince's Building,

Chater Road,
Hong Kong

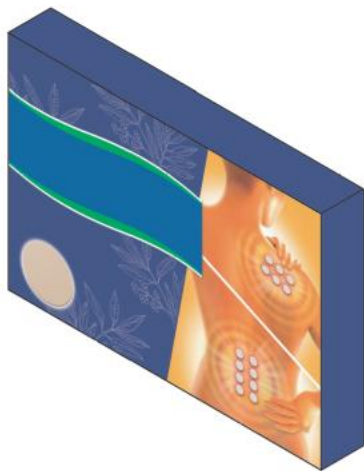

[11] 2015545.7M012

[15] 06-02-2020

[30] 15-11-2019 / JP / 025409 of 2019

[51] Cl. 9-05

[54] 包裝盒
Packing box

[73] 久光製藥株式會社
HISAMITSU PHARMACEUTICAL CO., INC.
408, Tashirodaikan-machi,
Tosu-shi, Saga 841-0017
Japan

[74] WILKINSON & GRIST
6th Floor, Prince's Building,
Chater Road,
Hong Kong



[11] 2015545.7M013

[15] 06-02-2020

[30] 29-08-2019 / JP / 019254 of 2019

[51] Cl. 9-01

[54] 噴霧器

Spray container

[73] 久光製藥株式會社

HISAMITSU PHARMACEUTICAL CO., INC.

408, Tashirodaikan-machi,

Tosu-shi, Saga 841-0017

Japan

[74] WILKINSON & GRIST

6th Floor, Prince's Building,

Chater Road,

Hong Kong



[11] 2015574.7

[15] 12-02-2020

[51] Cl. 9-03

[54] 包裝外盒

Packaging box

[73] Europharm Laboratoires (Hong Kong) Company Limited

G/F 1/F Flat A & Flat B 4/F, Complex 1, 5 Dai Fu Street, Tai

Po Industrial Estate, Tai Po, New Territories,

HONG KONG

[74] SPRUSON & FERGUSON (HONG KONG) LIMITED

5001 Hopewell Centre

183 Queen's Road East,
Wan Chai, Hong Kong

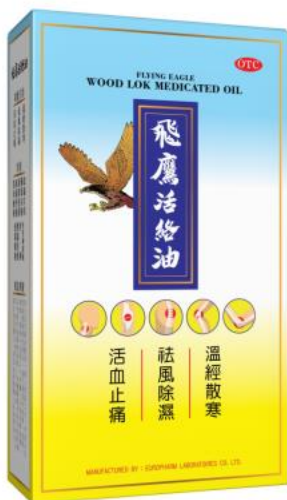

[11] 2015610.5M001

[15] 14-02-2020

[51] Cl. 23-01

[54] 排水口的漏斗

Funnel for drainage

[73] 香港創新立體印刷有限公司

I3D Printer (HK) Limited

香港新浦崗

五芳街 12 號

利景工業大廈 3 樓 A05 室

[74] CTR PRODUCT DEVELOPMENT LIMITED

香港九龍

九龍灣宏光道 8 號

創豪坊 7 樓 706 室

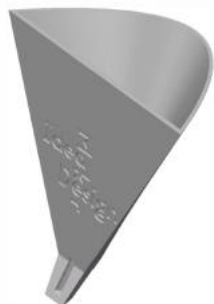

- [11] 2015610.5M002
- [15] 14-02-2020
- [51] Cl. 23-01
- [54] 排水口的漏斗
Funnel for drainage
- [73] 香港創新立體印刷有限公司
I3D Printer (HK) Limited
香港新浦崗
五芳街 12 號
利景工業大廈 3 樓 A05 室
- [74] CTR PRODUCT DEVELOPMENT LIMITED
香港九龍
九龍灣宏光道 8 號
創豪坊 7 樓 706 室



-
- [11] 2015631.9
 - [15] 18-02-2020
 - [30] 23-09-2019 / CH / 144897
 - [51] Cl. 7-02
 - [54] 飲料分配機
Beverage dispenser
 - [73] Société des Produits Nestlé S.A.
1800 Vevey,
SWITZERLAND
 - [74] DEACONS
5th Floor, Alexandra House,
Central,
Hong Kong



[11] 2015632.1M001

[15] 18-02-2020

[30] 22-11-2019 / AM, AZ, BZ, BA, GE, LI, MK, MD, MC, MN, ME, NO, OM, SG, CH, TN, TR, UA, GB, EU, AL, KG / DM/204 981

[51] Cl. 10-07

[54] 錶面
Dial

[73] MONTRES JAQUET DROZ SA (MONTRES JAQUET DROZ AG) (MONTRES JAQUET DROZ LTD.)
Allée du Tourbillon 2,
CH-2300 La Chaux-de-Fonds,
SWITZERLAND

[74] SPRUSON & FERGUSON (HONG KONG) LIMITED
5001 Hopewell Centre
183 Queen's Road East,
Wan Chai, Hong Kong

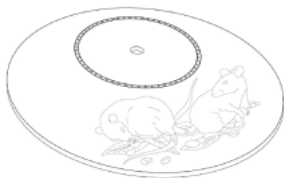

[11] 2015632.1M002

[15] 18-02-2020

[30] 22-11-2019 / AM, AZ, BZ, BA, GE, LI, MK, MD, MC, MN, ME, NO, OM, SG, CH, TN, TR, UA, GB, EU, AL, KG / DM/204 981

[51] Cl. 10-07

[54] 自動盤
Oscillating weight

[73] MONTRES JAQUET DROZ SA (MONTRES JAQUET DROZ AG) (MONTRES JAQUET DROZ LTD.)
Allée du Tourbillon 2,
CH-2300 La Chaux-de-Fonds,
SWITZERLAND

[74] SPRUSON & FERGUSON (HONG KONG) LIMITED
5001 Hopewell Centre
183 Queen's Road East,
Wan Chai, Hong Kong

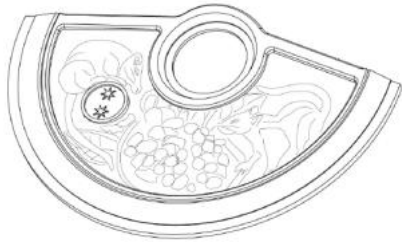

[11] 2015632.1M003

[15] 18-02-2020

[30] 22-11-2019 / AM, AZ, BZ, BA, GE, LI, MK, MD, MC, MN, ME, NO,
OM, SG, CH, TN, TR, UA, GB, EU, AL, KG / DM/204 981

[51] Cl. 10-07

[54] 錶面
Dial

[73] MONTRES JAQUET DROZ SA (MONTRES JAQUET DROZ AG) (MONTRES JAQUET DROZ LTD.)
Allée du Tourbillon 2,
CH-2300 La Chaux-de-Fonds,
SWITZERLAND

[74] SPRUSON & FERGUSON (HONG KONG) LIMITED
5001 Hopewell Centre
183 Queen's Road East,
Wan Chai, Hong Kong



- [11] 2015632.1M004
- [15] 18-02-2020
- [30] 22-11-2019 / AM, AZ, BZ, BA, GE, LI, MK, MD, MC, MN, ME, NO, OM, SG, CH, TN, TR, UA, GB, EU, AL, KG / DM/204 981
- [51] Cl. 10-07
- [54] 自動盤
Oscillating weight
- [73] MONTRES JAQUET DROZ SA (MONTRES JAQUET DROZ AG) (MONTRES JAQUET DROZ LTD.)
Allée du Tourbillon 2,
CH-2300 La Chaux-de-Fonds,
SWITZERLAND
- [74] SPRUSON & FERGUSON (HONG KONG) LIMITED
5001 Hopewell Centre
183 Queen's Road East,
Wan Chai, Hong Kong

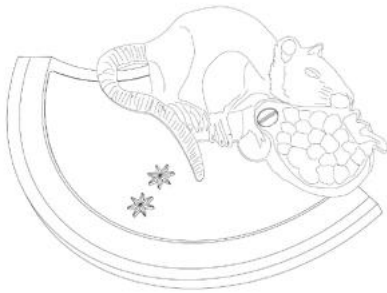

-
- [11] 2015633.3M001
- [15] 18-02-2020
- [30] 21-08-2019 / EU / 006740569-0001
- [51] Cl. 20-03
Cl. 20-02
- [54] 用於銷售、展示和廣告的吉祥物
Mascot for sales, display and advertisement
- [73] Save the Duck S.p.A.
Via Arcivescovo Calabiana, 6
20139 Milano,
ITALY
- [74] CLT PATENT & TRADEMARK (H.K.) LIMITED
Unit 09, 34/F., Office Tower, Convention Plaza,
No. 1 Harbour Road,
Wanchai, Hong Kong



[11] 2015633.3M002

[15] 18-02-2020

[30] 21-08-2019 / EU / 006740569-0002

[51] Cl. 20-03

Cl. 20-02

[54] 用於銷售、展示和廣告的吉祥物

Mascot for sales, display and advertisement

[73] Save the Duck S.p.A.

Via Arcivescovo Calabiana, 6

20139 Milano,

ITALY

[74] CLT PATENT & TRADEMARK (H.K.) LIMITED

Unit 09, 34/F., Office Tower, Convention Plaza,

No. 1 Harbour Road,

Wanchai, Hong Kong



- [11] 2015634.5
[15] 19-02-2020
[30] 11-09-2019 / CN / 201930499756.9
[51] Cl. 7-02
[54] 電飯煲
Electric rice cooker
[73] 北京小米移動軟件有限公司
Beijing Xiaomi Mobile Software Co., Ltd.
中國內地
北京市海澱區西二旗中路 33 號院
6 號樓 8 層 018 號
[74] 隆天專利商標代理有限公司
香港長沙灣
青山道 485 號
九龍廣場 10 樓 11 室



-
- [11] 2015635.8
[15] 19-02-2020
[51] Cl. 10-04
[54] 紅外線探熱器
Infrared thermometer
[73] 展圖生物科技有限公司
SUPREMIUM BIO-TECHNOLOGY LIMITED
香港葵涌
華星街 12-14 號
華星工業大廈 19 樓 01 室
[74] 展圖生物科技有限公司
香港葵涌
華星街 12-14 號
華星工業大廈 19 樓 01 室



[11] 2015636.0M001

[15] 19-02-2020

[30] 25-10-2019 / EP / 007112669-0001

[51] Cl. 7-06

[54] 夾子
Tong

[73] Brabantia Nederland B.V.
De Haak 14,
NL-5555 XK Valkenswaard,
PAÍSES BAJOS,
NETHERLANDS

[74] NTD PATENT & TRADE MARK AGENCY LIMITED
Units 1805-6, 18/F.,
Greenfield Tower, Concordia Plaza,
No. 1 Science Museum Road,
Tsimshatsui East, Kowloon, Hong Kong

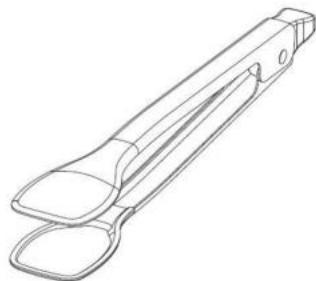

- [11] 2015636.0M002
[15] 19-02-2020
[30] 29-10-2019 / EP / 007134986-0001
[51] Cl. 7-04
[54] 廚房用具手柄
Handle for kitchen utensil
[73] Brabantia Nederland B.V.
De Haak 14,
NL-5555 XK Valkenswaard,
PAÍSES BAJOS,
NETHERLANDS
[74] NTD PATENT & TRADE MARK AGENCY LIMITED
Units 1805-6, 18/F.,
Greenfield Tower, Concordia Plaza,
No. 1 Science Museum Road,
Tsimshatsui East, Kowloon, Hong Kong



-
- [11] 2015638.4M001
[15] 20-02-2020
[30] 17-09-2019 / EU / 006874558-0001
17-09-2019 / GB / 6071196
[51] Cl. 17-01
[54] 聲音合成器
Synthesizer
[73] Focusrite Audio Engineering Limited
Windsor House Turnpike Road,
High Wycombe,
Buckinghamshire HP12 3FX,
UNITED KINGDOM
[74] CHAN, TANG & KWOK
Rooms 2503-04, 25/F.,
Shanghai Industrial Investment Building,
48-62 Hennessy Road,
Wanchai, Hong Kong

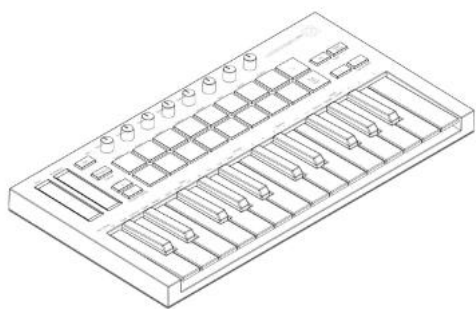

[11] 2015638.4M002

[15] 20-02-2020

[30] 17-09-2019 / GB / 6071197
17-09-2019 / EU / 006874558-0002

[51] Cl. 17-01

[54] 聲音合成器
Synthesizer

[73] Focusrite Audio Engineering Limited
Windsor House Turnpike Road,
High Wycombe,
Buckinghamshire HP12 3FX,
UNITED KINGDOM

[74] CHAN, TANG & KWOK
Rooms 2503-04, 25/F.,
Shanghai Industrial Investment Building,
48-62 Hennessy Road,
Wanchai, Hong Kong



[11] 2015639.6M001

[15] 20-02-2020

[30] 21-08-2019 / CN / 201930456595.5

[51] Cl. 14-04

- [54] 手機的圖形用戶界面
Graphical user interface for mobile phone
- [73] 騰訊科技（深圳）有限公司
TENCENT TECHNOLOGY (SHENZHEN) COMPANY LIMITED
中國內地
廣東省深圳市南山區
高新區科技中一路
騰訊大廈 35 層
- [74] 集佳知識產權有限公司
香港九龍
旺角洗衣街 39-55 號
金雞廣場 12 層 1201 室



-
- [11] 2015639.6M002
- [15] 20-02-2020
- [30] 21-08-2019 / CN / 201930456595.5
- [51] C1. 14-04
- [54] 手機的圖形用戶界面
Graphical user interface for mobile phone
- [73] 騰訊科技（深圳）有限公司
TENCENT TECHNOLOGY (SHENZHEN) COMPANY LIMITED
中國內地
廣東省深圳市南山區
高新區科技中一路
騰訊大廈 35 層
- [74] 集佳知識產權有限公司
香港九龍
旺角洗衣街 39-55 號
金雞廣場 12 層 1201 室



[11] 2015639.6M003

[15] 20-02-2020

[30] 21-08-2019 / CN / 201930456595.5

[51] Cl. 14-04

[54] 手機的圖形用戶界面

Graphical user interface for mobile phone

[73] 騰訊科技（深圳）有限公司

TENCENT TECHNOLOGY (SHENZHEN) COMPANY LIMITED

中國內地

廣東省深圳市南山區

高新區科技中一路

騰訊大廈 35 層

[74] 集佳知識產權有限公司

香港九龍

旺角洗衣街 39-55 號

金雞廣場 12 層 1201 室



[11] 2015640.8

[15] 20-02-2020

[51] Cl. 9-01

[54] 飲料瓶

Drinking bottle

[73] MASTER PLANS LLC

310 Alder Road, Dover,
Kent, Delaware 19904,
UNITED STATES

[74] Wenping Patent & Trade Mark Agent Limited

1701 Tung Wai Commercial Building,
111 Gloucester Road,
Hong Kong

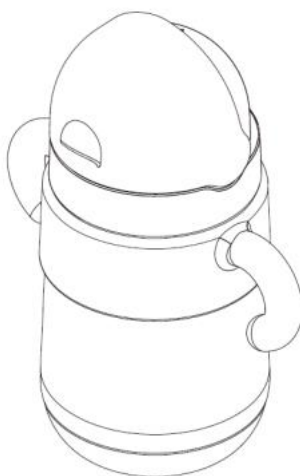

[11] 2015641.0M001

[15] 21-02-2020

[51] Cl. 21-01

[54] 一套玩偶

A set of doll

[73] 眾安科技（國際）集團有限公司

ZHONGAN TECHNOLOGIES INTERNATIONAL GROUP LIMITED

香港

數碼港道 100 號

數碼港 3 座資訊科技大道

13 樓 1301-05 室

[74] 卓遠知識產權有限公司

香港上環

禧利街 27 號

富輝商業中心 10 樓

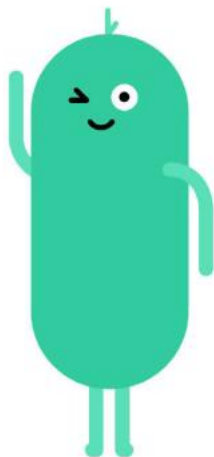

[11] 2015641.0M002

[15] 21-02-2020

[51] Cl. 21-01

[54] 一套玩偶

A set of doll

[73] 眾安科技（國際）集團有限公司

ZHONGAN TECHNOLOGIES INTERNATIONAL GROUP LIMITED

香港

數碼港道 100 號

數碼港 3 座資訊科技大道

13 樓 1301-05 室

[74] 卓遠知識產權有限公司

香港上環

禧利街 27 號
富輝商業中心 10 樓



-
- [11] 2015642.2
[15] 21-02-2020
[51] Cl. 8-07
[54] 智能鎖
Smart lock
[73] 威明金屬製品廠有限公司
WAI MING METAL MANUFACTURER LIMITED
Unit 5, 7/F, Seaview Centre,
139-141 Hoi Bun Road,
Kwun Tong, Kowloon,
Hong Kong
[74] Messrs. Chow & Ho, Solicitors
Rooms 2102-03, 21/F, 299 QRC,
287-299 Queen's Road Central,
Hong Kong

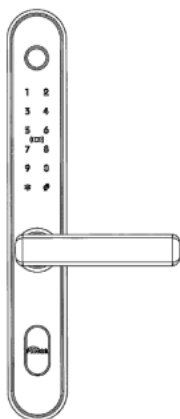

-
- [11] 2015643.4

- [15] 21-02-2020
- [30] 13-09-2019 / MC, CH, EU / DM/203 371
- [51] Cl. 26-05
- [54] 燈
Lamp
- [73] 卡泰拉尼&史密斯有限公司
CATELLANI & SMITH S.r.L
Via Cimitero,
1/A I-24020 - VILLA DI SERIO (Bergamo),
ITALY
- [74] LUNG TIN PATENT TRADEMARK AGENT LIMITED
Flat 11, 10/F Kowloon Plaza,
485 Castle Peak Road,
Cheung Sha Wan, Hong Kong



-
- [11] 2015644.6
- [15] 21-02-2020
- [51] Cl. 10-01
- [54] 多媒體播放器
Multi media player
- [73] 梁偉雄
LEUNG WAI HUNG
香港香港仔
奇力灣嘉隆苑
嘉平閣七樓六室
- [74] 梁偉雄
香港香港仔
奇力灣嘉隆苑
嘉平閣七樓六室

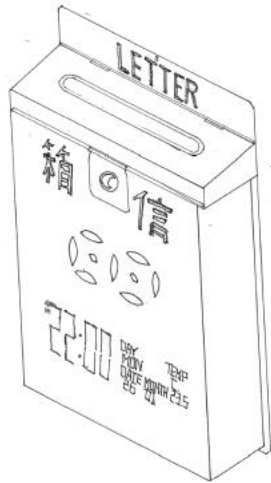

[11] 2015645.9M001

[15] 21-02-2020

[51] Cl. 11-01

[54] 飾物設計

Ornament design

[73] 六福集團有限公司

Luk Fook Holdings Company Limited
Floor 15, 20, 25 & 27, Metropole Square,
No.2 On Yiu Street,
Shatin, New Territories, Hong Kong

[74] Luk Fook Holdings Company Limited (Legal Affairs Department)

Floor 25, Metropole Square,
No.2 On Yiu Street,
Shatin, New Territories, Hong Kong



[11] 2015645.9M002

[15] 21-02-2020

[51] Cl. 11-01

[54] 飾物設計

Ornament design

[73] 六福集團有限公司

Luk Fook Holdings Company Limited
Floor 15, 20, 25 & 27, Metropole Square,
No.2 On Yiu Street,
Shatin, New Territories, Hong Kong

[74] Luk Fook Holdings Company Limited (Legal Affairs Department)

Floor 25, Metropole Square,
No.2 On Yiu Street,
Shatin, New Territories, Hong Kong



[11] 2015647.3

[15] 21-02-2020

[51] Cl. 29-02

[54] 布口罩

Fabric mask

[73] 林麗霞

LAM LAI HA ANITA
Room 2, 5/F.,
36 Shung Ling Street,
San Po Kong, Kowloon, Hong Kong

[74] LAM LAI HA ANITA

Room 2, 5/F.,
36 Shung Ling Street,
San Po Kong, Kowloon, Hong Kong



[11] 2015648.5

[15] 21-02-2020

[51] Cl. 11-01

[54] 項鍊

Necklace

[73] 新豐珠寶有限公司

Sunny Creations Ltd.

Suite 1003-4, Hilder Centre,

2 Sung Ping Street,

Hung Hom, Kowloon,

Hong Kong

[74] FAIRBAIRN CATLEY LOW & KONG

23/F, Shui On Centre

6-8 Harbour Road,

Wanchai. Hong Kong



[11] 2015649.7

[15] 24-02-2020

[30] 02-10-2019 / DE / 402019101088.2

[51] Cl. 21-01

[54] 玩具車

Toy vehicle

[73] VOLKSWAGEN AKTIENGESELLSCHAFT

38436 WOLFSBURG,

GERMANY

[74] CHINA PATENT AGENT (HONG KONG) LIMITED

22/F, Great Eagle Centre,

23 Harbour Road,

Wanchai, Hong Kong



[11] 2015650.9M001

[15] 24-02-2020

[30] 02-10-2019 / DE / 402019101088.2

[51] Cl. 12-08

[54] 汽車

Motor vehicle

[73] VOLKSWAGEN AKTIENGESELLSCHAFT

38436 WOLFSBURG,

GERMANY

[74] CHINA PATENT AGENT (HONG KONG) LIMITED

22/F, Great Eagle Centre,

23 Harbour Road,

Wanchai, Hong Kong



- [11] 2015650.9M002
[15] 24-02-2020
[30] 02-10-2019 / DE / 402019101088.2
[51] C1. 12-08
[54] 汽車
Motor vehicle
[73] VOLKSWAGEN AKTIENGESELLSCHAFT
38436 WOLFSBURG,
GERMANY
[74] CHINA PATENT AGENT (HONG KONG) LIMITED
22/F, Great Eagle Centre,
23 Harbour Road,
Wanchai, Hong Kong



- [11] 2015650.9M003
[15] 24-02-2020
[30] 02-10-2019 / DE / 402019101088.2
[51] C1. 12-08
[54] 汽車
Motor vehicle
[73] VOLKSWAGEN AKTIENGESELLSCHAFT
38436 WOLFSBURG,
GERMANY
[74] CHINA PATENT AGENT (HONG KONG) LIMITED
22/F, Great Eagle Centre,
23 Harbour Road,
Wanchai, Hong Kong



[11] 2015651.1

[15] 24-02-2020

[51] Cl. 9-07

[54] 瓶蓋

Lid for bottle

[73] 李錦記有限公司

LEE KUM KEE COMPANY LTD

香港新界

大埔工業村

大發街 2 至 4 號

[74] 香港知識產權代理有限公司

香港新界白石角

香港科學園第三期

科技大道西 12 號 2 樓 230 室



[11] 2015652.3

[15] 24-02-2020

[30] 23-08-2019 / US / 29/703,005

[51] Cl. 9-01

[54] 瓶

Bottle

[73] 寶潔公司

THE PROCTER & GAMBLE COMPANY
One Procter & Gamble Plaza,
Cincinnati, OH 45202,
UNITED STATES

[74] SHANGHAI INTELLECTUAL PROPERTY OFFICE

Unit F, 20th Floor, Neich Tower,
128 Gloucester Road,
Hong Kong

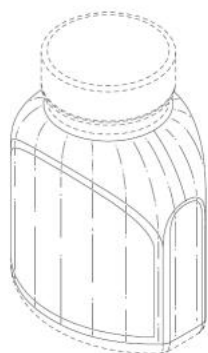

[11] 2015653.5

[15] 24-02-2020

[30] 30-08-2019 / AM, BA, GE, MK, MD, ME, MA, SG, CH, TN, TR, GB,
EU, AL / DM/203 513

[51] Cl. 10-02

[54] 錶

Watch

[73] TISSOT SA (TISSOT AG) (TISSOT LTD)

Chemin des Tourelles 17,
CH-2400 Le Locle,
SWITZERLAND

[74] SPRUSON & FERGUSON (HONG KONG) LIMITED

5001 Hopewell Centre
183 Queen's Road East,
Wan Chai, Hong Kong



-
- [11] 2015654.7
[15] 24-02-2020
[30] 26-08-2019 / JP / 018912 of 2019
[51] Cl. 28-03
[54] 吹風機
Hair dryer
[73] 株式會社 MTG
MTG Co., Ltd.
32, HONJIN-DORI 2-CHOME,
NAKAMURA-KU, NAGOYA-SHI,
AICHI-KEN 453-0041
JAPAN
[74] CHINAHONGKONG IP LIMITED
3011, 30/F, Office Tower,
Convention Plaza,
1 Harbour Road, Hong Kong



-
- [11] 2015655.0
[15] 24-02-2020

[30] 26-08-2019 / JP / 018913 of 2019

[51] Cl. 28-03

[54] 卷髮棒

Hair iron

[73] 株式會社 MTG

MTG Co., Ltd.

32, HONJIN-DORI 2-CHOME,

NAKAMURA-KU, NAGOYA-SHI,

AICHI-KEN 453-0041

JAPAN

[74] CHINAHONGKONG IP LIMITED

3011, 30/F, Office Tower,

Convention Plaza,

1 Harbour Road, Hong Kong



[11] 2015656.2M001

[15] 24-02-2020

[30] 22-08-2019 / US / 29/702,965

[51] Cl. 9-07

[54] 用於儲存容器的蓋子

Lid for a storage container

[73] 美亞知識產權有限公司

Meyer Intellectual Properties Limited

382 Kwun Tong Road,

Kowloon,

Hong Kong

[74] CHANG TSI AND PARTNERS INTELLECTUAL PROPERTY (HK) LIMITED

Level 19 Two Int'l Finance Ctr

8 Finance St,

Central, Hong Kong



[11] 2015656.2M002

[15] 24-02-2020

[30] 22-08-2019 / US / 29/702,965

[51] Cl. 9-07

[54] 用於儲存容器的蓋子

Lid for a storage container

[73] 美亞知識產權有限公司

Meyer Intellectual Properties Limited

382 Kwun Tong Road,

Kowloon,

Hong Kong

[74] CHANG TSI AND PARTNERS INTELLECTUAL PROPERTY (HK) LIMITED

Level 19 Two Int'l Finance Ctr

8 Finance St,

Central, Hong Kong

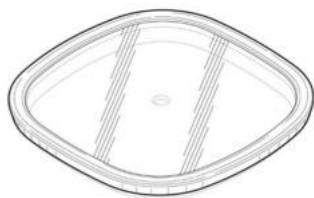

[11] 2015656.2M003

[15] 24-02-2020

[30] 22-08-2019 / US / 29/702,965

[51] Cl. 9-07

[54] 用於儲存容器的蓋子

Lid for a storage container

[73] 美亞知識產權有限公司

Meyer Intellectual Properties Limited

382 Kwun Tong Road,

Kowloon,
Hong Kong

- [74] CHANG TSI AND PARTNERS INTELLECTUAL PROPERTY (HK) LIMITED
Level 19 Two Int'l Finance Ctr
8 Finance St,
Central, Hong Kong



-
- [11] 2015657.4M001
[15] 24-02-2020
[30] 22-08-2019 / US / 29/702,969
[51] Cl. 9-07
[54] 用於儲存容器的蓋子
Lid for a storage container
[73] 美亞知識產權有限公司
Meyer Intellectual Properties Limited
382 Kwun Tong Road,
Kowloon,
Hong Kong
[74] CHANG TSI AND PARTNERS INTELLECTUAL PROPERTY (HK) LIMITED
Level 19 Two Int'l Finance Ctr
8 Finance St,
Central Hong Kong
Hong Kong

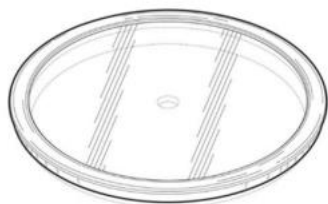

[11] 2015657.4M002

[15] 24-02-2020

[30] 22-08-2019 / US / 29/702,969

[51] Cl. 9-07

[54] 用於儲存容器的蓋子

Lid for a storage container

[73] 美亞知識產權有限公司

Meyer Intellectual Properties Limited

382 Kwun Tong Road,

Kowloon,

Hong Kong

[74] CHANG TSI AND PARTNERS INTELLECTUAL PROPERTY (HK) LIMITED

Level 19 Two Int'l Finance Ctr

8 Finance St,

Central Hong Kong

Hong Kong

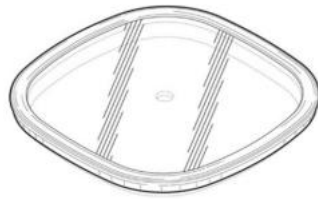

[11] 2015657.4M003

[15] 24-02-2020

[30] 22-08-2019 / US / 29/702,969

[51] Cl. 9-07

[54] 用於儲存容器的蓋子

Lid for a storage container

[73] 美亞知識產權有限公司

Meyer Intellectual Properties Limited

382 Kwun Tong Road,

Kowloon,

Hong Kong

[74] CHANG TSI AND PARTNERS INTELLECTUAL PROPERTY (HK) LIMITED

Level 19 Two Int'l Finance Ctr

8 Finance St,

Central Hong Kong

Hong Kong

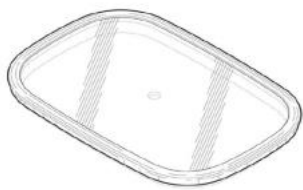

[11] 2015658.6

[15] 24-02-2020

[51] Cl. 16-06

[54] 太陽眼鏡
Sunglasses

[73] CHRISTIAN DIOR COUTURE
30 Avenue Montaigne,
75008 Paris,
FRANCE

[74] WILKINSON & GRIST
6th Floor, Prince's Building,
Chater Road,
Hong Kong



[11] 2015661.2

[15] 25-02-2020

[51] Cl. 7-05

[54] 熨斗
Garment steamer

- [73] 廣東天物新材料科技有限公司
Guangdong Flexwarm Advanced Materials & Technology Co., Ltd.
中國內地
廣州市番禺區沙灣鎮
紫坭村西安路 7 號 (辦公大樓)
- [74] 香港專利商標代理有限公司
香港
皇后大道西 419K
博仕臺 10 樓 A 室



-
- [11] 2015662.4
[15] 25-02-2020
[30] 28-08-2019 / EU / 006776910-0001
[51] Cl. 7-02
[54] 平底鍋手柄
Pan lifter
[73] CRISTEL
Parc d'Activite du Moulin,
F-25490 Fesches-le-Chatel,
FRANCE
[74] HONG KONG UTC INTELLECTUAL PROPERTY (HOLDINGS) LIMITED
1105, 11/F, Tower Two, Lippo Centre,
89 Queensway,
Hong Kong



-
- [11] 2015663.6M001
[15] 26-02-2020
[30] 03-09-2019 / DE / 402019100944.2
[51] Cl. 21-01
[54] 玩具或比例模型車
Toy or scale model vehicle
[73] Bayerische Motoren Werke Aktiengesellschaft
Petuelring 130,
80809 Muenchen,
GERMANY
[74] HASTINGS & CO
5/F Gloucester Tower, The Landmark,
11 Pedder Street,
Central, Hong Kong



-
- [11] 2015663.6M002
[15] 26-02-2020
[30] 03-09-2019 / DE / 402019100944.2
[51] Cl. 21-01

[54] 玩具或比例模型車

Toy or scale model vehicle

[73] Bayerische Motoren Werke Aktiengesellschaft

Petuelring 130,

80809 Muenchen,

GERMANY

[74] HASTINGS & CO

5/F Gloucester Tower, The Landmark,

11 Pedder Street,

Central, Hong Kong



[11] 2015663.6M003

[15] 26-02-2020

[30] 03-09-2019 / DE / 402019100944.2

[51] Cl. 21-01

[54] 玩具或比例模型車

Toy or scale model vehicle

[73] Bayerische Motoren Werke Aktiengesellschaft

Petuelring 130,

80809 Muenchen,

GERMANY

[74] HASTINGS & CO

5/F Gloucester Tower, The Landmark,

11 Pedder Street,

Central, Hong Kong



[11] 2015665.1

- [15] 26-02-2020
- [30] 09-12-2019 / CN / 201930684844.6
- [51] Cl. 16-02
- [54] 投影機
Projector
- [73] 深圳光峰科技股份有限公司
中國內地
廣東省深圳市南山區
粵海街道學府路 63 號
高新區聯合總部大廈 20-22 樓
- [74] 景福智慧顧問有限公司
香港銅鑼灣
軒尼詩道 489 道
銅鑼灣廣場 I 期 22 樓 2202 室

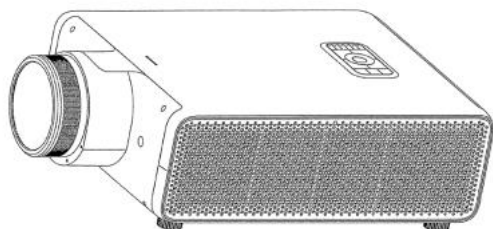

-
- [11] 2015666.3M001
- [15] 26-02-2020
- [51] Cl. 6-01
- [54] 戶外編藤椅子
Outdoor rattan chair
- [73] Tropical Outdoor Company Limited
Unit 1001, Westley Square,
48 Hoi Yuen Road,
Kwun Tong, Hong Kong
- [74] Tropical Outdoor Company Limited
Unit 1001, Westley Square,
48 Hoi Yuen Road,
Kwun Tong



[11] 2015666.3M002

[15] 26-02-2020

[51] Cl. 6-01

[54] 戶外編藤椅子

Outdoor rattan chair

[73] Tropical Outdoor Company Limited

Unit 1001, Westley Square,

48 Hoi Yuen Road,

Kwun Tong, Hong Kong

[74] Tropical Outdoor Company Limited

Unit 1001, Westley Square,

48 Hoi Yuen Road,

Kwun Tong



[11] 2015667.5

[15] 26-02-2020

[51] Cl. 9-03

[54] 可折疊容器

Foldable container

[73] Plastmetic (Hong Kong) Manufactory Limited

Unit 12, 18/F., Rear Block,
Wah Fat Industrial Building,
10-14 Kung Yip Street, Kwai Chung,
New Territories, Hong Kong

[74] CHAN, TANG & KWOK

Rooms 2503-04, 25/F.,
Shanghai Industrial Investment Building,
48-62 Hennessy Road,
Wanchai, Hong Kong

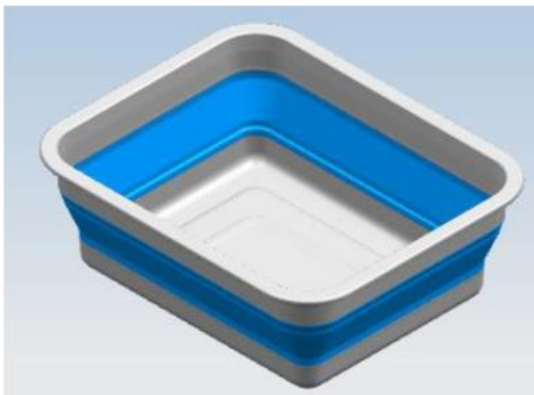



香港特別行政區政府知識產權署外觀設計註冊處

The Government of the Hong Kong Special Administrative Region

Designs Registry, Intellectual Property Department

根據註冊外觀設計條例第 28 條，下列註冊外觀設計因未繳續期費而停止有效。

各組記項按註冊外觀設計停止有效日期及註冊編號先後次序排列。

Registered designs ceased through non-payment of renewal fees under section 28 of the Registered Designs Ordinance. Entries are listed below under their expiry dates.

14-05-2020 - 20-05-2020

14-05-2020	0501143.8	1501084.4M002
1501049.1	0501144.0M001	1501086.9
1501050.3M001	0501144.0M002	1501087.1
1501050.3M002	0501144.0M003	1501088.3M001
1501052.7	0501144.0M004	1501088.3M002
1501053.9	0501144.0M005	1501088.3M003
1501055.4	0501144.0M006	1501088.3M005
1501056.6	0501144.0M007	1501088.3M006

	0501144.0M008	1501088.3M007
15-05-2020	0501144.0M009	1501088.3M008
1501060.4	1000922.7	1501088.3M009
	1000923.9	1501088.3M010

17-05-2020	1000924.1	1501088.3M011
1000909.0	1000925.4	1501088.3M012
1000911.4M001	1000926.6	1501088.3M013
1000911.4M002	1000927.8	1501088.3M014
1000911.4M003	1000928.0	1501089.5
1000911.4M004	1000929.2	1501090.7
1000911.4M005	1000930.4	
1000911.4M006	1000931.6	
1000911.4M007	1000932.8	
1000912.6	1501069.3	
1000915.3M005	1501071.7	
1501063.0	1501073.1	
1501067.9M001	1501074.3	
1501067.9M002		
1501067.9M003	19-05-2020	
1501067.9M004	0501181.8	
	1501078.2	

18-05-2020	1501079.4	
0010610.6M001	1501080.6	

0010610.6M002		
0010610.6M003	20-05-2020	
0501060.2	1501084.4M001	



香港特別行政區政府知識產權署外觀設計註冊處

The Government of the Hong Kong Special Administrative Region

Designs Registry, Intellectual Property Department

根據註冊外觀設計規則第 31 條刪除的註冊外觀設計。各組記項按註冊外觀設計刪除日期及註冊編號先後次序排列。

Registered designs removed under section 31 of the Registered Designs Rules. Entries are listed below under their removal dates.

27-06-2020 - 02-07-2020

27-06-2020	1402128.9M002
0412584.5M003	1402128.9M003
0901924.9	1402128.9M004
	1402128.9M005

28-06-2020

0412607.6M001	01-07-2020
0412607.6M002	1402130.3M001
0412607.6M003	1402130.3M002
0412607.6M004	1402130.3M003
0412607.6M005	1402130.3M004
0412607.6M006	1402134.1M001
0412607.6M007	1402134.1M002
0412607.6M008	1402137.8
0412607.6M009	1402138.0

0412607.6M010

0412607.6M011

0412607.6M012

0901927.6

0901934.0M001

0901934.0M002

1402117.6

1402119.0

02-07-2020

1402139.2M001

1402139.2M002

1402141.6

1402142.8

1402143.0

1402146.7M001

1402146.7M002

29-06-2020

0901938.9M001

0901938.9M002

1402120.2M001

1402120.2M002

1402120.2M003

1402122.6

30-06-2020

1402127.7

1402128.9M001



香港特別行政區政府知識產權署外觀設計註冊處
The Government of the Hong Kong Special Administrative Region
Designs Registry, Intellectual Property Department

已在官方公報刊登的外觀設計公告內的表述更正如下：

The following show the corrected representations of the designs in advertisement previously published in the official journal:

官方公報日期 Official journal date 03.01.2020

[11] 1914171.8M005

[55] 外觀設計的表述 Representation of the Design

