

香港知識產權公報

Hong Kong Intellectual Property Journal

2020年9月18日
18 September 2020



目錄 Contents

根據註冊外觀設計條例第 25 條註冊的外觀設計

Designs Registered under section 25 of the Registered Designs Ordinance

按註冊編號排列

Arranged by Registration Number

根據註冊外觀設計條例(第 522 章)公布的其他公告

Other Notices Published under the Registered Designs Ordinance (Cap. 522)

根據註冊外觀設計條例第 28 條，註冊外觀設計因未繳續期費而停止有效

Registered designs ceased through non-payment of renewal fees under section 28 of the Registered Designs Ordinance

根據註冊外觀設計規則第 31 條刪除的註冊外觀設計

Registered designs removed under section 31 of the Registered Designs Rules

勘誤

Corrigendum

以下事項沒有記錄

No Records for the Following Matters

根據註冊外觀設計條例第 30 條放棄的外觀設計的註冊

Surrender of Registration of Design under section 30 of the Registered Designs Ordinance

根據註冊外觀設計規則第 37 條，向處長作出轉介

Reference to Registrar under section 37 of the Registered Designs Rules

根據註冊外觀設計條例第 45 條，撤銷註冊

Revocation of Registration under section 45 of the Registered Designs Ordinance

根據註冊外觀設計規則第 46 條，向法院作出轉介

Reference to Court under section 46 of the Registered Designs Rules

根據註冊外觀設計規則第 63 條對不符合規定之處作出糾正

Rectification of Irregularities under section 63 of the Registered Designs Rules

根據註冊外觀設計條例第 66 條，糾正註冊紀錄冊

Rectification of Register under section 66 of the Registered Designs Ordinance

根據註冊外觀設計條例第 67 條 更正註冊紀錄冊內的錯誤

Correction of errors in Register under section 67 of the Registered Designs Ordinance

根據註冊外觀設計條例第 67 及 76 條，更正註冊紀錄冊內及已提交文件中的錯誤

Correction of Errors in Register and in Filed Documents under sections 67 and 76 of the Registered Designs Ordinance

根據註冊外觀設計條例第 76 條，更正已提交文件中的錯誤

Correction of errors in filed documents under section 76 of the Registered Designs Ordinance

註冊外觀設計公告註釋

Notes on advertisements of registration of designs

方括號表示下列資料：

Square brackets indicate the following data：

[11] 註冊編號 Registration number / 聯合王國註冊編號 United Kingdom registration number

[15] 註冊日期 Registration date / 當作註冊日期 Deemed registration date / 聯合王國註冊日期 United Kingdom registration date

[17] 註冊有效期屆滿日期 Expiry date of the period of registration

[22] 提交日期 Filing date / 當作提交日期 Deemed filing date / 聯合王國提交日期 United Kingdom filing date

[30] 聲稱享有的優先權（提交日期 / 巴黎公約國或世界貿易組織成員 / 申請編號） Priority claimed (filing date / Paris Convention country or WTO member / application number)

[51] 國際外觀設計分類號（洛迦諾分類號） International Classification of designs (Locarno Classification)

[54] 物品 Article

[55] 外觀設計的表述 Representation of the design

[62] 分開前的申請編號及提交日期 Application number before division and filing date

[66] 過往註冊的聯繫外觀設計註冊編號 / 日期 Registration No. / Date of Previous Registration for Association

[72] 設計人 Designer

[73] 擁有人姓名和地址 Name and address of the owner

[74] 代理人 Agent / 送達地址 Address for service



香港特別行政區政府知識產權署外觀設計註冊處

The Government of the Hong Kong Special Administrative Region

Designs Registry, Intellectual Property Department

根據註冊外觀設計條例第 25 條註冊的外觀設計

Designs registered under section 25 of the Registered Designs Ordinance

按註冊編號排列

Arranged by Registration Number

[11] 1914702.6

[15] 23-09-2019

[51] Cl. 21-01

[54] 遊戲圖

Game map

[73] 雷宇成

Lui Yu Shing

香港

東涌逸東邨

信逸樓 2004

[74] 雷宇成

香港

東涌逸東邨

信逸樓 2004

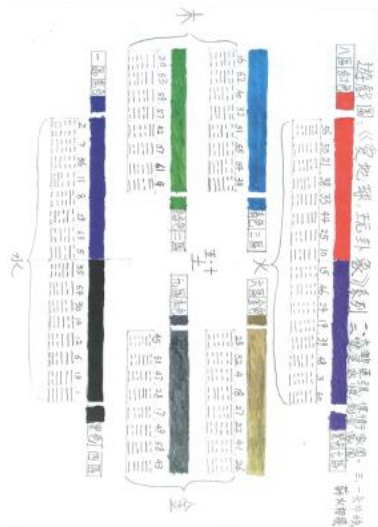

[11] 2015408.6

- [15] 13-01-2020
- [30] 12-07-2019 / CH, GB, EU / DM/203 491
- [51] Cl. 10-02
- [54] 錶
Watch
- [73] RICHEMONT INTERNATIONAL SA
Route des Biches 10,
CH - 1752 Villars-sur-Glâne,
Switzerland
- [74] UNION PATENT SERVICE CENTRE
Units E-F, 20th Floor, Neich Tower,
128 Gloucester Road,
Hong Kong

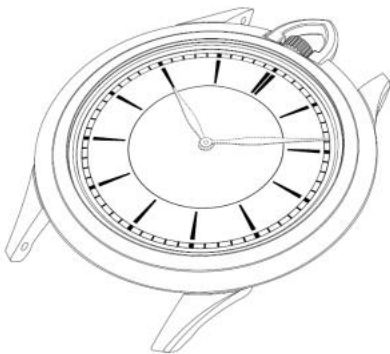

-
- [11] 2015484.5M001
- [15] 23-01-2020
- [30] 23-08-2019 / CH / 144852
- [51] Cl. 12-05
- [54] 電梯用操作和顯示面板
Operating and display panels for elevators
- [73] 因溫特奧股份公司
INVENTIO AG
Seestrasse 55, CH-6052,
Hergiswil NW,
Switzerland
- [74] MARKS & CLERK
Level 9, Cyberport 1,
100 Cyberport Road,
Pok Fu Lam, Hong Kong



[11] 2015484.5M002

[15] 23-01-2020

[30] 23-08-2019 / CH / 144852

[51] Cl. 12-05

[54] 電梯用操作和顯示面板

Operating and display panels for elevators

[73] 因溫特奧股份公司

INVENTIO AG

Seestrasse 55, CH-6052,

Hergiswil NW,

Switzerland

[74] MARKS & CLERK

Level 9, Cyberport 1,

100 Cyberport Road,

Pok Fu Lam, Hong Kong



- [11] 2015484.5M003
[15] 23-01-2020
[30] 23-08-2019 / CH / 144852
[51] Cl. 12-05
[54] 電梯用操作和顯示面板
Operating and display panels for elevators
[73] 因溫特奧股份公司
INVENTIO AG
Seestrasse 55, CH-6052,
Hergiswil NW,
Switzerland
[74] MARKS & CLERK
Level 9, Cyberport 1,
100 Cyberport Road,
Pok Fu Lam, Hong Kong



-
- [11] 2015484.5M004
[15] 23-01-2020
[30] 23-08-2019 / CH / 144852
[51] Cl. 12-05
[54] 電梯用操作和顯示面板
Operating and display panels for elevators
[73] 因溫特奧股份公司
INVENTIO AG
Seestrasse 55, CH-6052,
Hergiswil NW,
Switzerland
[74] MARKS & CLERK
Level 9, Cyberport 1,

100 Cyberport Road,
Pok Fu Lam, Hong Kong



[11] 2015607.9

[15] 14-02-2020

[51] Cl. 29-02

[54] 可換濾芯可重用醫學用布口罩

Reusable fabric surgical mask with user-exchangeable filter

[73] 裳樂匯坊有限公司

Sew On Studio Limited

香港荃灣

海盛路3號

TML 廣場 20 樓 B 室

[74] Lok Lai Ming (Sew On Studio Limited 裳樂匯坊)

香港荃灣

海盛路3號

TML 廣場 20 樓 B 室

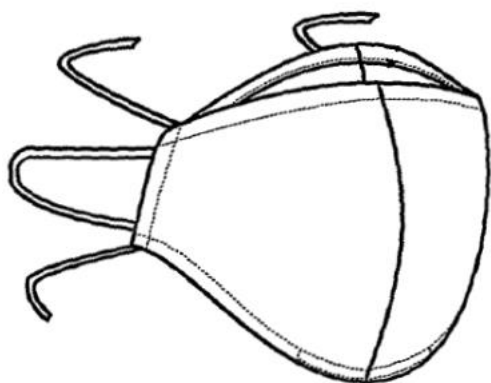

- [11] 2015646.1M001
[15] 21-02-2020
[30] 12-09-2019 / CN / 201930504771.8
[51] Cl. 14-04
[54] 用於手機的圖形用戶界面
Graphical user interface for mobile phone
[73] 騰訊科技（深圳）有限公司
TENCENT TECHNOLOGY (SHENZHEN) COMPANY
LIMITED
中國內地
518057 廣東省深圳市
南山區高新區科技中一路
騰訊大廈 35 層
[74] 集佳知識產權有限公司
香港九龍
旺角洗衣街 39-55 號
金雞廣場 12 層 1201 室



-
- [11] 2015646.1M002
[15] 21-02-2020
[30] 12-09-2019 / CN / 201930504771.8
[51] Cl. 14-04
[54] 用於手機的圖形用戶界面
Graphical user interface for mobile phone
[73] 騰訊科技（深圳）有限公司
TENCENT TECHNOLOGY (SHENZHEN) COMPANY
LIMITED
中國內地
518057 廣東省深圳市

南山區高新區科技中一路
騰訊大廈 35 層

- [74] 集佳知識產權有限公司
香港九龍
旺角洗衣街 39-55 號
金雞廣場 12 層 1201 室



[11] 2015646.1M003

[15] 21-02-2020

[30] 12-09-2019 / CN / 201930504771.8

[51] C1. 14-04

[54] 用於手機的圖形用戶界面
Graphical user interface for mobile phone

[73] 騰訊科技（深圳）有限公司
TENCENT TECHNOLOGY (SHENZHEN) COMPANY
LIMITED

中國內地

518057 廣東省深圳市

南山區高新區科技中一路

騰訊大廈 35 層

- [74] 集佳知識產權有限公司
香港九龍
旺角洗衣街 39-55 號
金雞廣場 12 層 1201 室



[11] 2015646.1M004

[15] 21-02-2020

[30] 12-09-2019 / CN / 201930504771.8

[51] Cl. 14-04

[54] 用於手機的圖形用戶界面

Graphical user interface for mobile phone

[73] 騰訊科技（深圳）有限公司

TENCENT TECHNOLOGY (SHENZHEN) COMPANY
LIMITED

中國內地

518057 廣東省深圳市

南山區高新區科技中一路

騰訊大廈 35 層

[74] 集佳知識產權有限公司

香港九龍

旺角洗衣街 39-55 號

金雞廣場 12 層 1201 室



[11] 2015646.1M005

[15] 21-02-2020

[30] 12-09-2019 / CN / 201930504771.8

[51] Cl. 14-04

[54] 用於手機的圖形用戶界面

Graphical user interface for mobile phone

[73] 騰訊科技（深圳）有限公司

TENCENT TECHNOLOGY (SHENZHEN) COMPANY
LIMITED

中國內地

518057 廣東省深圳市

南山區高新區科技中一路

騰訊大廈 35 層

[74] 集佳知識產權有限公司

香港九龍

旺角洗衣街 39-55 號

金雞廣場 12 層 1201 室



[11] 2015646.1M006

[15] 21-02-2020

[30] 12-09-2019 / CN / 201930504771.8

[51] Cl. 14-04

[54] 用於手機的圖形用戶界面

Graphical user interface for mobile phone

[73] 騰訊科技（深圳）有限公司

TENCENT TECHNOLOGY (SHENZHEN) COMPANY
LIMITED

中國內地

518057 廣東省深圳市

南山區高新區科技中一路

騰訊大廈 35 層

[74] 集佳知識產權有限公司

香港九龍

旺角洗衣街 39-55 號

金雞廣場 12 層 1201 室



[11] 2015646.1M007

[15] 21-02-2020

[30] 12-09-2019 / CN / 201930504771.8

[51] Cl. 14-04

[54] 用於手機的圖形用戶界面

Graphical user interface for mobile phone

[73] 騰訊科技（深圳）有限公司

TENCENT TECHNOLOGY (SHENZHEN) COMPANY
LIMITED

中國內地

518057 廣東省深圳市

南山區高新區科技中一路

騰訊大廈 35 層

[74] 集佳知識產權有限公司

香港九龍

旺角洗衣街 39-55 號

金雞廣場 12 層 1201 室



[11] 2015646.1M008

[15] 21-02-2020

[30] 12-09-2019 / CN / 201930504771.8

[51] Cl. 14-04

[54] 用於手機的圖形用戶界面
Graphical user interface for mobile phone

[73] 騰訊科技（深圳）有限公司
TENCENT TECHNOLOGY (SHENZHEN) COMPANY
LIMITED
中國內地
518057 廣東省深圳市
南山區高新區科技中一路
騰訊大廈 35 層

[74] 集佳知識產權有限公司
香港九龍
旺角洗衣街 39-55 號
金雞廣場 12 層 1201 室



[11] 2015646.1M009

[15] 21-02-2020

[30] 12-09-2019 / CN / 201930504771.8

[51] Cl. 14-04

[54] 用於手機的圖形用戶界面

Graphical user interface for mobile phone

[73] 騰訊科技（深圳）有限公司

TENCENT TECHNOLOGY (SHENZHEN) COMPANY
LIMITED

中國內地

518057 廣東省深圳市

南山區高新區科技中一路

騰訊大廈 35 層

[74] 集佳知識產權有限公司

香港九龍

旺角洗衣街 39-55 號

金雞廣場 12 層 1201 室



[11] 2015646.1M010

[15] 21-02-2020

[30] 12-09-2019 / CN / 201930504771.8

[51] Cl. 14-04

[54] 用於手機的圖形用戶界面
Graphical user interface for mobile phone

[73] 騰訊科技（深圳）有限公司
TENCENT TECHNOLOGY (SHENZHEN) COMPANY
LIMITED
中國內地
518057 廣東省深圳市
南山區高新區科技中一路
騰訊大廈 35 層

[74] 集佳知識產權有限公司
香港九龍
旺角洗衣街 39-55 號
金雞廣場 12 層 1201 室



[11] 2015718.4

[15] 09-03-2020

[51] Cl. 10-04

[54] 鋼拉尺

Steel measuring tape

[73] 益龍國際有限公司

Young Dragon International Limited

香港九龍觀塘

興業街 16-18 號

美興工業大廈 B 座 5 樓 06D 室

[74] 益龍國際有限公司

香港九龍觀塘

興業街 16-18 號

美興工業大廈 B 座 5 樓 06D 室



- [11] 2015764.0
- [15] 10-03-2020
- [30] 17-12-2019 / CN / 201930704847.1
- [51] Cl. 14-04
- [54] 顯示屏幕面板的會議詳情展示圖形用戶界面
Graphical user interface of conference detail display for display screen panel
- [73] 騰訊科技（深圳）有限公司
TENCENT TECHNOLOGY (SHENZHEN) COMPANY LIMITED
中國內地
廣東省深圳市南山區
高新區科技中一路
騰訊大廈 35 層
- [74] 集佳知識產權有限公司
香港九龍
旺角洗衣街 39-55 號
金雞廣場 12 層 1201 室



-
- [11] 2015765.3M001
 - [15] 10-03-2020
 - [30] 11-12-2019 / CN / 201930693625.4
 - [51] Cl. 14-04
 - [54] 顯示屏幕面板的會議設置動態圖形用戶界面
Dynamic graphical user interface of conference setting for display screen panel
 - [73] 騰訊科技（深圳）有限公司
TENCENT TECHNOLOGY (SHENZHEN) COMPANY LIMITED
中國內地
廣東省深圳市南山區

高新區科技中一路

騰訊大廈 35 層

[74] 集佳知識產權有限公司

香港九龍

旺角洗衣街 39-55 號

金雞廣場 12 層 1201 室

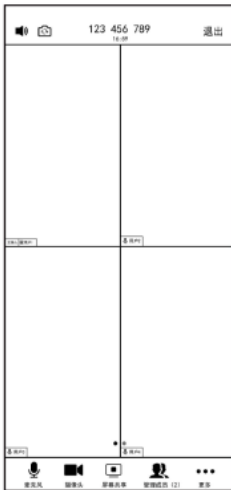

[11] 2015765.3M002

[15] 10-03-2020

[30] 11-12-2019 / CN / 201930693625.4

[51] Cl. 14-04

[54] 顯示屏幕面板的會議設置動態圖形用戶界面

Dynamic graphical user interface of conference setting for display screen panel

[73] 騰訊科技（深圳）有限公司

TENCENT TECHNOLOGY (SHENZHEN) COMPANY LIMITED

中國內地

廣東省深圳市南山區

高新區科技中一路

騰訊大廈 35 層

[74] 集佳知識產權有限公司

香港九龍

旺角洗衣街 39-55 號

金雞廣場 12 層 1201 室

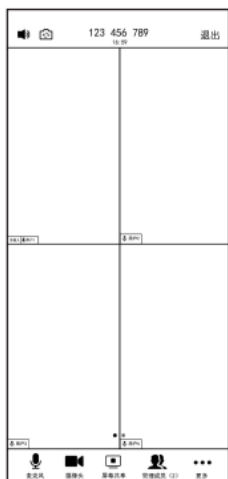

[11] 2015765.3M003

[15] 10-03-2020

[30] 11-12-2019 / CN / 201930693625.4

[51] Cl. 14-04

[54] 顯示屏幕面板的會議設置動態圖形用戶界面

Dynamic graphical user interface of conference setting for display screen panel

[73] 騰訊科技（深圳）有限公司

TENCENT TECHNOLOGY (SHENZHEN) COMPANY LIMITED

中國內地

廣東省深圳市南山區

高新區科技中一路

騰訊大廈 35 層

[74] 集佳知識產權有限公司

香港九龍

旺角洗衣街 39-55 號

金雞廣場 12 層 1201 室



[11] 2015765.3M004

[15] 10-03-2020

[30] 11-12-2019 / CN / 201930693625.4

[51] Cl. 14-04

[54] 顯示屏幕面板的會議設置動態圖形用戶界面

Dynamic graphical user interface of conference setting for display screen panel

[73] 騰訊科技（深圳）有限公司

TENCENT TECHNOLOGY (SHENZHEN) COMPANY LIMITED

中國內地

廣東省深圳市南山區

高新區科技中一路

騰訊大廈 35 層

[74] 集佳知識產權有限公司

香港九龍

旺角洗衣街 39-55 號

金雞廣場 12 層 1201 室



[11] 2015765.3M005

[15] 10-03-2020

[30] 11-12-2019 / CN / 201930693625.4

[51] Cl. 14-04

[54] 顯示屏幕面板的會議設置動態圖形用戶界面

Dynamic graphical user interface of conference setting for display screen panel

[73] 騰訊科技（深圳）有限公司

TENCENT TECHNOLOGY (SHENZHEN) COMPANY LIMITED

中國內地

廣東省深圳市南山區

高新區科技中一路

騰訊大廈 35 層

[74] 集佳知識產權有限公司

香港九龍

旺角洗衣街 39-55 號

金雞廣場 12 層 1201 室

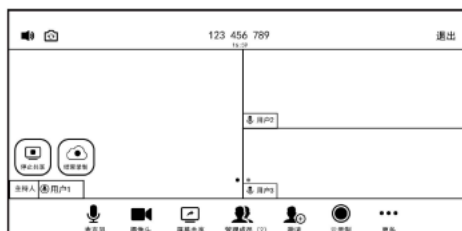

[11] 2015765.3M006

[15] 10-03-2020

[30] 11-12-2019 / CN / 201930693625.4

[51] Cl. 14-04

[54] 顯示屏幕面板的會議設置動態圖形用戶界面

Dynamic graphical user interface of conference setting for display screen panel

[73] 騰訊科技（深圳）有限公司

TENCENT TECHNOLOGY (SHENZHEN) COMPANY LIMITED

中國內地

廣東省深圳市南山區

高新區科技中一路

騰訊大廈 35 層

[74] 集佳知識產權有限公司

香港九龍

旺角洗衣街 39-55 號

金雞廣場 12 層 1201 室

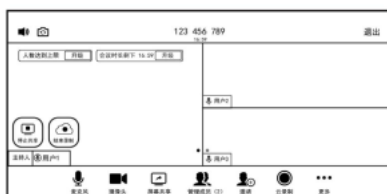

[11] 2015765.3M007

[15] 10-03-2020

[30] 11-12-2019 / CN / 201930693625.4

[51] Cl. 14-04

[54] 顯示屏幕面板的會議設置動態圖形用戶界面

Dynamic graphical user interface of conference setting for display screen panel

[73] 騰訊科技（深圳）有限公司

TENCENT TECHNOLOGY (SHENZHEN) COMPANY LIMITED

中國內地

廣東省深圳市南山區

高新區科技中一路

騰訊大廈 35 層

[74] 集佳知識產權有限公司

香港九龍

旺角洗衣街 39-55 號

金雞廣場 12 層 1201 室

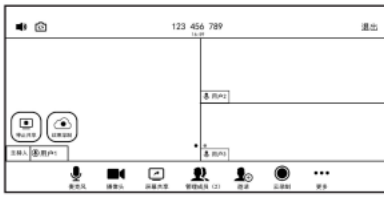

[11] 2015765.3M008

[15] 10-03-2020

[30] 11-12-2019 / CN / 201930693625.4

[51] Cl. 14-04

[54] 顯示屏幕面板的會議設置動態圖形用戶界面

Dynamic graphical user interface of conference setting for display screen panel

[73] 騰訊科技（深圳）有限公司

TENCENT TECHNOLOGY (SHENZHEN) COMPANY LIMITED

中國內地

廣東省深圳市南山區

高新區科技中一路

騰訊大廈 35 層

[74] 集佳知識產權有限公司

香港九龍

旺角洗衣街 39-55 號

金雞廣場 12 層 1201 室



[11] 2015765.3M009

[15] 10-03-2020

[30] 11-12-2019 / CN / 201930693625.4

[51] Cl. 14-04

[54] 顯示屏幕面板的會議設置動態圖形用戶界面

Dynamic graphical user interface of conference setting for display screen panel

[73] 騰訊科技（深圳）有限公司
TENCENT TECHNOLOGY (SHENZHEN) COMPANY LIMITED
中國內地
廣東省深圳市南山區
高新區科技中一路
騰訊大廈 35 層

[74] 集佳知識產權有限公司
香港九龍
旺角洗衣街 39-55 號
金雞廣場 12 層 1201 室



[11] 2015765.3M010

[15] 10-03-2020

[30] 11-12-2019 / CN / 201930693625.4

[51] C1. 14-04

[54] 顯示屏幕面板的會議設置動態圖形用戶界面
Dynamic graphical user interface of conference setting for
display screen panel

[73] 騰訊科技（深圳）有限公司
TENCENT TECHNOLOGY (SHENZHEN) COMPANY LIMITED
中國內地
廣東省深圳市南山區
高新區科技中一路
騰訊大廈 35 層

[74] 集佳知識產權有限公司
香港九龍
旺角洗衣街 39-55 號
金雞廣場 12 層 1201 室

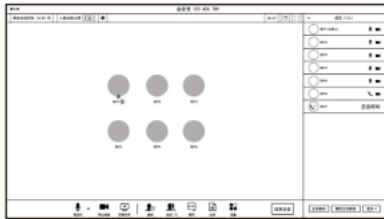

[11] 2015973.3

[15] 20-04-2020

[51] Cl. 3-01

[54] 手提背包

Handheld school bag

[73] 全港藝術發展有限公司

HONG KONG ART DEVELOPMENT COMPANY LIMITED

香港觀塘

開源道 72 號

溢財中心 3 樓 315 室

[74] 全港藝術發展有限公司

香港觀塘

開源道 72 號

溢財中心 3 樓 315 室



[11] 2016048.3

[15] 24-04-2020

[51] Cl. 29-02

[54] 口罩

Mask

[73] 自加有限公司

MIHI PLUS LIMITED

RM 612, 6/F., YUEN FAT INDUSTRIAL BUILDING,

25 WANG CHUI ROAD,

HONG KONG

[74] MIHI PLUS LIMITED

RM 612, 6/F., YUEN FAT INDUSTRIAL BUILDING,

25 WANG CHUI ROAD,

HONG KONG



[11] 2016052.1M001

[15] 24-04-2020

[51] Cl. 21-01

[54] 拼圖

Puzzle

[73] Po Kuen Emmy NG

Apartment 183 Metro Central Heights,

119 Newington Causeway,

London SE1 6BT,

United Kingdom

[74] IMARKET LICENSING LIMITED

Rm 1008, Prosperity Millennia Plaza,

663 King's Road,

Quarry Bay, Hong Kong

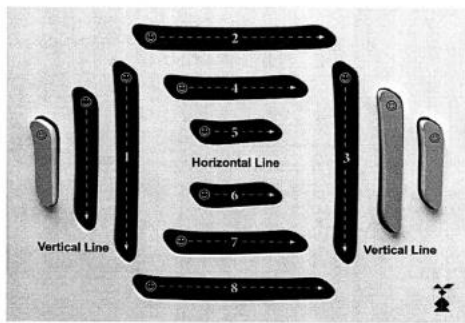

[11] 2016052.1M002

[15] 24-04-2020

[51] Cl. 21-01

[54] 拼圖

Puzzle

[73] Po Kuen Emmy NG

Apartment 183 Metro Central Heights,

119 Newington Causeway,

London SE1 6BT,

United Kingdom

[74] IMARKET LICENSING LIMITED

Rm 1008, Prosperity Millennia Plaza,

663 King's Road,

Quarry Bay, Hong Kong

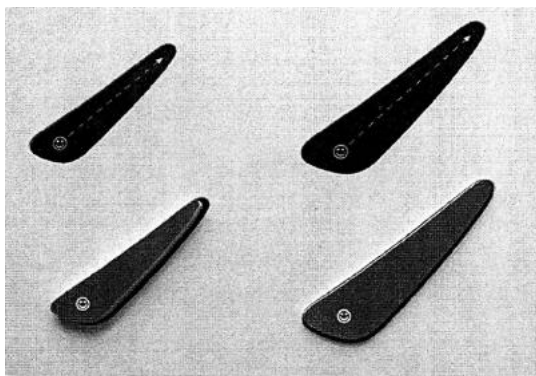

[11] 2016052.1M003

[15] 24-04-2020

[51] Cl. 21-01

[54] 拼圖

Puzzle

[73] Po Kuen Emmy NG
Apartment 183 Metro Central Heights,
119 Newington Causeway,
London SE1 6BT,
United Kingdom

[74] IMARKET LICENSING LIMITED
Rm 1008, Prosperity Millennia Plaza,
663 King's Road,
Quarry Bay, Hong Kong

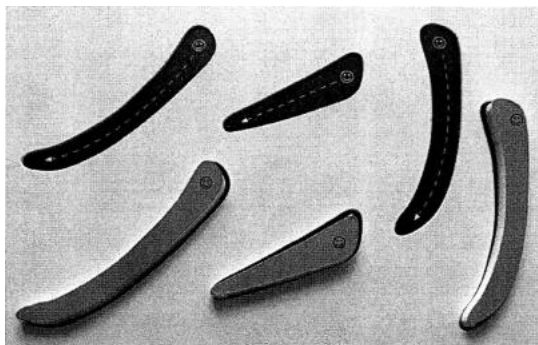

[11] 2016052.1M004

[15] 24-04-2020

[51] Cl. 21-01

[54] 拼圖
Puzzle

[73] Po Kuen Emmy NG
Apartment 183 Metro Central Heights,
119 Newington Causeway,
London SE1 6BT,
United Kingdom

[74] IMARKET LICENSING LIMITED
Rm 1008, Prosperity Millennia Plaza,
663 King's Road,
Quarry Bay, Hong Kong

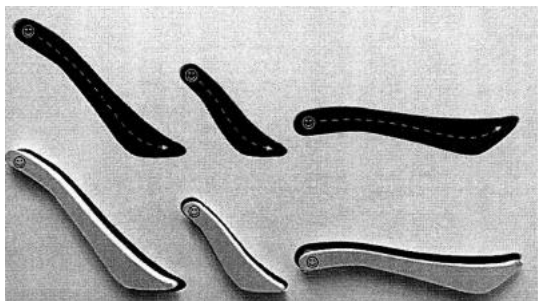

[11] 2016052.1M005

[15] 24-04-2020

[51] Cl. 21-01

[54] 拼圖

Puzzle

[73] Po Kuen Emmy NG

Apartment 183 Metro Central Heights,
119 Newington Causeway,
London SE1 6BT,
United Kingdom

[74] IMARKET LICENSING LIMITED

Rm 1008, Prosperity Millennia Plaza,
663 King's Road,
Quarry Bay, Hong Kong

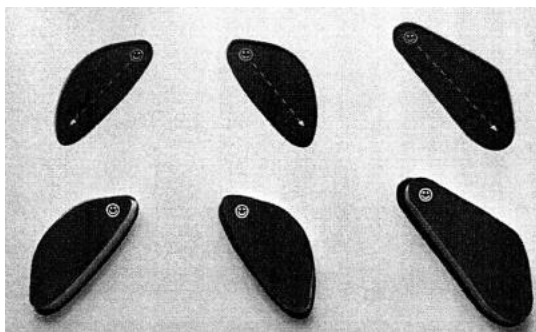

[11] 2016063.4M001

[15] 27-04-2020

[51] Cl. 3-01

[54] 行李系統

Luggage system

[73] BRIO DESIGN LTD.

7B, Woodbury Court,
137 Pok Fu Lam Road,
Hong Kong

[74] BRIO DESIGN LTD.

7B, Woodbury Court,
137 Pok Fu Lam Road,
Hong Kong



[11] 2016063.4M002

[15] 27-04-2020

[51] Cl. 3-01

[54] 行李系統

Luggage system

[73] BRIO DESIGN LTD.

7B, Woodbury Court,
137 Pok Fu Lam Road,
Hong Kong

[74] BRIO DESIGN LTD.

7B, Woodbury Court,
137 Pok Fu Lam Road,
Hong Kong



[11] 2016063.4M003

[15] 27-04-2020

[51] Cl. 3-01

[54] 行李系統

Luggage system

[73] BRIO DESIGN LTD.

7B, Woodbury Court,
137 Pok Fu Lam Road,
Hong Kong

[74] BRIO DESIGN LTD.

7B, Woodbury Court,
137 Pok Fu Lam Road,
Hong Kong



[11] 2016082.4M001

[15] 29-04-2020

[51] Cl. 23-01

[54] 多角度可屈曲灑水器

Multi-angled bendable sprinkler

[73] Bond Manufacturing Co., Inc.

2516 Verne Roberts Circle,
STE H3, Antioch, CA 94509,
United States

[74] ANGELA WANG & CO

14th Floor, South China Building,
1-3 Wyndham Street,
Central, Hong Kong



[11] 2016082.4M002

[15] 29-04-2020

[51] Cl. 23-01

[54] 多角度可屈曲灑水器

Multi-angled bendable sprinkler

[73] Bond Manufacturing Co., Inc.

2516 Verne Roberts Circle,

STE H3, Antioch, CA 94509,

United States

[74] ANGELA WANG & CO

14th Floor, South China Building,

1-3 Wyndham Street,

Central, Hong Kong



[11] 2016082.4M003

[15] 29-04-2020

[51] Cl. 23-01

[54] 多角度可屈曲灑水器

Multi-angled bendable sprinkler

[73] Bond Manufacturing Co., Inc.

2516 Verne Roberts Circle,

STE H3, Antioch, CA 94509,

United States

[74] ANGELA WANG & CO

14th Floor, South China Building,

1-3 Wyndham Street,

Central, Hong Kong



[11] 2016082.4M004

[15] 29-04-2020

[51] Cl. 23-01

[54] 多角度可屈曲灑水器

Multi-angled bendable sprinkler

[73] Bond Manufacturing Co., Inc.

2516 Verne Roberts Circle,

STE H3, Antioch, CA 94509,

United States

[74] ANGELA WANG & CO

14th Floor, South China Building,

1-3 Wyndham Street,

Central, Hong Kong



[11] 2016082.4M005

[15] 29-04-2020

[51] Cl. 23-01

[54] 多角度可屈曲灑水器

Multi-angled bendable sprinkler

[73] Bond Manufacturing Co., Inc.

2516 Verne Roberts Circle,

STE H3, Antioch, CA 94509,

United States

[74] ANGELA WANG & CO

14th Floor, South China Building,

1-3 Wyndham Street,

Central, Hong Kong



[11] 2016134.5M001

[15] 12-05-2020

[51] Cl. 26-05

[54] 發光二極管燈
LED light

[73] 甘恩洪以愛視麗照明科技公司之名營業

Kam, Yan Hung Paul trading as Eye's Light Lighting Company

香港新界荃灣

德士古道 168 號

德豐工業中心 1 座 25 樓 08 室

[74] 愛視麗照明科技公司

香港新界荃灣

德士古道 168 號

德豐工業中心 1 座 25 樓 08 室



[11] 2016134.5M002

[15] 12-05-2020

[51] Cl. 26-05

[54] 發光二極管燈
LED light

[73] 甘恩洪以愛視麗照明科技公司之名營業

Kam, Yan Hung Paul trading as Eye's Light Lighting Company

香港新界荃灣

德士古道 168 號

德豐工業中心 1 座 25 樓 08 室

[74] 愛視麗照明科技公司

香港新界荃灣

德士古道 168 號

德豐工業中心 1 座 25 樓 08 室



[11] 2016134.5M003

[15] 12-05-2020

[51] Cl. 26-05

[54] 發光二極管燈
LED light

[73] 甘恩洪以愛視麗照明科技公司之名營業

Kam, Yan Hung Paul trading as Eye's Light Lighting Company

香港新界荃灣

德士古道 168 號

德豐工業中心 1 座 25 樓 08 室

[74] 愛視麗照明科技公司

香港新界荃灣

德士古道 168 號

德豐工業中心 1 座 25 樓 08 室



[11] 2016148.5

[15] 14-05-2020

[51] Cl. 19-08

[54] 挪威三文魚柳標籤卡紙
Label card of norwegian salmon fillet

[73] 晨達發展有限公司
Silver Dynamic Development Ltd
香港上環
干諾道西 21-24 號
海景商業大廈 20 樓 2001 室

[74] 晨達發展有限公司
香港上環
干諾道西 21-24 號
海景商業大廈 20 樓 2001 室



[11] 2016163.6

[15] 19-05-2020

[30] 21-11-2019 / CN / 201930644529.0

[51] Cl. 14-02

[54] 支付設備
Payment device

[73] Alipay (Hangzhou) Information Technology Co., Ltd.
No. 556 Xixi Road, 8th Floor,
Section B, Suite 801-11, West Lake District, Hangzhou,
Zhejiang, China 310000, China

[74] SPRUSON & FERGUSON (HONG KONG) LIMITED
5001 Hopewell Centre,
183 Queen's Road East,
Wan Chai, Hong Kong

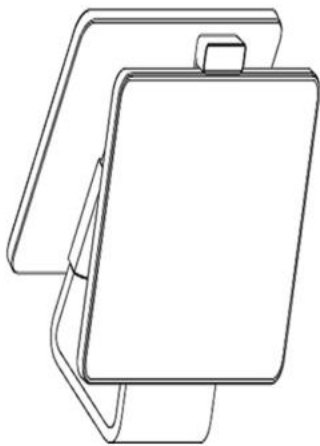

[11] 2016171.3

[15] 19-05-2020

[30] 20-11-2019 / CN / 201930641336.X

[51] Cl. 16-06

[54] 太陽眼鏡

Sun glasses

[73] 上海歆芸貿易有限公司

SHANGHAI SHARING TRADING CO., LTD.

中國內地

上海市閔行區

虹莘路 3999 號 717 室

[74] 德龍知識產權集團（香港）有限公司

香港灣仔

軒尼詩道 338 號

北海中心 10 樓 E 室



[11] 2016198.0M001

[15] 21-05-2020

[30] 27-11-2019 / CN / 201930657987.8

[51] Cl. 10-07

[54] 錶帶

Watch strap

[73] 北京小米移動軟件有限公司

BEIJING XIAOMI MOBILE SOFTWARE CO., LTD.

中國內地

北京市海澱區西二旗中路 33 號院

6 號樓 8 層 018 號

[74] 香港派特恩知識產權代理有限公司

香港上環

永樂街 121-125 號

永達商業大廈 10 樓 C 室

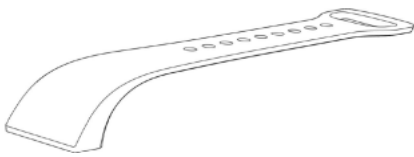

[11] 2016198.0M002

[15] 21-05-2020

[30] 27-11-2019 / CN / 201930657987.8

[51] Cl. 10-07

[54] 錶帶

Watch strap

[73] 北京小米移動軟件有限公司

BEIJING XIAOMI MOBILE SOFTWARE CO., LTD.

中國內地

北京市海澱區西二旗中路 33 號院

6 號樓 8 層 018 號

[74] 香港派特恩知識產權代理有限公司

香港上環

永樂街 121-125 號

永達商業大廈 10 樓 C 室

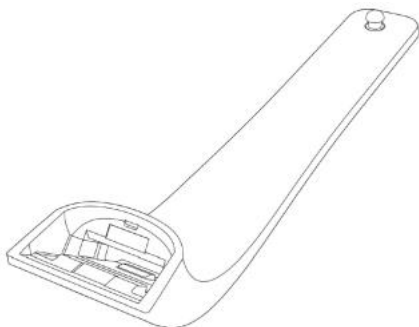

- [11] 2016223.4M001
[15] 26-05-2020
[30] 23-08-2019 / US / 29/703,109
[51] Cl. 11-01
[54] 經配置的珠寶鑽石
Jewelry diamond arrangement
[73] 榮義珠寶玉石有限公司
Wing Yee Gems & Jewellery
香港九龍
紅磡崇平街 2 號
富德中心 7 樓 701-702 室
[74] 智雅知識產權代理公司
香港荃灣
青山道 264-298 號
南豐中心 1905 室



-
- [11] 2016223.4M002
[15] 26-05-2020
[30] 23-08-2019 / US / 29/703,109
[51] Cl. 11-01
[54] 經配置的珠寶鑽石
Jewelry diamond arrangement
[73] 榮義珠寶玉石有限公司
Wing Yee Gems & Jewellery
香港九龍
紅磡崇平街 2 號
富德中心 7 樓 701-702 室
[74] 智雅知識產權代理公司
香港荃灣
青山道 264-298 號
南豐中心 1905 室

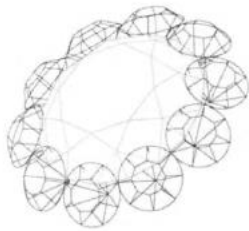

[11] 2016223.4M003

[15] 18-11-2019

[30] 23-08-2019 / US / 29/703,109

[51] Cl. 11-01

[54] 經配置的珠寶鑽石

Jewelry diamond arrangement

[73] 榮義珠寶玉石有限公司

Wing Yee Gems & Jewellery

香港九龍

紅磡崇平街 2 號

富德中心 7 樓 701-702 室

[74] 智雅知識產權代理公司

香港荃灣

青山道 264-298 號

南豐中心 1905 室

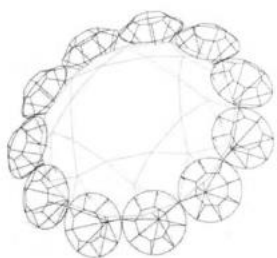

[11] 2016223.4M004

[15] 18-11-2019

[30] 23-08-2019 / US / 29/703,109

[51] Cl. 11-01

[54] 經配置的珠寶鑽石
Jewelry diamond arrangement

[73] 榮義珠寶玉石有限公司
Wing Yee Gems & Jewellery
香港九龍
紅磡崇平街 2 號
富德中心 7 樓 701-702 室

[74] 智雅知識產權代理公司
香港荃灣
青山道 264-298 號
南豐中心 1905 室

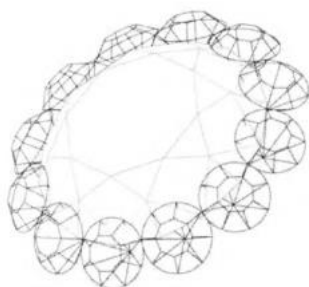

[11] 2016230.9M001

[15] 26-05-2020

[30] 08-04-2020 / CN / 202030133521.0

[51] Cl. 13-02

[54] 無線充電移動電源
Wireless charging mobile power supply

[73] 廣東高普達集團股份有限公司
GUANGDONG GOPOD GROUP HOLDING CO., LTD
中國內地
廣東省深圳市龍華新區大浪街道同勝社區華榮路
聯建科技工業園廠房 8 棟 4, 5, 6 樓

[74] 中一聯合國際知識產權有限公司
香港九龍
尖沙咀漆咸道南 45-51 號
其士大廈 803 室



[11] 2016230.9M002

[15] 26-05-2020

[30] 08-04-2020 / CN / 202030133521.0

[51] Cl. 13-02

[54] 無線充電移動電源

Wireless charging mobile power supply

[73] 廣東高普達集團股份有限公司

GUANGDONG GOPOD GROUP HOLDING CO., LTD

中國內地

廣東省深圳市龍華新區大浪街道同勝社區華榮路

聯建科技工業園廠房 8 棟 4,5,6 樓

[74] 中一聯合國際知識產權有限公司

香港九龍

尖沙咀漆咸道南 45-51 號

其士大廈 803 室

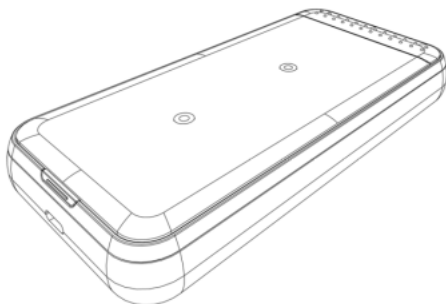

[11] 2016243.6

[15] 28-05-2020

[51] Cl. 24-01

[54] 醫療口罩

Medical mask

[73] 真。護。有限公司
 Real Care Limited
 香港九龍尖沙咀麼地道 67 號半島中心 7 樓 702 室

[74] Jan Lai
 香港九龍尖沙咀麼地道 67 號半島中心 7 樓 702 室

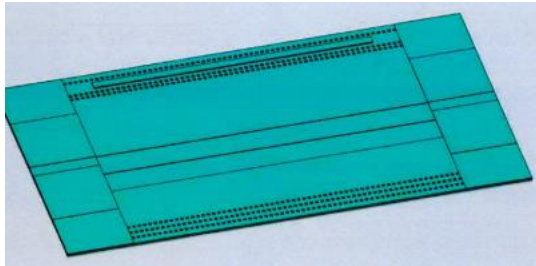

[11] 2016274.1M001

[15] 04-06-2020

[51] Cl. 9-05

[54] 挪威三文魚柳包裝袋
 Bag of norwegian salmon fillet

[73] 晨達發展有限公司
 Silver Dynamic Development Ltd
 香港上環
 干諾道西 21-24 號
 海景商業大廈 20 樓 2001 室

[74] 晨達發展有限公司
 香港上環
 干諾道西 21-24 號
 海景商業大廈 20 樓 2001 室

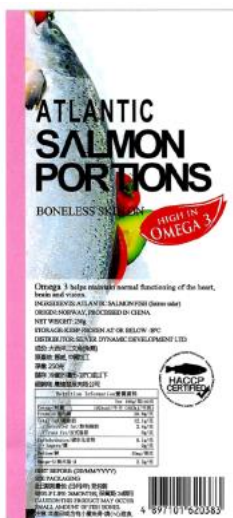

[11] 2016274.1M002

[15] 04-06-2020

[51] Cl. 9-05

[54] 三文魚柳包裝袋
Bag of salmon fillet

[73] 晨達發展有限公司
Silver Dynamic Development Ltd
香港上環
干諾道西 21-24 號
海景商業大廈 20 樓 2001 室

[74] 晨達發展有限公司
香港上環
干諾道西 21-24 號
海景商業大廈 20 樓 2001 室

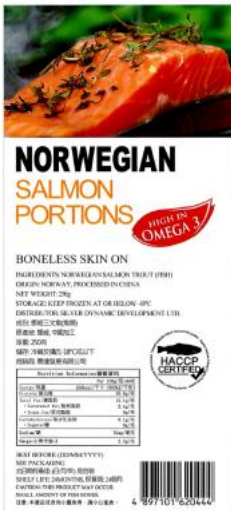

[11] 2016275.4M001

[15] 04-06-2020

[51] Cl. 19-08

[54] 三文魚扒卡紙
Product card of salmon steak

[73] 晨達發展有限公司
Silver Dynamic Development Ltd
香港上環
干諾道西 21-24 號
海景商業大廈 20 樓 2001 室

[74] 晨達發展有限公司
香港上環

干諾道西 21-24 號
海景商業大廈 20 樓 2001 室



- [11] 2016275.4M002
- [15] 04-06-2020
- [51] Cl. 19-08
- [54] 三文魚扒卡紙
Product card of salmon steak
- [73] 晨達發展有限公司
Silver Dynamic Development Ltd
香港上環
干諾道西 21-24 號
海景商業大廈 20 樓 2001 室
- [74] 晨達發展有限公司
香港上環
干諾道西 21-24 號
海景商業大廈 20 樓 2001 室



[11] 2016287.9

[15] 05-06-2020

[51] Cl. 23-04

[54] 香薰機

Aroma diffuser

[73] 璞真生活有限公司

PUZHEN LIFE CO., LTD

Unit 1112-1116, 11/F, Delta House,

3 On Yiu Street,

Shatin, Hong Kong

[74] FEDERATION OF HONG KONG INDUSTRIES

31/F, Billion Plaza,

8 Cheung Yue Street,

Cheung Sha Wan, Kowloon, Hong Kong



[11] 2016290.5M001

[15] 08-06-2020

[30] 16-12-2019 / US / 29/717,147

[51] Cl. 22-01

[54] 手槍

Pistol

[73] SMITH & WESSON INC.

2100 Roosevelt Avenue,
Springfield, MA 01104,
United States

[74] CHINA PATENT AGENT (HONG KONG) LIMITED

22/F, Great Eagle Centre,
23 Harbour Road,
Wanchai, Hong Kong



[11] 2016290.5M002

[15] 08-06-2020

[30] 16-12-2019 / US / 29/717,147

[51] Cl. 22-01

[54] 手槍

Pistol

[73] SMITH & WESSON INC.

2100 Roosevelt Avenue,
Springfield, MA 01104,
United States

[74] CHINA PATENT AGENT (HONG KONG) LIMITED

22/F, Great Eagle Centre,
23 Harbour Road,
Wanchai, Hong Kong



[11] 2016290.5M003

[15] 08-06-2020

[30] 16-12-2019 / US / 29/717,147

[51] Cl. 22-01

[54] 手槍

Pistol

[73] SMITH & WESSON INC.

2100 Roosevelt Avenue,
Springfield, MA 01104,
United States

[74] CHINA PATENT AGENT (HONG KONG) LIMITED

22/F, Great Eagle Centre,
23 Harbour Road,
Wanchai, Hong Kong



[11] 2016291.7M001

[15] 08-06-2020

[30] 31-03-2020 / CN / 202030118986.9

[51] Cl. 9-01

[54] 瓶子

Bottle

[73] 曼秀雷敦(中國)藥業有限公司

Mentholatum (China) Pharmaceutical Company Limited
The Second Industrial District, Sanxiang Town,
Zhongshan City, Guangdong Province,
China

[74] MAYER BROWN

16th-19th Floors, Prince's Building,
10 Chater Road, Central,
Hong Kong



[11] 2016291.7M002

[15] 08-06-2020

[30] 31-03-2020 / CN / 202030119943.2

[51] Cl. 9-01

[54] 圓身瓶子

Cylindrical bottle

[73] 曼秀雷敦(中國)藥業有限公司

Mentholatum (China) Pharmaceutical Company Limited
The Second Industrial District, Sanxiang Town,
Zhongshan City, Guangdong Province,
China

[74] MAYER BROWN

16th-19th Floors, Prince's Building,

10 Chater Road, Central,
Hong Kong



[11] 2016292.9M001

[15] 08-06-2020

[51] Cl. 19-08

[54] 標貼
Label

[73] Mentholatum (Asia Pacific) Ltd.
Room 2111-21, Tower 2, Grand Central Plaza,
138 Shatin Rural Committee Road,
Shatin, New Territories, Hong Kong

[74] MAYER BROWN
16th-19th Floors, Prince's Building,
10 Chater Road, Central,
Hong Kong



- [11] 2016292.9M002
- [15] 08-06-2020
- [51] Cl. 19-08
- [54] 標貼
Label
- [73] Mentholatum (Asia Pacific) Ltd.
Room 2111-21, Tower 2, Grand Central Plaza,
138 Shatin Rural Committee Road,
Shatin, New Territories, Hong Kong
- [74] MAYER BROWN
16th-19th Floors, Prince's Building,
10 Chater Road, Central,
Hong Kong



- [11] 2016293.1
- [15] 08-06-2020
- [51] Cl. 9-03
- [54] 包裝盒
Packaging box
- [73] Mentholatum (Asia Pacific) Ltd.
Room 2111-21, Tower 2, Grand Central Plaza,
138 Shatin Rural Committee Road,
Shatin, New Territories. Hong Kong
- [74] MAYER BROWN
16th-19th Floors, Prince's Building,
10 Chater Road, Central,
Hong Kong



[11] 2016295.6

[15] 08-06-2020

[30] 02-03-2020 / CN / 202030066169.3

[51] C1. 16-01

[54] 攝像頭
Camera

[73] 北京小米移動軟件有限公司
Beijing Xiaomi Mobile Software Co., Ltd.
中國內地
北京市海澱區西二旗中路 33 號院
6 號樓 8 層 018 號

[74] 隆天專利商標代理有限公司
香港長沙灣
青山道 485 號
九龍廣場 10 樓 11 室

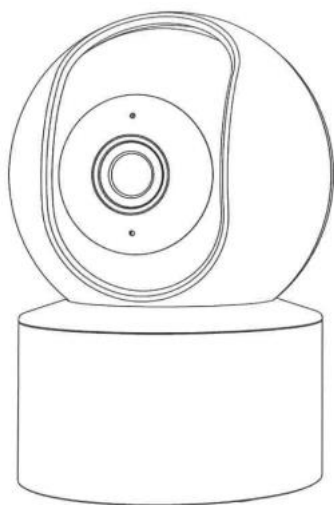

- [11] 2016299.4
[15] 08-06-2020
[30] 20-12-2019 / EU / 007439385-0002
[51] Cl. 2-04
[54] 鞋
Shoe
[73] BALENCIAGA
40 rue de Sèvres,
75007 Paris,
France
[74] DEACONS
5th Floor, Alexandra House,
Central,
Hong Kong



-
- [11] 2016300.8
[15] 08-06-2020
[30] 25-12-2019 / JP / 028755 of 2019
[51] Cl. 7-99
[54] 個人保暖物
Personal warming apparatus
[73] Kobayashi Pharmaceutical Co., Ltd.
4-10, Doshomachi 4-chome,
Chuo-ku, Osaka-shi, Osaka,
Japan
[74] DEACONS
5th Floor, Alexandra House,
Central,
Hong Kong

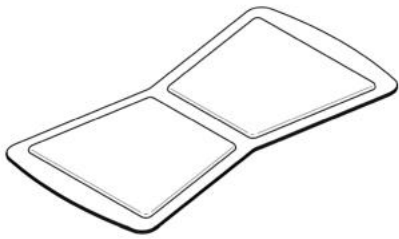

[11] 2016301.0

[15] 09-06-2020

[51] Cl. 7-01

[54] 杯
Mug

[73] ZOJIRUSHI CORPORATION
1-20-5, Tenma, Kita-ku,
Osaka, 530-8511,
Japan

[74] HASTINGS & CO
5/F Gloucester Tower, The Landmark,
11 Pedder Street,
Central, Hong Kong

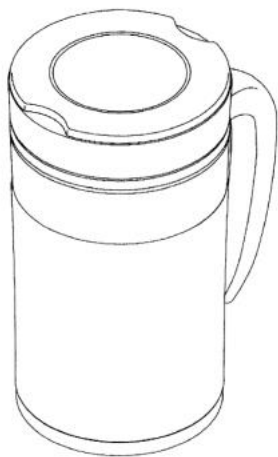

[11] 2016303.4

[15] 09-06-2020

[30] 12-12-2019 / EU / 007379342-0001

[51] Cl. 28-02

[54] 唇膏盒
Lipstick case

[73] LVMH FRAGRANCE BRANDS
77 Rue Anatole France,
92300 Levallois Perret,
France

[74] WENPING PATENT & TRADE MARK AGENT LIMITED
1701 Tung Wai Commercial Building,
111 Gloucester Road,
Hong Kong

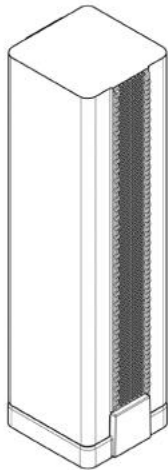

[11] 2016304.6M001

[15] 09-06-2020

[30] 11-12-2019 / EU / 007382155-0003

[51] Cl. 3-01

[54] 手袋
Handbag

[73] BOTTEGA VENETA S.R.L.
Località Conti Maltraverso 1,
36054 Montebello Vicentino (VI),
Italy

[74] ELLALAN
26th and 28th Floors, The Hennessy,
256 Hennessy Road,
Wanchai, Hong Kong



[11] 2016304.6M002

[15] 09-06-2020

[30] 11-12-2019 / EU / 007382155-0004

[51] Cl. 3-01

[54] 手袋

Handbag

[73] BOTTEGA VENETA S.R.L.

Località Conti Maltraverso 1,
36054 Montebello Vicentino (VI),
Italy

[74] ELLALAN

26th and 28th Floors, The Hennessy,
256 Hennessy Road,
Wanchai, Hong Kong



[11] 2016304.6M003

[15] 09-06-2020

[30] 11-12-2019 / EU / 007382155-0006

[51] Cl. 3-01

[54] 手袋

Handbag

[73] BOTTEGA VENETA S.R.L.

Località Conti Maltraverso 1,
36054 Montebello Vicentino (VI),
Italy

[74] ELLALAN

26th and 28th Floors, The Hennessy,
256 Hennessy Road,
Wanchai, Hong Kong



[11] 2016304.6M004

[15] 09-06-2020

[30] 11-12-2019 / EU / 007382155-0007

[51] Cl. 3-01

[54] 手袋

Handbag

[73] BOTTEGA VENETA S.R.L.

Località Conti Maltraverso 1,
36054 Montebello Vicentino (VI),
Italy

[74] ELLALAN

26th and 28th Floors, The Hennessy,
256 Hennessy Road,
Wanchai, Hong Kong



[11] 2016305.9

[15] 09-06-2020

[30] 18-12-2019 / JP / 028112 of 2019

[51] Cl. 12-12

[54] 嬰兒車架

Frame for baby carriage

[73] 康貝株式會社

Combi Corporation

6-7, Motoasakusa 2-chome,

Taito-ku, Tokyo 111-0041,

Japan

[74] WILKINSON & GRIST

6th Floor, Prince's Building,

Chater Road,

Hong Kong



- [11] 2016306.1
[15] 09-06-2020
[30] 18-12-2019 / JP / 028114 of 2019
[51] Cl. 12-12
[54] 嬰兒車
Baby carriage
[73] 康貝株式會社
Combi Corporation
6-7, Motoasakusa 2-chome,
Taito-ku, Tokyo 111-0041,
Japan
[74] WILKINSON & GRIST
6th Floor, Prince's Building,
Chater Road,
Hong Kong



-
- [11] 2016307.3M001
[15] 09-06-2020
[51] Cl. 6-04
[54] 櫃
Cabinet
[73] New World Development Company Limited
30th Floor, New World Tower,
18 Queen's Road Central,
Hong Kong
[74] MARKS & CLERK
Level 9, Cyberport 1,
100 Cyberport Road,
Pok Fu Lam, Hong Kong

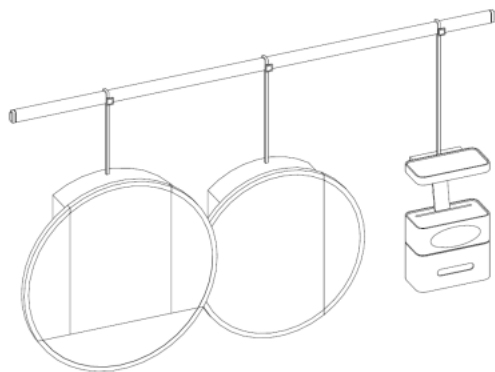

[11] 2016307.3M002

[15] 09-06-2020

[51] Cl. 6-04

[54] 櫃

Cabinet

[73] New World Development Company Limited
30th Floor, New World Tower,
18 Queen's Road Central,
Hong Kong

[74] MARKS & CLERK

Level 9, Cyberport 1,
100 Cyberport Road,
Pok Fu Lam, Hong Kong

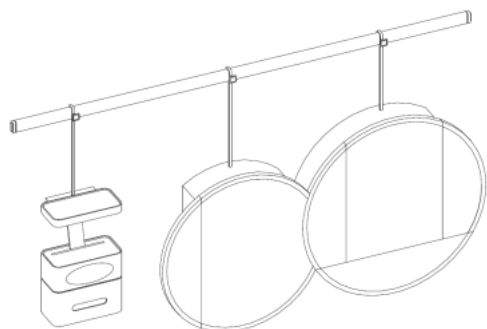

[11] 2016307.3M003

[15] 09-06-2020

[51] Cl. 6-04

[54] 櫃

Cabinet

[73] New World Development Company Limited
30th Floor, New World Tower,

18 Queen's Road Central,
Hong Kong

- [74] MARKS & CLERK
Level 9, Cyberport 1,
100 Cyberport Road,
Pok Fu Lam, Hong Kong

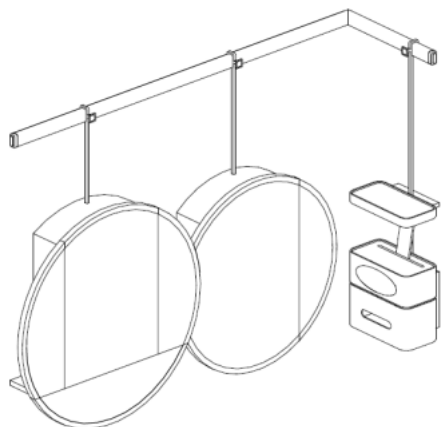

-
- [11] 2016308.5
[15] 10-06-2020
[30] 23-12-2019 / EU / 007448832-0001
[51] Cl. 28-02
[54] 肥皂
Soap
[73] 雷克特本克斯爾健康有限公司
Reckitt Benckiser Health Limited
103-105 Bath Road, Slough,
Berkshire, SL1 3UH,
United Kingdom
[74] SANYOU INTELLECTUAL PROPERTY LIMITED
Room 601, 6/F., Yue Xiu Building,
160-174 Lockhart Road,
Wanchai, Hong Kong

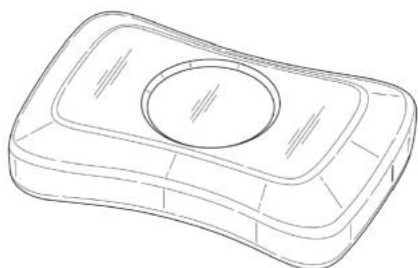

[11] 2016309.7

[15] 10-06-2020

[51] Cl. 2-02

[54] 防暴背心

Riot vest

[73] 東安(遠東)有限公司

Eastern Forum (Far East) Company Limited

香港九龍

長沙灣青山道 688 至 690 號

嘉名工廠大廈 2 樓 E 室

[74] 東安(遠東)有限公司

香港九龍

長沙灣青山道 688 至 690 號

嘉名工廠大廈 2 樓 E 室

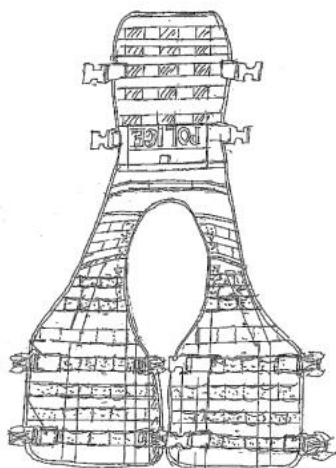

[11] 2016310.9

[15] 10-06-2020

[51] Cl. 23-04

[54] 香薰機

Aroma diffuser

[73] 璞真生活有限公司

PUZHEN LIFE CO., LTD

Unit 1112-1116, 11/F, Delta House,

3 On Yiu Street,

Shatin, Hong Kong

[74] FEDERATION OF HONG KONG INDUSTRIES

31/F, Billion Plaza,

8 Cheung Yue Street,

Cheung Sha Wan, Kowloon, Hong Kong

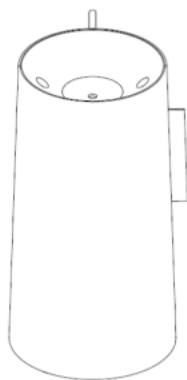

[11] 2016311.1

[15] 10-06-2020

[51] Cl. 23-04

[54] 香薰機

Aroma diffuser

[73] 璞真生活有限公司

PUZHEN LIFE CO., LTD

Unit 1112-1116, 11/F, Delta House,

3 On Yiu Street,

Shatin, Hong Kong

[74] FEDERATION OF HONG KONG INDUSTRIES

31/F, Billion Plaza,

8 Cheung Yue Street,

Cheung Sha Wan, Kowloon, Hong Kong

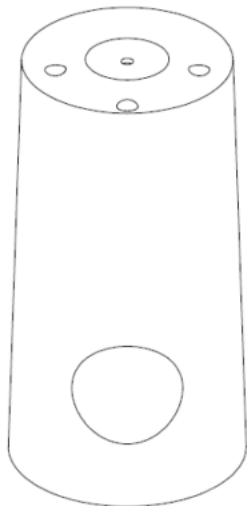

[11] 2016313.5

[15] 10-06-2020

[51] Cl. 23-04

[54] 光電空氣消毒器

Photoelectronic air sterillzer

[73] 中興科技集團有限公司

John Technology Holdings Limited

Flat B, 7/F, Everwin Centre,

72 Hung To Road,

Kwun Tong, Kowloon, Hong Kong

袁仕傑

YUEN SE KIT

Flat B, 7/F, Everwin Centre,

72 Hung To Road,

Kwun Tong, Kowloon, HONG KONG

[74] JOHN MANUFACTURING LIMITED

Flat B, 7/F, Everwin Centre,

72 Hung To Road,

Kwun Tong, Kowloon, Hong Kong

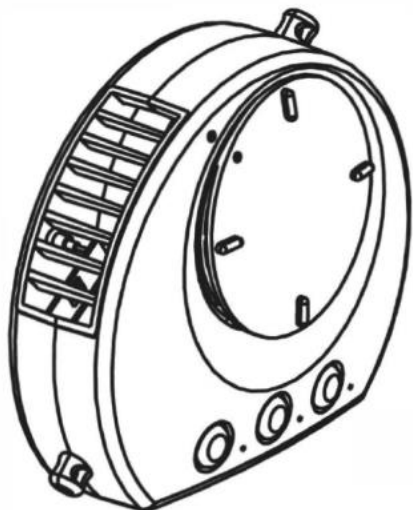

[11] 2016315.0

[15] 10-06-2020

[51] Cl. 9-09

[54] 一種翻斗

A tipping

[73] 王仔物流運輸有限公司

WONG TSAI LOGISTICS & TRANSPORTATION LIMITED

香港觀塘

鴻圖道 88 號

志聯中心 8 樓 B 室

[74] 環球邦信知識產權有限公司

香港銅鑼灣

告士打道 255-257 號

信和廣場 22 樓 05 室



[11] 2016316.2M001

[15] 11-06-2020

[51] Cl. 11-01

[54] 飾物設計

Ornament design

[73] 六福集團有限公司

Luk Fook Holdings Company Limited
Floor 15, 20, 25 & 27, Metropole Square,
No.2 On Yiu Street,
Shatin, New Territories, Hong Kong

[74] Luk Fook Holdings Company Limited (Legal Affairs Department)

Floor 25, Metropole Square,
No.2 On Yiu Street,
Shatin, New Territories, Hong Kong



[11] 2016316.2M002

[15] 11-06-2020

[51] Cl. 11-01

[54] 飾物設計

Ornament design

[73] 六福集團有限公司

Luk Fook Holdings Company Limited
Floor 15, 20, 25 & 27, Metropole Square,
No.2 On Yiu Street,
Shatin, New Territories, Hong Kong

[74] Luk Fook Holdings Company Limited (Legal Affairs Department)

Floor 25, Metropole Square,
No.2 On Yiu Street,
Shatin, New Territories, Hong Kong



[11] 2016316.2M003

[15] 11-06-2020

[51] Cl. 11-01

[54] 飾物設計

Ornament design

[73] 六福集團有限公司

Luk Fook Holdings Company Limited
Floor 15, 20, 25 & 27, Metropole Square,
No.2 On Yiu Street,
Shatin, New Territories, Hong Kong

[74] Luk Fook Holdings Company Limited (Legal Affairs Department)

Floor 25, Metropole Square,
No.2 On Yiu Street,
Shatin, New Territories, Hong Kong



[11] 2016316.2M004

[15] 11-06-2020

[51] Cl. 11-01

[54] 飾物設計

Ornament design

[73] 六福集團有限公司

Luk Fook Holdings Company Limited
Floor 15, 20, 25 & 27, Metropole Square,

No.2 On Yiu Street,
Shatin, New Territories, Hong Kong

- [74] Luk Fook Holdings Company Limited (Legal Affairs Department)
Floor 25, Metropole Square,
No.2 On Yiu Street,
Shatin, New Territories, Hong Kong



[11] 2016316.2M005

[15] 11-06-2020

[51] Cl. 11-01

[54] 飾物設計

Ornament design

[73] 六福集團有限公司

Luk Fook Holdings Company Limited
Floor 15, 20, 25 & 27, Metropole Square,
No.2 On Yiu Street,
Shatin, New Territories, Hong Kong

- [74] Luk Fook Holdings Company Limited (Legal Affairs Department)
Floor 25, Metropole Square,
No.2 On Yiu Street,
Shatin, New Territories, Hong Kong



[11] 2016316.2M006

[15] 11-06-2020

[51] Cl. 11-01

[54] 飾物設計

Ornament design

[73] 六福集團有限公司

Luk Fook Holdings Company Limited

Floor 15, 20, 25 & 27, Metropole Square,

No.2 On Yiu Street,

Shatin, New Territories, Hong Kong

[74] Luk Fook Holdings Company Limited (Legal Affairs Department)

Floor 25, Metropole Square,

No.2 On Yiu Street,

Shatin, New Territories, Hong Kong



[11] 2016316.2M007

[15] 11-06-2020

[51] Cl. 11-01

[54] 飾物設計

Ornament design

[73] 六福集團有限公司

Luk Fook Holdings Company Limited

Floor 15, 20, 25 & 27, Metropole Square,

No.2 On Yiu Street,

Shatin, New Territories, Hong Kong

[74] Luk Fook Holdings Company Limited (Legal Affairs Department)

Floor 25, Metropole Square,

No.2 On Yiu Street,

Shatin, New Territories, Hong Kong



[11] 2016316.2M008

[15] 11-06-2020

[51] Cl. 11-01

[54] 飾物設計

Ornament design

[73] 六福集團有限公司

Luk Fook Holdings Company Limited

Floor 15, 20, 25 & 27, Metropole Square,

No.2 On Yiu Street,

Shatin, New Territories, Hong Kong

[74] Luk Fook Holdings Company Limited (Legal Affairs Department)

Floor 25, Metropole Square,

No.2 On Yiu Street,

Shatin, New Territories, Hong Kong



[11] 2016317.4

[15] 11-06-2020

[51] Cl. 10-07

[54] 錶殼

Watch case

[73] LVMH SWISS MANUFACTURES SA

Rue Louis-Joseph Chevrolet 6A,

2300 La Chaux-de-Fonds,
Switzerland

[74] WENPING PATENT & TRADE MARK AGENT LIMITED
1701 Tung Wai Commercial Building,
111 Gloucester Road,
Hong Kong



[11] 2016319.8

[15] 11-06-2020

[51] Cl. 23-04

[54] 香薰機

Aroma diffuser

[73] 璞真生活有限公司

PUZHEN LIFE CO., LTD

Unit 1112-1116, 11/F, Delta House,

3 On Yiu Street,

Shatin, Hong Kong

[74] FEDERATION OF HONG KONG INDUSTRIES

31/F, Billion Plaza,

8 Cheung Yue Street,

Cheung Sha Wan, Kowloon, Hong Kong

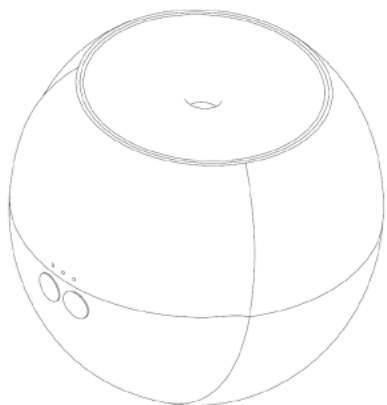

[11] 2016320.0

[15] 11-06-2020

[51] Cl. 6-06

[54] 座檯式屏擋

Shield stand for desktop

[73] BRIGHT MIND LIMITED

Room 906, 9/F., Kowloon Bay Industrial Center,
15 Wang Hoi Road,
Kowloon Bay, Kowloon, Hong Kong

[74] HONG KONG INTELLECTUAL PROPERTY ADVISORY SERVICE LIMITED

Unit 1701, 17/F., Ew International Tower,
120 Texaco Road,
Tsuen Wan, New Territories, Hong Kong



[11] 2016321.2

[15] 12-06-2020

[30] 24-04-2020 / CN / 202030173082.6

[51] Cl. 14-03

[54] 手機

Mobile phone

[73] 維沃移動通信有限公司

VIVO MOBILE COMMUNICATION CO.,LTD.

中國內地

廣東省東莞市長安鎮

烏沙步步高大道 283 號

[74] 中國專利代理(香港)有限公司

香港

灣仔港灣道 23 號

鷹君中心 22 字樓



[11] 2016323.6

[15] 12-06-2020

[51] Cl. 23-06

[54] 手部消毒機

Hand sterilizer

[73] 北京春秋科技有限公司

Beijing Chunqiu Technology Co., Ltd

中國內地

北京市北京經濟技術開發區地

盛北街1號院38號樓406室

[74] 香港知識產權代理有限公司

香港新界

白石角香港科學園第三期

科技大道西12號2樓230室





香港特別行政區政府知識產權署外觀設計註冊處

The Government of the Hong Kong Special Administrative Region

Designs Registry, Intellectual Property Department

根據註冊外觀設計條例第 28 條，下列註冊外觀設計因未繳續期費而停止有效。

各組記項按註冊外觀設計停止有效日期及註冊編號先後次序排列。

Registered designs ceased through non-payment of renewal fees under section 28 of the Registered Designs Ordinance. Entries are listed below under their expiry dates.

14-07-2020 - 15-07-2020

14-07-2020

1001275.5

1501535.3

1501536.5

1501537.7M001

1501537.7M002

1501537.7M003

1501537.7M004

1501538.9

15-07-2020

1001303.5

1501540.3M001

1501540.3M002

1501542.7

1501544.1



香港特別行政區政府知識產權署外觀設計註冊處

The Government of the Hong Kong Special Administrative Region

Designs Registry, Intellectual Property Department

根據註冊外觀設計規則第 31 條刪除的註冊外觀設計。各組記項按註冊外觀設計刪除日期及註冊編號先後次序排列。

Registered designs removed under section 31 of the Registered Designs Rules. Entries are listed below under their removal dates.

02-09-2020 - 03-09-2020**02-09-2020**

1500124.9	
1000071.1	1500125.2
1000075.0	1500126.4
1500096.9	1500127.6M001
1500098.3M001	1500127.6M002
1500098.3M002	1500128.8
1500101.1M001	1500129.0
1500101.1M002	1500130.2
1500101.1M003	1500131.4
1500101.1M004	1500132.6
	1500133.8

03-09-2020

1500106.2
1500107.4
1500110.0M001
1500110.0M002
1500110.0M004
1500111.2
1500112.4
1500113.6
1500114.8M001
1500114.8M002
1500114.8M003
1500115.1M001
1500115.1M002
1500115.1M003
1500116.3
1500117.5
1500118.7
1500119.9
1500120.1
1500121.3
1500122.5
1500123.7



香港特別行政區政府知識產權署外觀設計註冊處
The Government of the Hong Kong Special Administrative Region
Designs Registry, Intellectual Property Department

勘誤

CORRIGENDUM

已在官方公報刊登的外觀設計公告內的表述更正如下：

The following show the corrected representations of the designs in advertisement previously published in the official journal:

官方公報日期 Official journal date 11.10.2019

[11] 1900128.2M012

[55] 外觀設計的表述 Representation of the Design

