

香港知識產權公報

Hong Kong Intellectual Property Journal

2021年3月19日

19 March 2021

目錄 Contents

根據註冊外觀設計條例第 25 條註冊的外觀設計

Designs Registered under section 25 of the Registered Designs Ordinance

按註冊編號排列

Arranged by Registration Number

根據註冊外觀設計條例(第 522 章)公布的其他公告

Other Notices Published under the Registered Designs Ordinance (Cap. 522)

根據註冊外觀設計條例第 28 條，註冊外觀設計因未繳續期費而停止有效

Registered designs ceased through non-payment of renewal fees under section 28 of the Registered Designs Ordinance

根據註冊外觀設計規則第 31 條刪除的註冊外觀設計

Registered designs removed under section 31 of the Registered Designs Rules

根據註冊外觀設計條例第 67 及 76 條，更正註冊紀錄冊內及已提交文件中的錯誤

Correction of Errors in Register and in Filed Documents under sections 67 and 76 of the Registered Designs Ordinance

以下事項沒有記錄

No Records for the Following Matters

根據註冊外觀設計條例第 30 條放棄的外觀設計的註冊

Surrender of Registration of Design under section 30 of the Registered Designs Ordinance

根據註冊外觀設計規則第 37 條，向處長作出轉介

Reference to Registrar under section 37 of the Registered Designs Rules

根據註冊外觀設計條例第 45 條，撤銷註冊

Revocation of Registration under section 45 of the Registered Designs Ordinance

根據註冊外觀設計規則第 46 條，向法院作出轉介

Reference to Court under section 46 of the Registered Designs Rules

根據註冊外觀設計規則第 63 條對不符合規定之處作出糾正

Rectification of Irregularities under section 63 of the Registered Designs Rules

根據註冊外觀設計條例第 66 條，糾正註冊紀錄冊

Rectification of Register under section 66 of the Registered Designs Ordinance

根據註冊外觀設計條例第 67 條 更正註冊紀錄冊內的錯誤

Correction of errors in Register under section 67 of the Registered Designs Ordinance

根據註冊外觀設計條例第 76 條，更正已提交文件中的錯誤

Correction of errors in filed documents under section 76 of the Registered Designs Ordinance

勘誤

Corrigendum

註冊外觀設計公告註釋

Notes on advertisements of registration of designs

方括號表示下列資料：

Square brackets indicate the following data：

[11] 註冊編號 Registration number / 聯合王國註冊編號 United Kingdom registration number

[15] 註冊日期 Registration date / 當作註冊日期 Deemed registration date / 聯合王國註冊日期 United Kingdom registration date

[17] 註冊有效期屆滿日期 Expiry date of the period of registration

[22] 提交日期 Filing date / 當作提交日期 Deemed filing date / 聯合王國提交日期 United Kingdom filing date

[30] 聲稱享有的優先權（提交日期 / 巴黎公約國或世界貿易組織成員 / 申請編號） Priority claimed (filing date / Paris Convention country or WTO member / application number)

[51] 國際外觀設計分類號（洛迦諾分類號） International Classification of designs (Locarno Classification)

[54] 物品 Article

[55] 外觀設計的表述 Representation of the design

[62] 分開前的申請編號及提交日期 Application number before division and filing date

[66] 過往註冊的聯繫外觀設計註冊編號 / 日期 Registration No. / Date of Previous Registration for Association

[72] 設計人 Designer

[73] 擁有人姓名和地址 Name and address of the owner

[74] 代理人 Agent / 送達地址 Address for service



香港特別行政區政府知識產權署外觀設計註冊處

The Government of the Hong Kong Special Administrative Region

Designs Registry, Intellectual Property Department

根據註冊外觀設計條例第 25 條註冊的外觀設計

Designs registered under section 25 of the Registered Designs Ordinance

按註冊編號排列

Arranged by Registration Number

[11] 2016973.4M001

[15] 20-10-2020

[30] 30-06-2020 / CN / 202030344315.4

[51] Cl. 14-04

[54] 帶拾音器客戶端圖形用戶界面的顯示設備

Display device with graphical user interface for client side of sound pickup

[73] 阿里巴巴集團控股有限公司

Alibaba Group Holding Limited

開曼群島

英屬開曼群島

大開曼資本大廈一座四層 847 號郵箱

[74] 三友知識產權代理有限公司

香港灣仔

駱克道 160-174 號

越秀大廈 6 樓 601 室



[11] 2016973.4M002

[15] 20-10-2020

[30] 30-06-2020 / CN / 202030344315.4

[51] Cl. 14-04

- [54] 帶拾音器客戶端圖形用戶界面的顯示設備
Display device with graphical user interface for client side of sound pickup
- [73] 阿里巴巴集團控股有限公司
Alibaba Group Holding Limited
開曼群島
英屬開曼群島
大開曼資本大廈一座四層 847 號郵箱
- [74] 三友知識產權代理有限公司
香港灣仔
駱克道 160-174 號
越秀大廈 6 樓 601 室



-
- [11] 2016976.1M001
- [15] 20-10-2020
- [30] 09-06-2020 / CN / 202030289255.0
- [51] Cl. 14-04
- [54] 帶表格切換圖形用戶界面的顯示屏幕面板
Display panel with graphical user interface for table switch
- [73] 阿里巴巴集團控股有限公司
Alibaba Group Holding Limited
開曼群島
英屬開曼群島
大開曼資本大廈一座四層 847 號郵箱
- [74] 三友知識產權代理有限公司
香港灣仔
駱克道 160-174 號
越秀大廈 6 樓 601 室



[11] 2016976.1M002

[15] 20-10-2020

[30] 09-06-2020 / CN / 202030289255.0

[51] Cl. 14-04

[54] 帶表格切換圖形用戶界面的顯示屏幕面板
Display panel with graphical user interface for table switch

[73] 阿里巴巴集團控股有限公司
Alibaba Group Holding Limited
開曼群島
英屬開曼群島
大開曼資本大廈一座四層 847 號郵箱

[74] 三友知識產權代理有限公司
香港灣仔
駱克道 160-174 號
越秀大廈 6 樓 601 室



[11] 2017173.8

[15] 02-12-2020

[30] 12-11-2020 / EU / 008266829-0001

[51] Cl. 16-06

- [54] 眼鏡鉸鏈
Hinges for spectacles
- [73] IZIPIZI
19 rue de Calais,
75009 Paris,
France
- [74] ATL LAW OFFICES
16/F., China Hong Kong Tower,
8-12 Hennessy Road,
Wanchai, Hong Kong



-
- [11] 2117374.5M001
- [15] 05-01-2021
- [30] 08-07-2020 / EU / 008034490
- [51] Cl. 28-03
- [54] 風筒
Hair dryer
- [73] Koninklijke Philips N.V.
High Tech Campus 52,
5656 AG Eindhoven,
Netherlands
- [74] Rouse & Co. International (Overseas) Limited
18/F., Golden Centre,
188 Des Voeux Road Central,
Hong Kong

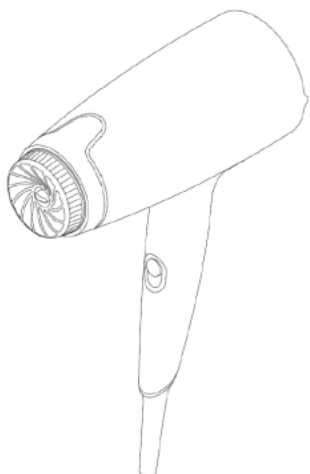

[11] 2117374.5M002

[15] 05-01-2021

[30] 08-07-2020 / EU / 008034490

[51] Cl. 28-03

[54] 風筒

Hair dryer

[73] Koninklijke Philips N.V.

High Tech Campus 52,

5656 AG Eindhoven,

Netherlands

[74] Rouse & Co. International (Overseas) Limited

18/F., Golden Centre,

188 Des Voeux Road Central,

Hong Kong

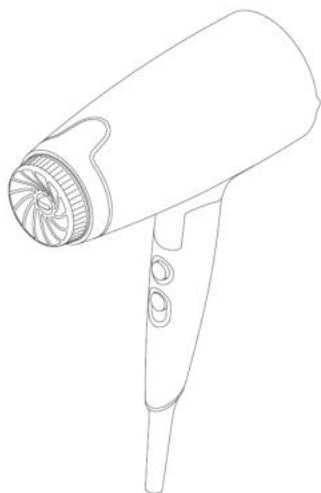

[11] 2117374.5M003

[15] 05-01-2021

[30] 08-07-2020 / EU / 008034490

[51] Cl. 28-03

[54] 風筒

Hair dryer

[73] Koninklijke Philips N.V.

High Tech Campus 52,

5656 AG Eindhoven,

Netherlands

[74] Rouse & Co. International (Overseas) Limited

18/F., Golden Centre,

188 Des Voeux Road Central,

Hong Kong

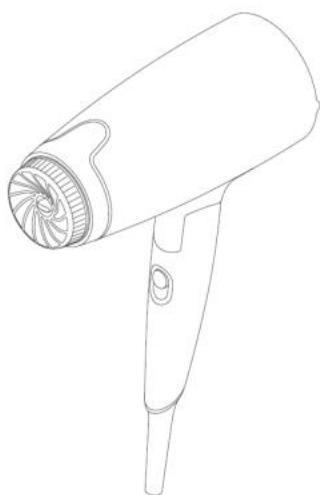

[11] 2117374.5M004

[15] 05-01-2021

[30] 08-07-2020 / EU / 008034490

[51] Cl. 28-03

[54] 風筒

Hair dryer

[73] Koninklijke Philips N.V.

High Tech Campus 52,

5656 AG Eindhoven,

Netherlands

[74] Rouse & Co. International (Overseas) Limited

18/F., Golden Centre,

188 Des Voeux Road Central,

Hong Kong

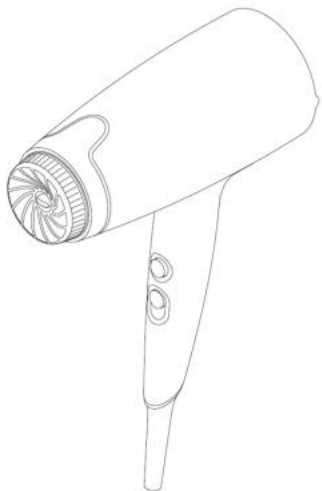

[11] 2117374.5M005

[15] 05-01-2021

[30] 08-07-2020 / EU / 008034490

[51] Cl. 28-03

[54] 風筒的部份

Part of hair dryer

[73] Koninklijke Philips N.V.

High Tech Campus 52,

5656 AG Eindhoven,

Netherlands

[74] Rouse & Co. International (Overseas) Limited

18/F., Golden Centre,

188 Des Voeux Road Central,

Hong Kong

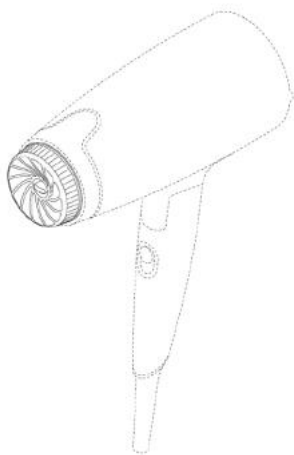

- [11] 2117374.5M006
[15] 05-01-2021
[30] 08-07-2020 / EU / 008034490
[51] Cl. 28-03
[54] 風筒的部份
Part of hair dryer
[73] Koninklijke Philips N.V.
High Tech Campus 52,
5656 AG Eindhoven,
Netherlands
[74] Rouse & Co. International (Overseas) Limited
18/F., Golden Centre,
188 Des Voeux Road Central,
Hong Kong

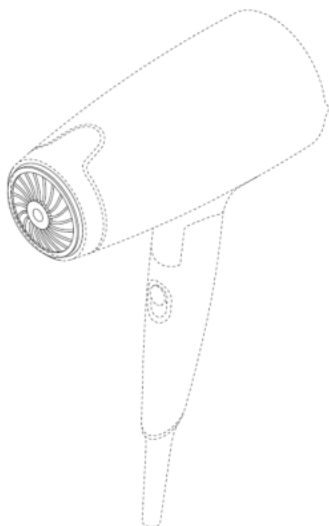

-
- [11] 2117374.5M007
[15] 05-01-2021
[30] 08-07-2020 / EU / 008034490
[51] Cl. 28-03
[54] 風筒的部份
Part of hair dryer
[73] Koninklijke Philips N.V.
High Tech Campus 52,
5656 AG Eindhoven,
Netherlands
[74] Rouse & Co. International (Overseas) Limited
18/F., Golden Centre,
188 Des Voeux Road Central,
Hong Kong

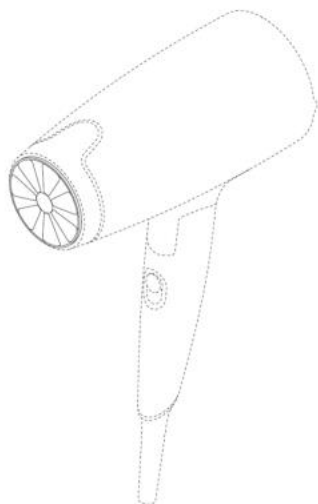

[11] 2117374.5M008

[15] 05-01-2021

[30] 08-07-2020 / EU / 008034490

[51] Cl. 28-03

[54] 風筒的部份

Part of hair dryer

[73] Koninklijke Philips N.V.

High Tech Campus 52,

5656 AG Eindhoven,

Netherlands

[74] Rouse & Co. International (Overseas) Limited

18/F., Golden Centre,

188 Des Voeux Road Central,

Hong Kong

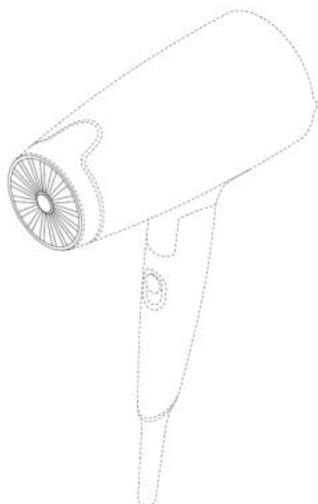

[11] 2117374.5M009

[15] 05-01-2021

[30] 08-07-2020 / EU / 008034490

[51] Cl. 28-03

[54] 風筒的部份

Part of hair dryer

[73] Koninklijke Philips N.V.

High Tech Campus 52,

5656 AG Eindhoven,

Netherlands

[74] Rouse & Co. International (Overseas) Limited

18/F., Golden Centre,

188 Des Voeux Road Central,

Hong Kong

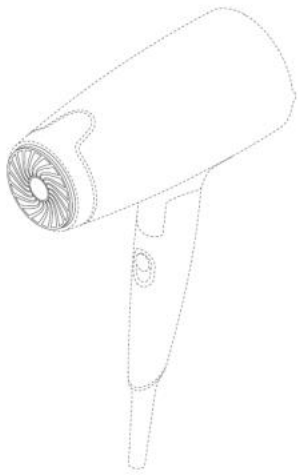

[11] 2117374.5M010

[15] 05-01-2021

[30] 08-07-2020 / EU / 008034490

[51] Cl. 28-03

[54] 風筒的部份

Part of hair dryer

[73] Koninklijke Philips N.V.

High Tech Campus 52,

5656 AG Eindhoven,

Netherlands

[74] Rouse & Co. International (Overseas) Limited

18/F., Golden Centre,

188 Des Voeux Road Central,

Hong Kong

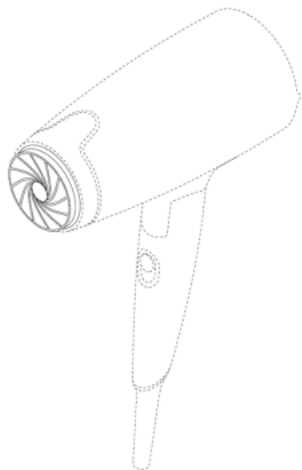

[11] 2117400.2M001

[15] 19-01-2021

[51] Cl. 3-01

[54] 耳機套

Earphone case

[73] 華緻貿易有限公司

Motto Carpe Diem Limited

香港九龍

新蒲崗五芳街 19-21 號

嘉榮工廠大廈 1 樓 C 室

[74] Motto Carpe Diem Limited

香港九龍

新蒲崗五芳街 19-21 號

嘉榮工廠大廈 1 樓 C 室



[11] 2117400.2M002

[15] 19-01-2021

[51] Cl. 3-01

[54] 耳機套

Earphone case

[73] 華緻貿易有限公司

Motto Carpe Diem Limited

香港九龍

新蒲崗五芳街 19-21 號

嘉榮工廠大廈 1 樓 C 室

[74] Motto Carpe Diem Limited

香港九龍

新蒲崗五芳街 19-21 號

嘉榮工廠大廈 1 樓 C 室



[11] 2117469.7M001

[15] 22-01-2021

[30] 21-08-2020 / CA, AM, AZ, BZ, BA, GE, LI, MK, MD, MC, MN, ME, MA, NO, OM, SG, CH, TN, TR, UA, GB, EU, AL, KG / DM/210 120

[51] Cl. 11-01

[54] 指環

Ring

[73] Harry Winston SA

Chemin du Tourbillon 8,

CH-1228 Plan-les-Ouates,

Switzerland

[74] SPRUSON & FERGUSON (HONG KONG) LIMITED

5001 Hopewell Centre,

183 Queen's Road East,

Wan Chai, Hong Kong



[11] 2117469.7M002

[15] 22-01-2021

[30] 21-08-2020 / CA, AM, AZ, BZ, BA, GE, LI, MK, MD, MC, MN, ME, MA, NO, OM, SG, CH, TN, TR, UA, GB, EU, AL, KG / DM/210 120

[51] Cl. 11-01

[54] 耳環

Earrings

[73] Harry Winston SA

Chemin du Tourbillon 8,
CH-1228 Plan-les-Ouates,
Switzerland

[74] SPRUSON & FERGUSON (HONG KONG) LIMITED

5001 Hopewell Centre,
183 Queen's Road East,
Wan Chai, Hong Kong



[11] 2117469.7M003

[15] 22-01-2021

[30] 21-08-2020 / CA, AM, AZ, BZ, BA, GE, LI, MK, MD, MC, MN, ME, MA, NO, OM, SG, CH, TN, TR, UA, GB, EU, AL, KG / DM/210 120

[51] Cl. 11-01

[54] 耳環

Earrings

[73] Harry Winston SA

Chemin du Tourbillon 8,
CH-1228 Plan-les-Ouates,
Switzerland

[74] SPRUSON & FERGUSON (HONG KONG) LIMITED

5001 Hopewell Centre,
183 Queen's Road East,
Wan Chai, Hong Kong



[11] 2117469.7M004

[15] 22-01-2021

[30] 21-08-2020 / CA, AM, AZ, BZ, BA, GE, LI, MK, MD, MC, MN, ME,
MA, NO, OM, SG, CH, TN, TR, UA, GB, EU, AL, KG / DM/210 120

[51] Cl. 11-01

[54] 指環

Ring

[73] Harry Winston SA

Chemin du Tourbillon 8,
CH-1228 Plan-les-Ouates,
Switzerland

[74] SPRUSON & FERGUSON (HONG KONG) LIMITED

5001 Hopewell Centre,
183 Queen's Road East,
Wan Chai, Hong Kong



[11] 2117469.7M005

[15] 22-01-2021

[30] 21-08-2020 / CA, AM, AZ, BZ, BA, GE, LI, MK, MD, MC, MN, ME,
MA, NO, OM, SG, CH, TN, TR, UA, GB, EU, AL, KG / DM/210 120

[51] Cl. 11-01

[54] 項鍊

Necklace

[73] Harry Winston SA

Chemin du Tourbillon 8,
CH-1228 Plan-les-Ouates,
Switzerland

[74] SPRUSON & FERGUSON (HONG KONG) LIMITED

5001 Hopewell Centre,
183 Queen's Road East,
Wan Chai, Hong Kong



[11] 2117469.7M006

[15] 22-01-2021

[30] 21-08-2020 / CA, AM, AZ, BZ, BA, GE, LI, MK, MD, MC, MN, ME, MA, NO, OM, SG, CH, TN, TR, UA, GB, EU, AL, KG / DM/210 120

[51] Cl. 11-01

[54] 項鍊

Necklace

[73] Harry Winston SA

Chemin du Tourbillon 8,
CH-1228 Plan-les-Ouates,
Switzerland

[74] SPRUSON & FERGUSON (HONG KONG) LIMITED

5001 Hopewell Centre,
183 Queen's Road East,
Wan Chai, Hong Kong



[11] 2117469.7M007

[15] 22-01-2021

[30] 21-08-2020 / CA, AM, AZ, BZ, BA, GE, LI, MK, MD, MC, MN, ME, MA, NO, OM, SG, CH, TN, TR, UA, GB, EU, AL, KG / DM/210 120

[51] Cl. 11-01

[54] 項鍊

Necklace

[73] Harry Winston SA

Chemin du Tourbillon 8,
CH-1228 Plan-les-Ouates,
Switzerland

[74] SPRUSON & FERGUSON (HONG KONG) LIMITED

5001 Hopewell Centre,
183 Queen's Road East,
Wan Chai, Hong Kong



[11] 2117470.9M001

[15] 25-01-2021

[30] 29-07-2020 / US / 29/744,463

[51] Cl. 28-03

[54] 緊膚儀

Skin toning device

[73] Carol Cole Company

1325 Sycamore Avenue,

Suite A, Vista, CA 92081,

United States

[74] BIRD & BIRD

6/F, The Annex, Central Plaza,

18 Harbour Road,

Hong Kong

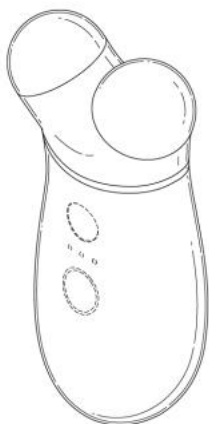

[11] 2117470.9M002

[15] 25-01-2021

[30] 29-07-2020 / US / 29/744,463

[51] Cl. 28-03

[54] 緊膚儀

Skin toning device

[73] Carol Cole Company

1325 Sycamore Avenue,
Suite A, Vista, CA 92081,
United States

[74] BIRD & BIRD

6/F, The Annex, Central Plaza,
18 Harbour Road,
Hong Kong

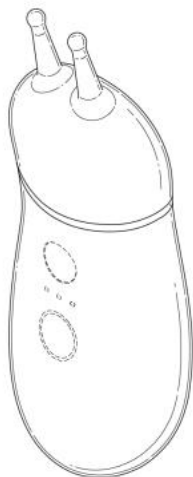

[11] 2117470.9M003

[15] 25-01-2021

[30] 29-07-2020 / US / 29/744,463

[51] Cl. 28-03

[54] 緊膚儀

Skin toning device

[73] Carol Cole Company

1325 Sycamore Avenue,
Suite A, Vista, CA 92081,
United States

[74] BIRD & BIRD

6/F, The Annex, Central Plaza,
18 Harbour Road,
Hong Kong

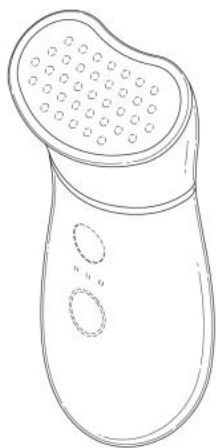

[11] 2117470.9M004

[15] 25-01-2021

[30] 29-07-2020 / US / 29/744,463

[51] Cl. 28-03

[54] 緊膚儀

Skin toning device

[73] Carol Cole Company

1325 Sycamore Avenue,
Suite A, Vista, CA 92081,
United States

[74] BIRD & BIRD

6/F, The Annex, Central Plaza,
18 Harbour Road,
Hong Kong

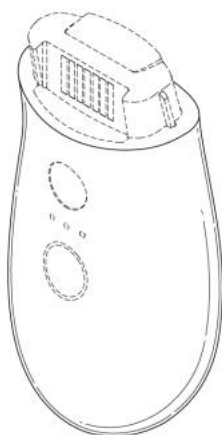

- [11] 2117470.9M005
[15] 25-01-2021
[30] 29-07-2020 / US / 29/744,463
[51] Cl. 28-03
[54] 緊膚儀
Skin toning device
[73] Carol Cole Company
1325 Sycamore Avenue,
Suite A, Vista, CA 92081,
United States
[74] BIRD & BIRD
6/F, The Annex, Central Plaza,
18 Harbour Road,
Hong Kong



-
- [11] 2117471.1M001
[15] 25-01-2021
[51] Cl. 23-04
[54] 香薰機
Aroma diffuser
[73] 璞真生活有限公司
PUZHEN LIFE CO., LTD
Unit 1112-1116, 11/F, Delta House,
3 On Yiu Street,
Shatin, Hong Kong
[74] FEDERATION OF HONG KONG INDUSTRIES
31/F, Billion Plaza,
8 Cheung Yue Street,
Cheung Sha Wan, Kowloon, Hong Kong



[11] 2117471.1M002

[15] 25-01-2021

[51] Cl. 23-04

[54] 香薰機

Aroma diffuser

[73] 璞真生活有限公司

PUZHEN LIFE CO., LTD

Unit 1112-1116, 11/F, Delta House,

3 On Yiu Street,

Shatin, Hong Kong

[74] FEDERATION OF HONG KONG INDUSTRIES

31/F, Billion Plaza,

8 Cheung Yue Street,

Cheung Sha Wan, Kowloon, Hong Kong



[11] 2117473.5M001

[15] 25-01-2021

[51] Cl. 23-04

[54] 香薰機

Aroma diffuser

[73] 盛開蓮花有限公司

Bloomy Lotus Ltd

Unit 4711, 47/F., The Center,

99 Queen's Road Central,

Central, Hong Kong

[74] FEDERATION OF HONG KONG INDUSTRIES

31/F, Billion Plaza,

8 Cheung Yue Street,

Cheung Sha Wan, Kowloon, Hong Kong

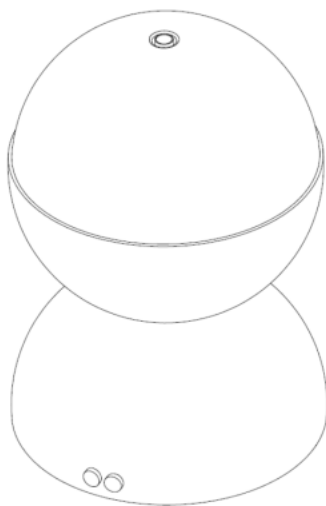

[11] 2117473.5M002

[15] 25-01-2021

[51] Cl. 23-04

[54] 香薰機

Aroma diffuser

[73] 盛開蓮花有限公司

Bloomy Lotus Ltd

Unit 4711, 47/F., The Center,

99 Queen's Road Central,

Central, Hong Kong

[74] FEDERATION OF HONG KONG INDUSTRIES

31/F, Billion Plaza,

8 Cheung Yue Street,

Cheung Sha Wan, Kowloon, Hong Kong

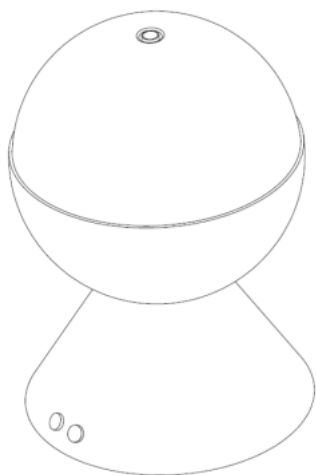

[11] 2117473.5M003

[15] 25-01-2021

[51] Cl. 23-04

[54] 香薰機

Aroma diffuser

[73] 盛開蓮花有限公司

Bloomy Lotus Ltd

Unit 4711, 47/F., The Center,

99 Queen's Road Central,

Central, Hong Kong

[74] FEDERATION OF HONG KONG INDUSTRIES

31/F, Billion Plaza,

8 Cheung Yue Street,

Cheung Sha Wan, Kowloon, Hong Kong

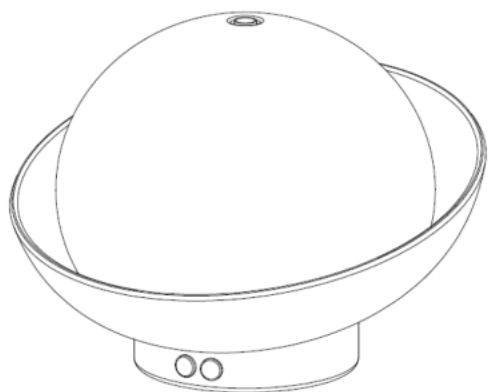

[11] 2117473.5M004

[15] 25-01-2021

[51] Cl. 23-04

[54] 香薰機

Aroma diffuser

[73] 盛開蓮花有限公司

Bloomy Lotus Ltd

Unit 4711, 47/F., The Center,

99 Queen's Road Central,

Central, Hong Kong

[74] FEDERATION OF HONG KONG INDUSTRIES

31/F, Billion Plaza,

8 Cheung Yue Street,

Cheung Sha Wan, Kowloon, Hong Kong

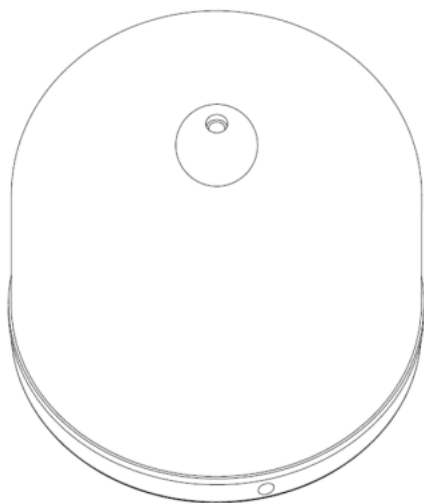

[11] 2117473.5M005

[15] 25-01-2021

[51] Cl. 23-04

[54] 香薰機

Aroma diffuser

[73] 盛開蓮花有限公司

Bloomy Lotus Ltd

Unit 4711, 47/F., The Center,

99 Queen's Road Central,

Central, Hong Kong

[74] FEDERATION OF HONG KONG INDUSTRIES

31/F, Billion Plaza,

8 Cheung Yue Street,

Cheung Sha Wan, Kowloon, Hong Kong

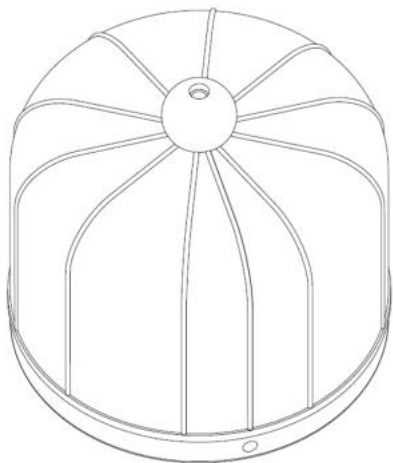

[11] 2117474.7

[15] 25-01-2021

[30] 13-01-2021 / CH, GB, EU / WIPO100909

[51] Cl. 11-01

[54] 珠寶

Jewellery

[73] RICHEMONT INTERNATIONAL SA

Route des biches 10,
1752 Villars-Sur-Glane,
Switzerland

[74] LETTERS & THOO LIMITED

Suite 1008, Prosperity Millennia Plaza,
663 King's Road,
Quarry Bay, Hong Kong

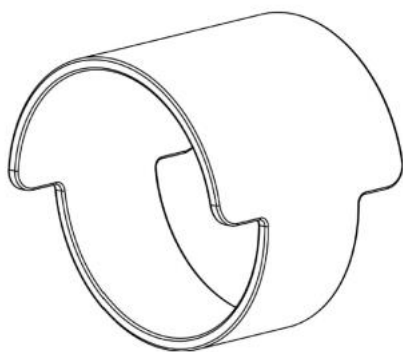

[11] 2117475.0

[15] 25-01-2021

[30] 07-12-2020 / CN / 202030750183.5

[51] Cl. 14-06

[54] 無線充電支架

Wireless charging holder

[73] 廣東高普達集團股份有限公司

GUANGDONG GOPOD GROUP HOLDING CO., LTD

中國內地

廣東省深圳市龍華新區大浪街道同勝社區華榮路

聯建科技工業園廠房 8 棟 4,5,6 樓

[74] 中一聯合國際知識產權有限公司

香港九龍

尖沙咀漆咸道南 45-51 號

其士大廈 803 室

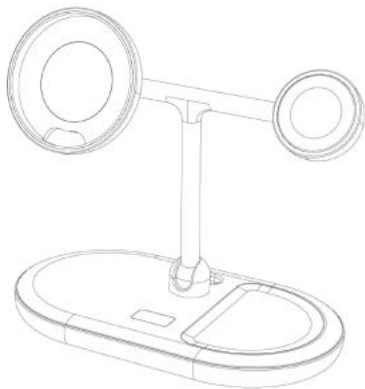

[11] 2117476.2

[15] 25-01-2021

[30] 13-11-2020 / CN / 202030689125.6

[51] Cl. 14-06

[54] 無線充電支架

Wireless charging holder

[73] 廣東高普達集團股份有限公司

GUANGDONG GOPOD GROUP HOLDING CO., LTD

中國內地

廣東省深圳市龍華新區大浪街道同勝社區華榮路

聯建科技工業園廠房 8 棟 4,5,6 樓

[74] 中一聯合國際知識產權有限公司

香港九龍

尖沙咀漆咸道南 45-51 號

其士大廈 803 室

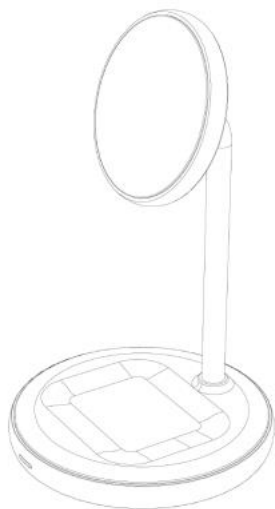

[11] 2117477.4

[15] 25-01-2021

[30] 23-12-2020 / CN / 202030796306.9

[51] C1. 14-06

[54] 平板電腦支架

Tablet holder

[73] 前海駿達（深圳）股權投資有限公司

QIANHAI JUNDA (SHENZHEN) EQUITY INVESTMENT CO., LTD.

中國內地

廣東省深圳市龍華新區大浪街道同勝社區華榮路

聯建科技工業園廠房 8 棟 4, 5, 6 樓

[74] 中一聯合國際知識產權有限公司

香港九龍

尖沙咀漆咸道南 45-51 號

其士大廈 803 室

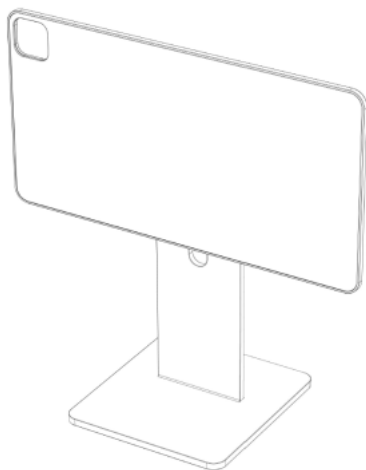

- [11] 2117478.6
[15] 26-01-2021
[51] Cl. 9-03
[54] 包裝盒
Packaging box
[73] 內蒙古蒙牛乳業（集團）股份有限公司
INNER MONGOLIA MENGNIU DAIRY (GROUP) CO., LTD.
中國內地
內蒙古自治區
呼和浩特市和林格爾盛樂經濟園區 011500
[74] 卓遠知識產權有限公司
香港上環
禧利街 27 號
富輝商業中心 10 樓



-
- [11] 2117479.8
[15] 26-01-2021
[30] 29-07-2020 / CA, EG, MX, MC, MA, NO, RU, SG, CH, TN, TR, UA,
GB, US, VN, EU, JP, KR / DM/209 651
[51] Cl. 3-01
[54] 肩袋
Shoulder bag
[73] HERMES SELLIER
24, Rue du Faubourg Saint-Honoré,
75008 Paris,
France
[74] DEACONS
5th Floor, Alexandra House,

Central,
Hong Kong



[11] 2117480.0

[15] 26-01-2021

[30] 01-09-2020 / AR / 97848

[51] Cl. 28-03

[54] 吹風機

Hair dryer

[73] 伽馬有限公司

GA.MA S.R.L. UNIPERSONALE

Via Sant'Alberto, 1714,

40018 San Pietro In Casale, Bologna,

Italia, Italy

[74] DELONG INTELLECTUAL PROPERTY GROUP (HONG KONG) CO., LIMITED

Unit E, 10th Floor, CNT Tower,

No. 338 Hennessy Road,

Wan Chai, Hong Kong



[11] 2117481.2M001

[15] 26-01-2021

[51] Cl. 19-01

Cl. 19-03

Cl. 19-04

Cl. 19-08

[54] 印刷品

Printed matter

[73] BESTIME INTERNATIONAL TRADING LIMITED

Flat 1, 22/F Assun Pacific Centre,

No. 41 Tsun Yip Street,

Kwun Tong, Kowloon, Hong Kong

[74] IPMS CONSULTANTS LIMITED

Unit 2004B, 20/F, Tower 5, China Hong Kong City,

33 Canton Road,

Tsim Sha Tsui, Kowloon, Hong Kong



[11] 2117481.2M002

[15] 26-01-2021

[51] Cl. 19-01

Cl. 19-03

Cl. 19-04

Cl. 19-08

[54] 印刷品

Printed matter

[73] BESTIME INTERNATIONAL TRADING LIMITED

Flat 1, 22/F Assun Pacific Centre,

No. 41 Tsun Yip Street,

Kwun Tong, Kowloon, Hong Kong

[74] IPMS CONSULTANTS LIMITED

Unit 2004B, 20/F, Tower 5, China Hong Kong City,

33 Canton Road,
Tsim Sha Tsui, Kowloon, Hong Kong



[11] 2117481.2M003

[15] 26-01-2021

[51] Cl. 19-01

Cl. 19-03

Cl. 19-04

Cl. 19-08

[54] 印刷品

Printed matter

[73] BESTIME INTERNATIONAL TRADING LIMITED

Flat 1, 22/F Assun Pacific Centre,

No. 41 Tsun Yip Street,

Kwun Tong, Kowloon, Hong Kong

[74] IPMS CONSULTANTS LIMITED

Unit 2004B, 20/F, Tower 5, China Hong Kong City,

33 Canton Road,

Tsim Sha Tsui, Kowloon, Hong Kong



[11] 2117481.2M004

[15] 26-01-2021

[51] Cl. 19-01
Cl. 19-03
Cl. 19-04
Cl. 19-08

[54] 印刷品
Printed matter

[73] BESTIME INTERNATIONAL TRADING LIMITED
Flat 1, 22/F Assun Pacific Centre,
No. 41 Tsun Yip Street,
Kwun Tong, Kowloon, Hong Kong

[74] IPMS CONSULTANTS LIMITED
Unit 2004B, 20/F, Tower 5, China Hong Kong City,
33 Canton Road,
Tsim Sha Tsui, Kowloon, Hong Kong



[11] 2117481.2M005

[15] 26-01-2021

[51] Cl. 19-01
Cl. 19-03
Cl. 19-04
Cl. 19-08

[54] 印刷品
Printed matter

[73] BESTIME INTERNATIONAL TRADING LIMITED
Flat 1, 22/F Assun Pacific Centre,
No. 41 Tsun Yip Street,
Kwun Tong, Kowloon, Hong Kong

[74] IPMS CONSULTANTS LIMITED
Unit 2004B, 20/F, Tower 5, China Hong Kong City,
33 Canton Road,
Tsim Sha Tsui, Kowloon, Hong Kong



[11] 2117481.2M006

[15] 26-01-2021

[51] Cl. 19-01

Cl. 19-03

Cl. 19-04

Cl. 19-08

[54] 印刷品

Printed matter

[73] BESTIME INTERNATIONAL TRADING LIMITED

Flat 1, 22/F Assun Pacific Centre,

No. 41 Tsun Yip Street,

Kwun Tong, Kowloon, Hong Kong

[74] IPMS CONSULTANTS LIMITED

Unit 2004B, 20/F, Tower 5, China Hong Kong City,

33 Canton Road,

Tsim Sha Tsui, Kowloon, Hong Kong



[11] 2117481.2M007

[15] 26-01-2021

[51] Cl. 19-01

Cl. 19-03

Cl. 19-04

Cl. 19-08

[54] 印刷品

Printed matter

[73] BESTIME INTERNATIONAL TRADING LIMITED

Flat 1, 22/F Assun Pacific Centre,
No. 41 Tsun Yip Street,
Kwun Tong, Kowloon, Hong Kong

[74] IPMS CONSULTANTS LIMITED

Unit 2004B, 20/F, Tower 5, China Hong Kong City,
33 Canton Road,
Tsim Sha Tsui, Kowloon, Hong Kong



[11] 2117481.2M008

[15] 26-01-2021

[51] Cl. 19-01

Cl. 19-03

Cl. 19-04

Cl. 19-08

[54] 印刷品

Printed matter

[73] BESTIME INTERNATIONAL TRADING LIMITED

Flat 1, 22/F Assun Pacific Centre,
No. 41 Tsun Yip Street,
Kwun Tong, Kowloon, Hong Kong

[74] IPMS CONSULTANTS LIMITED

Unit 2004B, 20/F, Tower 5, China Hong Kong City,
33 Canton Road,
Tsim Sha Tsui, Kowloon, Hong Kong



[11] 2117481.2M009

[15] 26-01-2021

[51] Cl. 19-01

Cl. 19-03

Cl. 19-04

Cl. 19-08

[54] 印刷品

Printed matter

[73] BESTIME INTERNATIONAL TRADING LIMITED

Flat 1, 22/F Assun Pacific Centre,

No. 41 Tsun Yip Street,

Kwun Tong, Kowloon, Hong Kong

[74] IPMS CONSULTANTS LIMITED

Unit 2004B, 20/F, Tower 5, China Hong Kong City,

33 Canton Road,

Tsim Sha Tsui, Kowloon, Hong Kong



[11] 2117481.2M010

[15] 26-01-2021

[51] Cl. 19-01

Cl. 19-03

Cl. 19-04

Cl. 19-08

[54] 印刷品

Printed matter

[73] BESTIME INTERNATIONAL TRADING LIMITED

Flat 1, 22/F Assun Pacific Centre,

No. 41 Tsun Yip Street,

Kwun Tong, Kowloon, Hong Kong

[74] IPMS CONSULTANTS LIMITED

Unit 2004B, 20/F, Tower 5, China Hong Kong City,

33 Canton Road,

Tsim Sha Tsui, Kowloon, Hong Kong



[11] 2117481.2M011

[15] 26-01-2021

[51] Cl. 19-01

Cl. 19-03

Cl. 19-04

Cl. 19-08

[54] 印刷品

Printed matter

[73] BESTIME INTERNATIONAL TRADING LIMITED

Flat 1, 22/F Assun Pacific Centre,

No. 41 Tsun Yip Street,

Kwun Tong, Kowloon, Hong Kong

[74] IPMS CONSULTANTS LIMITED

Unit 2004B, 20/F, Tower 5, China Hong Kong City,

33 Canton Road,

Tsim Sha Tsui, Kowloon, Hong Kong



[11] 2117481.2M012

[15] 26-01-2021

[51] Cl. 19-01

Cl. 19-03

Cl. 19-04

Cl. 19-08

[54] 印刷品

Printed matter

[73] BESTIME INTERNATIONAL TRADING LIMITED

Flat 1, 22/F Assun Pacific Centre,

No. 41 Tsun Yip Street,

Kwun Tong, Kowloon, Hong Kong

[74] IPMS CONSULTANTS LIMITED

Unit 2004B, 20/F, Tower 5, China Hong Kong City,

33 Canton Road,

Tsim Sha Tsui, Kowloon, Hong Kong



[11] 2117481.2M013

[15] 26-01-2021

[51] Cl. 19-01

Cl. 19-03

Cl. 19-04

Cl. 19-08

[54] 印刷品

Printed matter

[73] BESTIME INTERNATIONAL TRADING LIMITED

Flat 1, 22/F Assun Pacific Centre,
No. 41 Tsun Yip Street,
Kwun Tong, Kowloon, Hong Kong

[74] IPMS CONSULTANTS LIMITED

Unit 2004B, 20/F, Tower 5, China Hong Kong City,
33 Canton Road,
Tsim Sha Tsui, Kowloon, Hong Kong



[11] 2117481.2M014

[15] 26-01-2021

[51] Cl. 19-01

Cl. 19-03

Cl. 19-04

Cl. 19-08

[54] 印刷品

Printed matter

[73] BESTIME INTERNATIONAL TRADING LIMITED

Flat 1, 22/F Assun Pacific Centre,
No. 41 Tsun Yip Street,
Kwun Tong, Kowloon, Hong Kong

[74] IPMS CONSULTANTS LIMITED

Unit 2004B, 20/F, Tower 5, China Hong Kong City,
33 Canton Road,
Tsim Sha Tsui, Kowloon, Hong Kong



[11] 2117481.2M015

[15] 26-01-2021

[51] Cl. 19-01

Cl. 19-03

Cl. 19-04

Cl. 19-08

[54] 印刷品

Printed matter

[73] BESTIME INTERNATIONAL TRADING LIMITED

Flat 1, 22/F Assun Pacific Centre,

No. 41 Tsun Yip Street,

Kwun Tong, Kowloon, Hong Kong

[74] IPMS CONSULTANTS LIMITED

Unit 2004B, 20/F, Tower 5, China Hong Kong City,

33 Canton Road,

Tsim Sha Tsui, Kowloon, Hong Kong



[11] 2117483.6M001

[15] 26-01-2021

[51] Cl. 19-01

Cl. 19-03

Cl. 19-04

Cl. 19-08

[54] 印刷品

Printed matter

[73] BESTIME INTERNATIONAL TRADING LIMITED

Flat 1, 22/F Assun Pacific Centre,
No. 41 Tsun Yip Street,
Kwun Tong, Kowloon, Hong Kong

[74] IPMS CONSULTANTS LIMITED

Unit 2004B, 20/F, Tower 5, China Hong Kong City,
33 Canton Road,
Tsim Sha Tsui, Kowloon, Hong Kong

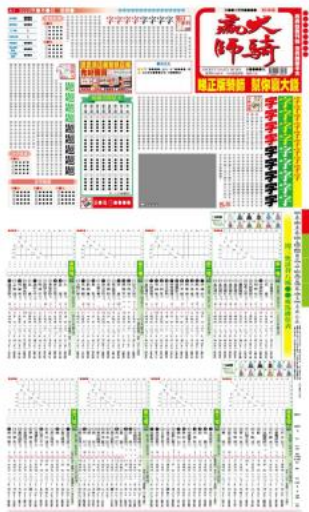

[11] 2117483.6M002

[15] 26-01-2021

[51] Cl. 19-01

Cl. 19-03

Cl. 19-04

Cl. 19-08

[54] 印刷品

Printed matter

[73] BESTIME INTERNATIONAL TRADING LIMITED

Flat 1, 22/F Assun Pacific Centre,
No. 41 Tsun Yip Street,
Kwun Tong, Kowloon, Hong Kong

[74] IPMS CONSULTANTS LIMITED

Unit 2004B, 20/F, Tower 5, China Hong Kong City,
33 Canton Road,
Tsim Sha Tsui, Kowloon, Hong Kong

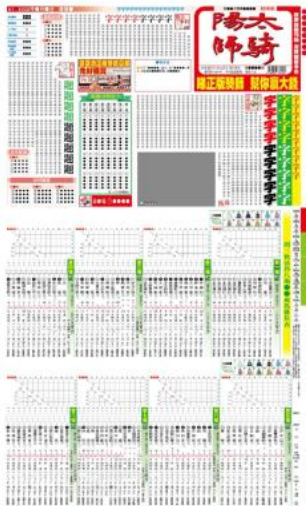

[11] 2117483.6M003

[15] 26-01-2021

[51] Cl. 19-01

Cl. 19-03

Cl. 19-04

Cl. 19-08

[54] 印刷品

Printed matter

[73] BESTIME INTERNATIONAL TRADING LIMITED

Flat 1, 22/F Assun Pacific Centre,

No. 41 Tsun Yip Street,

Kwun Tong, Kowloon, Hong Kong

[74] IPMS CONSULTANTS LIMITED

Unit 2004B, 20/F, Tower 5, China Hong Kong City,

33 Canton Road,

Tsim Sha Tsui, Kowloon, Hong Kong

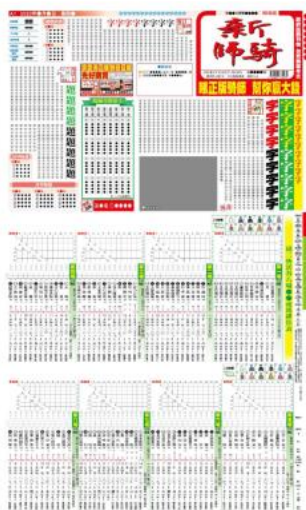

[11] 2117483.6M004

[15] 26-01-2021

[51] Cl. 19-01

Cl. 19-03

Cl. 19-04

Cl. 19-08

[54] 印刷品

Printed matter

[73] BESTIME INTERNATIONAL TRADING LIMITED

Flat 1, 22/F Assun Pacific Centre,

No. 41 Tsun Yip Street,

Kwun Tong, Kowloon, Hong Kong

[74] IPMS CONSULTANTS LIMITED

Unit 2004B, 20/F, Tower 5, China Hong Kong City,

33 Canton Road,

Tsim Sha Tsui, Kowloon, Hong Kong

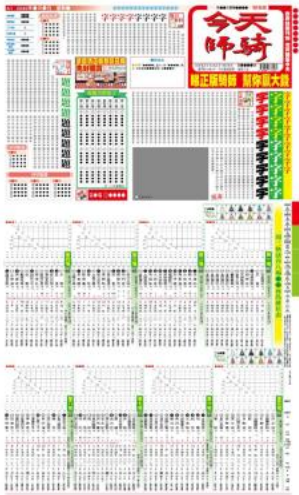

[11] 2117483.6M005

[15] 26-01-2021

[51] Cl. 19-01

Cl. 19-03

Cl. 19-04

Cl. 19-08

[54] 印刷品

Printed matter

[73] BESTIME INTERNATIONAL TRADING LIMITED

Flat 1, 22/F Assun Pacific Centre,

No. 41 Tsun Yip Street,

Kwun Tong, Kowloon, Hong Kong

- [74] IPMS CONSULTANTS LIMITED
Unit 2004B, 20/F, Tower 5, China Hong Kong City,
33 Canton Road,
Tsim Sha Tsui, Kowloon, Hong Kong

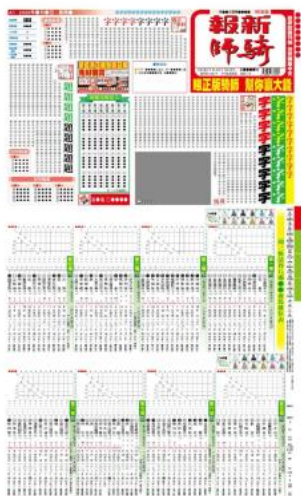

-
- [11] 2117483.6M006
[15] 26-01-2021
[51] Cl. 19-01
Cl. 19-03
Cl. 19-04
Cl. 19-08
[54] 印刷品
Printed matter
[73] BESTIME INTERNATIONAL TRADING LIMITED
Flat 1, 22/F Assun Pacific Centre,
No. 41 Tsun Yip Street,
Kwun Tong, Kowloon, Hong Kong
[74] IPMS CONSULTANTS LIMITED
Unit 2004B, 20/F, Tower 5, China Hong Kong City,
33 Canton Road,
Tsim Sha Tsui, Kowloon, Hong Kong

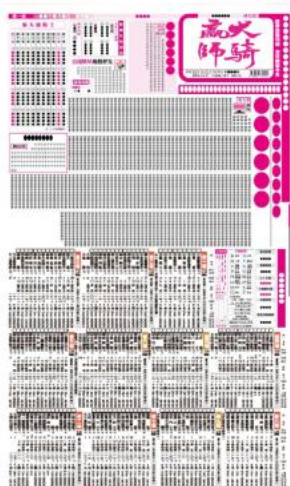

[11] 2117483.6M007

[15] 26-01-2021

[51] Cl. 19-01

Cl. 19-03

Cl. 19-04

Cl. 19-08

[54] 印刷品

Printed matter

[73] BESTIME INTERNATIONAL TRADING LIMITED

Flat 1, 22/F Assun Pacific Centre,

No. 41 Tsun Yip Street,

Kwun Tong, Kowloon, Hong Kong

[74] IPMS CONSULTANTS LIMITED

Unit 2004B, 20/F, Tower 5, China Hong Kong City,

33 Canton Road,

Tsim Sha Tsui, Kowloon, Hong Kong

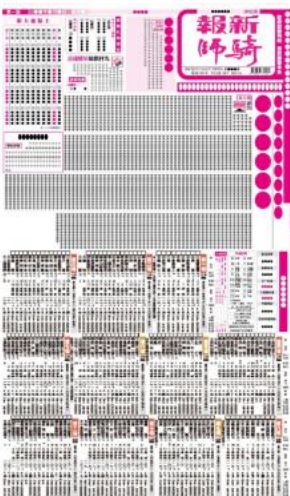

[11] 2117483.6M008

[15] 26-01-2021

[51] Cl. 19-01

Cl. 19-03

Cl. 19-04

Cl. 19-08

[54] 印刷品

Printed matter

[73] BESTIME INTERNATIONAL TRADING LIMITED

Flat 1, 22/F Assun Pacific Centre,

No. 41 Tsun Yip Street,

Kwun Tong, Kowloon, Hong Kong

[74] IPMS CONSULTANTS LIMITED

Unit 2004B, 20/F, Tower 5, China Hong Kong City,

33 Canton Road,

Tsim Sha Tsui, Kowloon, Hong Kong

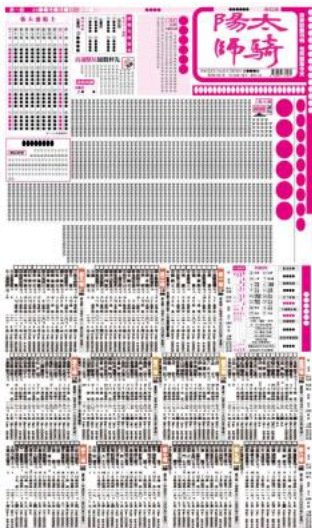

[11] 2117483.6M009

[15] 26-01-2021

[51] Cl. 19-01

Cl. 19-03

Cl. 19-04

Cl. 19-08

[54] 印刷品

Printed matter

[73] BESTIME INTERNATIONAL TRADING LIMITED

Flat 1, 22/F Assun Pacific Centre,

No. 41 Tsun Yip Street,

Kwun Tong, Kowloon, Hong Kong

- [74] IPMS CONSULTANTS LIMITED
Unit 2004B, 20/F, Tower 5, China Hong Kong City,
33 Canton Road,
Tsim Sha Tsui, Kowloon, Hong Kong

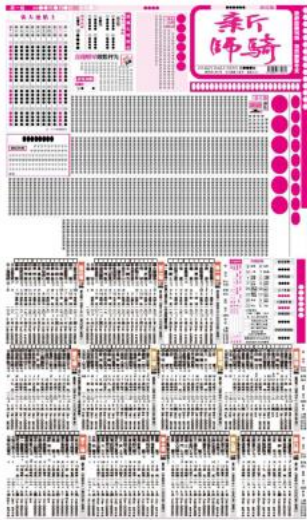

-
- [11] 2117483.6M010
[15] 26-01-2021
[51] Cl. 19-01
Cl. 19-03
Cl. 19-04
Cl. 19-08
[54] 印刷品
Printed matter
[73] BESTIME INTERNATIONAL TRADING LIMITED
Flat 1, 22/F Assun Pacific Centre,
No. 41 Tsun Yip Street,
Kwun Tong, Kowloon, Hong Kong
[74] IPMS CONSULTANTS LIMITED
Unit 2004B, 20/F, Tower 5, China Hong Kong City,
33 Canton Road,
Tsim Sha Tsui, Kowloon, Hong Kong

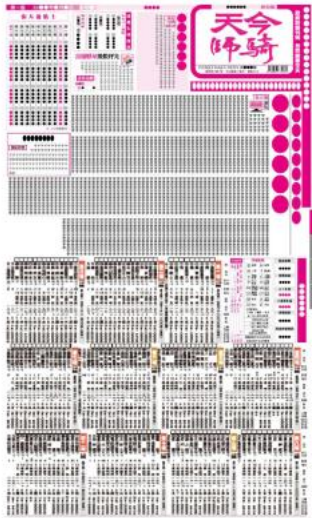

[11] 2117483.6M011

[15] 26-01-2021

[51] Cl. 19-01

Cl. 19-03

Cl. 19-04

Cl. 19-08

[54] 印刷品

Printed matter

[73] BESTIME INTERNATIONAL TRADING LIMITED

Flat 1, 22/F Assun Pacific Centre,

No. 41 Tsun Yip Street,

Kwun Tong, Kowloon, Hong Kong

[74] IPMS CONSULTANTS LIMITED

Unit 2004B, 20/F, Tower 5, China Hong Kong City,

33 Canton Road,

Tsim Sha Tsui, Kowloon, Hong Kong



- [11] 2117484.8
[15] 26-01-2021
[30] 31-12-2020 / CN / 202030827512.1
[51] Cl. 14-06
[54] 平板電腦支架
Tablet holder
[73] 前海駿達（深圳）股權投資有限公司
QIANHAI JUNDA (SHENZHEN) EQUITY INVESTMENT CO., LTD.
中國內地
廣東省深圳市龍華新區大浪街道同勝社區華榮路
聯建科技工業園廠房 8 棟 4,5,6 樓
[74] 中一聯合國際知識產權有限公司
香港九龍
尖沙咀漆咸道南 45-51 號
其士大廈 803 室

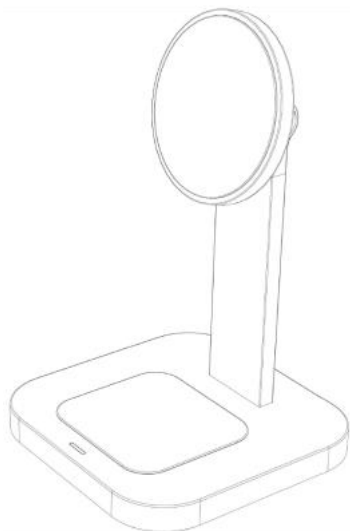

-
- [11] 2117486.3
[15] 27-01-2021
[51] Cl. 9-01
[54] 帶包裝的飲料瓶
Beverage bottle with packaging
[73] 內蒙古蒙牛乳業（集團）股份有限公司
INNER MONGOLIA MENGNIU DAIRY (GROUP) CO., LTD.
中國內地
內蒙古自治區呼和浩特市和林格爾盛樂經濟園區 011500
[74] 卓遠知識產權有限公司
香港上環

禧利街 27 號
富輝商業中心 10 樓



[11] 2117487.5M001

[15] 27-01-2021

[30] 27-07-2020 / EU / 008053227-0001

[51] Cl. 12-11

[54] 電動滑板車

Motor scooter

[73] 博爾特技術有限公司

Bolt Technology OÜ

Vana-Louna tn 15, ESTONIA,

EE-10134 Tallinn,

Estonia

[74] BORSAM INTELLECTUAL PROPERTY LIMITED

Room 605, 6/F, Fa Yuen Commercial Building,

75-77 Fa Yuen Street,

Mongkok, Kowloon, Hong Kong



- [11] 2117487.5M002
[15] 27-01-2021
[30] 27-07-2020 / EU / 008053227-0002
[51] Cl. 12-11
[54] 電動滑板車
Motor scooter
[73] 博爾特技術有限公司
Bolt Technology OÜ
Vana-Louna tn 15, ESTONIA,
EE-10134 Tallinn,
Estonia
[74] BORSAM INTELLECTUAL PROPERTY LIMITED
Room 605, 6/F, Fa Yuen Commercial Building,
75-77 Fa Yuen Street,
Mongkok, Kowloon, Hong Kong



-
- [11] 2117491.3
[15] 27-01-2021
[51] Cl. 10-02
[54] 手錶
Watch
[73] 萬希泉鐘錶有限公司
香港柴灣
永泰道 60 號
柴灣工業城第一期 8 樓 804 室
[74] 萬希泉鐘錶有限公司
香港柴灣
永泰道 60 號
柴灣工業城第一期 8 樓 804 室



[11] 2117492.5

[15] 28-01-2021

[51] Cl. 2-02

[54] 紮手帶

Handwrap

[73] Wong Wai Lung trading as 8 Boxing Equipment Centre

Room 3614, 36/F, Kar Yam House,

On Yam Estate,

Kwai Chung, Hong Kong

[74] ACCOLADE IP LIMITED

10/F, Fu Fai Comm. Ctr.,

27 Hillier Street,

Sheung Wan, Hong Kong



[11] 2117493.7M001

[15] 28-01-2021

[30] 29-07-2020 / US / 29/744,457

[51] Cl. 11-01

[54] 珠寶

Jewelry

[73] Tiffany and Company
727 5th Avenue,
New York 10022,
United States

[74] ROBIN BRIDGE & JOHN LIU
6th Floor, Emperor Commercial Centre,
39 Des Voeux Road Central,
Hong Kong

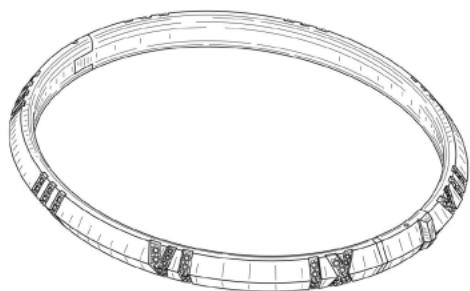

[11] 2117493.7M002

[15] 28-01-2021

[30] 29-07-2020 / US / 29/744,457

[51] Cl. 11-01

[54] 珠寶
Jewelry

[73] Tiffany and Company
727 5th Avenue,
New York 10022,
United States

[74] ROBIN BRIDGE & JOHN LIU
6th Floor, Emperor Commercial Centre,
39 Des Voeux Road Central,
Hong Kong

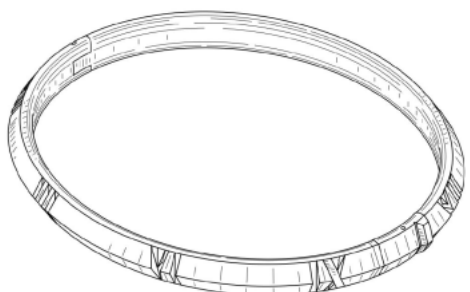

[11] 2117493.7M003

[15] 28-01-2021

[30] 29-07-2020 / US / 29/744,457

[51] Cl. 11-01

[54] 珠寶

Jewelry

[73] Tiffany and Company

727 5th Avenue,

New York 10022,

United States

[74] ROBIN BRIDGE & JOHN LIU

6th Floor, Emperor Commercial Centre,

39 Des Voeux Road Central,

Hong Kong



[11] 2117493.7M004

[15] 28-01-2021

[30] 29-07-2020 / US / 29/744,457

[51] Cl. 11-01

[54] 珠寶

Jewelry

[73] Tiffany and Company

727 5th Avenue,

New York 10022,

United States

[74] ROBIN BRIDGE & JOHN LIU

6th Floor, Emperor Commercial Centre,

39 Des Voeux Road Central,

Hong Kong

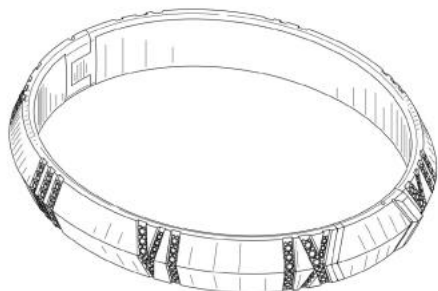

[11] 2117494.9M001

[15] 28-01-2021

[30] 29-07-2020 / US / 29/744,434

[51] Cl. 11-01

[54] 珠寶

Jewelry

[73] Tiffany and Company

727 5th Avenue,

New York 10022,

United States

[74] ROBIN BRIDGE & JOHN LIU

6th Floor, Emperor Commercial Centre,

39 Des Voeux Road Central,

Hong Kong

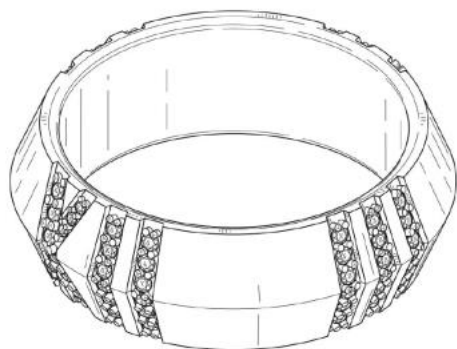

[11] 2117494.9M002

[15] 28-01-2021

[30] 29-07-2020 / US / 29/744,434

[51] Cl. 11-01

[54] 珠寶

Jewelry

[73] Tiffany and Company
727 5th Avenue,
New York 10022,
United States

[74] ROBIN BRIDGE & JOHN LIU
6th Floor, Emperor Commercial Centre,
39 Des Voeux Road Central,
Hong Kong



[11] 2117494.9M003

[15] 28-01-2021

[30] 29-07-2020 / US / 29/744,434

[51] Cl. 11-01

[54] 珠寶
Jewelry

[73] Tiffany and Company
727 5th Avenue,
New York 10022,
United States

[74] ROBIN BRIDGE & JOHN LIU
6th Floor, Emperor Commercial Centre,
39 Des Voeux Road Central,
Hong Kong

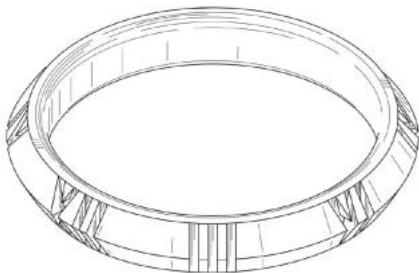

[11] 2117494.9M004

[15] 28-01-2021

[30] 29-07-2020 / US / 29/744,434

[51] Cl. 11-01

[54] 珠寶

Jewelry

[73] Tiffany and Company

727 5th Avenue,

New York 10022,

United States

[74] ROBIN BRIDGE & JOHN LIU

6th Floor, Emperor Commercial Centre,

39 Des Voeux Road Central,

Hong Kong



[11] 2117495.2M001

[15] 28-01-2021

[30] 29-07-2020 / US / 29/744,430

[51] Cl. 11-01

[54] 珠寶

Jewelry

[73] Tiffany and Company

727 5th Avenue,

New York 10022,

United States

[74] ROBIN BRIDGE & JOHN LIU

6th Floor, Emperor Commercial Centre,

39 Des Voeux Road Central,

Hong Kong



[11] 2117495.2M002

[15] 28-01-2021

[30] 29-07-2020 / US / 29/744,430

[51] Cl. 11-01

[54] 珠寶

Jewelry

[73] Tiffany and Company

727 5th Avenue,

New York 10022,

United States

[74] ROBIN BRIDGE & JOHN LIU

6th Floor, Emperor Commercial Centre,

39 Des Voeux Road Central,

Hong Kong



[11] 2117495.2M003

- [15] 28-01-2021
[30] 29-07-2020 / US / 29/744,430
[51] Cl. 11-01
[54] 珠寶
Jewelry
[73] Tiffany and Company
727 5th Avenue,
New York 10022,
United States
[74] ROBIN BRIDGE & JOHN LIU
6th Floor, Emperor Commercial Centre,
39 Des Voeux Road Central,
Hong Kong



-
- [11] 2117495.2M004
[15] 28-01-2021
[30] 29-07-2020 / US / 29/744,430
[51] Cl. 11-01
[54] 珠寶
Jewelry
[73] Tiffany and Company
727 5th Avenue,
New York 10022,
United States
[74] ROBIN BRIDGE & JOHN LIU
6th Floor, Emperor Commercial Centre,
39 Des Voeux Road Central,
Hong Kong

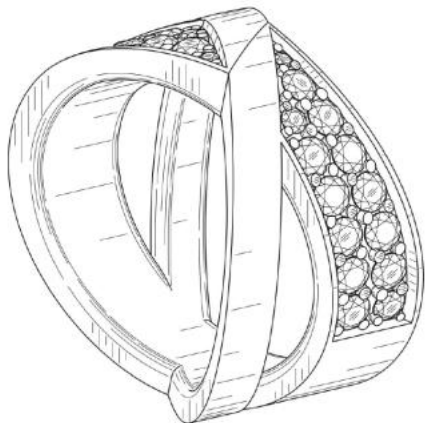

[11] 2117497.6M001

[15] 28-01-2021

[30] 28-07-2020 / US / 29/744,235

[51] Cl. 9-01

[54] 具有附接的施用器的化妝品瓶

Cosmetic bottle with attached applicator

[73] ELC MANAGEMENT LLC

155 Pinelawn Road, Suite 345 South,
Melville, NY 11747,
United States

[74] CHINA PATENT AGENT (HONG KONG) LIMITED

22/F, Great Eagle Centre,
23 Harbour Road,
Wanchai, Hong Kong

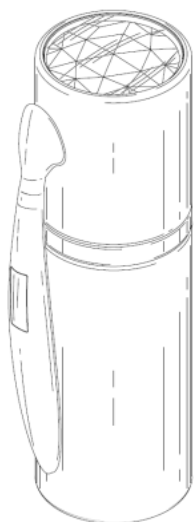

[11] 2117497.6M002

[15] 28-01-2021

[30] 28-07-2020 / US / 29/744,235

[51] Cl. 9-01

[54] 化妝品瓶

Cosmetic bottle

[73] ELC MANAGEMENT LLC

155 Pinelawn Road, Suite 345 South,

Melville, NY 11747,

United States

[74] CHINA PATENT AGENT (HONG KONG) LIMITED

22/F, Great Eagle Centre,

23 Harbour Road,

Wanchai, Hong Kong

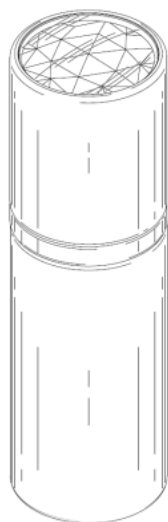

[11] 2117497.6M003

[15] 28-01-2021

[30] 28-07-2020 / US / 29/744,235

[51] Cl. 9-01

[54] 施用器

Applicator

[73] ELC MANAGEMENT LLC

155 Pinelawn Road, Suite 345 South,

Melville, NY 11747,

United States

[74] CHINA PATENT AGENT (HONG KONG) LIMITED

22/F, Great Eagle Centre,

23 Harbour Road,

Wanchai, Hong Kong



[11] 2117497.6M004

[15] 28-01-2021

[30] 28-07-2020 / US / 29/744,235

[51] Cl. 9-01

[54] 化妝品瓶

Cosmetic bottle

[73] ELC MANAGEMENT LLC

155 Pinelawn Road, Suite 345 South,
Melville, NY 11747,
United States

[74] CHINA PATENT AGENT (HONG KONG) LIMITED

22/F, Great Eagle Centre,
23 Harbour Road,
Wanchai, Hong Kong

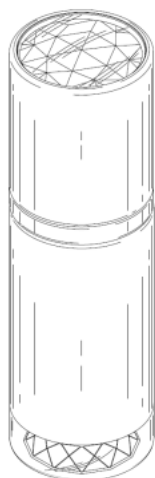

[11] 2117498.8

[15] 28-01-2021

[51] Cl. 9-03

[54] 消毒液瓶套

Disinfectant bottle case

[73] 摩理都株式會社

MORITO KABUSHIKI KAISHA (MORITO CO., LTD,)
2-4, Minami-hommachi,
4-chome, Chuo-ku,
Osaka-shi, Osaka, Japan

[74] MORITO SCOVILL HK CO LTD.

香港九龍

觀塘海濱道 143 號

中國航天科技中心 3 樓



[11] 2117500.5M001

[15] 28-01-2021

[30] 03-10-2020 / EU / 008194005-0001

[51] Cl. 3-01

[54] 袋

Bag

[73] GIVENCHY

3, avenue George V,
75008 Paris,
France

[74] WENPING PATENT & TRADE MARK AGENT LIMITED

1701 Tung Wai Commercial Building,
111 Gloucester Road,
Hong Kong



[11] 2117500.5M002

[15] 28-01-2021

[30] 03-10-2020 / EU / 008194005-0002

[51] Cl. 3-01

[54] 袋
Bag

[73] GIVENCHY
3, avenue George V,
75008 Paris,
France

[74] WENPING PATENT & TRADE MARK AGENT LIMITED
1701 Tung Wai Commercial Building,
111 Gloucester Road,
Hong Kong



[11] 2117500.5M003

- [15] 28-01-2021
[30] 03-10-2020 / EU / 008194005-0003
[51] Cl. 3-01
[54] 袋
Bag
[73] GIVENCHY
3, avenue George V,
75008 Paris,
France
[74] WENPING PATENT & TRADE MARK AGENT LIMITED
1701 Tung Wai Commercial Building,
111 Gloucester Road,
Hong Kong



-
- [11] 2117500.5M004
[15] 28-01-2021
[30] 03-10-2020 / EU / 008194005-0004
[51] Cl. 3-01
[54] 肩袋
Shoulder bag
[73] GIVENCHY
3, avenue George V,
75008 Paris,
France
[74] WENPING PATENT & TRADE MARK AGENT LIMITED
1701 Tung Wai Commercial Building,
111 Gloucester Road,
Hong Kong



[11] 2117500.5M005

[15] 28-01-2021

[30] 03-10-2020 / EU / 008194005-0005

[51] Cl. 3-01

[54] 袋
Bag

[73] GIVENCHY
3, avenue George V,
75008 Paris,
France

[74] WENPING PATENT & TRADE MARK AGENT LIMITED
1701 Tung Wai Commercial Building,
111 Gloucester Road,
Hong Kong



- [11] 2117501.7
[15] 28-01-2021
[51] Cl. 9-01
[54] 瓶
Bottle
[73] Suntory Holdings Limited
2-1-40 Dojimahama,
Kita-ku Osaka City, Osaka,
Japan
[74] MARKS & CLERK
Level 9, Cyberport 1,
100 Cyberport Road,
Pok Fu Lam, Hong Kong



-
- [11] 2117502.9M001
[15] 28-01-2021
[30] 07-08-2020 / JP / 016619 of 2020
[51] Cl. 21-02
[54] 鍛煉用器具
Training apparatus
[73] 株式會社 MTG
MTG Co., Ltd.
32, Honjin-Dori 2 Chome, Nakamura-Ku,
Nagoya-Shi, Aichi-Ken 453-0041,
Japan
[74] CHINAHONGKONG IP LIMITED
3011, 30/F, Office Tower, Convention Plaza,
1 Harbour Road,
Hong Kong



[11] 2117502.9M002

[15] 28-01-2021

[30] 07-08-2020 / JP / 016623 of 2020

[51] Cl. 21-02

[54] 鍛煉用器具

Training apparatus

[73] 株式會社 MTG

MTG Co., Ltd.

32, Honjin-Dori 2 Chome, Nakamura-Ku,

Nagoya-Shi, Aichi-Ken 453-0041,

Japan

[74] CHINAHONGKONG IP LIMITED

3011, 30/F, Office Tower, Convention Plaza,

1 Harbour Road,

Hong Kong

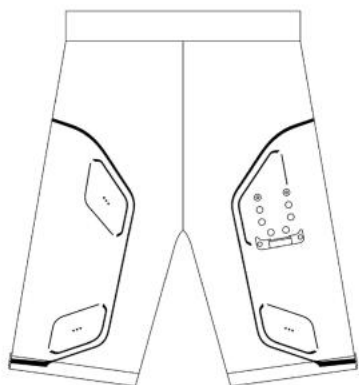



香港特別行政區政府知識產權署外觀設計註冊處

The Government of the Hong Kong Special Administrative Region

Designs Registry, Intellectual Property Department

根據註冊外觀設計條例第 28 條，下列註冊外觀設計因未繳續期費而停止有效。

各組記項按註冊外觀設計停止有效日期及註冊編號先後次序排列。

Registered designs ceased through non-payment of renewal fees under section 28 of the Registered Designs Ordinance. Entries are listed below under their expiry dates.

30-12-2019 - 30-12-2020

30-12-2019	29-12-2020	1502763.6M003
0902233.4M003	0503165.7	1502763.6M005
	0503170.7	1502763.6M006
24-12-2020	0503176.0M001	1502764.8
1502730.7	1002497.6	1502765.1
	1002498.8	1502766.3
27-12-2020	1002499.0M001	1502767.5
0011876.0	1002499.0M002	
1002473.5	1002503.1	
1002479.8	1002504.3M005	
1502736.0	1002504.3M006	
1502739.6M001	1002504.3M007	
1502739.6M002	1002504.3M008	
	1002508.2	
28-12-2020	1502746.1	
0503159.4M001	1502747.3	
0503159.4M002	1502749.7M001	
0503159.4M003	1502749.7M002	
0503159.4M004	1502750.9M001	
0503159.4M005	1502750.9M002	
1002488.7	1502751.1M001	
1002490.1	1502751.1M002	
1002491.3		
1002492.5	30-12-2020	
1002493.7	1002519.5M001	
1002494.9	1002519.5M002	
1002495.2	1002519.5M003	
1002496.4	1002519.5M004	
1502741.0M001	1502756.2	
1502741.0M002	1502757.4	
1502743.4M001	1502761.2	
1502743.4M002	1502762.4	
1502743.4M003	1502763.6M001	
	1502763.6M002	



香港特別行政區政府知識產權署外觀設計註冊處

The Government of the Hong Kong Special Administrative Region

Designs Registry, Intellectual Property Department

根據註冊外觀設計規則第 31 條刪除的註冊外觀設計。各組記項按註冊外觀設計刪除日期及註冊編號先後次序排列。

Registered designs removed under section 31 of the Registered Designs Rules. Entries are listed below under their removal dates.

26-02-2021 - 03-03-2021

26-02-2021	1501385.3
1001179.1	1501388.9M001
1001180.3M001	1501388.9M002
1001181.5	1501389.1M001
1001182.7	1501389.1M002
1001183.9	1501390.3M001
1501362.4	1501390.3M002
1501367.5M001	
1501367.5M002	
1501368.7	

03-03-2021

	0501569.2
	0501570.4M001
27-02-2021	0501570.4M002
1501373.7	0501570.4M003
1501374.9M001	0503022.4
1501374.9M002	0902233.4M003
1501374.9M003	1001195.5
1501374.9M004	1501394.1
1501374.9M005	1501396.6
1501374.9M006	1501397.8
1501374.9M007	1501398.0
1501375.2	1501399.2
1501376.4	1501400.6

28-02-2021

0501530.0	1501401.8
	1501402.0
	1501403.2
	1501404.4

01-03-2021

0501534.8M005	1501405.7
0501540.1M001	1501406.9
0501540.1M002	1501407.1
1001188.0M002	1501623.9M001
	1501623.9M002
	1501623.9M003

02-03-2021

0501552.6	1501623.9M004
-----------	---------------



香港特別行政區政府知識產權署外觀設計註冊處

The Government of the Hong Kong Special Administrative Region

Designs Registry, Intellectual Property Department

根據註冊外觀設計條例第 67 及 76 條，更正註冊紀錄冊內及已提交文件中的錯誤

Correction of Errors in Register and in Filed Documents under sections 67 and 76 of the Registered Designs Ordinance

任何人士現可對下列更正錯誤的請求提出反對

Request for correction of errors now open to opposition

如任何人士意欲反對下列請求，則須在本官方公報刊登是項更正請求的日期起計的兩個月內，根據註冊外觀設計規則第51(3)及62(4)條，採用指明外觀設計表格第D9號提交反對通知。如在限期內沒有收到任何反對通知，處長將依本公報刊登的更正請求的內容，准許是項更正請求。

If any person wishes to oppose the following request, he shall file a notice of opposition in specified Designs Form D9 within two months from the date of advertisement in this official journal under sections 51(3) and 62(4) of the Registered Designs Rules. If no notice of opposition is received, the request for correction will be allowed by the Registrar in the present advertised form.

[11] 2016284.2

[51] Cl. 11-04

[54] 花藝加濕器 Floral art humidifier