

香港知識產權公報

Hong Kong Intellectual Property Journal

2020年2月21日
21 February 2020



目錄 Contents

根據註冊外觀設計條例第 25 條註冊的外觀設計

Designs Registered under section 25 of the Registered Designs Ordinance

按註冊編號排列

Arranged by Registration Number

根據註冊外觀設計條例(第 522 章)公布的其他公告

Other Notices Published under the Registered Designs Ordinance (Cap. 522)

根據註冊外觀設計條例第 28 條, 註冊外觀設計因未繳續期費而停止有效

Registered designs ceased through non-payment of renewal fees under section 28 of the Registered Designs Ordinance

根據註冊外觀設計規則第 31 條刪除的註冊外觀設計

Registered designs removed under section 31 of the Registered Designs Rules

以下事項沒有記錄

No Records for the Following Matters

根據註冊外觀設計條例第 30 條放棄的外觀設計的註冊

Surrender of Registration of Design under section 30 of the Registered Designs Ordinance

根據註冊外觀設計規則第 37 條, 向處長作出轉介

Reference to Registrar under section 37 of the Registered Designs Rules

根據註冊外觀設計條例第 45 條, 撤銷註冊

Revocation of Registration under section 45 of the Registered Designs Ordinance

根據註冊外觀設計規則第 46 條，向法院作出轉介

Reference to Court under section 46 of the Registered Designs Rules

根據註冊外觀設計規則第 63 條對不符合規定之處作出糾正

Rectification of Irregularities under section 63 of the Registered Designs Rules

根據註冊外觀設計條例第 66 條，糾正註冊紀錄冊

Rectification of Register under section 66 of the Registered Designs Ordinance

根據註冊外觀設計條例第 67 條 更正註冊紀錄冊內的錯誤

Correction of errors in Register under section 67 of the Registered Designs Ordinance

根據註冊外觀設計條例第 67 及 76 條，更正註冊紀錄冊內及已提交文件中的錯誤

Correction of Errors in Register and in Filed Documents under sections 67 and 76 of the Registered Designs Ordinance

根據註冊外觀設計條例第 76 條，更正已提交文件中的錯誤

Correction of errors in filed documents under section 76 of the Registered Designs Ordinance

勘誤

Corrigendum

註冊外觀設計公告註釋

Notes on advertisements of registration of designs

方括號表示下列資料：

Square brackets indicate the following data：

[11] 註冊編號 Registration number / 聯合王國註冊編號 United Kingdom registration number

[15] 註冊日期 Registration date / 當作註冊日期 Deemed registration date / 聯合王國註冊日期 United Kingdom registration date

[17] 註冊有效期屆滿日期 Expiry date of the period of registration

[22] 提交日期 Filing date / 當作提交日期 Deemed filing date / 聯合王國提交日期 United Kingdom filing date

[30] 聲稱享有的優先權（提交日期 / 巴黎公約國或世界貿易組織成員 / 申請編號） Priority claimed (filing date / Paris Convention country or WTO member / application number)

[51] 國際外觀設計分類號（洛迦諾分類號） International Classification of designs (Locarno Classification)

[54] 物品 Article

[55] 外觀設計的表述 Representation of the design

[62] 分開前的申請編號及提交日期 Application number before division and filing date

[66] 過往註冊的聯繫外觀設計註冊編號 / 日期 Registration No. / Date of Previous Registration for Association

[72] 設計人 Designer

[73] 擁有人姓名和地址 Name and address of the owner

[74] 代理人 Agent / 送達地址 Address for service



香港特別行政區政府知識產權署外觀設計註冊處
The Government of the Hong Kong Special Administrative Region
Designs Registry, Intellectual Property Department

根據註冊外觀設計條例第 25 條註冊的外觀設計

Designs registered under section 25 of the Registered Designs Ordinance

按註冊編號排列

Arranged by Registration Number

[11] 1914113.6

[15] 03-07-2019

[51] Cl. 25-02

[54] 無框防火玻璃門

Frameless fire prevention glass door

[73] 保達方案有限公司

PYROTECH SOLUTIONS LIMITED

香港

九龍荔枝角青山道 485 號

九龍廣場 7 樓 702 室

[74] 天標知識產權代理有限公司

香港

九龍尖沙咀加連威老道 14 號

加連威大廈 4 樓 A 座



[11] 1914231.6M001

[15] 15-07-2019

[30] 16-01-2019 / FR / 2019-0216

[51] Cl. 3-01

[54] 袋

Bag

[73] LOUIS VUITTON MALLETIER

2 rue du Pont-Neuf

75001 Paris

FRANCE

[74] BAKER & MCKENZIE

14TH FLOOR, ONE TAIKOO PLACE,

979 KING'S ROAD, QUARRY BAY,

HONG KONG



[11] 1914231.6M002

[15] 15-07-2019

[30] 16-01-2019 / FR / 2019-0216

[51] Cl. 3-01

[54] 袋

Bag

[73] LOUIS VUITTON MALLETIER

2 rue du Pont-Neuf

75001 Paris

FRANCE

[74] BAKER & MCKENZIE

14TH FLOOR, ONE TAIKOO PLACE,

979 KING'S ROAD, QUARRY BAY,

HONG KONG



[11] 1914422.1

[15] 09-08-2019

[30] 13-02-2019 / DE / 402019100184.0

[51] Cl. 21-01

[54] 玩具汽車

Toy vehicle

[73] VOLKSWAGEN AKTIENGESELLSCHAFT

38436 WOLFSBURG

GERMANY

[74] CHINA PATENT AGENT (HONG KONG) LIMITED

22/F, Great Eagle Centre, 23 Harbour Road, Wanchai

HONG KONG



[11] 1914425.8M001

[15] 09-08-2019

[30] 13-02-2019 / DE / 40 2019 100 184.0

[51] Cl. 12-08

[54] 汽車

Motor vehicle

[73] VOLKSWAGEN AKTIENGESELLSCHAFT

38436 WOLFSBURG

GERMANY

[74] CHINA PATENT AGENT (HONG KONG) LIMITED

22/F, Great Eagle Centre, 23 Harbour Road, Wanchai

HONG KONG



[11] 1914425.8M002

[15] 09-08-2019

[30] 13-02-2019 / DE / 40 2019 100 184.0

[51] Cl. 12-08

[54] 汽車

Motor vehicle

[73] VOLKSWAGEN AKTIENGESELLSCHAFT

38436 WOLFSBURG

GERMANY

[74] CHINA PATENT AGENT (HONG KONG) LIMITED

22/F, Great Eagle Centre, 23 Harbour Road, Wanchai

HONG KONG



[11] 1914425.8M003

[15] 09-08-2019

[30] 13-02-2019 / DE / 40 2019 100 184.0

[51] Cl. 12-08

[54] 汽車

Motor vehicle

[73] VOLKSWAGEN AKTIENGESELLSCHAFT

38436 WOLFSBURG

GERMANY

[74] CHINA PATENT AGENT (HONG KONG) LIMITED

22/F, Great Eagle Centre, 23 Harbour Road, Wanchai

HONG KONG



[11] 1914439.7M001

[15] 12-08-2019

[30] 13-02-2019 / DE / 40 2019 100 185.9

[51] Cl. 12-08

[54] 汽車

Motor vehicle

[73] VOLKSWAGEN AKTIENGESELLSCHAFT

38436 WOLFSBURG

GERMANY

[74] CHINA PATENT AGENT (HONG KONG) LIMITED

22/F, Great Eagle Centre, 23 Harbour Road, Wanchai

HONG KONG



[11] 1914439.7M002

[15] 12-08-2019

[30] 13-02-2019 / DE / 40 2019 100 185.9

[51] Cl. 12-08

[54] 汽車

Motor vehicle

[73] VOLKSWAGEN AKTIENGESELLSCHAFT

38436 WOLFSBURG

GERMANY

[74] CHINA PATENT AGENT (HONG KONG) LIMITED

22/F, Great Eagle Centre, 23 Harbour Road, Wanchai

HONG KONG



[11] 1914439.7M003

[15] 12-08-2019

[30] 13-02-2019 / DE / 40 2019 100 185.9

[51] Cl. 12-08

[54] 汽車

Motor vehicle

[73] VOLKSWAGEN AKTIENGESELLSCHAFT

38436 WOLFSBURG

GERMANY

[74] CHINA PATENT AGENT (HONG KONG) LIMITED

22/F, Great Eagle Centre, 23 Harbour Road, Wanchai

HONG KONG



[11] 1914445.0M001

[15] 12-08-2019

[30] 11-02-2019 / US / 29/679,881

[51] Cl. 9-01

[54] 分配器

Dispenser

[73] 麥思德產品公共利益公司

METHOD PRODUCTS, PBC

637 COMMERCIAL STREET, SUITE 300, SAN FRANCISCO, CA 94111

UNITED STATES

[74] CLT PATENT & TRADEMARK (H.K.) LIMITED

Unit 09, 34/F., Office Tower, Convention Plaza

No. 1 Harbour Road, Wanchai

HONG KONG

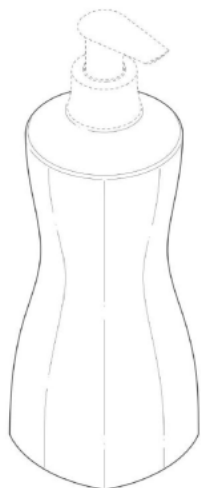

[11] 1914445.0M002

[15] 12-08-2019

[30] 11-02-2019 / US / 29/679,883

[51] Cl. 9-01

[54] 分配器

DISPENSER

[73] 麥思德產品公共利益公司

METHOD PRODUCTS, PBC

637 COMMERCIAL STREET, SUITE 300, SAN FRANCISCO, CA 94111

UNITED STATES

[74] CLT PATENT & TRADEMARK (H.K.) LIMITED

Unit 09, 34/F., Office Tower, Convention Plaza

No. 1 Harbour Road, Wanchai

HONG KONG

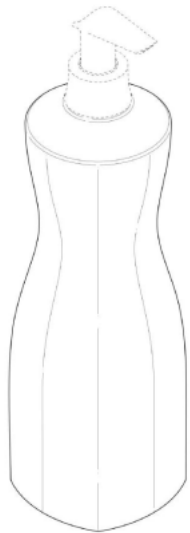

[11] 1914450.0

[15] 12-08-2019

[51] Cl. 3-01

[54] 手機保護套

Mobile phone case

[73] INNOVHK LIMITED

香港

新界沙田安耀街 3 號

匯達大廈 9 樓 911-915 室

[74] 天標知識產權代理有限公司

香港

九龍尖沙咀加連威老道 14 號

加連威大廈 4 樓 A 座



[11] 1914583.2

[15] 02-09-2019

[51] Cl. 15-99

[54] 氣動封口機
Air-Sealer

[73] Best Precision Machinery (International) Co., Limited

貝斯迪精工機械(國際)有限公司

香港

九龍尖東麼地道 63 號

好時中心 2 樓 279 室

[74] BKIP Limited

香港

灣仔告士打道 169 號

1 樓

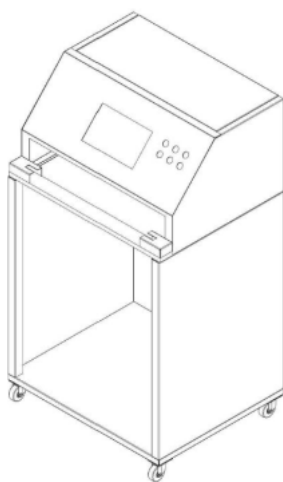

[11] 1914596.0

[15] 04-09-2019

[51] Cl. 11-01

[54] 戒子
Ring

[73] 周生生珠寶金行有限公司

Chow Sang Sang Jewellery Company Limited

4/F., Chow Sang Sang Building,

229 Nathan Road, Kowloon,

HONG KONG

[74] HONG KONG INTELLECTUAL PROPERTY AGENT LIMITED

Unit 230, 2/F, Building 12W, No. 12 Science Park West Avenue,

Phase 3, Hong Kong Science Park, Pak Shek Kok, N.T.,

HONG KONG



[11] 1914600.0

[15] 04-09-2019

[30] 15-03-2019 / MA, RS, SG, CH, TR, UA, US, EU, KR / WIPO81524

[51] Cl. 11-01

[54] 珠寶元素

Element of jewellery

[73] CHOPARD INTERNATIONAL SA

Route de Promenthoux

1197 Prangins

SWITZERLAND

[74] WILKINSON & GRIST

6th Floor, Prince's Building

Chater Road

HONG KONG



[11] 1914610.1

[15] 04-09-2019

[30] 04-03-2019 / FR / 2019-1095

[51] Cl. 3-01

[54] 袋
Bag

[73] LOUIS VUITTON MALLETIER
2, rue du Pont-Neuf 75001 Paris,
FRANCE

[74] BAKER & MCKENZIE
14TH FLOOR, ONE TAIKOO PLACE,
979 KING'S ROAD, QUARRY BAY,
HONG KONG



[11] 1914636.6

[15] 09-09-2019

[30] 02-05-2019 / EM / 006408662-0002

[51] Cl. 23-04

[54] 加濕器
A humidifier

[73] Dyson Technology Limited
Tetbury Hill, Malmesbury, Wiltshire, SN16 0RP
UNITED KINGDOM

[74] LIU, SHEN & ASSOCIATES
Room 3716, 37/F, Sun Hung Kai Centre,
30 Harbour Road, Wanchai,
HONG KONG

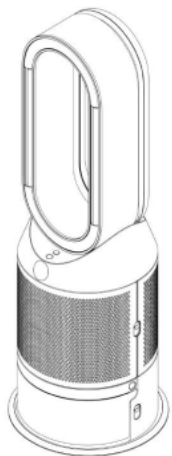

[11] 1914638.0

[15] 10-09-2019

[51] Cl. 13-02

[54] 轉接器充電底座
Adapter charging base

[73] Shenzhen Targetever Technology Co.,Ltd
深圳市金拓達科技有限公司
中國內地
深圳市龍華新區龍華辦事處龍苑大道
聯華工業區 B 棟廠房 6.11 層

[74] 港智國際知識產權代理有限公司
香港
屯門震寰路 3 號
德榮工業大廈 20 字樓 B6 室



- [11] 1914640.4
[15] 11-09-2019
[51] Cl. 21-01
[54] 模型車
Model vehicle
[73] KABUSHIKI KAISHA TAMIYA (TAMIYA, INC.)
3-7, Ondawara,
Shizuoka-City, 422-8610,
JAPAN
[74] CHAN, TANG & KWOK
Rooms 2503-04, 25/F., Shanghai Industrial Investment Building,
48-62 Hennessy Road, Wanchai,
HONG KONG

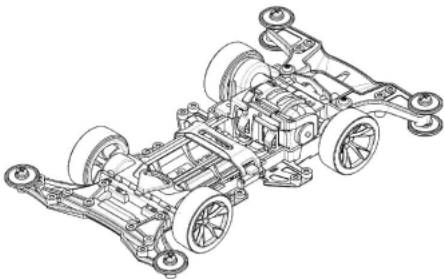

-
- [11] 1914642.8M001
[15] 11-09-2019
[30] 18-03-2019 / AM, AZ, BZ, BA, GE, LI, MK, MD, MN, ME, OM, RU,
SG, CH, TN, TR, GB, EU, AL, KG / DM/200 977
[51] Cl. 10-02
[54] 錶
Watch
[73] Glashütter Uhrenbetrieb GMBH
Altenberger Str. 1, 01768 Glashütte,
GERMANY
[74] SPRUSON & FERGUSON (HONG KONG) LIMITED
5001 Hopewell Centre
183 Queen's Road East, Wan Chai
HONG KONG



[11] 1914642.8M002

[15] 11-09-2019

[30] 18-03-2019 / AM, AZ, BZ, BA, GE, LI, MK, MD, MN, ME, OM, RU,
SG, CH, TN, TR, GB, EU, AL, KG / DM/200 977

[51] Cl. 10-02

[54] 錶

Watch

[73] Glashütter Uhrenbetrieb GMBH
Altenberger Str. 1, 01768 Glashütte,
GERMANY

[74] SPRUSON & FERGUSON (HONG KONG) LIMITED
5001 Hopewell Centre
183 Queen's Road East, Wan Chai
HONG KONG



[11] 1914642.8M003

[15] 11-09-2019

[30] 18-03-2019 / AM, AZ, BZ, BA, GE, LI, MK, MD, MN, ME, OM, RU,
SG, CH, TN, TR, GB, EU, AL, KG / DM/200 977

[51] Cl. 10-07

[54] 錶殼

Watch Case

[73] Glashütter Uhrenbetrieb GMBH
Altenberger Str. 1, 01768 Glashütte,
GERMANY

[74] SPRUSON & FERGUSON (HONG KONG) LIMITED
5001 Hopewell Centre
183 Queen's Road East, Wan Chai
HONG KONG



[11] 1914642.8M004

[15] 11-09-2019

[30] 18-03-2019 / AM, AZ, BZ, BA, GE, LI, MK, MD, MN, ME, OM, RU,
SG, CH, TN, TR, GB, EU, AL, KG / DM/200 977

[51] Cl. 10-07

[54] 錶面
Dial

[73] Glashütter Uhrenbetrieb GMBH
Altenberger Str. 1, 01768 Glashütte,
GERMANY

[74] SPRUSON & FERGUSON (HONG KONG) LIMITED
5001 Hopewell Centre
183 Queen's Road East, Wan Chai
HONG KONG



- [11] 1914644.2
[15] 12-09-2019
[30] 15-03-2019 / CH / DM/200 836
[51] Cl. 10-07
[54] 具有錶盤的錶殼
Watch case with dial
[73] LVMH SWISS MANUFACTURES SA
Rue Louis-Joseph Chevrolet 6A
2300 La Chaux-de-Fonds
SWITZERLAND
[74] WENPING & CO
1701 Tung Wai Commercial Building,
111 Gloucester Road,
HONG KONG



-
- [11] 1914646.7M001
[15] 12-09-2019
[30] 07-05-2019 / WO / DM/200 983
[51] Cl. 10-07
[54] 鐘錶元件
Timepiece component
[73] NIVAROX-FAR S.A.
avenue du Collège 10, CH-2400 LE LOCLE,
SWITZERLAND
[74] SPRUSON & FERGUSON (HONG KONG) LIMITED
5001 Hopewell Centre
183 Queen's Road East, Wan Chai
HONG KONG

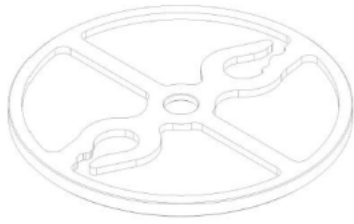

[11] 1914646.7M002

[15] 12-09-2019

[30] 07-05-2019 / WO / DM/200 983

[51] Cl. 10-07

[54] 鐘錶元件

Timepiece component

[73] NIVAROX-FAR S.A.

avenue du Collège 10, CH-2400 LE LOCLE,
SWITZERLAND

[74] SPRUSON & FERGUSON (HONG KONG) LIMITED

5001 Hopewell Centre
183 Queen's Road East, Wan Chai
HONG KONG

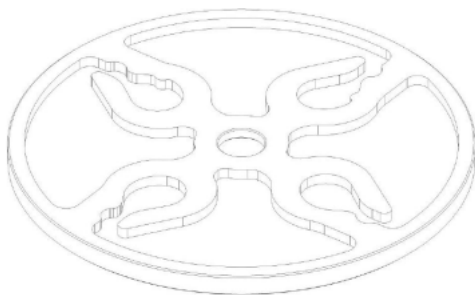

[11] 1914648.1

[15] 12-09-2019

[51] Cl. 7-02

[54] 烹調器具

Cooking device

[73] 陳猷楨

Hsien-Chen CHEN

18F.-2, No. 21, Ln. 35, Sec. 2
Sanmin Rd., Banqiao Dist., New Taipei City
TAIWAN

[74] WENPING & CO
1701 Tung Wai Commercial Building,
111 Gloucester Road,
HONG KONG

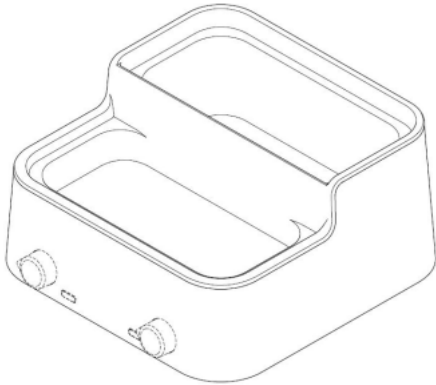

[11] 1914652.9M001
[15] 12-09-2019
[30] 18-03-2019 / SG, CH, TR, EU / DM/201825
[51] Cl. 10-02
[54] 手錶
Wristwatch
[73] Hublot SA, Genève
Rue du Rhône 30
1204 Geneva
SWITZERLAND
[74] ATL LAW OFFICES
16/F., China Hong Kong Tower,
8-12 Hennessy Road, Wanchai,
HONG KONG



- [11] 1914652.9M002
[15] 12-09-2019
[30] 18-03-2019 / SG, CH, TR, EU / DM/201825
[51] Cl. 10-02
[54] 手錶
Wristwatch
[73] Hublot SA, Genève
Rue du Rhône 30
1204 Geneva
SWITZERLAND
[74] ATL LAW OFFICES
16/F., China Hong Kong Tower,
8-12 Hennessy Road, Wanchai,
HONG KONG



-
- [11] 1914652.9M003
[15] 12-09-2019
[30] 18-03-2019 / SG, CH, TR, EU / DM/201825
[51] Cl. 10-02
[54] 錶
Watch
[73] Hublot SA, Genève
Rue du Rhône 30
1204 Geneva
SWITZERLAND
[74] ATL LAW OFFICES
16/F., China Hong Kong Tower,
8-12 Hennessy Road, Wanchai,
HONG KONG



[11] 1914652.9M004

[15] 12-09-2019

[30] 18-03-2019 / SG, CH, TR, EU / DM/201825

[51] Cl. 10-02

[54] 錶

Watch

[73] Hublot SA, Genève

Rue du Rhône 30

1204 Geneva

SWITZERLAND

[74] ATL LAW OFFICES

16/F., China Hong Kong Tower,

8-12 Hennessy Road, Wanchai,

HONG KONG

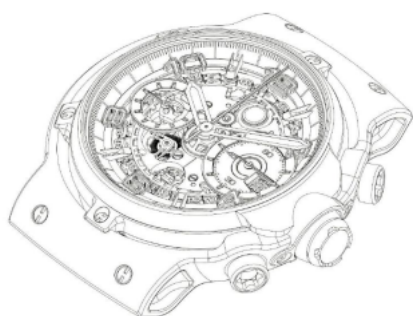

[11] 1914652.9M005

[15] 12-09-2019

[30] 18-03-2019 / SG, CH, TR, EU / DM/201825

[51] Cl. 10-07

[54] 錶殼
Watch case

[73] Hublot SA, Genève
Rue du Rhône 30
1204 Geneva
SWITZERLAND

[74] ATL LAW OFFICES
16/F., China Hong Kong Tower,
8-12 Hennessy Road, Wanchai,
HONG KONG

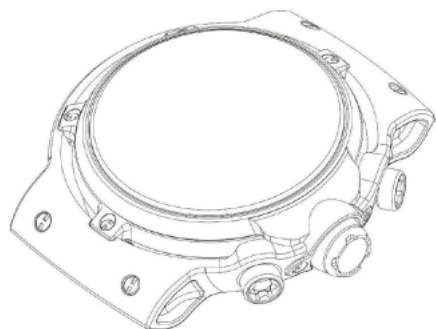

[11] 1914654.3

[15] 13-09-2019

[30] 15-03-2019 / EU / 006308821

[51] Cl. 21-01

[54] 玩具汽車
Toy Car

[73] FERRARI S.p.A.
VIA EMILIA EST 1163
I-41100 MODENA
ITALY

[74] CHINA PATENT AGENT (HONG KONG) LIMITED
22/F, Great Eagle Centre, 23 Harbour Road, Wanchai
HONG KONG

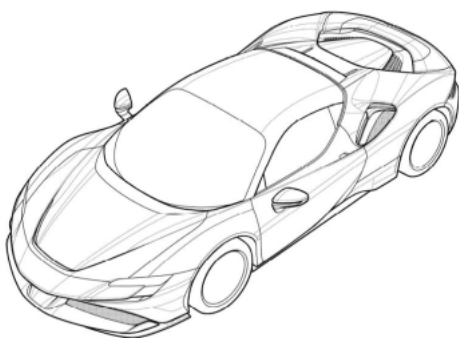

- [11] 1914660.6
[15] 16-09-2019
[51] Cl. 16-01
[54] 文件攝像機
Document camera
[73] ProVision Digital International Ltd.
普光數碼國際有限公司
香港
新界荃灣青山公路 491-501 號
嘉力工業中心 B 座 7 樓 707 室
[74] 卓遠知識產權有限公司
香港
上環禧利街 27 號
富輝商業中心 10 樓

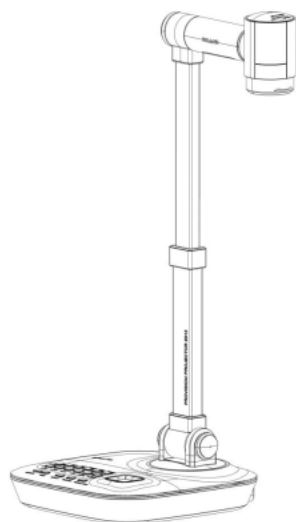

-
- [11] 1914662.0
[15] 16-09-2019
[30] 21-08-2019 / EM / 006747754
[51] Cl. 9-09
[54] 垃圾箱
Bin
[73] Brabantia Nederland B.V.
De Haak 14,
5555 XK Valkenswaard,
NETHERLANDS
[74] NTD PATENT & TRADE MARK AGENCY LIMITED
Units 1805-6, 18/F., Greenfield Tower, Concordia Plaza,

No. 1 Science Museum Road, Tsimshatsui East, Kowloon,
HONG KONG



[11] 1914664.4

[15] 17-09-2019

[30] 09-07-2019 / CH / 144765

[51] Cl. 10-02

[54] 手錶

Wristwatch

[73] Juvenia Montres S.A.

Rue du Châtelot 21

2300 La Chaux-de-Fonds

SWITZERLAND

[74] ATL LAW OFFICES

16/F., China Hong Kong Tower,

8-12 Hennessy Road, Wanchai,

HONG KONG



- [11] 1914666.9
[15] 17-09-2019
[30] 18-03-2019 / CN / 201930110368.7
[51] Cl. 15-05
[54] 波輪洗衣機
Pulsator washing machine
[73] 北京小米移動軟件有限公司
Beijing Xiaomi Mobile Software Co., Ltd.
中國內地
北京市海澱區清河中街 68 號
華潤五彩城購物中心二期 9 層 01 房間
[74] 隆天專利商標代理有限公司
香港
九龍青山道 485 號
九龍廣場 10 樓 11 室



-
- [11] 1914676.0
[15] 18-09-2019
[30] 12-05-2019 / EM / 006444576-0001
[51] Cl. 9-01
[54] 香水產品瓶
Flask for perfumery products
[73] PARFUMS CHRISTIAN DIOR
33 Avenue Hoche
75008 Paris
FRANCE
[74] WENPING & CO
1701 Tung Wai Commercial Building,
111 Gloucester Road,
HONG KONG



[11] 1914678.4

[15] 18-09-2019

[51] Cl. 25-02

[54] 扶手

Handrail

[73] Kansatsu no Ki Ltd.

5F., No.13, Ln. 28, Renxing St., Sanchong Dist., New Taipei
City 241

TAIWAN

Kansatsu no Ki Ltd

4F AOI Bldg, 5-18-12 Mita, Minato-Ku, Tokyo, 108-0073

JAPAN

WU, Yi-Fang

5F., No.13, Ln. 28, Renxing St., Sanchong Dist., New Taipei
City 241

TAIWAN

[74] LECTO IP LIMITED

Suite 2207-9, Tower Two, Lippo Centre

89 Queensway, Admiralty

HONG KONG

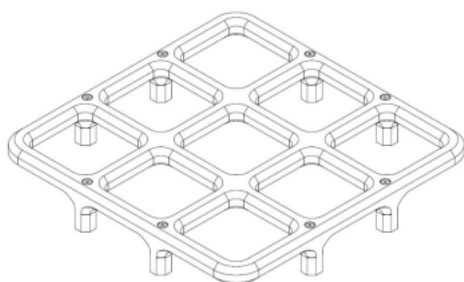

- [11] 1914952.5
[15] 06-11-2019
[30] 06-05-2019 / EU / 006428710
[51] Cl. 5-05
[54] 用於紡織品的裝飾品
Ornament, in particular for textile products
[73] Loro Piana S.p.A.
Corso Rolandi, 10
I-13017 Quarona (Vercelli)
ITALY
[74] WILKINSON & GRIST
6th Floor, Prince's Building
Chater Road
HONG KONG

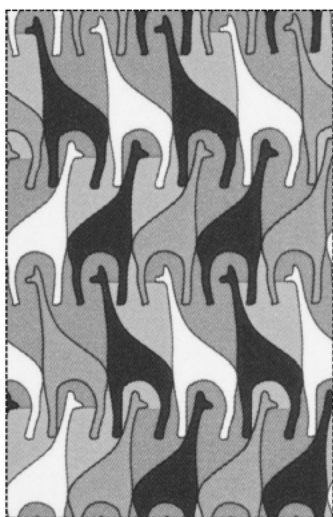

-
- [11] 1914980.4
[15] 07-11-2019
[30] 07-05-2019 / FR / 2019-2147
[51] Cl. 2-07
[54] 拉鍊
Slide fastener
[73] LOUIS VUITTON MALLETIER
2, rue du Pont-Neuf 75001 Paris,
FRANCE
[74] BAKER & MCKENZIE
14TH FLOOR, ONE TAIKOO PLACE,
979 KING'S ROAD, QUARRY BAY,
HONG KONG





香港特別行政區政府知識產權署外觀設計註冊處

The Government of the Hong Kong Special Administrative Region

Designs Registry, Intellectual Property Department

根據註冊外觀設計條例第 28 條，下列註冊外觀設計因未繳續期費而停止有效。

各組記項按註冊外觀設計停止有效日期及註冊編號先後次序排列。

Registered designs ceased through non-payment of renewal fees under section 28 of the Registered Designs Ordinance. Entries are listed below under their expiry dates.

24-01-2020 - 29-01-2020

24-01-2020	1500225.4M003	1500253.2
0500169.2M003	1500226.6M001	1500254.4M001
	1500226.6M002	1500254.4M002
25-01-2020		1500254.4M003
0010126.9	28-01-2020	1500254.4M004
1000154.7	1000177.6	1500254.4M006
1500199.7	1000178.8	1500254.4M007
1500201.3	1000180.2M001	1500254.4M011
1500202.5	1500231.6	1500254.4M012
	1500237.9M001	1500256.9
26-01-2020	1500237.9M002	1500258.3
1000158.6	1500237.9M003	1500260.7
1000159.8	1500237.9M004	1500261.9
1000160.0	1500237.9M005	1500262.1
1500207.6	1500237.9M006	1500263.3
1500208.8	1500238.1M001	1500264.5
	1500238.1M002	1500265.8
27-01-2020	1500239.3	1500266.0
0500188.2M004	1500240.5	1500267.2
0500188.2M005	1500241.7	1500268.4
0500188.2M006	1500242.9	1500282.3
0500188.2M007	1500243.1	
0500189.4	1500244.3	
1000167.5		
1000168.7	29-01-2020	
1000172.5	1500247.0M001	
1000173.7	1500247.0M002	
1500210.2	1500247.0M003	
1500211.4	1500247.0M004	
1500220.3	1500247.0M005	
1500221.5	1500247.0M006	
1500222.7	1500251.8M001	
1500225.4M001	1500251.8M002	
1500225.4M002	1500252.0	



香港特別行政區政府知識產權署外觀設計註冊處

The Government of the Hong Kong Special Administrative Region

Designs Registry, Intellectual Property Department

根據註冊外觀設計規則第 31 條刪除的註冊外觀設計。各組記項按註冊外觀設計刪除日期及註冊編號先後次序排列。

Registered designs removed under section 31 of the Registered Designs Rules. Entries are listed below under their removal dates.

31-01-2020 - 06-02-2020

31-01-2020	1401401.7
0411626.5	9910953.0
1401371.2	9910954.2
1401372.4M001	9910955.5
1401372.4M002	9910956.7
1401376.3	

05-02-2020

01-02-2020	0411681.0M008
1401387.6	0411681.0M009
1401388.8	0901194.9M002
1401389.0	1401403.1
1401390.2	1401406.8
1401391.4	
1401392.6	
1401393.8	

06-02-2020

	0411696.2
	0411698.6
02-02-2020	0411699.8
0411631.5M002	0901198.8
0411631.5M003	1401413.2

03-02-2020

0411640.4
0901181.2
0901183.6M001
0901183.6M002
9910941.5M001
9910941.5M003
9910945.4
9910947.8

04-02-2020

0411667.1M001
1401367.4
1401400.5