

香港知識產權公報

Hong Kong Intellectual Property Journal

2019 年 6 月 21 日

21 June 2019

目錄

Contents

根據註冊外觀設計條例第 25 條註冊的外觀設計

Designs Registered under section 25 of the Registered Designs Ordinance

按註冊編號排列

Arranged by Registration Number

根據註冊外觀設計條例(第 522 章)公布的其他公告

Other Notices Published under the Registered Designs Ordinance (Cap. 522)

根據註冊外觀設計條例第 28 條，註冊外觀設計因未繳續期費而停止有效

Registered designs ceased through non-payment of renewal fees under section 28 of the Registered Designs Ordinance

根據註冊外觀設計規則第 31 條刪除的註冊外觀設計

Registered designs removed under section 31 of the Registered Designs Rules

以下事項沒有記錄

No Records for the Following Matters

根據註冊外觀設計條例第 30 條放棄的外觀設計的註冊

Surrender of Registration of Design under section 30 of the Registered Designs Ordinance

根據註冊外觀設計規則第 37 條，向處長作出轉介

Reference to Registrar under section 37 of the Registered Designs Rules

根據註冊外觀設計條例第 45 條，撤銷註冊

Revocation of Registration under section 45 of the Registered Designs Ordinance

根據註冊外觀設計規則第 46 條，向法院作出轉介
Reference to Court under section 46 of the Registered Designs Rules

根據註冊外觀設計規則第 63 條對不符合規定之處作出糾正
Rectification of Irregularities under section 63 of the Registered Designs Rules

根據註冊外觀設計條例第 66 條，糾正註冊紀錄冊
Rectification of Register under section 66 of the Registered Designs Ordinance

根據註冊外觀設計條例第 67 條，更正註冊紀錄冊內的錯誤
Correction of Errors in Register under section 67 of the Registered Designs Ordinance

根據註冊外觀設計條例第 67 及 76 條，更正註冊紀錄冊內及已提交文件中的錯誤
Correction of Errors in Register and in Filed Documents under sections
67 and 76 of the Registered Designs Ordinance

根據註冊外觀設計條例第 76 條，更正已提交文件中的錯誤
Correction of Errors in Filed Documents under section 76 of the Registered Designs
Ordinance

勘誤
Corrigendum

註冊外觀設計公告註釋

Notes on advertisements of registration of designs

方括號表示下列資料：

Square brackets indicate the following data：

[11] 註冊編號 Registration number / 聯合王國註冊編號 United Kingdom registration number

[15] 註冊日期 Registration date / 當作註冊日期 Deemed registration date / 聯合王國註冊日期 United Kingdom registration date

[17] 註冊有效期屆滿日期 Expiry date of the period of registration

[22] 提交日期 Filing date / 當作提交日期 Deemed filing date / 聯合王國提交日期 United Kingdom filing date

[30] 聲稱享有的優先權 (提交日期 / 巴黎公約國或世界貿易組織成員 / 申請編號) Priority claimed (filing date / Paris Convention country or WTO member / application number)

[51] 國際外觀設計分類號 (洛迦諾分類號) International Classification of designs (Locarno Classification)

[54] 物品 Article

[55] 外觀設計的表述 Representation of the design

[62] 分開前的申請編號及提交日期 Application number before division and filing date

[66] 過往註冊的聯繫外觀設計註冊編號 / 日期 Registration No. / Date of Previous Registration for Association

[72] 設計人 Designer

[73] 擁有人姓名和地址 Name and address of the owner

[74] 代理人 Agent / 送達地址 Address for service



香港特別行政區政府知識產權署外觀設計註冊處

The Government of the Hong Kong Special Administrative Region

Designs Registry, Intellectual Property Department

根據註冊外觀設計條例第 25 條註冊的外觀設計

Designs registered under section 25 of the Registered Designs Ordinance

按註冊編號排列

Arranged by Registration Number

[11] 1801375.5

[15] 06-07-2018

[51] Cl. 14-02

[54] 物聯網控制器

Controller for internet of things

[73] Megasoft Limited

Unit 301-302, 3/F, Building 12W,

No. 12 Science Park West Avenue,

Hong Kong Science Park, Shatin, New Territories, Hong Kong

[74] Barron & Young Intellectual Property Limited

Suite 617, Lakeside 2,

No. 10 Science Park West Avenue,

Hong Kong Science Park, N.T., Hong Kong.



[11] 1802006.5

[15] 21-05-2018

[51] Cl. 25-01

[54] 金屬盲導標示

Metal tactile marker

- [73] Candace Guidance Signage Limited
Room 2802, Kwai Hung Holdings Centre,
89 King's Road, North Point, Hong Kong
- [74] Candace Guidance Signage Limited
Room 2802, Kwai Hung Holdings Centre,
89 King's Road, North Point, HK



-
- [11] 1802178.8
- [15] 05-11-2018
- [51] Cl. 15-99
- [54] 雨傘包裹機
Umbrella wrapping machine
- [73] 擎天經貿國際有限公司
Giannia Group LV Limited
607 Yen Sheng Centre,
64 Hoi Yuen Road, Kwun Tong,
Kowloon, Hong Kong
- [74] HONG KONG INTELLECTUAL PROPERTY AGENT LIMITED
Unit 230, 2/F, Building 12W,
No.12 Science Park West Avenue,
Phase 3, Hong Kong Science Park, Pak Shek Kok, N.T., Hong
Kong.



[11] 1802183.8

[15] 06-11-2018

[51] Cl. 6-13

[54] 墊布

Placemat

[73] Chilewich Sultan LLC

39 West 19th Street, 11th Floor,
New York New York 10011,
UNITED STATES

[74] Robin Bridge & John Liu

6th Floor, Emperor Commercial Centre,
39 Des Voeux Road Central,
Hong Kong.



[11] 1802234.7M001

[15] 15-11-2018

[51] Cl. 21-01

[54] 玩具人

Toy figure

[73] YAU CHI SUNG

FLAT C, 19/F., BLOCK 2,

METRO TOWN, TSEUNG KWAN O,
N.T., HONG KONG

[74] YAU CHI SUNG
Flat C, 19/F., Block 2,
Metro Town, Tseung Kwan O,
N.T., Hong Kong



[11] 1802234.7M002

[15] 15-11-2018

[51] Cl. 21-01

[54] 玩具人

Toy figure

[73] YAU CHI SUNG

FLAT C, 19/F., BLOCK 2, METRO TOWN, TSEUNG KWAN O, N.T., HONG KONG

[74] YAU CHI SUNG

Flat C, 19/F., Block 2, Metro Town, Tseung Kwan O, N.T., Hong Kong



- [11] 1802293.1
- [15] 23-11-2018
- [30] 28-05-2018 / CN / 201830256430.9
- [51] Cl. 14-04
- [54] 用於手機的圖形用戶界面
Graphical user interface for mobile phones
- [73] 北京京東尚科信息技術有限公司
BEIJING JINGDONG SHANGKE INFORMATION TECHNOLOGY CO., LTD.
中國內地 北京市
海淀區 知春路 76
號 8 層
- 北京京東世紀貿易有限公司
BEIJING JINGDONG CENTURY TRADING CO., LTD.
中國內地 北京市
大興區
北京經濟技術開發區科創十一街 18 號 C 座 2 層 201 室
- [74] 隆天專利商標代理有限公司
香港九龍
青山道 485 號
九龍廣場 10 樓 11 室



-
- [11] 1802307.3
- [15] 26-11-2018
- [30] 25-05-2018 / CN / 201830252776.1
- [51] Cl. 14-04
- [54] 用於電腦的圖形用戶界面
Graphical user interface for computer

[73] 北京京東世紀貿易有限公司
BEIJING JINGDONG CENTURY TRADING CO., LTD.
中國內地 北京市
大興區
北京經濟技術開發區科創十一街 18 號 C 座 2 層 201 室

北京京東尚科信息技術有限公司
BEIJING JINGDONG SHANGKE INFORMATION TECHNOLOGY CO., LTD.
中國內地 北京市
海淀區 知春路 76
號 8 層

[74] 隆天專利商標代理有限公司
香港九龍
青山道 485 號
九龍廣場 10 樓 11 室



[11] 1802391.9

[15] 05-12-2018

[30] 05-06-2018 / US / 29/650,218

[51] Cl. 14-01

[54] 360 度會議麥克風
360 Degree conference microphone

[73] 馬歇爾電子有限公司
MARSHALL ELECTRONICS, INC.
20608 Madrona Avenue, Torrance,
CA 90503, United States

[74] JEAC I.P. AGENT COMPANY
Rm. 1522 Nan Fung Centre,
264-298 Castle Peak Road, Tsuen Wan,
N.T., Hong Kong.

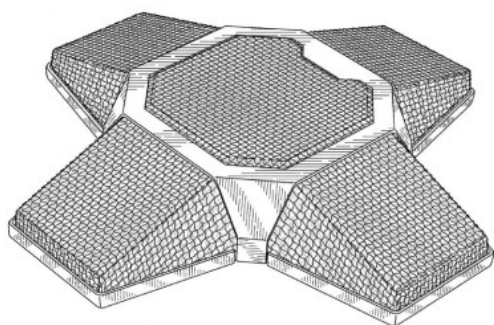

[11] 1802438.0M001

[15] 11-12-2018

[30] 16-11-2018 / EM, AZ, MC, AL, AM, BZ, GE, BA, LI, MN, ME, MA,
NO, OM, MD, SG, CH, TN, UA, GB, TR, KG, MK / 77127

[51] Cl. 11-01

[54] 耳環
Earring

[73] Harry Winston SA
Chemin du Tourbillon 8,
CH-1228 Plan-les-Ouates,
SWITZERLAND

[74] Spruson & Ferguson (Hong Kong) Limited
5001 Hopewell Centre,
183 Queen's Road East,
Hong Kong.



[11] 1802438.0M002

[15] 11-12-2018

[30] 16-11-2018 / EM, AZ, MC, AL, AM, BZ, GE, BA, LI, MN, ME, MA,
NO, OM, MD, SG, CH, TN, UA, GB, TR, KG, MK / 77127

[51] Cl. 11-01

[54] 項鍊

Necklace

[73] Harry Winston SA

Chemin du Tourbillon 8,
CH-1228 Plan-les-Ouates,
SWITZERLAND

[74] Spruson & Ferguson (Hong Kong) Limited

5001 Hopewell Centre,
183 Queen's Road East,
Hong Kong.



[11] 1802438.0M003

[15] 11-12-2018

[30] 16-11-2018 / EM, AZ, MC, AL, AM, BZ, GE, BA, LI, MN, ME, MA,
NO, OM, MD, SG, CH, TN, UA, GB, TR, KG, MK / 77127

[51] Cl. 11-01

[54] 項鍊

Necklace

[73] Harry Winston SA

Chemin du Tourbillon 8,
CH-1228 Plan-les-Ouates,
SWITZERLAND

[74] Spruson & Ferguson (Hong Kong) Limited

5001 Hopewell Centre,
183 Queen's Road East,
Hong Kong.



[11] 1802438.0M004

[15] 11-12-2018

[30] 16-11-2018 / EM, AZ, MC, AL, AM, BZ, GE, BA, LI, MN, ME, MA,
NO, OM, MD, SG, CH, TN, UA, GB, TR, KG, MK / 77127

[51] Cl. 11-01

[54] 耳環
Earring

[73] Harry Winston SA
Chemin du Tourbillon 8,
CH-1228 Plan-les-Ouates,
SWITZERLAND

[74] Spruson & Ferguson (Hong Kong) Limited
5001 Hopewell Centre,
183 Queen's Road East,
Hong Kong.



[11] 1802438.0M005

[15] 11-12-2018

[30] 16-11-2018 / EM, AZ, MC, AL, AM, BZ, GE, BA, LI, MN, ME, MA,
NO, OM, MD, SG, CH, TN, UA, GB, TR, KG, MK / 77127

[51] Cl. 11-01

[54] 手鐲

Bracelet

[73] Harry Winston SA

Chemin du Tourbillon 8,
CH-1228 Plan-les-Ouates,
SWITZERLAND

[74] Spruson & Ferguson (Hong Kong) Limited

5001 Hopewell Centre,
183 Queen's Road East,
Hong Kong.



[11] 1802438.0M006

[15] 11-12-2018

[30] 16-11-2018 / EM, AZ, MC, AL, AM, BZ, GE, BA, LI, MN, ME, MA,
NO, OM, MD, SG, CH, TN, UA, GB, TR, KG, MK / 77127

[51] Cl. 11-01

[54] 手鐲

Bracelet

[73] Harry Winston SA

Chemin du Tourbillon 8,
CH-1228 Plan-les-Ouates,
SWITZERLAND

[74] Spruson & Ferguson (Hong Kong) Limited

5001 Hopewell Centre,
183 Queen's Road East,
Hong Kong.



[11] 1802438.0M007

[15] 11-12-2018

[30] 16-11-2018 / EM, AZ, MC, AL, AM, BZ, GE, BA, LI, MN, ME, MA,
NO, OM, MD, SG, CH, TN, UA, GB, TR, KG, MK / 77127

[51] Cl. 11-01

[54] 耳環

Earring

[73] Harry Winston SA

Chemin du Tourbillon 8,

CH-1228 Plan-les-Ouates,
SWITZERLAND

- [74] Spruson & Ferguson (Hong Kong) Limited
5001 Hopewell Centre,
183 Queen's Road East,
Hong Kong.



[11] 1802438.0M008

[15] 11-12-2018

[30] 16-11-2018 / EM, AZ, MC, AL, AM, BZ, GE, BA, LI, MN, ME, MA,
NO, OM, MD, SG, CH, TN, UA, GB, TR, KG, MK / 77127

[51] Cl. 11-01

[54] 指環
Ring

[73] Harry Winston SA
Chemin du Tourbillon 8,
CH-1228 Plan-les-Ouates,
SWITZERLAND

- [74] Spruson & Ferguson (Hong Kong) Limited
5001 Hopewell Centre,
183 Queen's Road East,
Hong Kong.



[11] 1802438.0M009

[15] 11-12-2018

[30] 16-11-2018 / AL, AZ, BA, BZ, CH, EM, GB, GE, KG, LI, MA, MC, MD, ME, MK, MN, NO, OM, SG, TN, TR, UA, AM / 77127

[51] Cl. 11-01

[54] 指環
Ring

[73] Harry Winston SA
Chemin du Tourbillon 8,
CH-1228 Plan-les-Ouates,
SWITZERLAND

[74] Spruson & Ferguson (Hong Kong) Limited
5001 Hopewell Centre,
183 Queen's Road East,
Hong Kong.



[11] 1802438.0M010

[15] 11-12-2018

[30] 16-11-2018 / EM, AZ, MC, AL, AM, BZ, GE, BA, LI, MN, ME, MA, NO, OM, MD, SG, CH, TN, UA, GB, TR, KG, MK / 77127

[51] Cl. 11-01

[54] 耳環
Earring

[73] Harry Winston SA
Chemin du Tourbillon 8,
CH-1228 Plan-les-Ouates,
SWITZERLAND

[74] Spruson & Ferguson (Hong Kong) Limited
5001 Hopewell Centre,
183 Queen's Road East,
Hong Kong.



[11] 1802438.0M011

[15] 11-12-2018

[30] 16-11-2018 / EM, AZ, MC, AL, AM, BZ, GE, BA, LI, MN, ME, MA,
NO, OM, MD, SG, CH, TN, UA, GB, TR, KG, MK / 77127

[51] Cl. 11-01

[54] 耳環
Earring

[73] Harry Winston SA
Chemin du Tourbillon 8,
CH-1228 Plan-les-Ouates,
SWITZERLAND

[74] Spruson & Ferguson (Hong Kong) Limited
5001 Hopewell Centre,
183 Queen's Road East,
Hong Kong.



[11] 1802438.0M012

[15] 11-12-2018

[30] 16-11-2018 / EM, AZ, MC, AL, AM, BZ, GE, BA, LI, MN, ME, MA,
NO, OM, MD, SG, CH, TN, UA, GB, TR, KG, MK / 77127

[51] Cl. 11-01

[54] 耳環

Earring

[73] Harry Winston SA

Chemin du Tourbillon 8,
CH-1228 Plan-les-Ouates,
SWITZERLAND

[74] Spruson & Ferguson (Hong Kong) Limited

5001 Hopewell Centre,
183 Queen's Road East,
Hong Kong.



[11] 1802438.0M013

[15] 11-12-2018

[30] 16-11-2018 / EM, AZ, MC, AL, AM, BZ, GE, BA, LI, MN, ME, MA,
NO, OM, MD, SG, CH, TN, UA, GB, TR, KG, MK / 77127

[51] Cl. 11-01

[54] 耳環

Earring

[73] Harry Winston SA

Chemin du Tourbillon 8,
CH-1228 Plan-les-Ouates,
SWITZERLAND

[74] Spruson & Ferguson (Hong Kong) Limited

5001 Hopewell Centre,
183 Queen's Road East,
Hong Kong.



[11] 1802438.0M014

[15] 11-12-2018

[30] 16-11-2018 / EM, AZ, MC, AL, AM, BZ, GE, BA, LI, MN, ME, MA,
NO, OM, MD, SG, CH, TN, UA, GB, TR, KG, MK / 77127

[51] Cl. 11-01

[54] 手鐲

Bracelet

[73] Harry Winston SA

Chemin du Tourbillon 8,
CH-1228 Plan-les-Ouates,
SWITZERLAND

[74] Spruson & Ferguson (Hong Kong) Limited

5001 Hopewell Centre,
183 Queen's Road East,
Hong Kong.



[11] 1802438.0M015

[15] 11-12-2018

[30] 16-11-2018 / EM, AZ, MC, AL, AM, BZ, GE, BA, LI, MN, ME, MA,
NO, OM, MD, SG, CH, TN, UA, GB, TR, KG, MK / 77127

[51] Cl. 11-01

[54] 項鍊

Necklace

[73] Harry Winston SA

Chemin du Tourbillon 8,
CH-1228 Plan-les-Ouates,
SWITZERLAND

[74] Spruson & Ferguson (Hong Kong) Limited

5001 Hopewell Centre,

183 Queen's Road East,
Hong Kong.



[11] 1802438.0M016

[15] 11-12-2018

[30] 16-11-2018 / EM, AZ, MC, AL, AM, BZ, GE, BA, LI, MN, ME, MA,
NO, OM, MD, SG, CH, TN, UA, GB, TR, KG, MK / 77127

[51] Cl. 11-01

[54] 項鍊
Necklace

[73] Harry Winston SA
Chemin du Tourbillon 8,
CH-1228 Plan-les-Ouates,
SWITZERLAND

[74] Spruson & Ferguson (Hong Kong) Limited
5001 Hopewell Centre,
183 Queen's Road East,
Hong Kong.



[11] 1802438.0M017

[15] 11-12-2018

[30] 16-11-2018 / EM, AZ, MC, AL, AM, BZ, GE, BA, LI, MN, ME, MA,
NO, OM, MD, SG, CH, TN, UA, GB, TR, KG, MK / 77127

[51] Cl. 11-01

[54] 耳環
Earring

[73] Harry Winston SA
Chemin du Tourbillon 8,

CH-1228 Plan-les-Ouates,
SWITZERLAND

- [74] Spruson & Ferguson (Hong Kong) Limited
5001 Hopewell Centre,
183 Queen's Road East,
Hong Kong.



-
- [11] 1802438.0M018
[15] 11-12-2018
[30] 16-11-2018 / EM, AZ, MC, AL, AM, BZ, GE, BA, LI, MN, ME, MA,
NO, OM, MD, SG, CH, TN, UA, GB, TR, KG, MK / 77127
[51] Cl. 11-01
[54] 指環
Ring
[73] Harry Winston SA
Chemin du Tourbillon 8,
CH-1228 Plan-les-Ouates,
SWITZERLAND
[74] Spruson & Ferguson (Hong Kong) Limited
5001 Hopewell Centre,
183 Queen's Road East,
Hong Kong.



-
- [11] 1802443.0M001

[15] 12-12-2018

[30] 12-06-2018 / US / 29/653,133

[51] Cl. 19-08

[54] 帶芯片的卡

Card with chip

[73] 蘋果公司

APPLE INC.

ONE APPLE PARK WAY, CUPERTINO,

CALIFORNIA 95014,

UNITED STATES

[74] CLT Patent & Trademark (H.K.) Ltd.

Unit 09, 34/F., Office Tower, Convention Plaza,

No. 1 Harbour Road, Wanchai,

Hong Kong.

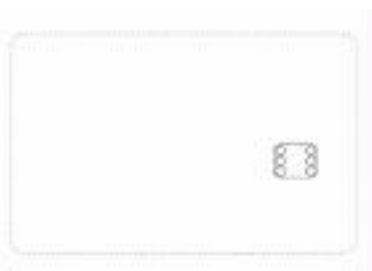

[11] 1802443.0M002

[15] 12-12-2018

[30] 12-06-2018 / US / 29/653,133

[51] Cl. 19-08

[54] 帶芯片的卡

Card with chip

[73] 蘋果公司

APPLE INC.

ONE APPLE PARK WAY, CUPERTINO,

CALIFORNIA 95014,

UNITED STATES

[74] CLT Patent & Trademark (H.K.) Ltd.

Unit 09, 34/F., Office Tower, Convention Plaza,

No. 1 Harbour Road, Wanchai,

Hong Kong.

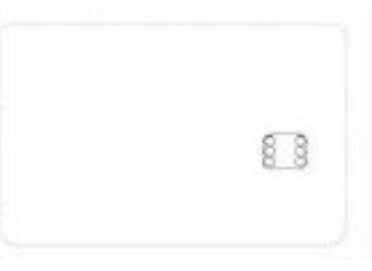

[11] 1802443.0M003

[15] 12-12-2018

[30] 12-06-2018 / US / 29/653,133

[51] Cl. 19-08

[54] 帶芯片的卡

Card with chip

[73] 蘋果公司

APPLE INC.

ONE APPLE PARK WAY, CUPERTINO,

CALIFORNIA 95014,

UNITED STATES

[74] CLT Patent & Trademark (H.K.) Ltd.

Unit 09, 34/F., Office Tower, Convention Plaza,

No. 1 Harbour Road, Wanchai,

Hong Kong.

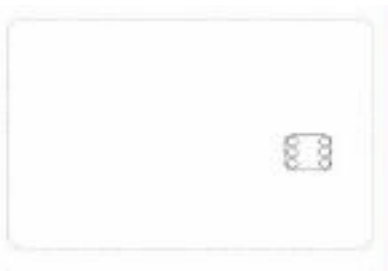

[11] 1802443.0M004

[15] 12-12-2018

[30] 12-06-2018 / US / 29/653,133

[51] Cl. 19-08

[54] 帶芯片的卡

Card with chip

[73] 蘋果公司

APPLE INC.

ONE APPLE PARK WAY, CUPERTINO,

CALIFORNIA 95014,

UNITED STATES

[74] CLT Patent & Trademark (H.K.) Ltd.

Unit 09, 34/F., Office Tower, Convention Plaza,

No. 1 Harbour Road, Wanchai,

Hong Kong.

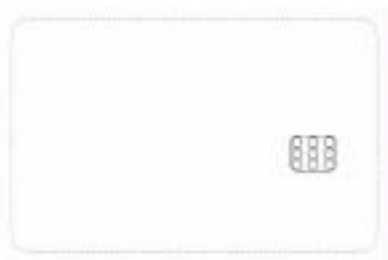

[11] 1802443.0M005

[15] 12-12-2018

[30] 12-06-2018 / US / 29/653,133

[51] Cl. 19-08

[54] 帶芯片的卡

Card with chip

[73] 蘋果公司

APPLE INC.

ONE APPLE PARK WAY, CUPERTINO,

CALIFORNIA 95014,

UNITED STATES

[74] CLT Patent & Trademark (H.K.) Ltd.

Unit 09, 34/F., Office Tower, Convention Plaza,

No. 1 Harbour Road, Wanchai,

Hong Kong.



[11] 1802443.0M006

[15] 12-12-2018

[30] 12-06-2018 / US / 29/653,133

[51] Cl. 19-08

[54] 帶芯片的卡

Card with chip

[73] 蘋果公司

APPLE INC.

ONE APPLE PARK WAY, CUPERTINO,

CALIFORNIA 95014,

UNITED STATES

- [74] CLT Patent & Trademark (H.K.) Ltd.
Unit 09, 34/F., Office Tower, Convention Plaza,
No. 1 Harbour Road, Wanchai,
Hong Kong.



-
- [11] 1802443.0M007
[15] 12-12-2018
[30] 12-06-2018 / US / 29/653,133
[51] Cl. 19-08
[54] 帶芯片的卡
Card with chip
[73] 蘋果公司
APPLE INC.
ONE APPLE PARK WAY, CUPERTINO,
CALIFORNIA 95014,
UNITED STATES
[74] CLT Patent & Trademark (H.K.) Ltd.
Unit 09, 34/F., Office Tower, Convention Plaza,
No. 1 Harbour Road, Wanchai,
Hong Kong.



-
- [11] 1802443.0M008
[15] 12-12-2018
[30] 12-06-2018 / US / 29/653,133
[51] Cl. 19-08
[54] 帶芯片的卡
Card with chip
[73] 蘋果公司
APPLE INC.

ONE APPLE PARK WAY, CUPERTINO,
CALIFORNIA 95014,
UNITED STATES

[74] CLT Patent & Trademark (H.K.) Ltd.
Unit 09, 34/F., Office Tower, Convention Plaza,
No. 1 Harbour Road, Wanchai,
Hong Kong.



[11] 1802443.0M009

[15] 12-12-2018

[30] 12-06-2018 / US / 29/653,133

[51] Cl. 19-08

[54] 帶芯片的卡
Card with chip

[73] 蘋果公司
APPLE INC.
ONE APPLE PARK WAY, CUPERTINO,
CALIFORNIA 95014,
UNITED STATES

[74] CLT Patent & Trademark (H.K.) Ltd.
Unit 09, 34/F., Office Tower, Convention Plaza,
No. 1 Harbour Road, Wanchai,
Hong Kong.

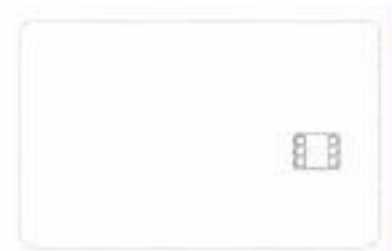

[11] 1802443.0M010

[15] 12-12-2018

[30] 12-06-2018 / US / 29/653,133

[51] Cl. 19-08

[54] 帶芯片的卡
Card with chip

[73] 蘋果公司
APPLE INC.
ONE APPLE PARK WAY, CUPERTINO,
CALIFORNIA 95014,
UNITED STATES

[74] CLT Patent & Trademark (H.K.) Ltd.
Unit 09, 34/F., Office Tower, Convention Plaza,
No. 1 Harbour Road, Wanchai,
Hong Kong.

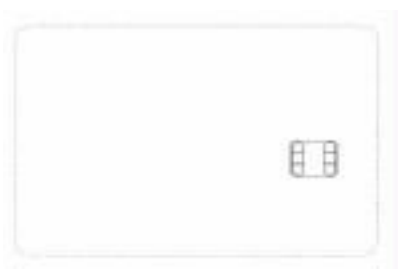

[11] 1802443.0M011

[15] 12-12-2018

[30] 12-06-2018 / US / 29/653,133

[51] Cl. 19-08

[54] 帶芯片的卡
Card with chip

[73] 蘋果公司
APPLE INC.
ONE APPLE PARK WAY, CUPERTINO,
CALIFORNIA 95014,
UNITED STATES

[74] CLT Patent & Trademark (H.K.) Ltd.
Unit 09, 34/F., Office Tower, Convention Plaza,
No. 1 Harbour Road, Wanchai,
Hong Kong.



[11] 1802443.0M012

- [15] 12-12-2018
- [30] 12-06-2018 / US / 29/653,133
- [51] Cl. 19-08
- [54] 帶芯片的卡
Card with chip
- [73] 蘋果公司
APPLE INC.
ONE APPLE PARK WAY, CUPERTINO,
CALIFORNIA 95014,
UNITED STATES
- [74] CLT Patent & Trademark (H.K.) Ltd.
Unit 09, 34/F., Office Tower, Convention Plaza,
No. 1 Harbour Road, Wanchai,
Hong Kong.

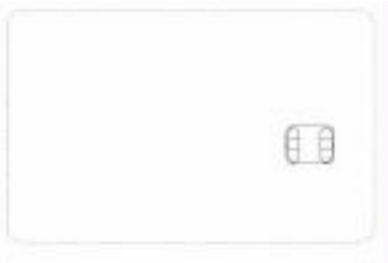

-
- [11] 1802443.0M013
- [15] 12-12-2018
- [30] 12-06-2018 / US / 29/653,133
- [51] Cl. 19-08
- [54] 帶芯片的卡
Card with chip
- [73] 蘋果公司
APPLE INC.
ONE APPLE PARK WAY, CUPERTINO,
CALIFORNIA 95014,
UNITED STATES
- [74] CLT Patent & Trademark (H.K.) Ltd.
Unit 09, 34/F., Office Tower, Convention Plaza,
No. 1 Harbour Road, Wanchai,
Hong Kong.

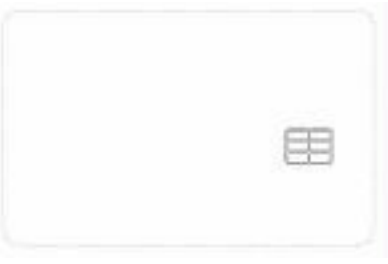

[11] 1802443.0M014

[15] 12-12-2018

[30] 12-06-2018 / US / 29/653,133

[51] Cl. 19-08

[54] 帶芯片的卡

Card with chip

[73] 蘋果公司

APPLE INC.

ONE APPLE PARK WAY, CUPERTINO,

CALIFORNIA 95014,

UNITED STATES

[74] CLT Patent & Trademark (H.K.) Ltd.

Unit 09, 34/F., Office Tower, Convention Plaza,

No. 1 Harbour Road, Wanchai,

Hong Kong.



[11] 1802443.0M015

[15] 12-12-2018

[30] 12-06-2018 / US / 29/653,133

[51] Cl. 19-08

[54] 帶芯片的卡

Card with chip

[73] 蘋果公司

APPLE INC.

ONE APPLE PARK WAY, CUPERTINO,

CALIFORNIA 95014,

UNITED STATES

[74] CLT Patent & Trademark (H.K.) Ltd.

Unit 09, 34/F., Office Tower, Convention Plaza,

No. 1 Harbour Road, Wanchai,

Hong Kong.

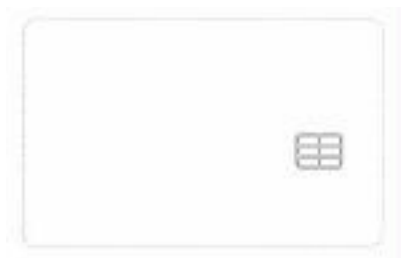

[11] 1802443.0M016

[15] 12-12-2018

[30] 12-06-2018 / US / 29/653,133

[51] Cl. 19-08

[54] 帶芯片的卡

Card with chip

[73] 蘋果公司

APPLE INC.

ONE APPLE PARK WAY, CUPERTINO,

CALIFORNIA 95014,

UNITED STATES

[74] CLT Patent & Trademark (H.K.) Ltd.

Unit 09, 34/F., Office Tower, Convention Plaza,

No. 1 Harbour Road, Wanchai,

Hong Kong.



[11] 1802443.0M017

[15] 12-12-2018

[30] 12-06-2018 / US / 29/653,133

[51] Cl. 19-08

[54] 帶芯片的卡

Card with chip

[73] 蘋果公司

APPLE INC.

ONE APPLE PARK WAY, CUPERTINO,

CALIFORNIA 95014,

UNITED STATES

- [74] CLT Patent & Trademark (H.K.) Ltd.
Unit 09, 34/F., Office Tower, Convention Plaza,
No. 1 Harbour Road, Wanchai,
Hong Kong.



-
- [11] 1802443.0M018
[15] 12-12-2018
[30] 12-06-2018 / US / 29/653,133
[51] Cl. 19-08
[54] 帶芯片的卡
Card with chip
[73] 蘋果公司
APPLE INC.
ONE APPLE PARK WAY, CUPERTINO,
CALIFORNIA 95014,
UNITED STATES
[74] CLT Patent & Trademark (H.K.) Ltd.
Unit 09, 34/F., Office Tower, Convention Plaza,
No. 1 Harbour Road, Wanchai,
Hong Kong.



-
- [11] 1802443.0M019
[15] 12-12-2018
[30] 12-06-2018 / US / 29/653,133
[51] Cl. 19-08
[54] 帶芯片的卡
Card with chip

[73] 蘋果公司

APPLE INC.
ONE APPLE PARK WAY, CUPERTINO,
CALIFORNIA 95014,
UNITED STATES

[74] CLT Patent & Trademark (H.K.) Ltd.

Unit 09, 34/F., Office Tower, Convention Plaza,
No. 1 Harbour Road, Wanchai,
Hong Kong.

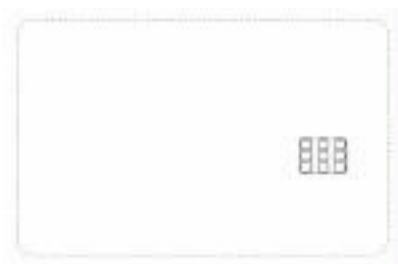

[11] 1802443.0M020

[15] 12-12-2018

[30] 12-06-2018 / US / 29/653,133

[51] Cl. 19-08

[54] 帶芯片的卡

Card with chip

[73] 蘋果公司

APPLE INC.
ONE APPLE PARK WAY, CUPERTINO,
CALIFORNIA 95014,
UNITED STATES

[74] CLT Patent & Trademark (H.K.) Ltd.

Unit 09, 34/F., Office Tower, Convention Plaza,
No. 1 Harbour Road, Wanchai,
Hong Kong.



[11] 1802443.0M021

[15] 12-12-2018

[30] 12-06-2018 / US / 29/653,133

[51] Cl. 19-08

[54] 帶芯片的卡

Card with chip

[73] 蘋果公司

APPLE INC.

ONE APPLE PARK WAY, CUPERTINO,

CALIFORNIA 95014,

UNITED STATES

[74] CLT Patent & Trademark (H.K.) Ltd.

Unit 09, 34/F., Office Tower, Convention Plaza,

No. 1 Harbour Road, Wanchai,

Hong Kong.



[11] 1802443.0M022

[15] 12-12-2018

[30] 12-06-2018 / US / 29/653,133

[51] Cl. 19-08

[54] 帶芯片的卡

Card with chip

[73] 蘋果公司

APPLE INC.

ONE APPLE PARK WAY, CUPERTINO,

CALIFORNIA 95014,

UNITED STATES

[74] CLT Patent & Trademark (H.K.) Ltd.

Unit 09, 34/F., Office Tower, Convention Plaza,

No. 1 Harbour Road, Wanchai,

Hong Kong.



[11] 1802443.0M023

[15] 12-12-2018

[30] 12-06-2018 / US / 29/653,133

[51] Cl. 19-08

[54] 帶芯片的卡

Card with chip

[73] 蘋果公司

APPLE INC.

ONE APPLE PARK WAY, CUPERTINO,

CALIFORNIA 95014,

UNITED STATES

[74] CLT Patent & Trademark (H.K.) Ltd.

Unit 09, 34/F., Office Tower, Convention Plaza,

No. 1 Harbour Road, Wanchai,

Hong Kong.



[11] 1802443.0M024

[15] 12-12-2018

[30] 12-06-2018 / US / 29/653,133

[51] Cl. 19-08

[54] 帶芯片的卡

Card with chip

[73] 蘋果公司

APPLE INC.

ONE APPLE PARK WAY, CUPERTINO,

CALIFORNIA 95014,

UNITED STATES

[74] CLT Patent & Trademark (H.K.) Ltd.

Unit 09, 34/F., Office Tower, Convention Plaza,

No. 1 Harbour Road, Wanchai,

Hong Kong.



[11] 1802443.0M025

[15] 12-12-2018

[30] 12-06-2018 / US / 29/653,133

[51] Cl. 19-08

[54] 帶芯片的卡

Card with chip

[73] 蘋果公司

APPLE INC.

ONE APPLE PARK WAY, CUPERTINO,

CALIFORNIA 95014,

UNITED STATES

[74] CLT Patent & Trademark (H.K.) Ltd.

Unit 09, 34/F., Office Tower, Convention Plaza,

No. 1 Harbour Road, Wanchai,

Hong Kong.



[11] 1802443.0M026

[15] 12-12-2018

[30] 12-06-2018 / US / 29/653,133

[51] Cl. 19-08

[54] 帶芯片的卡

Card with chip

[73] 蘋果公司

APPLE INC.

ONE APPLE PARK WAY, CUPERTINO,

CALIFORNIA 95014,

UNITED STATES

[74] CLT Patent & Trademark (H.K.) Ltd.

Unit 09, 34/F., Office Tower, Convention Plaza,

No. 1 Harbour Road, Wanchai,

Hong Kong.



[11] 1802443.0M027

[15] 12-12-2018

[30] 12-06-2018 / US / 29/653,133

[51] Cl. 19-08

[54] 帶芯片的卡

Card with chip

[73] 蘋果公司

APPLE INC.

ONE APPLE PARK WAY, CUPERTINO,

CALIFORNIA 95014,

UNITED STATES

[74] CLT Patent & Trademark (H.K.) Ltd.

Unit 09, 34/F., Office Tower, Convention Plaza,

No. 1 Harbour Road, Wanchai,

Hong Kong.



[11] 1802450.5M001

[15] 13-12-2018

[30] 23-10-2018 / DE / 40 2018 101 072.3

[51] Cl. 12-08

[54] 汽車

Motor vehicle

[73] VOLKSWAGEN AKTIENGESELLSCHAFT

38436 WOLFSBURG,

GERMANY

[74] China Patent Agent (H.K.) Ltd.

22/F, Great Eagle Centre,

23 Harbour Road, Wanchai,
Hong Kong.



[11] 1802450.5M002

[15] 13-12-2018

[30] 23-10-2018 / DE / 40 2018 101 072.3

[51] Cl. 12-08

[54] 汽車

Motor vehicle

[73] VOLKSWAGEN AKTIENGESELLSCHAFT
38436 WOLFSBURG,
GERMANY

[74] China Patent Agent (H.K.) Ltd.
22/F, Great Eagle Centre,
23 Harbour Road, Wanchai,
Hong Kong.



[11] 1802450.5M003

[15] 13-12-2018

[30] 23-10-2018 / DE / 40 2018 101 072.3

[51] Cl. 12-08

[54] 汽車

Motor vehicle

[73] VOLKSWAGEN AKTIENGESELLSCHAFT
38436 WOLFSBURG,
GERMANY

[74] China Patent Agent (H.K.) Ltd.
22/F, Great Eagle Centre,

23 Harbour Road, Wanchai,
Hong Kong.



-
- [11] 1802451.7
[15] 13-12-2018
[30] 23-10-2018 / DE / 40 2018 101 072.3
[51] Cl. 21-01
[54] 玩具汽車
Toy vehicle
[73] VOLKSWAGEN AKTIENGESELLSCHAFT
38436 WOLFSBURG,
GERMANY
[74] China Patent Agent (H.K.) Ltd.
22/F, Great Eagle Centre,
23 Harbour Road, Wanchai,
Hong Kong.



-
- [11] 1802453.1M001
[15] 13-12-2018
[51] Cl. 10-02
[54] 手錶
Watch
[73] 萬星企業(香港)股份有限公司
MASSINDO (HONG KONG) LIMITED
Flat 2, 15/F., Vanta Industrial Centre,
21-33 Tai Lin Pai Road, Kwai Chung,
N.T., Hong Kong
[74] Wilkinson & Grist
6th Floor, Prince's Building,
Chater Road,
Hong Kong.

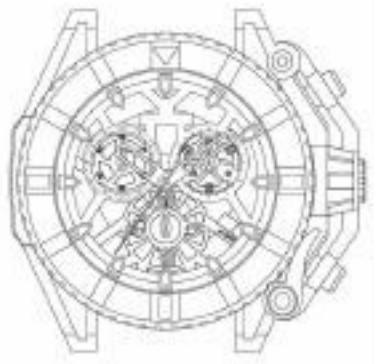

[11] 1802453.1M002

[15] 13-12-2018

[51] Cl. 10-02

[54] 手錶

Watch

[73] 萬星企業(香港)股份有限公司

MASSINDO (HONG KONG) LIMITED

Flat 2, 15/F., Vanta Industrial Centre,

21-33 Tai Lin Pai Road, Kwai Chung,

N.T., Hong Kong

[74] Wilkinson & Grist

6th Floor, Prince's Building,

Chater Road,

Hong Kong.

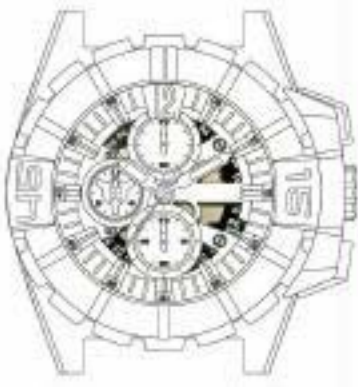

[11] 1802454.3

[15] 13-12-2018

[30] 20-07-2018 / EM / 005510047-0001

[51] Cl. 9-01

[54] 香水產品瓶

Flask for perfumery products

[73] PARFUMS CHRISTIAN DIOR
33 Avenue Hoche - 75008 PARIS,
FRANCE

[74] WENPING & CO.
1701 Tung Wai Commercial Building,
111 Gloucester Road,
Hong Kong.



[11] 1802455.6

[15] 13-12-2018

[30] 20-07-2018 / EM / 005510047-0002

[51] Cl. 9-07

[54] 香水產品瓶蓋

Cap for flask for perfumery products

[73] PARFUMS CHRISTIAN DIOR
33 Avenue Hoche - 75008 PARIS,
FRANCE

[74] WENPING & CO.
1701 Tung Wai Commercial Building,
111 Gloucester Road,
Hong Kong.



- [11] 1802457.0
[15] 13-12-2018
[51] Cl. 9-03
[54] 包裝盒
Packaging box
[73] 日本佐川藥業株式會社有限公司
香港新界沙田
源順圍
沙田工業中心 A 座 3/F 3 室
[74] 天標知識產權代理有限公司
香港九龍尖沙咀
加連威老道 14 號 加連威
大廈 4 樓 A 座



-
- [11] 1802460.6
[15] 13-12-2018
[51] Cl. 28-03
[54] 美唇按摩器
Massage device for beautifying lips
[73] 王海濤
中國內地廣東省深圳市
寶安區西鄉固戍順昌路 華豐第一科
技園 B 區茶西二棟七樓
[74] 理士知識產權集團（國際）有限公司
香港九龍旺角
花園街 2-16 號
好景商業中心 2709 室



[11] 1802461.8

[15] 13-12-2018

[30] 26-06-2018 / EM / 005324803

[51] Cl. 9-01

[54] 用於化妝品, 香水及類似物的容器

Container for cosmetics, scents and similar

[73] COSVAL S.p.A.

Via Giosuè Carducci 2 -20123 MILANO,
ITALY

[74] Spruson & Ferguson (Hong Kong) Limited

5001 Hopewell Centre,
183 Queen's Road East,
Hong Kong.



[11] 1802463.2

[15] 14-12-2018

[51] Cl. 11-01

[54] 卡扣式手鐲

Clasp bracelet

[73] 深圳市金芝尚珠寶有限公司

中國內地深圳市龍崗區

南灣街道上李朗社區布瀾路 中盛科技園六
棟四樓

- [74] 港智國際知識產權代理有限公司
香港屯門
震寰路 3 號
德榮工業大廈 20 字樓 B6 室



-
- [11] 1802465.7
[15] 14-12-2018
[30] 31-07-2018 / JP / 016826 of 2016
[51] Cl. 9-05
[54] 包裝用箱
Packaging pouch
[73] Graphico 株式會社
Kabushiki Kaisha Graphico
日本東京都
品川區
大崎一丁目 6 番 1 號
[74] 香港商標 & 設計代理有限公司
香港 金鐘道 89 號
力寶中心 2 期
28 樓 2802 室



-
- [11] 1802467.1

- [15] 14-12-2018
- [30] 15-06-2018 / AU / 201813620
- [51] Cl. 7-02
- [54] 鍋
Pot
- [73] Sea to Summit Pty Ltd
5 Eyre Street, Rivervale,
Western Australia 6103,
AUSTRALIA
- [74] Barron & Young Intellectual Property Limited
Suite 617, Lakeside 2,
No. 10 Science Park West Avenue,
Hong Kong Science Park, N.T., Hong Kong.



-
- [11] 1802468.3
- [15] 14-12-2018
- [51] Cl. 28-03
- [54] 矽膠加熱睫毛器
Silicone heated eyelash curler
- [73] 渲美美健(深圳)科技股份有限公司
中國內地廣東省深圳市寶安區
新安街道寶安中心區興華路南側 榮超濱海
大廈 A 座七樓
- [74] 恆大律師行香港有限公司
香港中環
皇后大道中 70 號
卡佛大廈 1104 室



[11] 1802469.5

[15] 14-12-2018

[51] Cl. 10-05

[54] 用於街燈的智能裝置容器

Vessel for smart device for lamppost

[73] Ticktack Technology Limited

House 60, Casa Marina I,

28 Lo Fai Road, Tai Po,

N.T., Hong Kong

[74] Accolade IP Limited

Room 702, 7/F.,

Fu Fai Commercial Centre,

27 Hillier Street, Hong Kong.



[11] 1802470.7

[15] 14-12-2018

[51] Cl. 22-01

[54] 彈匣

Magazine

[73] 共榮股份有限公司

PTS SYNDICATE LIMITED

ROOM 608, 6/F.,

GLOBAL GATEWAY TOWER,

NO. 63 WING HONG STREET, CHEUNG SHA WAN, KOWLOON, HONG KONG

- [74] BENNY KONG & TSAI
Unit 19B, Overseas Trust Bank Building,
No. 160 Gloucester Road, Wanchai,
Hong Kong.



-
- [11] 1802471.9
[15] 17-12-2018
[30] 19-06-2018 / DE / 40 2018 100 600.9
[51] Cl. 21-01
[54] 玩具汽車
Toy vehicle
[73] VOLKSWAGEN AKTIENGESELLSCHAFT
38436 WOLFSBURG,
GERMANY
[74] China Patent Agent (H.K.) Ltd.
22/F, Great Eagle Centre,
23 Harbour Road, Wanchai,
Hong Kong.



-
- [11] 1802473.3M001
[15] 17-12-2018
[30] 19-06-2018 / DE / 40 2018 100 600.9
[51] Cl. 12-08
[54] 汽車
Motor vehicle

[73] VOLKSWAGEN AKTIENGESELLSCHAFT
38436 WOLFSBURG,
GERMANY

[74] China Patent Agent (H.K.) Ltd.
22/F, Great Eagle Centre,
23 Harbour Road, Wanchai,
Hong Kong.



[11] 1802473.3M002

[15] 17-12-2018

[30] 19-06-2018 / DE / 40 2018 100 600.9

[51] Cl. 12-08

[54] 汽車

Motor vehicle

[73] VOLKSWAGEN AKTIENGESELLSCHAFT
38436 WOLFSBURG,
GERMANY

[74] China Patent Agent (H.K.) Ltd.
22/F, Great Eagle Centre,
23 Harbour Road, Wanchai,
Hong Kong.



[11] 1802473.3M003

[15] 17-12-2018

[30] 19-06-2018 / DE / 40 2018 100 600.9

[51] Cl. 12-08

[54] 汽車

Motor vehicle

[73] VOLKSWAGEN AKTIENGESELLSCHAFT
38436 WOLFSBURG,
GERMANY

[74] China Patent Agent (H.K.) Ltd.
22/F, Great Eagle Centre,
23 Harbour Road, Wanchai,
Hong Kong.



[11] 1802476.0

[15] 17-12-2018

[30] 07-12-2018 / EM / 005846961-0001

[51] Cl. 31-00

[54] 用於製備飲料的(電子)機器或設備
Machines or appliances for preparing beverages (electronic)

[73] FrieslandCampina Nederland B.V.
Stationsplein 4,
3818 LE Amersfoort,
NETHERLANDS

[74] So Keung Yip & Sin, Solicitors & Notaries, Agents for Trade
Marks, Patents & Designs
1009-1012, 10/F, Nan Fung Tower,
173 Des Voeux Road,
Central, Hong Kong.



[11] 1802480.8

[15] 18-12-2018

[51] Cl. 28-03

[54] 電動鼻毛修剪器

Electric nose hair trimmer

[73] 渲美美健(深圳)科技股份有限公司

中國內地廣東省深圳市寶安區

新安街道寶安中心區興華路南側 榮超濱海

大廈 A 座七樓

[74] 恆大律師行香港有限公司

香港中環

皇后大道中 70 號

卡佛大廈 1104 室



[11] 1802481.0

[15] 18-12-2018

[51] Cl. 21-01

[54] 玩具載具

Toy vehicle

[73] Gakken (Hong Kong) Company Limited

Rm 1201, Fourseas Bldg.,

208-212 Nathan Road,

Kowloon, Hong Kong

[74] Accolade IP Limited

Room 702, 7/F.,

Fu Fai Commercial Centre,

27 Hillier Street, Hong Kong.



- [11] 1802482.2
[15] 18-12-2018
[51] Cl. 7-01
[54] 波浪工藝啤酒杯
Wave craft beer cup
[73] KUNG Wan Ho
G/F, On Wing Building,
59 Bonham Strand East,
Sheung Wan, Hong Kong
[74] Global Intellectual Property Company Limited
Unit 2205, 22/F, Sino Plaza,
255-257 Gloucester Road,
Causeway Bay, Hong Kong.



-
- [11] 1802485.9
[15] 18-12-2018
[51] Cl. 13-02
[54] 2合1旅行轉插器及充電器
2 in 1 travel power adapter and power bank
[73] FUNN GROUP LIMITED
香港九龍尖沙咀 加連威
老道 21A-B 德立大廈 6
樓 602 室
FLAT/RM 602, 6/F,
TAURUS BUILDING,
21A-B GRANVILLE ROAD, TSIM SHA TSUI, KL
[74] 天標知識產權代理有限公司
香港九龍尖沙咀
加連威老道 14 號 加連威
大廈 4 樓 A 座



-
- [11] 1802486.1
[15] 19-12-2018
[51] Cl. 9-03
[54] 急凍韓國蠔肉包裝袋
Packaging bag of frozen Korean oyster
[73] Onric Development Company Ltd.
香港香港仔 田灣
海旁道 7 號
興偉工業中心 6 樓 613B 室
[74] Onric Development Company Ltd.
香港香港仔 田灣
海旁道 7 號
興偉工業中心 6 樓 613B 室



-
- [11] 1802490.9
[15] 19-12-2018
[30] 19-06-2018 / JP / 14808 of 2018

[51] Cl. 24-99

[54] 用於牙齒漂白的輻照機體

Irradiation machine body for tooth bleaching

[73] SUGIYAMA Takehiro

Saito Building 5th Floor,

3-13, Higashi Ueno 3-chome, Taito-ku,

Tokyo, 110-0015, JAPAN

[74] HASTINGS & CO.

5th Floor, Gloucester Tower,

The Landmark, 11 Pedder Street,

Central, Hong Kong.



[11] 1802491.1

[15] 19-12-2018

[30] 13-11-2018 / JP / 024783 of 2018

[51] Cl. 23-03

[54] 暖眼罩

Eye Warmer

[73] Kabushiki Kaisha Atekkusu (ATEX Co., Ltd.)

3-24, Nagayoshi-Kawanabe 3-Chome,

Hirano-Ku, Osaka 547-0014,

JAPAN

[74] EMILY YIP & CO

1st Floor, Kingsfield Centre,

18 Shell Street, Fortress Hill,

Hong Kong.



[11] 1802493.5

[15] 19-12-2018

[51] Cl. 21-01

[54] 玩具氣槍下身

Airsoft gun lower body

[73] JK Division Holdings Limited

RM5&6, 21/F, Prosper Commercial Building,
9 Yin Chong Street, Mong Kok,
Kowloon, Hong Kong

[74] Accolade IP Limited

Room 702, 7/F.,
Fu Fai Commercial Centre,
27 Hillier Street, Hong Kong.



[11] 1802494.7

[15] 19-12-2018

[30] 13-11-2018 / JP / 024784 of 2018

[51] Cl. 28-03

[54] 按摩器具

Massage apparatus

[73] Kabushiki Kaisha Atekkusu (ATEX Co., Ltd.)

3-24, Nagayoshi-Kawanabe 3-Chome,
Hirano-Ku, Osaka 547-0014,
JAPAN

[74] EMILY YIP & CO

1st Floor, Kingsfield Centre,
18 Shell Street, Fortress Hill,
Hong Kong.



[11] 1802501.5M001

[15] 20-12-2018

[30] 20-06-2018 / US / 29/654,009

[51] Cl. 3-01

[54] 行李箱

Luggage

[73] 途明股份有限公司

TUMI, INC.

1001 Durham Avenue,

South Plainfield,

New Jersey 07080 United States

[74] Shanghai Intellectual Property Office

Unit F, 20th Floor,

Neich Tower, 128 Gloucester Road,

Hong Kong



[11] 1802501.5M002

[15] 20-12-2018

[30] 20-06-2018 / US / 29/654,009

[51] Cl. 3-01

[54] 行李箱

Luggage

[73] 途明股份有限公司

TUMI, INC.

1001 Durham Avenue,

South Plainfield,

New Jersey 07080 United States

[74] Shanghai Intellectual Property Office

Unit F, 20th Floor,

Neich Tower, 128 Gloucester Road,
Hong Kong



[11] 1802501.5M003

[15] 20-12-2018

[30] 20-06-2018 / US / 29/654,009

[51] Cl. 3-01

[54] 行李箱

Luggage

[73] 途明股份有限公司

TUMI, INC.

1001 Durham Avenue,

South Plainfield,

New Jersey 07080 United States

[74] Shanghai Intellectual Property Office

Unit F, 20th Floor,

Neich Tower, 128 Gloucester Road,

Hong Kong



[11] 1802501.5M004

[15] 20-12-2018

[30] 20-06-2018 / US / 29/654,013

[51] Cl. 3-01

[54] 行李箱

Luggage

[73] 途明股份有限公司

TUMI, INC.

1001 Durham Avenue,

South Plainfield,

New Jersey 07080 United States

[74] Shanghai Intellectual Property Office

Unit F, 20th Floor,

Neich Tower, 128 Gloucester Road,

Hong Kong

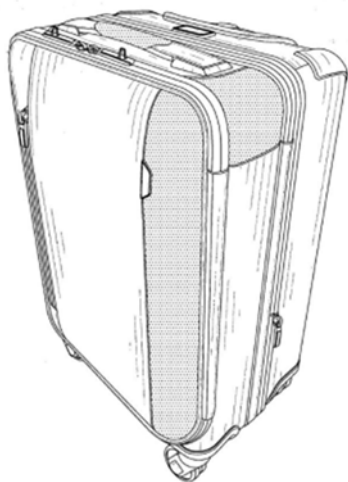

[11] 1802501.5M005

[15] 20-12-2018

[30] 20-06-2018 / US / 29/654,013

[51] Cl. 3-01

[54] 行李箱

Luggage

[73] 途明股份有限公司

TUMI, INC.

1001 Durham Avenue,

South Plainfield,

New Jersey 07080 United States

[74] Shanghai Intellectual Property Office

Unit F, 20th Floor,

Neich Tower, 128 Gloucester Road,

Hong Kong

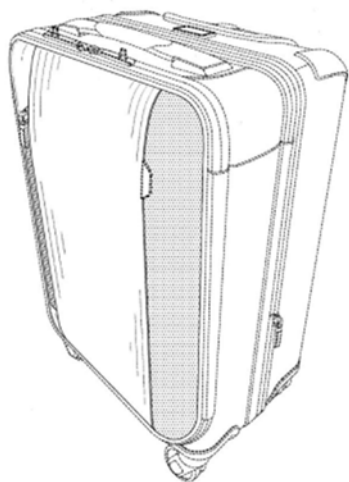

[11] 1802501.5M006

[15] 20-12-2018

[30] 20-06-2018 / US / 29/654,013

[51] Cl. 3-01

[54] 行李箱

Luggage

[73] 途明股份有限公司

TUMI, INC.

1001 Durham Avenue,

South Plainfield,

New Jersey 07080 United States

[74] Shanghai Intellectual Property Office

Unit F, 20th Floor,

Neich Tower, 128 Gloucester Road,
Hong Kong



[11] 1802501.5M007

[15] 20-12-2018

[30] 20-06-2018 / US / 29/654,017

[51] Cl. 3-01

[54] 背包

Backpack

[73] 途明股份有限公司

TUMI, INC.

1001 Durham Avenue,

South Plainfield,

New Jersey 07080 United States

[74] Shanghai Intellectual Property Office

Unit F, 20th Floor,

Neich Tower, 128 Gloucester Road,

Hong Kong



[11] 1802501.5M008

[15] 20-12-2018

[30] 20-06-2018 / US / 29/654,017

[51] Cl. 3-01

[54] 背包

Backpack

[73] 途明股份有限公司

TUMI, INC.

1001 Durham Avenue,

South Plainfield,

New Jersey 07080 United States

[74] Shanghai Intellectual Property Office

Unit F, 20th Floor,

Neich Tower, 128 Gloucester Road,

Hong Kong



- [11] 1802501.5M009
- [15] 20-12-2018
- [30] 20-06-2018 / US / 29/654,017
- [51] Cl. 3-01
- [54] 背包
Backpack
- [73] 途明股份有限公司
TUMI, INC.
1001 Durham Avenue,
South Plainfield,
New Jersey 07080 United States
- [74] Shanghai Intellectual Property Office
Unit F, 20th Floor,
Neich Tower, 128 Gloucester Road,
Hong Kong



-
- [11] 1802501.5M010
 - [15] 20-12-2018
 - [30] 20-06-2018 / US / 29/654,022
 - [51] Cl. 3-01
 - [54] 公文包
Briefcase
 - [73] 途明股份有限公司
TUMI, INC.
1001 Durham Avenue,
South Plainfield,
New Jersey 07080 United States
 - [74] Shanghai Intellectual Property Office
Unit F, 20th Floor,

Neich Tower, 128 Gloucester Road,
Hong Kong



[11] 1802501.5M011

[15] 20-12-2018

[30] 20-06-2018 / US / 29/654,022

[51] Cl. 3-01

[54] 公文包

Briefcase

[73] 途明股份有限公司

TUMI, INC.

1001 Durham Avenue,

South Plainfield,

New Jersey 07080 United States

[74] Shanghai Intellectual Property Office

Unit F, 20th Floor,

Neich Tower, 128 Gloucester Road,

Hong Kong



[11] 1802501.5M012

[15] 20-12-2018

[30] 20-06-2018 / US / 29/654,022

[51] Cl. 3-01

[54] 公文包

Briefcase

[73] 途明股份有限公司

TUMI, INC.

1001 Durham Avenue,

South Plainfield,

New Jersey 07080 United States

[74] Shanghai Intellectual Property Office

Unit F, 20th Floor,

Neich Tower, 128 Gloucester Road,

Hong Kong



[11] 1802502.7M001

[15] 20-12-2018

[51] Cl. 5-05

[54] 織物

Fabrics

[73] Cath Kidston Limited

2nd Floor, Frestonia,

125-135 Freston Road, London W10 6TH,

UNITED KINGDOM

[74] Robin Bridge & John Liu

6th Floor, Emperor Commercial Centre,

39 Des Voeux Road Central,

Hong Kong



[11] 1802502.7M002

[15] 20-12-2018

[51] Cl. 5-05

[54] 織物

Fabrics

[73] Cath Kidston Limited

2nd Floor, Frestonia, 125-135 Freston Road, London W10 6TH,

UNITED KINGDOM

[74] Robin Bridge & John Liu

6th Floor, Emperor Commercial Centre, 39 Des Voeux Road

Central, Hong Kong



[11] 1802502.7M003

[15] 20-12-2018

[51] Cl. 5-05

[54] 織物

Fabrics

[73] Cath Kidston Limited

2nd Floor, Frestonia, 125-135 Freston Road, London W10 6TH,
UNITED KINGDOM

[74] Robin Bridge & John Liu

6th Floor, Emperor Commercial Centre, 39 Des Voeux Road
Central, Hong Kong



[11] 1802502.7M004

[15] 20-12-2018

[51] Cl. 5-05

[54] 織物

Fabrics

[73] Cath Kidston Limited

2nd Floor, Frestonia, 125-135 Freston Road, London W10 6TH,
UNITED KINGDOM

[74] Robin Bridge & John Liu

6th Floor, Emperor Commercial Centre, 39 Des Voeux Road
Central, Hong Kong



[11] 1802502.7M005

[15] 20-12-2018

[51] Cl. 5-05

[54] 織物

Fabrics

[73] Cath Kidston Limited

2nd Floor, Frestonia, 125-135 Freston Road, London W10 6TH,
UNITED KINGDOM

[74] Robin Bridge & John Liu

6th Floor, Emperor Commercial Centre, 39 Des Voeux Road
Central, Hong Kong



[11] 1802503.9

[15] 20-12-2018

[30] 21-06-2018 / CN / 201830321993.1

[51] Cl. 15-09

[54] 3D 打印機
3D printer

[73] 北京京東世紀貿易有限公司
BEIJING JINGDONG CENTURY TRADING CO., LTD.
中國內地 北京市
大興區
北京經濟技術開發區科創十一街 18 號 C 座 2 層 201 室

北京京東尚科信息技術有限公司
BEIJING JINGDONG SHANGKE INFORMATION TECHNOLOGY CO., LTD.
中國內地 北京市
海淀區 知春路 76
號 8 層

[74] 隆天專利商標代理有限公司
香港九龍
青山道 485 號
九龍廣場 10 樓 11 室

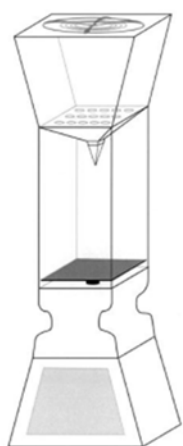

主視圖

[11] 1802506.6

[15] 20-12-2018

[30] 26-07-2018 / US / 29/657,881

[51] Cl. 14-99

[54] 固定流動電話的裝置

Mobile device mount

[73] DaVinci II CSJ, LLC

79 Two Bridges Road,
Fairfield, New Jersey 07004,
UNITED STATES

[74] Spruson & Ferguson (Hong Kong) Limited

5001 Hopewell Centre,
183 Queen's Road East,
Hong Kong.

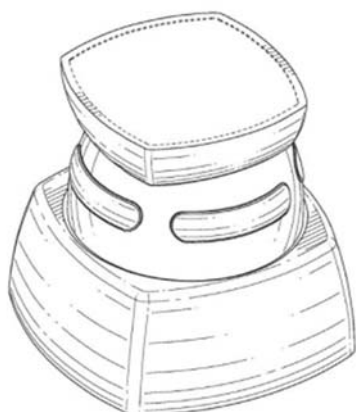

- [11] 1802517.9
[15] 21-12-2018
[30] 26-06-2018 / EM / 005325271-0001
[51] Cl. 2-04
[54] 鞋
Shoes
[73] adidas AG
Adi-Dassler-Strasse 1,
91074 Herzogenaurach,
GERMANY
[74] Mayer Brown
16th-19th Floors, Prince's Building,
10 Chater Road, Central,
Hong Kong.



-
- [11] 1900112.8M001
[15] 18-01-2019
[30] 20-07-2018 / DE / 40 2018 100 722.6
[51] Cl. 21-01
[54] 玩具或比例模型車
Toy or scale model vehicle
[73] Bayerische Motoren Werke Aktiengesellschaft
Petuelring 130,
80809, Muenchen,
GERMANY
[74] HASTINGS & CO.
5th Floor, Gloucester Tower,
The Landmark, 11 Pedder Street,
Central, Hong Kong.



[11] 1900112.8M002

[15] 18-01-2019

[30] 20-07-2018 / DE / 40 2018 100 722.6

[51] Cl. 21-01

[54] 玩具或比例模型車

Toy or scale model vehicle

[73] Bayerische Motoren Werke Aktiengesellschaft

Petuelring 130,
80809, Muenchen,
GERMANY

[74] HASTINGS & CO.

5th Floor, Gloucester Tower,
The Landmark, 11 Pedder Street,
Central, Hong Kong.





香港特別行政區政府知識產權署外觀設計註冊處

The Government of the Hong Kong Special Administrative Region

Designs Registry, Intellectual Property Department

根據註冊外觀設計條例第28條，下列註冊外觀設計因未繳續期費而停止有效。各組記項按註冊外觀設計停止有效日期及註冊編號先後次序排列。

Registered designs ceased through non-payment of renewal fees under section 28 of the Registered Designs Ordinance. Entries are listed below under their expiry dates.

23-05-2019 - 28-05-2019

23-05-2019	1400975.3M003	1401000.7M002
0411163.1	1400975.3M004	1401000.7M003
0411164.3		1401001.9
0411165.6	26-05-2019	1401003.3
1400968.8	1400977.7M002	1401004.5
9910638.3	1400979.1M001	1401005.8M001
9910639.5M001	1400979.1M002	1401006.0M001
9910639.5M002	1400979.1M003	1401006.0M002
9910640.7M001	1400980.3	1401007.2M001
9910640.7M002		1401007.2M002

27-05-2019

24-05-2019	1400988.0	1401010.8
0411175.7	1400991.6M001	
	1400991.6M002	

25-05-2019

0900847.5M001	1400991.6M003	
0900847.5M002	1400992.8M001	
0900847.5M003	1400992.8M002	
0900847.5M004	1400993.0M001	
0900848.7	1400993.0M002	
0900849.9	1400994.2	
0900850.1	1400995.5	
0900851.3	1400996.7	
0900852.5	1400997.9	
0900853.7	9910658.5	

28-05-2019

0900854.9	1400991.6M003	
1400969.0	1400992.8M001	
1400970.2	1400992.8M002	
1400971.4	1400993.0M001	
1400972.6	1400993.0M002	
1400973.8	1400994.2	
1400974.0	1400995.5	
1400975.3M001	1400996.7	
1400975.3M002	1400997.9	
	9910658.5	
	28-05-2019	
	0900883.0	
	0900884.2	
	0900885.5	
	0900886.7	
	0900887.9	
	0900888.1	
	0900889.3	
	1401000.7M001	



香港特別行政區政府知識產權署外觀設計註冊處

The Government of the Hong Kong Special Administrative Region

Designs Registry, Intellectual Property Department

根據註冊外觀設計規則第 31 條刪除的註冊外觀設計。各組記項按註冊外觀設計 刪除日期及註冊編號先後次序排列。

Registered designs removed under section 31 of the Registered Designs Rules. Entries are listed below under their removal dates.

31-05-2019 - 05-06-2019

31-05-2019	1302096.9M004	0802830.0
0312038.7	1302096.9M005	0802831.2M001
9811502.5	1302096.9M006	0802831.2M002
	1302096.9M007	0802832.4M001

01-06-2019		0802832.4M002
-------------------	--	---------------

0802797.9M002	03-06-2019	1302107.4
0802797.9M003	0312048.8	1302108.6
0802797.9M004	0312052.6	1302110.0M001
0802797.9M005	0802821.1M001	1302110.0M002
0802799.3	0802821.1M002	1302110.0M003
0802801.9	0802821.1M003	1302110.0M004
1302086.8	0802821.1M004	1302111.2M001
1302087.0M001	0802823.5	1302111.2M002
1302087.0M003	1302098.3	1302111.2M003
1302087.0M004	1302099.5M002	1302111.2M004
1302088.2M001	1302099.5M003	1302113.6
1302088.2M002	1302101.1	1302114.8
1302090.6	1302102.3	1302115.1

02-06-2019	1302103.5M003	1302116.3
0802807.2	1302103.5M004	1302117.5M001
0802808.4	1302103.5M005	1302117.5M002
0802813.4	1302103.5M006	1302117.5M003
0802814.6	9811522.7	1302118.7M001

0802815.9	04-06-2019	1302118.7M002
0802816.1	0312065.4M001	1302118.7M003
0900293.8M001	0312065.4M002	1302118.7M004
0900293.8M002	0312065.4M003	1302118.7M005
0900293.8M003	0312065.4M004	1302118.7M006
1302092.0	0312066.6M001	1302118.7M007
1302093.2	0312066.6M002	1302118.7M008
1302096.9M001	0312066.6M003	1302118.7M009
1302096.9M002	0312066.6M004	1302118.7M010
1302096.9M003	0802828.6M001	1302118.7M011
	0802828.6M002	1302118.7M012

1302118.7M013
1302118.7M014
1302118.7M015
1302118.7M016
1302118.7M017
1302118.7M018
1302118.7M019
1302120.1

05-06-2019

1302124.9
1302125.2M001
1302125.2M002
1302125.2M003
1302125.2M004
1302125.2M005
1302125.2M006
1302125.2M007
1302125.2M008
1302125.2M009
1302125.2M010
1302125.2M011
1302125.2M012
1302125.2M013
1302125.2M014
1302125.2M015
1302125.2M016
1302125.2M017
1302125.2M018
1302128.8
1302129.0
1302130.2
1302131.4
1302132.6
1302136.5
1302137.7