

香港知識產權公報

Hong Kong Intellectual Property Journal

2021年10月22日
22 October 2021

目錄 Contents

根據註冊外觀設計條例第 25 條註冊的外觀設計

Designs Registered under section 25 of the Registered Designs Ordinance

按註冊編號排列

Arranged by Registration Number

根據註冊外觀設計條例(第 522 章)公布的其他公告

Other Notices Published under the Registered Designs Ordinance (Cap. 522)

根據註冊外觀設計條例第 28 條，註冊外觀設計因未繳續期費而停止有效

Registered designs ceased through non-payment of renewal fees under section 28 of the Registered Designs Ordinance

根據註冊外觀設計規則第 31 條刪除的註冊外觀設計

Registered designs removed under section 31 of the Registered Designs Rules

以下事項沒有記錄

No Records for the Following Matters

根據註冊外觀設計條例第 30 條放棄的外觀設計的註冊

Surrender of Registration of Design under section 30 of the Registered Designs Ordinance

根據註冊外觀設計規則第 37 條，向處長作出轉介

Reference to Registrar under section 37 of the Registered Designs Rules

根據註冊外觀設計條例第 45 條，撤銷註冊

Revocation of Registration under section 45 of the Registered Designs Ordinance

根據註冊外觀設計規則第 46 條，向法院作出轉介

Reference to Court under section 46 of the Registered Designs Rules

根據註冊外觀設計規則第 63 條對不符合規定之處作出糾正

Rectification of Irregularities under section 63 of the Registered Designs Rules

根據註冊外觀設計條例第 66 條，糾正註冊紀錄冊

Rectification of Register under section 66 of the Registered Designs Ordinance

根據註冊外觀設計條例第 67 條 更正註冊紀錄冊內的錯誤

Correction of errors in Register under section 67 of the Registered Designs Ordinance

根據註冊外觀設計條例第 67 及 76 條，更正註冊紀錄冊內及已提交文件中的錯誤

Correction of Errors in Register and in Filed Documents under sections 67 and 76 of the Registered Designs Ordinance

根據註冊外觀設計條例第 76 條，更正已提交文件中的錯誤

Correction of errors in filed documents under section 76 of the Registered Designs Ordinance

勘誤

Corrigendum

註冊外觀設計公告註釋

Notes on advertisements of registration of designs

方括號表示下列資料：

Square brackets indicate the following data：

[11] 註冊編號 Registration number / 聯合王國註冊編號 United Kingdom registration number

[15] 註冊日期 Registration date / 當作註冊日期 Deemed registration date / 聯合王國註冊日期 United Kingdom registration date

[17] 註冊有效期屆滿日期 Expiry date of the period of registration

[22] 提交日期 Filing date / 當作提交日期 Deemed filing date / 聯合王國提交日期 United Kingdom filing date

[30] 聲稱享有的優先權（提交日期 / 巴黎公約國或世界貿易組織成員 / 申請編號） Priority claimed (filing date / Paris Convention country or WTO member / application number)

[51] 國際外觀設計分類號（洛迦諾分類號） International Classification of designs (Locarno Classification)

[54] 物品 Article

[55] 外觀設計的表述 Representation of the design

[62] 分開前的申請編號及提交日期 Application number before division and filing date

[66] 過往註冊的聯繫外觀設計註冊編號 / 日期 Registration No. / Date of Previous Registration for Association

[72] 設計人 Designer

[73] 擁有人姓名和地址 Name and address of the owner

[74] 代理人 Agent /送達地址 Address for service



香港特別行政區政府知識產權署外觀設計註冊處

The Government of the Hong Kong Special Administrative Region

Designs Registry, Intellectual Property Department

根據註冊外觀設計條例第 25 條註冊的外觀設計

Designs registered under section 25 of the Registered Designs Ordinance

按註冊編號排列

Arranged by Registration Number

[11] 2016998.7M001

[15] 23-10-2020

[30] 24-04-2020 / CH, GB, EU / DM/208 144

[51] Cl. 16-06

[54] 具可拆卸鏡片的放大鏡

Magnifying glasses with removable lens

[73] Richemont International SA

Route des Biches 10,

1752 Villars-sur-Glâne,

Switzerland

[74] UNION PATENT SERVICE CENTRE

Units E-F, 20th Floor, Neich Tower,

128 Gloucester Road,

Hong Kong

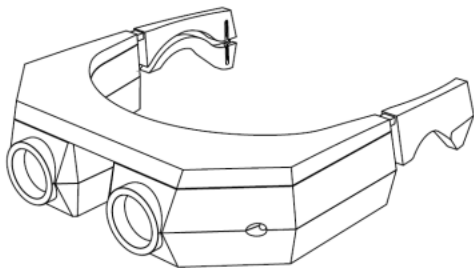

[11] 2016998.7M002

[15] 23-10-2020

[30] 24-04-2020 / CH, GB, EU / DM/208 144

[51] Cl. 16-06

[54] 具單鏡片的放大鏡

Magnifying glasses with single lens

- [73] Richemont International SA
Route des Biches 10,
1752 Villars-sur-Glâne,
Switzerland
- [74] UNION PATENT SERVICE CENTRE
Units E-F, 20th Floor, Neich Tower,
128 Gloucester Road,
Hong Kong

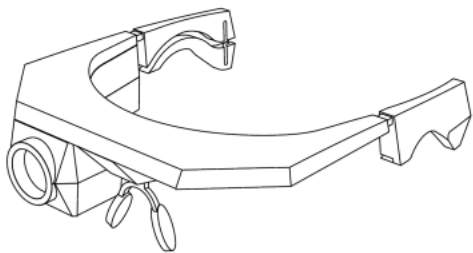

-
- [11] 2118308.8M001
- [15] 12-07-2021
- [51] Cl. 11-01
- [54] 飾物設計
Ornament design
- [73] 六福集團有限公司
Luk Fook Holdings Company Limited
Floor 15, 20, 25 & 27, Metropole Square,
No.2 On Yiu Street,
Shatin, New Territories, Hong Kong
- [74] Luk Fook Holdings Company Limited (Legal Affairs Department)
Floor 25, Metropole Square,
No.2 On Yiu Street,
Shatin, New Territories, Hong Kong



[11] 2118308.8M002

[15] 12-07-2021

[51] Cl. 11-01

[54] 飾物設計

Ornament design

[73] 六福集團有限公司

Luk Fook Holdings Company Limited

Floor 15, 20, 25 & 27, Metropole Square,

No.2 On Yiu Street,

Shatin, New Territories, Hong Kong

[74] Luk Fook Holdings Company Limited (Legal Affairs Department)

Floor 25, Metropole Square,

No.2 On Yiu Street,

Shatin, New Territories, Hong Kong



[11] 2118308.8M003

[15] 12-07-2021

[51] Cl. 11-01

[54] 飾物設計

Ornament design

[73] 六福集團有限公司

Luk Fook Holdings Company Limited

Floor 15, 20, 25 & 27, Metropole Square,

No.2 On Yiu Street,

Shatin, New Territories, Hong Kong

[74] Luk Fook Holdings Company Limited (Legal Affairs Department)

Floor 25, Metropole Square,

No.2 On Yiu Street,

Shatin, New Territories, Hong Kong

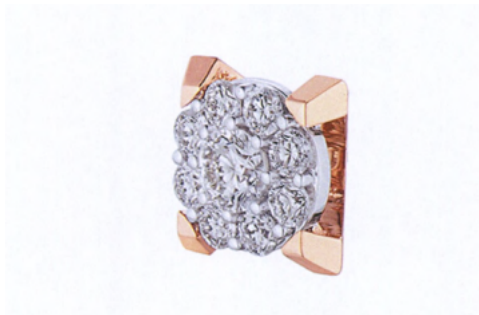

[11] 2118308.8M004

[15] 12-07-2021

[51] Cl. 11-01

[54] 飾物設計

Ornament design

[73] 六福集團有限公司

Luk Fook Holdings Company Limited

Floor 15, 20, 25 & 27, Metropole Square,

No.2 On Yiu Street,

Shatin, New Territories, Hong Kong

[74] Luk Fook Holdings Company Limited (Legal Affairs Department)

Floor 25, Metropole Square,

No.2 On Yiu Street,

Shatin, New Territories, Hong Kong



[11] 2118308.8M005

[15] 12-07-2021

[51] Cl. 11-01

[54] 飾物設計

Ornament design

[73] 六福集團有限公司

Luk Fook Holdings Company Limited

Floor 15, 20, 25 & 27, Metropole Square,

No.2 On Yiu Street,
Shatin, New Territories, Hong Kong

- [74] Luk Fook Holdings Company Limited (Legal Affairs Department)
Floor 25, Metropole Square,
No.2 On Yiu Street,
Shatin, New Territories, Hong Kong



[11] 2118308.8M006

[15] 12-07-2021

[51] Cl. 11-01

[54] 飾物設計
Ornament design

[73] 六福集團有限公司
Luk Fook Holdings Company Limited
Floor 15, 20, 25 & 27, Metropole Square,
No.2 On Yiu Street,
Shatin, New Territories, Hong Kong

[74] Luk Fook Holdings Company Limited (Legal Affairs Department)
Floor 25, Metropole Square,
No.2 On Yiu Street,
Shatin, New Territories, Hong Kong



[11] 2118308.8M007

[15] 12-07-2021

[51] Cl. 11-01

[54] 飾物設計

Ornament design

[73] 六福集團有限公司

Luk Fook Holdings Company Limited
Floor 15, 20, 25 & 27, Metropole Square,
No.2 On Yiu Street,
Shatin, New Territories, Hong Kong

[74] Luk Fook Holdings Company Limited (Legal Affairs Department)

Floor 25, Metropole Square,
No.2 On Yiu Street,
Shatin, New Territories, Hong Kong



[11] 2118308.8M008

[15] 12-07-2021

[51] Cl. 11-01

[54] 飾物設計

Ornament design

[73] 六福集團有限公司

Luk Fook Holdings Company Limited
Floor 15, 20, 25 & 27, Metropole Square,
No.2 On Yiu Street,
Shatin, New Territories, Hong Kong

[74] Luk Fook Holdings Company Limited (Legal Affairs Department)

Floor 25, Metropole Square,
No.2 On Yiu Street,
Shatin, New Territories, Hong Kong



[11] 2118308.8M009

[15] 12-07-2021

[51] Cl. 11-01

[54] 飾物設計

Ornament design

[73] 六福集團有限公司

Luk Fook Holdings Company Limited

Floor 15, 20, 25 & 27, Metropole Square,

No.2 On Yiu Street,

Shatin, New Territories, Hong Kong

[74] Luk Fook Holdings Company Limited (Legal Affairs Department)

Floor 25, Metropole Square,

No.2 On Yiu Street,

Shatin, New Territories, Hong Kong



[11] 2118308.8M010

[15] 12-07-2021

[51] Cl. 11-01

[54] 飾物設計

Ornament design

[73] 六福集團有限公司

Luk Fook Holdings Company Limited
Floor 15, 20, 25 & 27, Metropole Square,
No.2 On Yiu Street,
Shatin, New Territories, Hong Kong

[74] Luk Fook Holdings Company Limited (Legal Affairs Department)

Floor 25, Metropole Square,
No.2 On Yiu Street,
Shatin, New Territories, Hong Kong



[11] 2118308.8M011

[15] 12-07-2021

[51] Cl. 11-01

[54] 飾物設計

Ornament design

[73] 六福集團有限公司

Luk Fook Holdings Company Limited
Floor 15, 20, 25 & 27, Metropole Square,
No.2 On Yiu Street,
Shatin, New Territories, Hong Kong

[74] Luk Fook Holdings Company Limited (Legal Affairs Department)

Floor 25, Metropole Square,
No.2 On Yiu Street,
Shatin, New Territories, Hong Kong



[11] 2118308.8M012

[15] 12-07-2021

[51] Cl. 11-01

[54] 飾物設計

Ornament design

[73] 六福集團有限公司

Luk Fook Holdings Company Limited

Floor 15, 20, 25 & 27, Metropole Square,

No.2 On Yiu Street,

Shatin, New Territories, Hong Kong

[74] Luk Fook Holdings Company Limited (Legal Affairs Department)

Floor 25, Metropole Square,

No.2 On Yiu Street,

Shatin, New Territories, Hong Kong

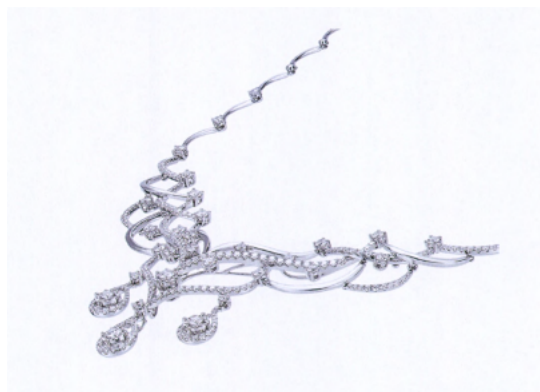

[11] 2118308.8M013

[15] 12-07-2021

[51] Cl. 11-01

[54] 飾物設計

Ornament design

[73] 六福集團有限公司

Luk Fook Holdings Company Limited

Floor 15, 20, 25 & 27, Metropole Square,

No.2 On Yiu Street,

Shatin, New Territories, Hong Kong

[74] Luk Fook Holdings Company Limited (Legal Affairs Department)

Floor 25, Metropole Square,

No.2 On Yiu Street,

Shatin, New Territories, Hong Kong



[11] 2118308.8M014

[15] 12-07-2021

[51] Cl. 11-01

[54] 飾物設計

Ornament design

[73] 六福集團有限公司

Luk Fook Holdings Company Limited
Floor 15, 20, 25 & 27, Metropole Square,
No.2 On Yiu Street,
Shatin, New Territories, Hong Kong

[74] Luk Fook Holdings Company Limited (Legal Affairs Department)

Floor 25, Metropole Square,
No.2 On Yiu Street,
Shatin, New Territories, Hong Kong



[11] 2118308.8M015

[15] 12-07-2021

[51] Cl. 11-01

[54] 飾物設計

Ornament design

[73] 六福集團有限公司

Luk Fook Holdings Company Limited
Floor 15, 20, 25 & 27, Metropole Square,
No.2 On Yiu Street,
Shatin, New Territories, Hong Kong

[74] Luk Fook Holdings Company Limited (Legal Affairs Department)

Floor 25, Metropole Square,
No.2 On Yiu Street,
Shatin, New Territories, Hong Kong



[11] 2118308.8M016

[15] 12-07-2021

[51] Cl. 11-01

[54] 飾物設計

Ornament design

[73] 六福集團有限公司

Luk Fook Holdings Company Limited
Floor 15, 20, 25 & 27, Metropole Square,
No.2 On Yiu Street,
Shatin, New Territories, Hong Kong

[74] Luk Fook Holdings Company Limited (Legal Affairs Department)

Floor 25, Metropole Square,
No.2 On Yiu Street,
Shatin, New Territories, Hong Kong



[11] 2118308.8M017

[15] 12-07-2021

[51] Cl. 11-01

[54] 飾物設計

Ornament design

[73] 六福集團有限公司

Luk Fook Holdings Company Limited
Floor 15, 20, 25 & 27, Metropole Square,
No.2 On Yiu Street,
Shatin, New Territories, Hong Kong

[74] Luk Fook Holdings Company Limited (Legal Affairs Department)

Floor 25, Metropole Square,
No.2 On Yiu Street,
Shatin, New Territories, Hong Kong



[11] 2118308.8M018

[15] 12-07-2021

[51] Cl. 11-01

[54] 飾物設計

Ornament design

[73] 六福集團有限公司

Luk Fook Holdings Company Limited
Floor 15, 20, 25 & 27, Metropole Square,

No.2 On Yiu Street,
Shatin, New Territories, Hong Kong

- [74] Luk Fook Holdings Company Limited (Legal Affairs Department)
Floor 25, Metropole Square,
No.2 On Yiu Street,
Shatin, New Territories, Hong Kong



[11] 2118308.8M019

[15] 12-07-2021

[51] Cl. 11-01

[54] 飾物設計

Ornament design

[73] 六福集團有限公司

Luk Fook Holdings Company Limited
Floor 15, 20, 25 & 27, Metropole Square,
No.2 On Yiu Street,
Shatin, New Territories, Hong Kong

- [74] Luk Fook Holdings Company Limited (Legal Affairs Department)
Floor 25, Metropole Square,
No.2 On Yiu Street,
Shatin, New Territories, Hong Kong



[11] 2118313.8M001

[15] 12-07-2021

[51] Cl. 11-03

[54] 別針 (徽章)
Pin (badge)

[73] WONG, Ka Wai
38G, Tower 1, Residence Oasis,
15 Pui Shing Road,
Hang Hau, Tseung Kwan O,
New Territories, Hong Kong

[74] IMARKET IP LIMITED
Rm 1008, Prosperity Millennia Plaza,
663 King's Road,
Quarry Bay, Hong Kong



[11] 2118313.8M002

[15] 12-07-2021

[51] Cl. 11-03

[54] 別針 (徽章)
Pin (badge)

[73] WONG, Ka Wai
38G, Tower 1, Residence Oasis,
15 Pui Shing Road,
Hang Hau, Tseung Kwan O,
New Territories, Hong Kong

[74] IMARKET IP LIMITED
Rm 1008, Prosperity Millennia Plaza,
663 King's Road,
Quarry Bay, Hong Kong



[11] 2118313.8M003

[15] 12-07-2021

[51] Cl. 11-03

[54] 別針 (徽章)

Pin (badge)

[73] WONG, Ka Wai

38G, Tower 1, Residence Oasis,

15 Pui Shing Road,

Hang Hau, Tseung Kwan O,

New Territories, Hong Kong

[74] IMARKET IP LIMITED

Rm 1008, Prosperity Millennia Plaza,

663 King's Road,

Quarry Bay, Hong Kong



[11] 2118313.8M004

[15] 12-07-2021

[51] Cl. 11-03

[54] 別針 (徽章)

Pin (badge)

[73] WONG, Ka Wai

38G, Tower 1, Residence Oasis,

15 Pui Shing Road,

Hang Hau, Tseung Kwan O,

New Territories, Hong Kong

[74] IMARKET IP LIMITED

Rm 1008, Prosperity Millennia Plaza,

663 King's Road,

Quarry Bay, Hong Kong



[11] 2118313.8M005

[15] 12-07-2021

[51] Cl. 11-03

[54] 別針 (徽章)

Pin (badge)

[73] WONG, Ka Wai

38G, Tower 1, Residence Oasis,

15 Pui Shing Road,

Hang Hau, Tseung Kwan O,

New Territories, Hong Kong

[74] IMARKET IP LIMITED

Rm 1008, Prosperity Millennia Plaza,

663 King's Road,

Quarry Bay, Hong Kong



[11] 2118313.8M006

[15] 12-07-2021

[51] Cl. 11-03

[54] 別針 (徽章)

Pin (badge)

[73] WONG, Ka Wai

38G, Tower 1, Residence Oasis,

15 Pui Shing Road,

Hang Hau, Tseung Kwan O,
New Territories, Hong Kong

- [74] IMARKET IP LIMITED
Rm 1008, Prosperity Millennia Plaza,
663 King's Road,
Quarry Bay, Hong Kong



-
- [11] 2118313.8M007
[15] 12-07-2021
[51] Cl. 11-03
[54] 別針 (徽章)
Pin (badge)
[73] WONG, Ka Wai
38G, Tower 1, Residence Oasis,
15 Pui Shing Road,
Hang Hau, Tseung Kwan O,
New Territories, Hong Kong
[74] IMARKET IP LIMITED
Rm 1008, Prosperity Millennia Plaza,
663 King's Road,
Quarry Bay, Hong Kong



-
- [11] 2118321.5M001
[15] 13-07-2021

[30] 15-01-2021 / LI, MC, OM, RU, SG, CH, TR, UA, GB, VN, EU, IS,
JP, KR / WIPO101002

[51] Cl. 10-02

[54] 手錶
Watch

[73] Turlen Holding SA
Rue du Jura 11,
2345 Les Breuleux,
Switzerland

[74] WILKINSON & GRIST
6th Floor, Prince's Building,
Chater Road,
Hong Kong

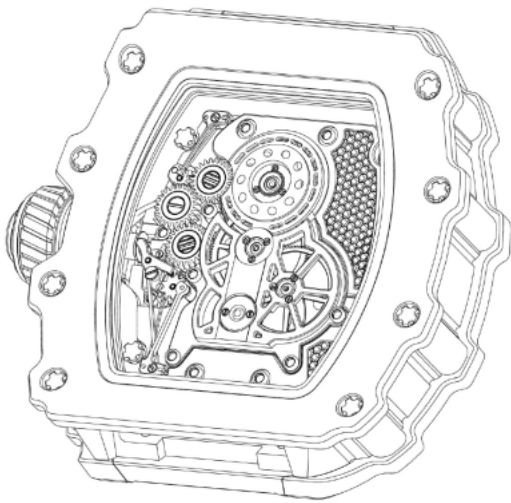

[11] 2118321.5M002

[15] 13-07-2021

[30] 15-01-2021 / LI, MC, OM, RU, SG, CH, TR, UA, GB, VN, EU, IS,
JP, KR / WIPO101002

[51] Cl. 10-07

[54] 錶殼
Watch case

[73] Turlen Holding SA
Rue du Jura 11,
2345 Les Breuleux,
Switzerland

[74] WILKINSON & GRIST
6th Floor, Prince's Building,
Chater Road,
Hong Kong

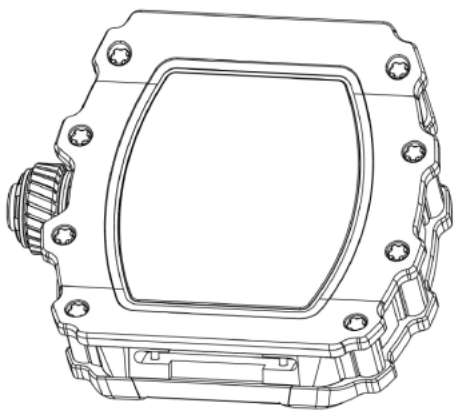

[11] 2118323.9M001

[15] 13-07-2021

[30] 18-01-2021 / EU / 008405849-0001

[51] Cl. 2-04

[54] 鞋

Shoes

[73] BOTTEGA VENETA S.R.L.

Località Conti Maltraverso 1,
36054 Montebello Vicentino (VI),
Italy

[74] ELLALAN

26th and 28th Floors, The Hennessy,
256 Hennessy Road,
Wanchai, Hong Kong



[11] 2118323.9M002

- [15] 13-07-2021
- [30] 18-01-2021 / EU / 008405849-0005
- [51] Cl. 2-04
- [54] 鞋
Shoes
- [73] BOTTEGA VENETA S.R.L.
Località Conti Maltraverso 1,
36054 Montebello Vicentino (VI),
Italy
- [74] ELLALAN
26th and 28th Floors, The Hennessy,
256 Hennessy Road,
Wanchai, Hong Kong



-
- [11] 2118324.1M001
- [15] 13-07-2021
- [30] 01-03-2021 / CA, AM, AZ, BZ, BA, GE, LI, MK, MD, MC, MN, ME,
MA, NO, OM, SG, CH, TN, TR, UA, GB, EU, AL, KG / DM/213 344
- [51] Cl. 11-01
- [54] 指環
Ring
- [73] Harry Winston SA
Chemin du Tourbillon 8,
CH-1228 Plan-les-Ouates,
Switzerland
- [74] SPRUSON & FERGUSON (HONG KONG) LIMITED
5001 Hopewell Centre,
183 Queen's Road East,
Wan Chai, Hong Kong



[11] 2118324.1M002

[15] 13-07-2021

[30] 01-03-2021 / CA, AM, AZ, BZ, BA, GE, LI, MK, MD, MC, MN, ME, MA, NO, OM, SG, CH, TN, TR, UA, GB, EU, AL, KG / DM/213 344

[51] Cl. 11-01

[54] 指環
Ring

[73] Harry Winston SA
Chemin du Tourbillon 8,
CH-1228 Plan-les-Ouates,
Switzerland

[74] SPRUSON & FERGUSON (HONG KONG) LIMITED
5001 Hopewell Centre,
183 Queen's Road East,
Wan Chai, Hong Kong



[11] 2118324.1M003

[15] 13-07-2021

[30] 01-03-2021 / CA, AM, AZ, BZ, BA, GE, LI, MK, MD, MC, MN, ME, MA, NO, OM, SG, CH, TN, TR, UA, GB, EU, AL, KG / DM/213 344

[51] Cl. 11-01

[54] 項鍊

Necklace

[73] Harry Winston SA

Chemin du Tourbillon 8,
CH-1228 Plan-les-Ouates,
Switzerland

[74] SPRUSON & FERGUSON (HONG KONG) LIMITED

5001 Hopewell Centre,
183 Queen's Road East,
Wan Chai, Hong Kong



[11] 2118324.1M004

[15] 13-07-2021

[30] 01-03-2021 / CA, AM, AZ, BZ, BA, GE, LI, MK, MD, MC, MN, ME, MA, NO, OM, SG, CH, TN, TR, UA, GB, EU, AL, KG / DM/213 344

[51] Cl. 11-01

[54] 耳環

Earrings

[73] Harry Winston SA

Chemin du Tourbillon 8,
CH-1228 Plan-les-Ouates,
Switzerland

[74] SPRUSON & FERGUSON (HONG KONG) LIMITED

5001 Hopewell Centre,
183 Queen's Road East,
Wan Chai, Hong Kong



[11] 2118324.1M005

[15] 13-07-2021

[30] 01-03-2021 / CA, AM, AZ, BZ, BA, GE, LI, MK, MD, MC, MN, ME, MA, NO, OM, SG, CH, TN, TR, UA, GB, EU, AL, KG / DM/213 344

[51] Cl. 11-01

[54] 耳環

Earrings

[73] Harry Winston SA

Chemin du Tourbillon 8,
CH-1228 Plan-les-Ouates,
Switzerland

[74] SPRUSON & FERGUSON (HONG KONG) LIMITED

5001 Hopewell Centre,
183 Queen's Road East,
Wan Chai, Hong Kong

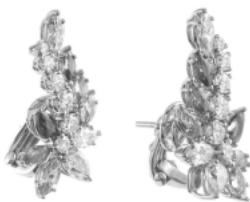

[11] 2118324.1M006

[15] 13-07-2021

[30] 01-03-2021 / CA, AM, AZ, BZ, BA, GE, LI, MK, MD, MC, MN, ME, MA, NO, OM, SG, CH, TN, TR, UA, GB, EU, AL, KG / DM/213 344

[51] Cl. 11-01

[54] 耳環

Earrings

[73] Harry Winston SA

Chemin du Tourbillon 8,

CH-1228 Plan-les-Ouates,
Switzerland

- [74] SPRUSON & FERGUSON (HONG KONG) LIMITED
5001 Hopewell Centre,
183 Queen's Road East,
Wan Chai, Hong Kong

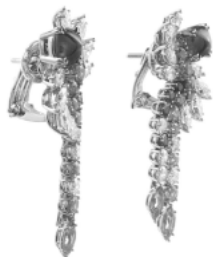

[11] 2118324.1M007

[15] 13-07-2021

[30] 01-03-2021 / CA, AM, AZ, BZ, BA, GE, LI, MK, MD, MC, MN, ME,
MA, NO, OM, SG, CH, TN, TR, UA, GB, EU, AL, KG / DM/213 344

[51] Cl. 11-01

[54] 耳環

Earrings

[73] Harry Winston SA

Chemin du Tourbillon 8,
CH-1228 Plan-les-Ouates,
Switzerland

- [74] SPRUSON & FERGUSON (HONG KONG) LIMITED
5001 Hopewell Centre,
183 Queen's Road East,
Wan Chai, Hong Kong

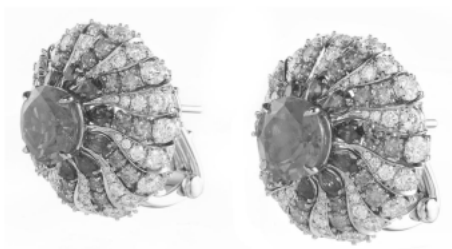

[11] 2118324.1M008

[15] 13-07-2021

[30] 01-03-2021 / CA, AM, AZ, BZ, BA, GE, LI, MK, MD, MC, MN, ME, MA, NO, OM, SG, CH, TN, TR, UA, GB, EU, AL, KG / DM/213 344

[51] Cl. 11-01

[54] 耳環

Earrings

[73] Harry Winston SA

Chemin du Tourbillon 8,
CH-1228 Plan-les-Ouates,
Switzerland

[74] SPRUSON & FERGUSON (HONG KONG) LIMITED

5001 Hopewell Centre,
183 Queen's Road East,
Wan Chai, Hong Kong

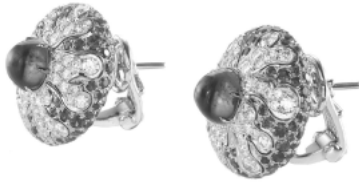

[11] 2118324.1M009

[15] 13-07-2021

[30] 01-03-2021 / CA, AM, AZ, BZ, BA, GE, LI, MK, MD, MC, MN, ME, MA, NO, OM, SG, CH, TN, TR, UA, GB, EU, AL, KG / DM/213 344

[51] Cl. 11-01

[54] 手鐲

Bracelet

[73] Harry Winston SA

Chemin du Tourbillon 8,
CH-1228 Plan-les-Ouates,
Switzerland

[74] SPRUSON & FERGUSON (HONG KONG) LIMITED

5001 Hopewell Centre,
183 Queen's Road East,
Wan Chai, Hong Kong



[11] 2118324.1M010

[15] 13-07-2021

[30] 01-03-2021 / CA, AM, AZ, BZ, BA, GE, LI, MK, MD, MC, MN, ME,
MA, NO, OM, SG, CH, TN, TR, UA, GB, EU, AL, KG / DM/213 344

[51] Cl. 11-01

[54] 項鍊

Necklace

[73] Harry Winston SA

Chemin du Tourbillon 8,
CH-1228 Plan-les-Ouates,
Switzerland

[74] SPRUSON & FERGUSON (HONG KONG) LIMITED

5001 Hopewell Centre,
183 Queen's Road East,
Wan Chai, Hong Kong



[11] 2118324.1M011

[15] 13-07-2021

[30] 01-03-2021 / CA, AM, AZ, BZ, BA, GE, LI, MK, MD, MC, MN, ME,
MA, NO, OM, SG, CH, TN, TR, UA, GB, EU, AL, KG / DM/213 344

[51] Cl. 11-01

[54] 耳環

Earrings

[73] Harry Winston SA

Chemin du Tourbillon 8,

CH-1228 Plan-les-Ouates,
Switzerland

- [74] SPRUSON & FERGUSON (HONG KONG) LIMITED
5001 Hopewell Centre,
183 Queen's Road East,
Wan Chai, Hong Kong



[11] 2118325.4

[15] 13-07-2021

[51] Cl. 23-04

[54] 空氣淨化器
Air purifier

[73] 蔡龍威
CHOI, Lung Wai
Unit 501-502, 5/F., Lu Plaza,
2 Wing Yip Street,
Kwun Tong, Kowloon, Hong Kong

[74] BARRON & YOUNG INTELLECTUAL PROPERTY LIMITED
Suite 617, Lakeside 2,
No. 10 Science Park West Avenue,
Hong Kong Science Park, Shatin, N.T., Hong Kong

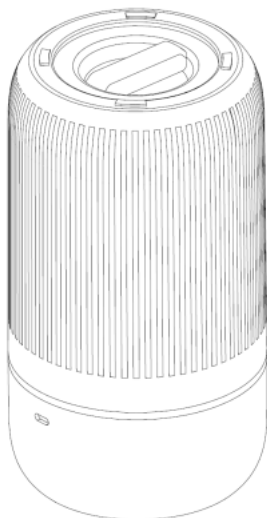

- [11] 2118326.6
[15] 14-07-2021
[51] Cl. 6-09
[54] 枕頭結構
Structure for pillow
[73] ABLUE Co., Ltd.
(15850) 56, Bongseong-ro,
Gunpo-si, Gyeonggi-do,
Korea, Republic of
[74] CHLOE LEE & CO.
1104 Tai Tung Building,
8 Fleming Road,
Wanchai, Hong Kong

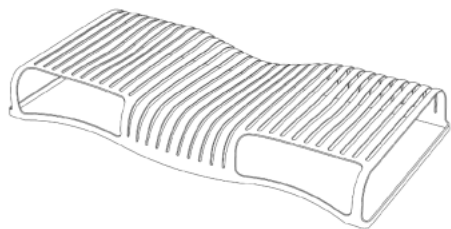

-
- [11] 2118327.8
[15] 14-07-2021
[30] 21-01-2021 / CN / 202130044232.8
[51] Cl. 14-03
[54] 手機
Mobile phone
[73] VIVO MOBILE COMMUNICATION CO., LTD.
維沃移動通信有限公司
中國內地
廣東省東莞市長安鎮
靖海東路 168 號
[74] 中國專利代理(香港)有限公司
香港灣仔
港灣道 23 號
鷹君中心 22 字樓



[11] 2118328.0

[15] 14-07-2021

[51] Cl. 6-02

[54] 床
Bed

[73] 溢匯企業有限公司
HARVEST TEAM ENTERPRISE LIMITED
香港九龍
紅磡民裕街 30 號
興業工商大廈 6 樓 L2 室

[74] HARVEST TEAM ENTERPRISE LIMITED
香港九龍
民裕街 30 號
興業工商大廈 6 樓 L2 室



[11] 2118329.2

[15] 14-07-2021

[51] Cl. 3-01

[54] 袋
Bag

[73] 媽咪雞蛋仔有限公司
Mammy Pancake Company Limited
香港九龍
紅磡鶴園東街 1 號
富恆工業大廈 5 樓 513 室

[74] 卓遠知識產權有限公司
香港上環
禧利街 27 號
富輝商業中心 10 樓



[11] 2118330.4

[15] 14-07-2021

[51] Cl. 3-01

[54] 招財貓匙扣
Lucky cat keychain

[73] 廖振恒
香港柴灣
杏花村
18 座 1903 室

[74] 廖振恒
香港柴灣
杏花村
18 座 1903 室



[11] 2118331.6

[15] 14-07-2021

[30] 16-06-2021 / KR / 30-2021-0028694

[51] Cl. 29-02

[54] 口罩
Mask

[73] SG 生活安全股份公司
SG SAFETY CORPORATION
28, Sinpyeong-ro (Yucheon-dong),
Pyeongtaek-si, Gyeonggi-do 17878,
Korea, Republic of

[74] BIRD & BIRD
6/F, The Annex, Central Plaza,
18 Harbour Road,
Hong Kong



[11] 2118332.8

[15] 14-07-2021

[51] Cl. 6-01

- [54] 沙發
Sofa
- [73] Chainiti Furniture Co., Limited
香港九龍
油麻地碧街 38 號
協群商業大廈 21 樓 02 室
- [74] 中港知識產權有限公司
香港
灣仔告士打道 151 號
資本中心 15 樓 1502 室
HONG KONG

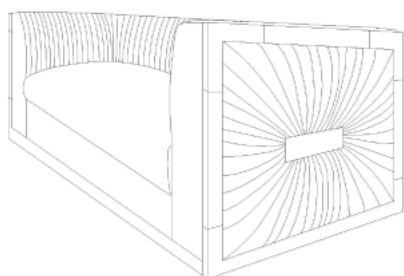

-
- [11] 2118339.3
- [15] 15-07-2021
- [30] 20-01-2021 / CN / 202130041121.1
- [51] Cl. 14-06
- [54] 無線充電支架
Wireless charging holder
- [73] 廣東高普達集團股份有限公司
GUANGDONG GOPOD GROUP HOLDING CO., LTD
中國內地
廣東省深圳市龍華新區大浪街道同勝社區華榮路
聯建科技工業園廠房 8 棟 4,5,6 樓
- [74] 中一聯合國際知識產權有限公司
香港九龍
尖沙咀漆咸道南 45-51 號
其士大廈 803 室

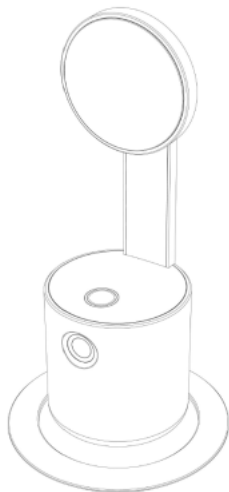

[11] 2118340.5

[15] 15-07-2021

[30] 20-01-2021 / CN / 202130041112.2

[51] Cl. 14-06

[54] 無線充電支架

Wireless charging holder

[73] 廣東高普達集團股份有限公司

GUANGDONG GOPOD GROUP HOLDING CO., LTD

中國內地

廣東省深圳市龍華新區大浪街道同勝社區華榮路

聯建科技工業園廠房 8 棟 4,5,6 樓

[74] 中一聯合國際知識產權有限公司

香港九龍

尖沙咀漆咸道南 45-51 號

其士大廈 803 室

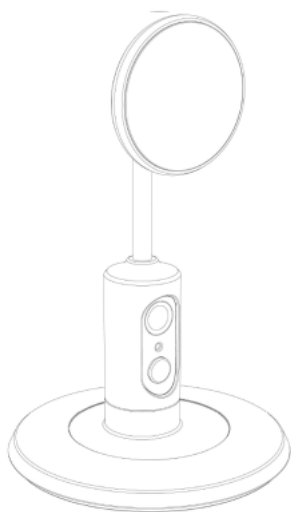

- [11] 2118348.2
[15] 19-07-2021
[30] 28-04-2021 / MA, NO, OM, SG, CH, TN, TR, UA, GB, EU, AL /
DM/214 082
[51] Cl. 10-02
[54] 手錶
Wristwatch
[73] SWATCH AG (SWATCH SA) (SWATCH LTD.)
Nicolas G. Hayek Strasse 1,
2502 Biel/Bienne,
Switzerland
[74] SPRUSON & FERGUSON (HONG KONG) LIMITED
5001 Hopewell Centre,
183 Queen's Road East,
Wan Chai, Hong Kong



-
- [11] 2118349.4
[15] 19-07-2021
[30] 03-05-2021 / MA, NO, OM, SG, CH, TN, TR, UA, GB, EU, AL /
DM/214 219
[51] Cl. 10-02
[54] 手錶
Wristwatch
[73] SWATCH AG (SWATCH SA) (SWATCH LTD.)
Nicolas G. Hayek Strasse 1,
2502 Biel/Bienne,
Switzerland
[74] SPRUSON & FERGUSON (HONG KONG) LIMITED
5001 Hopewell Centre,
183 Queen's Road East,
Wan Chai, Hong Kong



[11] 2118351.8

[15] 20-07-2021

[51] Cl. 14-03

[54] 網絡對講機

Network walkie talkie

[73] 普思電訊有限公司

CPS Telecom Limited

Office B, 15/Fl., King Palace Plaza,

55 King Yip Street,

Kwun Tong, Kowloon, Hong Kong

[74] CPS Telecom Limited

Office B, 15/Fl., King Palace, Plaza,

55 King Yip Street,

Kwun Tong, Kowloon, Hong Kong

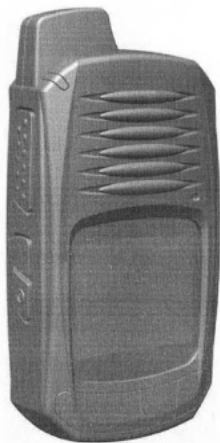

[11] 2118352.0

[15] 19-07-2021

[51] Cl. 9-03

[54] 包裝盒

Packing box

[73] MI HK BIO-ENGINEERING LIMITED
香港九龍
長沙灣長裕街 12 號
經達廣場 1101 室

[74] MI HK BIO-ENGINEERING LIMITED
香港九龍
長沙灣長裕街 12 號
經達廣場 1101 室

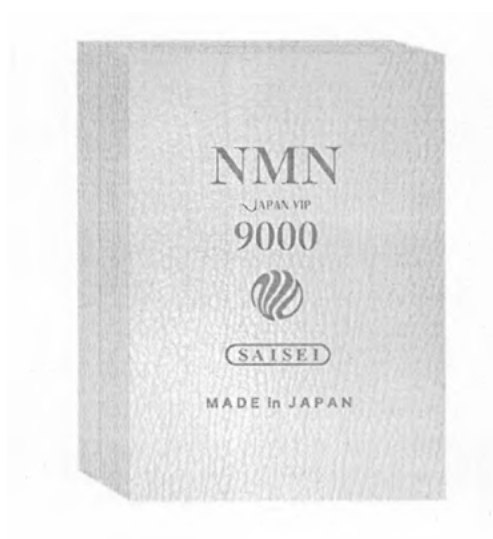

[11] 2118353.2

[15] 20-07-2021

[30] 27-05-2021 / CN / 202130320543.2

[51] Cl. 14-03

[54] 手機
Mobile phone

[73] 維沃移動通信有限公司
VIVO MOBILE COMMUNICATION CO., LTD.
中國內地
廣東省東莞市長安鎮
靖海東路 168 號

[74] 中國專利代理(香港)有限公司
香港灣仔
港灣道 23 號
鷹君中心 22 字樓



[11] 2118354.4

[15] 20-07-2021

[51] Cl. 9-03

[54] 自動販賣機所銷售商品的包裝盒

Container for product packaging for selling in a vending machine

[73] I Love You Inc.

1810 E Sahara Ave Ste 215,

Las Vegas, NV 89104,

United States of America

[74] I Love You Limited

Unit 1, 11/F, Wing Sum Factory Building No. 2,

12-14 Sam Chuk Street,

San Po Kong, Kowloon, Hong Kong



[11] 2118357.1

[15] 20-07-2021

[30] 28-05-2021 / JP / 011477 of 2021

[51] Cl. 7-01

[54] 馬克杯

Mug

- [73] 長澤愛子
Aiko Nagasawa
D803, 11-2, 1-chome, Numakage, Minami-ku,
Saitama-shi, Saitama,
Japan
- [74] MARKS & CLERK
Level 9, Cyberport 1,
100 Cyberport Road,
Pok Fu Lam, Hong Kong



-
- [11] 2118358.3
- [15] 20-07-2021
- [30] 24-06-2021 / CN / 202130394588.4
- [51] Cl. 9-05
- [54] 包裝桶
Packaging tub
- [73] 威萊（香港）有限公司
WHEALTHFIELDS (HONG KONG) LIMITED
香港新界
沙田安耀街 3 號
匯達大廈 2606-10 室
- [74] 精英知識產權服務有限公司
香港九龍
彌敦道 695 號
永如大廈 12 字樓

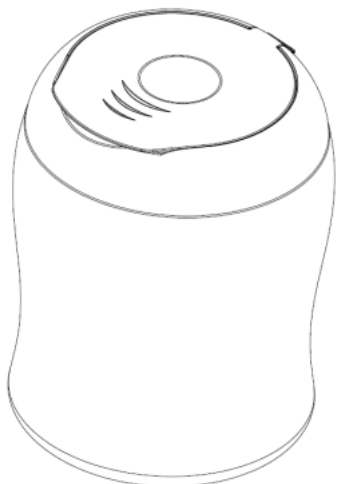

[11] 2118359.5

[15] 20-07-2021

[30] 24-06-2021 / CN / 202130394579.5

[51] Cl. 9-01

[54] 包裝瓶

Packaging bottle

[73] 威萊（香港）有限公司

WHEALTHFIELDS (HONG KONG) LIMITED

香港新界

沙田安耀街 3 號

匯達大廈 2606-10 室

[74] 精英知識產權服務有限公司

香港九龍

彌敦道 695 號

永如大廈 12 字樓

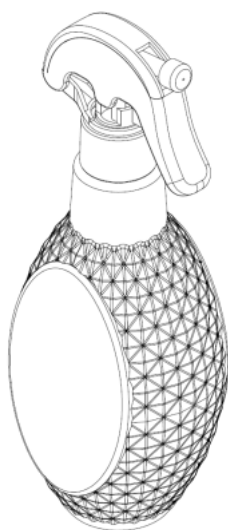

- [11] 2118360.7
[15] 20-07-2021
[30] 24-06-2021 / CN / 202130394329.1
[51] Cl. 9-01
[54] 包裝瓶
Packaging bottle
[73] 威萊（香港）有限公司
WHEALTHFIELDS (HONG KONG) LIMITED
香港新界
沙田安耀街 3 號
匯達大廈 2606-10 室
[74] 精英知識產權服務有限公司
香港九龍
彌敦道 695 號
永如大廈 12 字樓

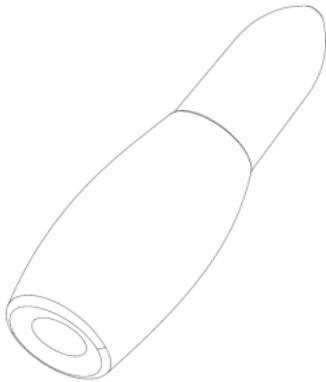

-
- [11] 2118362.1
[15] 21-07-2021
[30] 29-01-2021 / AM, AZ, BZ, BA, GE, LI, MK, MD, MC, MN, ME, MA,
NO, OM, RU, SG, CH, TN, TR, UA, GB, EU, AL, KG / DM/212 688
[51] Cl. 10-02
[54] 錶
Watch
[73] OMEGA SA (OMEGA AG) (OMEGA LTD.)
Jakob-Stämpfli-Strasse 96,
CH-2502 Biel/Bienne,
Switzerland
[74] SPRUSON & FERGUSON (HONG KONG) LIMITED
5001 Hopewell Centre,
183 Queen's Road East,
Wan Chai, Hong Kong

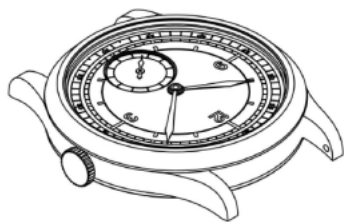

[11] 2118363.3M001

[15] 21-07-2021

[30] 22-01-2021 / CA, EG, MX, MC, MA, NO, RU, SG, CH, TN, TR, UA,
GB, US, VN, EU, JP, KR / DM/212 445

[51] Cl. 3-01

[54] 行李袋

Travelling bag

[73] HERMES SELLIER

24, Rue du Faubourg Saint-Honoré,

75008 Paris,

France

[74] DEACONS

5th Floor, Alexandra House,

Central,

Hong Kong



[11] 2118363.3M002

[15] 21-07-2021

[30] 22-01-2021 / CA, EG, MX, MC, MA, NO, RU, SG, CH, TN, TR, UA,
GB, US, VN, EU, JP, KR / DM/212 424

[51] Cl. 3-01

[54] 袋
Bag

[73] HERMES SELLIER
24, Rue du Faubourg Saint-Honoré,
75008 Paris,
France

[74] DEACONS
5th Floor, Alexandra House,
Central,
Hong Kong



[11] 2118363.3M003

[15] 21-07-2021

[30] 04-03-2021 / CA, EG, MX, MC, MA, NO, RU, SG, CH, TN, TR, UA,
GB, US, VN, EU, JP, KR / DM/213 039

[51] Cl. 3-01

[54] 手袋
Handbag

[73] HERMES SELLIER
24, Rue du Faubourg Saint-Honoré,
75008 Paris,
France

[74] DEACONS
5th Floor, Alexandra House,
Central,
Hong Kong



[11] 2118363.3M004

[15] 21-07-2021

[30] 04-03-2021 / CA, EG, MX, MC, MA, NO, RU, SG, CH, TN, TR, UA,
GB, US, VN, EU, JP, KR / DM/213 038

[51] Cl. 3-01

[54] 手提包

Clutch bag

[73] HERMES SELLIER

24, Rue du Faubourg Saint-Honoré,

75008 Paris,

France

[74] DEACONS

5th Floor, Alexandra House,

Central,

Hong Kong



[11] 2118363.3M005

[15] 21-07-2021

[30] 10-03-2021 / CA, EG, MX, MC, MA, NO, RU, SG, CH, TN, TR, UA,
GB, US, EU, JP, KR / DM/213 203

[51] Cl. 3-01

[54] 袋
Bag

[73] HERMES SELLIER
24, Rue du Faubourg Saint-Honoré,
75008 Paris,
France

[74] DEACONS
5th Floor, Alexandra House,
Central,
Hong Kong



[11] 2118363.3M006

[15] 21-07-2021

[30] 10-03-2021 / VN / DM/213 257

[51] Cl. 3-01

[54] 袋
Bag

[73] HERMES SELLIER
24, Rue du Faubourg Saint-Honoré,
75008 Paris,
France

[74] DEACONS
5th Floor, Alexandra House,
Central,
Hong Kong



[11] 2118363.3M007

[15] 21-07-2021

[30] 10-03-2021 / CA, EG, MX, MC, MA, NO, RU, SG, CH, TN, TR, UA,
GB, US, VN, EU, JP, KR / DM/213 175

[51] Cl. 3-01

[54] 袋

Bag

[73] HERMES SELLIER

24, Rue du Faubourg Saint-Honoré,

75008 Paris,

France

[74] DEACONS

5th Floor, Alexandra House,

Central,

Hong Kong



[11] 2118363.3M008

[15] 21-07-2021

[30] 10-03-2021 / CA, EG, MX, MC, MA, NO, RU, SG, CH, TN, TR, UA,
GB, US, VN, EU, JP, KR / DM/213 177

[51] Cl. 3-01

[54] 袋

Bag

[73] HERMES SELLIER

24, Rue du Faubourg Saint-Honoré,

75008 Paris,

France

[74] DEACONS

5th Floor, Alexandra House,

Central,

Hong Kong



[11] 2118363.3M009

[15] 21-07-2021

[30] 11-03-2021 / CA, EG, MX, MC, MA, NO, RU, SG, CH, TN, TR, UA,
GB, US, VN, EU, JP, KR / DM/213 195

[51] Cl. 3-01

[54] 手提箱用地址牌

Address holder for suitcase

[73] HERMES SELLIER

24, Rue du Faubourg Saint-Honoré,

75008 Paris,

France

[74] DEACONS

5th Floor, Alexandra House,

Central,

Hong Kong



[11] 2118365.8

[15] 21-07-2021

[51] Cl. 11-01

[54] 貴金屬耳扣

Precious metal ear-nut

[73] 廣州市天豐珠寶有限公司
Guangzhou TinFung Jewelry Limited
中國內地
廣東省廣州市番禺區
沙頭街銀建路 34 號二樓

[74] 衛好知識產權有限公司
香港
木星街 9 號
永昇中心 2002

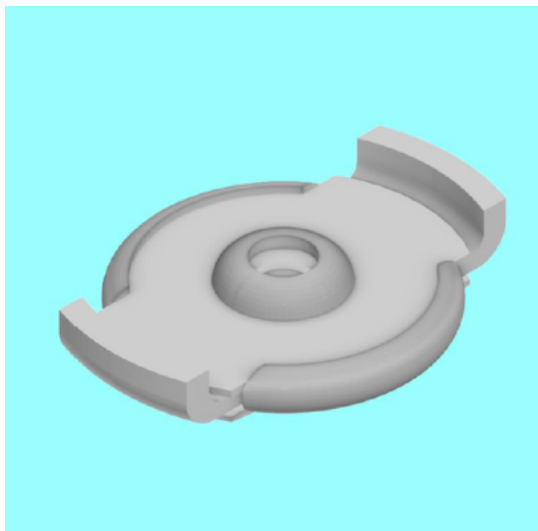

[11] 2118368.4M001

[15] 21-07-2021

[30] 22-01-2021 / IT / 402021000000137

[51] Cl. 2-04

[54] 鞋
Shoe

[73] VALENTINO S.p.A.
Via Turati, 16/18,
I-20121 Milano,
Italy

[74] BARRON & YOUNG INTELLECTUAL PROPERTY LIMITED
Suite 617, Lakeside 2,
No. 10 Science Park West Avenue,
Hong Kong Science Park, Shatin, N.T., Hong Kong



[11] 2118368.4M002

[15] 21-07-2021

[30] 22-01-2021 / IT / 402021000000137

[51] Cl. 2-04

[54] 鞋
Shoe

[73] VALENTINO S.p.A.
Via Turati, 16/18,
I-20121 Milano,
Italy

[74] BARRON & YOUNG INTELLECTUAL PROPERTY LIMITED
Suite 617, Lakeside 2,
No. 10 Science Park West Avenue,
Hong Kong Science Park, Shatin, N.T., Hong Kong

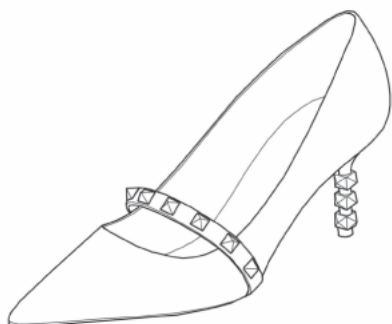

[11] 2118369.6

[15] 22-07-2021

[30] 10-06-2021 / CN / 202130360681.3

- [51] Cl. 9-01
- [54] 化妝品包裝瓶
Cosmetic packaging bottle
- [73] 杭州伸美品牌管理有限公司
中國內地
浙江省杭州市河莊街道
青西二路 1099 號綜合樓 602-36 號
- [74] CHINA PATENT AGENT (HONG KONG) LIMITED
22/F, Great Eagle Centre,
23 Harbour Road,
Wanchai, Hong Kong

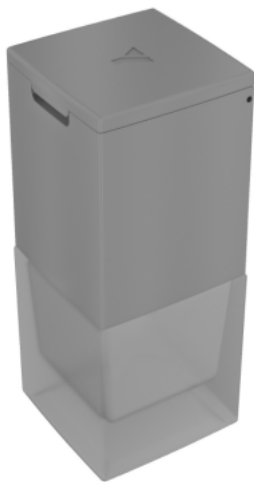

-
- [11] 2118370.8M001
- [15] 22-07-2021
- [30] 01-06-2021 / JP / 011641 of 2021
- [51] Cl. 11-01
- [54] 耳環
Earring
- [73] TASAKI & Co., Ltd.
3-2, 6-chome, Minatojima Naka-machi,
Chuo-ku, Kobe 650-0046,
Japan
- [74] DEACONS
5th Floor, Alexandra House,
Central,
Hong Kong

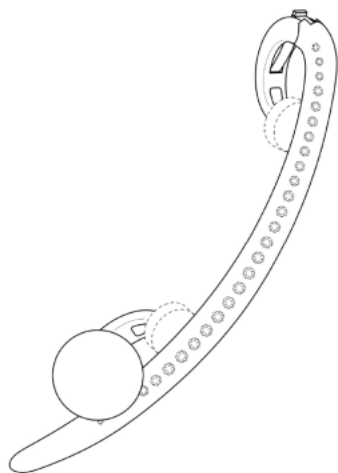

[11] 2118370.8M002

[15] 22-07-2021

[30] 01-06-2021 / JP / 011642 of 2021

[51] Cl. 11-01

[54] 耳環

Earring

[73] TASAKI & Co., Ltd.

3-2, 6-chome, Minatojima Naka-machi,
Chuo-ku, Kobe 650-0046,
Japan

[74] DEACONS

5th Floor, Alexandra House,
Central,
Hong Kong

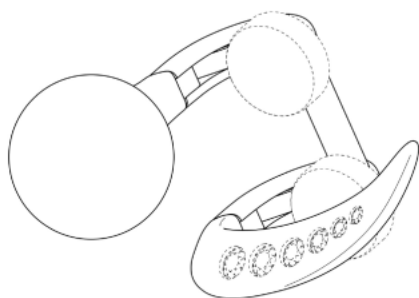

[11] 2118370.8M003

[15] 22-07-2021

[30] 01-06-2021 / JP / 011643 of 2021

[51] Cl. 11-01

[54] 耳環

Earring

[73] TASAKI & Co., Ltd.
3-2, 6-chome, Minatojima Naka-machi,
Chuo-ku, Kobe 650-0046,
Japan

[74] DEACONS
5th Floor, Alexandra House,
Central,
Hong Kong

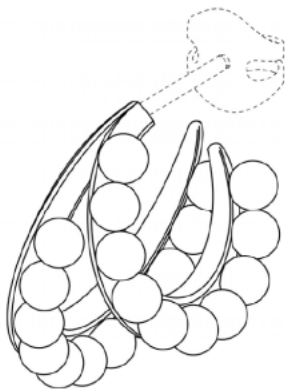

[11] 2118370.8M004

[15] 22-07-2021

[30] 01-06-2021 / JP / 011644 of 2021

[51] Cl. 11-01

[54] 戒指
Finger ring

[73] TASAKI & Co., Ltd.
3-2, 6-chome, Minatojima Naka-machi,
Chuo-ku, Kobe 650-0046,
Japan

[74] DEACONS
5th Floor, Alexandra House,
Central,
Hong Kong

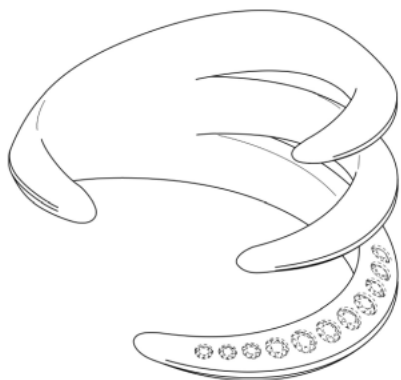

[11] 2118370.8M005

[15] 22-07-2021

[30] 01-06-2021 / JP / 011645 of 2021

[51] Cl. 11-01

[54] 耳環

Earring

[73] TASAKI & Co., Ltd.

3-2, 6-chome, Minatojima Naka-machi,

Chuo-ku, Kobe 650-0046,

Japan

[74] DEACONS

5th Floor, Alexandra House,

Central,

Hong Kong

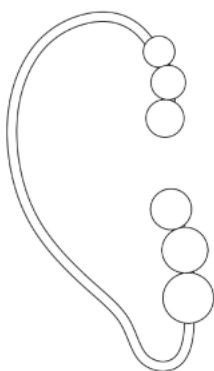

[11] 2118370.8M006

[15] 22-07-2021

[30] 01-06-2021 / JP / 011646 of 2021

[51] Cl. 11-01

[54] 耳環

Earring

[73] TASAKI & Co., Ltd.

3-2, 6-chome, Minatojima Naka-machi,

Chuo-ku, Kobe 650-0046,

Japan

[74] DEACONS

5th Floor, Alexandra House,

Central,

Hong Kong

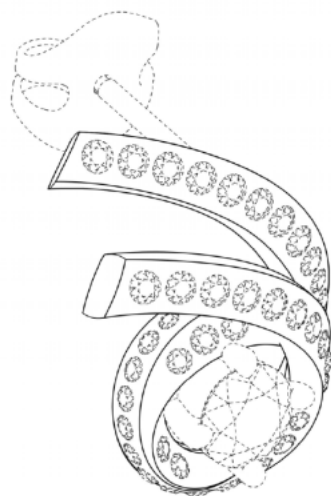

[11] 2118371.0

[15] 22-07-2021

[30] 30-03-2021 / JP / 006584 of 2021

[51] Cl. 14-02

[54] 個人識別裝置

Personal identification device

[73] Mitsubishi Electric Corporation

7-3, Marunouchi 2-chome,

Chiyoda-ku, Tokyo 100-8310,

Japan

[74] LIU, SHEN & ASSOCIATES

Room 3716, 37/F, Sun Hung Kai Centre,

30 Harbour Road,

Wanchai, Hong Kong

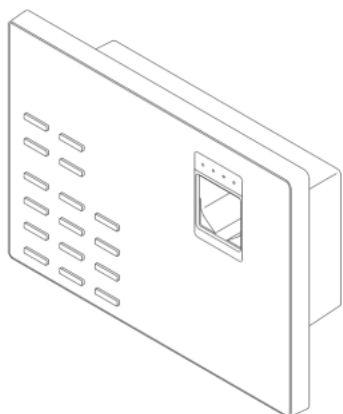

[11] 2118372.2M001

[15] 22-07-2021

[51] Cl. 9-03

[54] 包裝用標識或裝飾

Logo or ornamentation for packaging

[73] 聯合醫藥有限公司

Alliance Pharmaceuticals Limited

Avonbridge House, Bath Road, Chippenham, United Kingdom SN15

2BB,

United Kingdom

[74] SHANGHAI INTELLECTUAL PROPERTY OFFICE

Unit F, 20th Floor, Neich Tower,

128 Gloucester Road,

Hong Kong



[11] 2118372.2M002

[15] 22-07-2021

[51] Cl. 9-03

[54] 包裝用標識或裝飾

Logo or ornamentation for packaging

[73] 聯合醫藥有限公司

Alliance Pharmaceuticals Limited

Avonbridge House, Bath Road, Chippenham, United Kingdom SN15

2BB,

United Kingdom

[74] SHANGHAI INTELLECTUAL PROPERTY OFFICE

Unit F, 20th Floor, Neich Tower,

128 Gloucester Road,

Hong Kong



[11] 2118372.2M003

[15] 22-07-2021

[51] Cl. 9-03

[54] 包裝用標識或裝飾

Logo or ornamentation for packaging

[73] 聯合醫藥有限公司

Alliance Pharmaceuticals Limited

Avonbridge House, Bath Road, Chippenham, United Kingdom SN15

2BB,

United Kingdom

[74] SHANGHAI INTELLECTUAL PROPERTY OFFICE

Unit F, 20th Floor, Neich Tower,

128 Gloucester Road,

Hong Kong



[11] 2118372.2M004

[15] 22-07-2021

[51] Cl. 9-03

[54] 包裝用標識或裝飾

Logo or ornamentation for packaging

[73] 聯合醫藥有限公司

Alliance Pharmaceuticals Limited

Avonbridge House, Bath Road, Chippenham, United Kingdom SN15

2BB,

United Kingdom

[74] SHANGHAI INTELLECTUAL PROPERTY OFFICE

Unit F, 20th Floor, Neich Tower,

128 Gloucester Road,

Hong Kong



[11] 2118373.4M001

[15] 22-07-2021

[51] Cl. 9-03

[54] 包裝用盒

Packaging box

[73] 聯合醫藥有限公司

Alliance Pharmaceuticals Limited

Avonbridge House, Bath Road, Chippenham,

United Kingdom SN15 2BB,
United Kingdom

- [74] SHANGHAI INTELLECTUAL PROPERTY OFFICE
Unit F, 20th Floor, Neich Tower,
128 Gloucester Road,
Hong Kong



-
- [11] 2118373.4M002

[15] 22-07-2021

[51] Cl. 9-03

- [54] 包裝用盒
Packaging box

- [73] 聯合醫藥有限公司
Alliance Pharmaceuticals Limited
Avonbridge House, Bath Road, Chippenham,
United Kingdom SN15 2BB,
United Kingdom

- [74] SHANGHAI INTELLECTUAL PROPERTY OFFICE
Unit F, 20th Floor, Neich Tower,
128 Gloucester Road,
Hong Kong



[11] 2118373.4M003

[15] 22-07-2021

[51] Cl. 9-03

[54] 包裝用容器

Packaging container

[73] 聯合醫藥有限公司

Alliance Pharmaceuticals Limited

Avonbridge House, Bath Road, Chippenham,

United Kingdom SN15 2BB,

United Kingdom

[74] SHANGHAI INTELLECTUAL PROPERTY OFFICE

Unit F, 20th Floor, Neich Tower,

128 Gloucester Road,

Hong Kong



[11] 2118373.4M004

[15] 22-07-2021

[51] Cl. 9-03

[54] 包裝用容器

Packaging container

[73] 聯合醫藥有限公司

Alliance Pharmaceuticals Limited

Avonbridge House, Bath Road, Chippenham,

United Kingdom SN15 2BB,

United Kingdom

[74] SHANGHAI INTELLECTUAL PROPERTY OFFICE

Unit F, 20th Floor, Neich Tower,

128 Gloucester Road,

Hong Kong



[11] 2118374.6M001

[15] 22-07-2021

[30] 22-01-2021 / IT / 402021000000134

[51] Cl. 3-01

[54] 袋
Bag

[73] VALENTINO S.p.A.
Via Turati, 16/18,
I-20121 Milano,
Italy

[74] BARRON & YOUNG INTELLECTUAL PROPERTY LIMITED
Suite 617, Lakeside 2,
No. 10 Science Park West Avenue,
Hong Kong Science Park, Shatin, N.T., Hong Kong



[11] 2118374.6M002

[15] 22-07-2021

[30] 22-01-2021 / IT / 402021000000134

[51] Cl. 3-01

[54] 袋

Bag

[73] VALENTINO S.p.A.

Via Turati, 16/18,

I-20121 Milano,

Italy

[74] BARRON & YOUNG INTELLECTUAL PROPERTY LIMITED

Suite 617, Lakeside 2,

No. 10 Science Park West Avenue,

Hong Kong Science Park, Shatin, N.T., Hong Kong

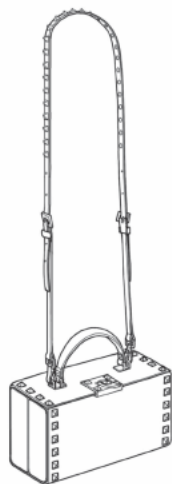

[11] 2118374.6M003

[15] 22-07-2021

[30] 22-01-2021 / IT / 402021000000134

[51] Cl. 3-01

[54] 袋

Bag

[73] VALENTINO S.p.A.

Via Turati, 16/18,

I-20121 Milano,

Italy

[74] BARRON & YOUNG INTELLECTUAL PROPERTY LIMITED

Suite 617, Lakeside 2,

No. 10 Science Park West Avenue,

Hong Kong Science Park, Shatin, N.T., Hong Kong



[11] 2118377.3

[15] 23-07-2021

[51] Cl. 11-04

[54] 貝殼形花藝品

Shell shaped flora art

[73] 粉紅寓言有限公司

PINK FABLE LIMITED

Unit 1118, 11th Floor, Tower B, Southmark,

11 Yip Hing Street,

Wong Chuk Hang, Hong Kong

[74] VINCENT LUK & ASSOCIATES

Unit A, 13th Floor, Nathan Commercial Building,

430 Nathan Road,

Kowloon, Hong Kong



[11] 2118378.5

[15] 23-07-2021

[51] Cl. 21-01

[54] 積木

Building block

[73] 佳樂專有限公司

Kalos Blocks Company Limited
9/F., Southeast Industrial Building,
611-619 Castle Peak Road,
Tsuen Wan, Hong Kong

[74] Hong Kong Intellectual Property Advisory Service Limited

1/F., FUK WO INDUSTRY BUILDING
5 SHEUNG HEI STREET, SAN PO KONG, KOWLOON
HONG KONG
HONG KONG

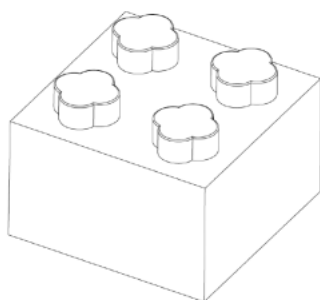

[11] 2118379.7

[15] 23-07-2021

[51] Cl. 21-01

[54] 積木

Building block

[73] 佳樂專有限公司

Kalos Blocks Company Limited
9/F., Southeast Industrial Building,
611-619 Castle Peak Road,
Tsuen Wan, Hong Kong

[74] HONG KONG INTELLECTUAL PROPERTY ADVISORY SERVICE LIMITED

Unit 1701, 17/F., Ew International Tower,
120 Texaco Road,
Tsuen Wan, New Territories, Hong Kong

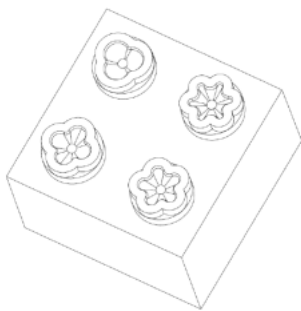

[11] 2118380.9

[15] 23-07-2021

[51] Cl. 21-01

[54] 積木

Building block

[73] 佳樂專有限公司

Kalos Blocks Company Limited

9/F., Southeast Industrial Building,

611-619 Castle Peak Road,

Tsuen Wan, Hong Kong

[74] Hong Kong Intellectual Property Advisory Service Limited

1/F., FUK WO INDUSTRY BUILDING

5 SHEUNG HEI STREET, SAN PO KONG, KOWLOON

HONG KONG

HONG KONG

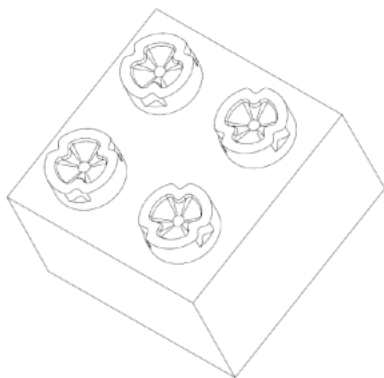

[11] 2118391.2M001

[15] 23-07-2021

[30] 05-02-2021 / US / 29/769,584

[51] Cl. 14-03

[54] 通訊頭戴式送受話器

Communications headset

[73] 繽特力股份有限公司

PLANTRONICS, INC.

345 Encinal Street,

Santa Cruz, CA 95060,

United States of America

[74] SHANGHAI INTELLECTUAL PROPERTY OFFICE

Unit F, 20th Floor, Neich Tower,

128 Gloucester Road,

Hong Kong



[11] 2118391.2M002

[15] 23-07-2021

[30] 05-02-2021 / US / 29/769,584

[51] Cl. 14-03

[54] 通訊頭戴式送受話器

Communications headset

[73] 繽特力股份有限公司

PLANTRONICS, INC.

345 Encinal Street,

Santa Cruz, CA 95060,

United States of America

[74] SHANGHAI INTELLECTUAL PROPERTY OFFICE

Unit F, 20th Floor, Neich Tower,

128 Gloucester Road,

Hong Kong



[11] 2118392.4M001

[15] 26-07-2021

[30] 12-04-2021 / US / 29/778,312

[51] Cl. 7-02

[54] 帶凹口的炊具

Notched utensil

[73] 拉戈姆廚房公司

Lagom Kitchen Co.

3924 Tuller Avenue,

Culver City, California, 90230,

United States of America

[74] CHINAHONGKONG PATENT LIMITED

1502, 15/F, Capital Centre

151 Gloucester Road, Wanchai

Hong Kong

HONG KONG

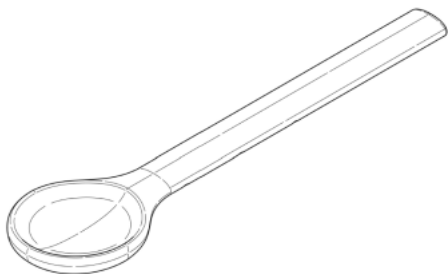

[11] 2118392.4M002

[15] 26-07-2021

[30] 12-04-2021 / US / 29/778,312

- [51] Cl. 7-02
- [54] 帶凹口的炊具
Notched utensil
- [73] 拉戈姆廚房公司
Lagom Kitchen Co.
3924 Tuller Avenue,
Culver City, California, 90230,
United States of America
- [74] CHINAHONGKONG PATENT LIMITED
1502, 15/F, Capital Centre
151 Gloucester Road, Wanchai
Hong Kong
HONG KONG

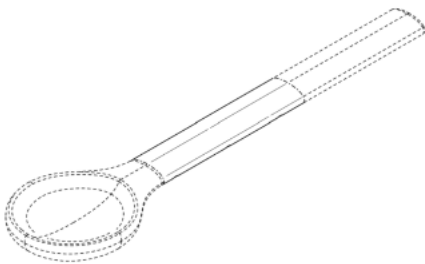

-
- [11] 2118393.6
- [15] 26-07-2021
- [30] 29-01-2021 / AM, AZ, BZ, BA, GE, LI, MK, MD, MC, MN, ME, MA,
NO, OM, RU, SG, CH, TN, TR, UA, GB, EU, AL, KG / DM/212 694
- [51] Cl. 10-07
- [54] 錶面
Dial
- [73] OMEGA SA (OMEGA AG) (OMEGA LTD.)
Jakob-Stämpfli-Strasse 96,
CH-2502 Biel/Bienne,
Switzerland
- [74] SPRUSON & FERGUSON (HONG KONG) LIMITED
5001 Hopewell Centre,
183 Queen's Road East,
Wan Chai, Hong Kong



[11] 2118395.1M001

[15] 26-07-2021

[51] Cl. 21-01

[54] 玩具馬廄

Toy stable

[73] 集美塑膠玩具製品廠有限公司

CHAP MEI PLASTIC TOYS MANUFACTORY LIMITED

Unit 541, 5/F., Sino Industrial Plaza,

9 Kai Cheung Road,

Kowloon Bay, Kowloon, Hong Kong

[74] BENNY KONG & TSAI

Unit 19B, Overseas Trust Bank Building,

No. 160 Gloucester Road,

Wanchai, Hong Kong



[11] 2118395.1M002

[15] 26-07-2021

[51] Cl. 21-01

[54] 玩具捕龍長拖頭

Toy dinosaur trailer

[73] 集美塑膠玩具製品廠有限公司

CHAP MEI PLASTIC TOYS MANUFACTORY LIMITED

Unit 541, 5/F., Sino Industrial Plaza,

9 Kai Cheung Road,

Kowloon Bay, Kowloon, Hong Kong

[74] BENNY KONG & TSAI

Unit 19B, Overseas Trust Bank Building,

No. 160 Gloucester Road,

Wanchai, Hong Kong



[11] 2118396.3

[15] 26-07-2021

[30] 04-02-2021 / AM, AZ, BZ, BA, GE, LI, MK, MD, MC, MN, ME, MA,
NO, OM, RU, SG, CH, TN, TR, UA, GB, EU, AL, KG / DM/212 608

[51] Cl. 10-02

[54] 錶

Watch

[73] OMEGA SA (OMEGA AG) (OMEGA LTD.)

Jakob-Stämpfli-Strasse 96,
CH-2502 Biel/Bienne,
Switzerland

[74] SPRUSON & FERGUSON (HONG KONG) LIMITED

5001 Hopewell Centre,
183 Queen's Road East,
Wan Chai, Hong Kong



[11] 2118400.3

[15] 26-07-2021

[51] Cl. 14-02

[54] 用於監控移動設備的溫度和位置的智能閱讀器

Smart reader for monitoring temperature and location of mobile
device

[73] Megasoft Limited

Unit 301-302, 3/F, Building 12W,
No. 12 Science Park West Avenue,

Hong Kong Science Park,
Shatin, New Territories, Hong Kong

- [74] BARRON & YOUNG INTELLECTUAL PROPERTY LIMITED
Suite 617, Lakeside 2,
No. 10 Science Park West Avenue,
Hong Kong Science Park, Shatin, N.T., Hong Kong

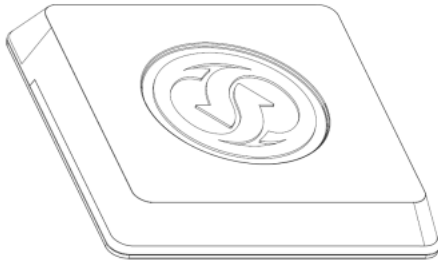

-
- [11] 2118401.5
[15] 26-07-2021
[51] Cl. 14-02
[54] 用於監測物體的溫度和位置的智能手提箱
Smart container for monitoring items' temperature and location
[73] Megasoft Limited
Unit 301-302, 3/F, Building 12W,
No. 12 Science Park West Avenue,
Hong Kong Science Park,
Shatin, New Territories, Hong Kong
[74] BARRON & YOUNG INTELLECTUAL PROPERTY LIMITED
Suite 617, Lakeside 2,
No. 10 Science Park West Avenue,
Hong Kong Science Park, Shatin, N.T., Hong Kong

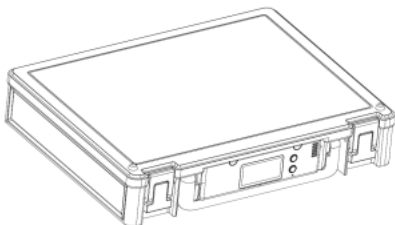

-
- [11] 2118402.7
[15] 27-07-2021
[30] 15-02-2021 / EU / 008435341-0002

[51] Cl. 3-01

[54] 行李箱套

Suitcase cover

[73] Rimowa GmbH

Richard-Byrd-Str. 13,

50829 Cologne,

Germany

[74] ROBIN BRIDGE & JOHN LIU

6th Floor, Emperor Commercial Centre,

39 Des Voeux Road Central,

Hong Kong

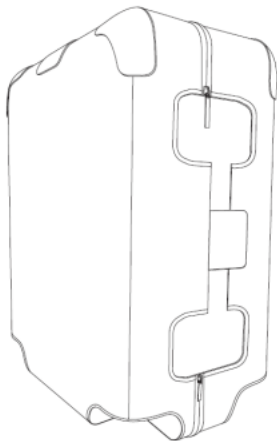

[11] 2118403.9

[15] 27-07-2021

[51] Cl. 12-16

[54] 汽車太陽擋

Sunshade for car

[73] 梁健輝

Leung Kin Fai

香港九龍

土瓜灣上鄉道 39-41 號

昌華工廠大廈 6 樓 C1 至 2 室

[74] 卓遠知識產權有限公司

香港上環

禧利街 27 號

富輝商業中心 10 樓



[11] 2118404.1

[15] 27-07-2021

[51] Cl. 14-02

[54] 帶有射頻標籤讀取器和盒式分區檢測的智能託盤

Smart tray with RFID reader and box partition detection

[73] Megasoft Limited

Unit 301-302, 3/F, Building 12W,

No. 12 Science Park West Avenue,

Hong Kong Science Park,

Shatin, New Territories, Hong Kong

[74] BARRON & YOUNG INTELLECTUAL PROPERTY LIMITED

Suite 617, Lakeside 2,

No. 10 Science Park West Avenue,

Hong Kong Science Park, Shatin, N.T., Hong Kong

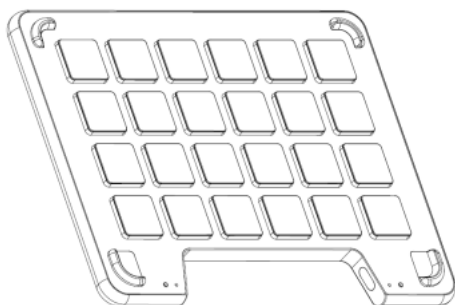

[11] 2118407.8

[15] 27-07-2021

[51] Cl. 26-02

[54] 工作燈

Work light

[73] 飛龍發展有限公司

FLYING DRAGON DEVELOPMENT LIMITED

Unit B, 6/F., Unison Industrial Centre,

27-31 Au Pui Wan Street,
Fotan, Shatin, New Territories, Hong Kong

[74] BENNY KONG & TSAI
Unit 19B, Overseas Trust Bank Building,
No. 160 Gloucester Road,
Wanchai, Hong Kong

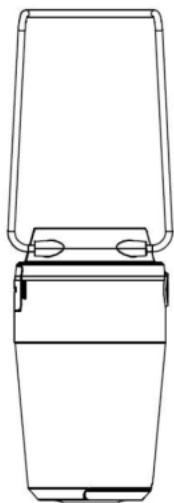

[11] 2118410.4

[15] 27-07-2021

[30] 21-05-2021 / CN / 202130306538.6

[51] Cl. 13-02

[54] 無線充

Wireless charger

[73] 廣東高普達集團股份有限公司

GUANGDONG GOPOD GROUP HOLDING CO., LTD

中國內地

廣東省深圳市龍華新區大浪街道同勝社區華榮路

聯建科技工業園廠房 8 棟 4, 5, 6 樓

[74] 中一聯合國際知識產權有限公司

香港九龍

尖沙咀漆咸道南 45-51 號

其士大廈 803 室

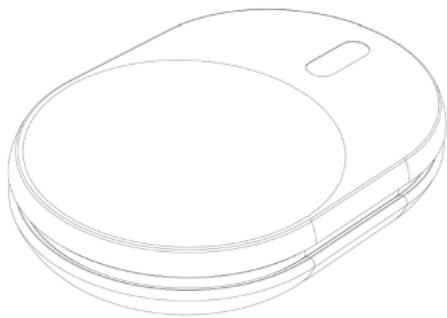

[11] 2118412.8

[15] 28-07-2021

[51] Cl. 23-04

[54] 吊扇

Ceiling fan

[73] 未來照明有限公司

Future Lighting Collection Limited

11/F., Chung Kiu Godown Building,

63-71 Lei Muk Road,

Kwai Chung, New Territories, Hong Kong

[74] TMCR Intellectual Property (Patent) Limited

Unit 2505, 25/F., Billion Plaza,

8 Cheung Yue Street,

Cheung Sha Wan, Kowloon, Hong Kong

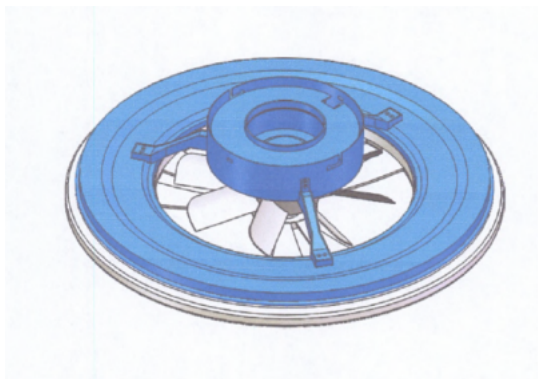

[11] 2118414.2M001

[15] 28-07-2021

[30] 29-01-2021 / US / 29/768,578

[51] Cl. 14-03

[54] 視頻會議設備

Video conference device

[73] 續特力股份有限公司

PLANTRONICS, INC.
345 Encinal Street,
Santa Cruz, CA 95060,
United States of America

[74] SHANGHAI INTELLECTUAL PROPERTY OFFICE

Unit F, 20th Floor, Neich Tower,
128 Gloucester Road,
Hong Kong

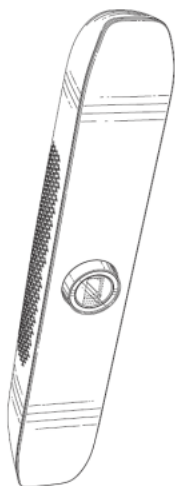

[11] 2118414.2M002

[15] 28-07-2021

[30] 29-01-2021 / US / 29/768,578

[51] Cl. 14-03

[54] 視頻會議設備

Video conference device

[73] 續特力股份有限公司

PLANTRONICS, INC.
345 Encinal Street,
Santa Cruz, CA 95060,
United States of America

[74] SHANGHAI INTELLECTUAL PROPERTY OFFICE

Unit F, 20th Floor, Neich Tower,
128 Gloucester Road,
Hong Kong

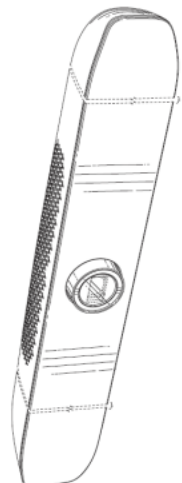

[11] 2118414.2M003

[15] 28-07-2021

[30] 29-01-2021 / US / 29/768,578

[51] Cl. 14-03

[54] 視頻會議設備

Video conference device

[73] 續特力股份有限公司

PLANTRONICS, INC.

345 Encinal Street,

Santa Cruz, CA 95060,

United States of America

[74] SHANGHAI INTELLECTUAL PROPERTY OFFICE

Unit F, 20th Floor, Neich Tower,

128 Gloucester Road,

Hong Kong

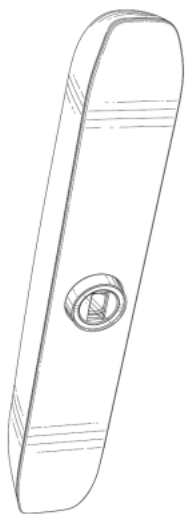

[11] 2118414.2M004

[15] 28-07-2021

[30] 29-01-2021 / US / 29/768,578

[51] Cl. 14-03

[54] 視頻會議設備

Video conference device

[73] 續特力股份有限公司

PLANTRONICS, INC.

345 Encinal Street,

Santa Cruz, CA 95060,

United States of America

[74] SHANGHAI INTELLECTUAL PROPERTY OFFICE

Unit F, 20th Floor, Neich Tower,

128 Gloucester Road,

Hong Kong

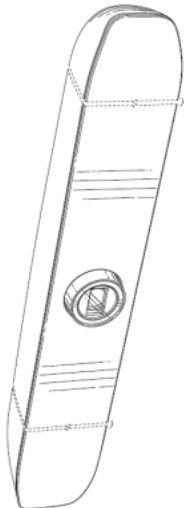

[11] 2118415.5M001

[15] 28-07-2021

[30] 29-01-2021 / US / 29/768,588

[51] Cl. 14-02

[54] 具有綜合攝像頭的電腦顯示屏

Computer display with integrated camera

[73] 續特力股份有限公司

PLANTRONICS, INC.

345 Encinal Street,

Santa Cruz, CA 95060,

United States of America

[74] SHANGHAI INTELLECTUAL PROPERTY OFFICE

Unit F, 20th Floor, Neich Tower,

128 Gloucester Road,
Hong Kong

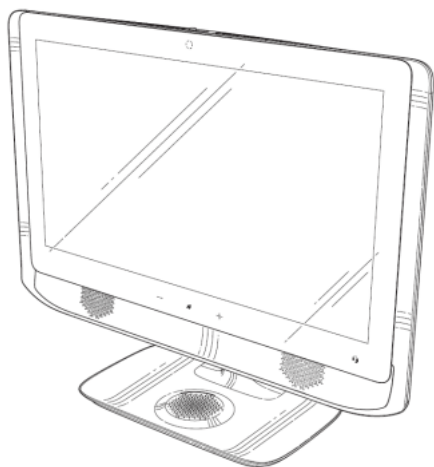

[11] 2118415.5M002

[15] 28-07-2021

[30] 29-01-2021 / US / 29/768,588

[51] Cl. 14-02

[54] 具有綜合攝像頭的電腦顯示屏
Computer display with integrated camera

[73] 續特力股份有限公司
PLANTRONICS, INC.
345 Encinal Street,
Santa Cruz, CA 95060,
United States of America

[74] SHANGHAI INTELLECTUAL PROPERTY OFFICE
Unit F, 20th Floor, Neich Tower,
128 Gloucester Road,
Hong Kong



[11] 2118419.3

[15] 28-07-2021

[51] Cl. 14-01

[54] 數字音頻播放器

Digital audio player

[73] Dreamus Company

311, Gangnam-daero,

Seocho-gu, Seoul, 06628,

Korea, Republic of

[74] Rouse & Co. International (Overseas) Limited

26/F., Tesbury Centre,

28 Queen's Road East,

Hong Kong

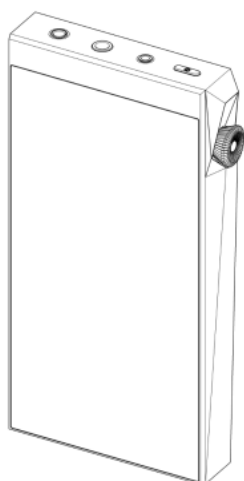

[11] 2118420.5M001

[15] 28-07-2021

[51] Cl. 9-07

[54] 瓶蓋

Flask cap

[73] BEAUTE PRESTIGE INTERNATIONAL
56A rue du Faubourg Saint-Honoré,
75008 Paris,
France

[74] WENPING PATENT & TRADE MARK AGENT LIMITED
1701 Tung Wai Commercial Building,
111 Gloucester Road,
Hong Kong



[11] 2118420.5M002

[15] 28-07-2021

[51] Cl. 9-07

[54] 瓶蓋

Flask cap

[73] BEAUTE PRESTIGE INTERNATIONAL
56A rue du Faubourg Saint-Honoré,
75008 Paris,
France

[74] WENPING PATENT & TRADE MARK AGENT LIMITED
1701 Tung Wai Commercial Building,
111 Gloucester Road,
Hong Kong



[11] 2118421.7

[15] 29-07-2021

[30] 09-06-2021 / CN / 202130355569.0

[51] Cl. 9-03

[54] 包裝盒

Package box

[73] 北京同仁堂國藥有限公司

BEIJING TONG REN TANG CHINESE MEDICINE COMPANY LIMITED

香港新界

大埔工業邨

大景街 3 號

[74] 中港知識產權有限公司

香港

灣仔告士打道 151 號

資本中心 15 樓 1502 室

HONG KONG



[11] 2118422.9

[15] 29-07-2021

[30] 09-06-2021 / CN / 202130355584.5

[51] Cl. 9-03

[54] 包裝盒

Package box

[73] 北京同仁堂國藥有限公司

BEIJING TONG REN TANG CHINESE MEDICINE COMPANY LIMITED

香港新界

大埔工業邨

大景街 3 號

[74] 中港知識產權有限公司

香港

灣仔告士打道 151 號

資本中心 15 樓 1502 室

HONG KONG



[11] 2118702.4

[15] 17-09-2021

[51] Cl. 23-04

[54] 空氣淨化殺菌機器人

Air purification and disinfection robot

[73] CCI Limited

D1, 11/F., Gee Chang Hong Centre,

65 Wong Chuk Hang Road,

Hong Kong

[74] CCI Limited
D1, 11/F, Gee Chang Hong Centre,
65 Wong Chuk Hang Road,
Hong Kong





香港特別行政區政府知識產權署外觀設計註冊處

The Government of the Hong Kong Special Administrative Region

Designs Registry, Intellectual Property Department

根據註冊外觀設計條例第 28 條，下列註冊外觀設計因未繳續期費而停止有效。

各組記項按註冊外觀設計停止有效日期及註冊編號先後次序排列。

Registered designs ceased through non-payment of renewal fees under section 28 of the Registered Designs Ordinance. Entries are listed below under their expiry dates.

18-08-2021 - 08-09-2021

18-08-2021	1601595.0	1601624.2M002
0602204.0	1601601.4	1601624.2M003
0602205.3		
1101422.8M002	23-08-2021	27-08-2021
1101423.0	0111279.4	0111296.0
1601585.9	0602222.8M002	
	0602232.9	28-08-2021
19-08-2021	1101451.9M001	0111303.6M001
1601586.1M001	1101451.9M002	0111303.6M002
1601586.1M002	1601603.8	1101468.5M001
1601646.9	1601605.3M001	1101468.5M002
	1601605.3M002	1101468.5M003
20-08-2021	1601605.3M003	1101468.5M004
0111261.6	1601605.3M004	1101468.5M005
	1601606.5	1101468.5M006
21-08-2021	1601607.7M004	1101468.5M007
1101425.5M001	1601608.9	1101468.5M008
1601588.5M002		1101468.5M009
1601588.5M003	24-08-2021	1101468.5M010
1601590.9	1101458.4M001	1101468.5M011
1601591.1	1101458.4M004	1101468.5M012
	1101458.4M006	1101468.5M013
22-08-2021	1601612.7	1101468.5M014
0602220.4M001	1601613.9	1101468.5M015
1101432.9		1101468.5M016
1101441.8M001	25-08-2021	1101468.5M017
1101441.8M002	1101459.6M004	1101472.3
1101441.8M003	1601621.6M001	1601630.5
1101441.8M004	1601621.6M002	1601631.7
1101443.2	1601621.6M003	1601632.9
1101444.4M001	1601621.6M004	1601634.3M001
1101444.4M002	1601621.6M005	1601634.3M002
1101445.7	1601623.0	1601636.8
1601594.7	1601624.2M001	1601637.0M001

1601637.0M002
1601637.0M003

29-08-2021

0602271.1M001
0602271.1M002
0602271.1M003
0602278.6M002
1601639.4
1601640.6M002
1601644.4M001
1601644.4M002
1601644.4M003
1601648.3
1601649.5M001
1601649.5M002
1601649.5M003
1601649.5M004
1601649.5M005
1601649.5M006
1601649.5M007
1601649.5M008
1601649.5M009
1601649.5M010
1601649.5M011
1601649.5M012
1601649.5M013
1601649.5M014
1601649.5M015
1601650.7
1601651.9M001
1601651.9M002
1601651.9M003
1601651.9M004
1601651.9M005
1601651.9M006
1601651.9M007
1601651.9M008
1601653.3

30-08-2021

0602295.2
1101483.6
1101488.7
1101489.9
1101490.1
1101491.3
1601654.5M002

1601654.5M003
1601656.0M002
1601656.0M003
1601663.4

31-08-2021

0602302.8
1601664.6
1601665.9
1601666.1
1601667.3
1601668.5
1601671.1
1601672.3
1601673.5

01-09-2021

1101504.3
1101508.2
1101510.6M002
1101510.6M003
1101510.6M005
1101510.6M006
1601674.7M001
1601674.7M002
1601676.2
1601678.6M001
1601678.6M002
1601680.0
1601681.2M001
1601681.2M004
1601681.2M005
1601684.8
1601685.1M001
1601685.1M002
1601685.1M003
1601685.1M004

03-09-2021

0111324.0

04-09-2021

0111328.9
1601642.0
1601689.9
1601691.3M001
1601691.3M002
1601692.5M001

1601692.5M002
1601692.5M003
1601692.5M004
1601692.5M005
1601692.5M006
1601692.5M007
1601692.5M008

05-09-2021

1101527.2M001
1101531.0M001
1101531.0M002
1101531.0M003
1101532.2M001
1101532.2M002
1101533.4M001
1101533.4M002
1101534.6M001
1101534.6M002
1601698.8M002
1601698.8M003
1601701.6
1601708.1M002
1601708.1M003
1601708.1M004
1601708.1M005

06-09-2021

0602339.6
0602344.6
1601712.9M001
1601712.9M002
1601712.9M003
1601715.6
1601716.8
1601717.0

07-09-2021

0602347.3
1101541.1
1101548.6M002

08-09-2021

1101552.4
1101556.3
1101557.5
1101558.7
1101559.9

1101560.1
1101563.7
1601727.1M001
1601727.1M002
1601728.3M001
1601728.3M002
1601734.5
1601735.8
1601738.4
1601739.6



香港特別行政區政府知識產權署外觀設計註冊處

The Government of the Hong Kong Special Administrative Region

Designs Registry, Intellectual Property Department

根據註冊外觀設計規則第 31 條刪除的註冊外觀設計。各組記項按註冊外觀設計刪除日期及註冊編號先後次序排列。

Registered designs removed under section 31 of the Registered Designs Rules. Entries are listed below under their removal dates.

30-09-2021 - 07-10-2021

30-09-2021	0600480.2	1100347.8M003
1502732.1	0600481.4M001	1100347.8M004
1600269.7	0600481.4M002	1100347.8M005
1600273.5	0600481.4M004	1100347.8M006
	0600483.8	1100347.8M007
01-10-2021	0600489.1M001	1100352.8
0110232.4	0600489.1M002	1100353.0
0110233.6M001	0600489.1M003	1600277.4M001
0110233.6M002	0600489.1M004	1600277.4M002
0110233.6M003	0600489.1M005	1600277.4M003
0110233.6M004	0600489.1M008	1600277.4M004
0110238.7M001	0600498.0	1600288.7
0110249.0	0600500.7	1600290.1
0110251.4M001	0600501.9	1600291.3M001
0110252.6M001	0600502.1M001	1600291.3M002
0110259.1M001	0600502.1M002	1600291.3M003
0110259.1M002	1100283.1	1600291.3M004
0110287.0M001	1100302.3	1600291.3M005
0110287.0M002	1100303.5	1600291.3M006
0600430.7M047	1100305.0	1600291.3M007
0600430.7M048	1100309.8	1600292.5
0600430.7M049	1100314.8M002	1600295.2M001
0600430.7M053	1100314.8M003	1600295.2M002
0600430.7M054	1100324.9M001	1600297.6
0600430.7M055	1100324.9M002	1600298.8M001
0600450.9	1100324.9M003	1600298.8M002
0600457.4M001	1100324.9M004	1600298.8M003
0600457.4M002	1100324.9M005	1600298.8M004
0600457.4M003	1100331.4	1600298.8M005
0600457.4M004	1100338.9M001	1600298.8M006
0600457.4M005	1100338.9M002	1600298.8M007
0600457.4M006	1100345.4	1600298.8M008
0600466.3	1100347.8M001	1600298.8M009
0600479.0	1100347.8M002	1600298.8M010

1600298.8M011	1600340.8	
1600298.8M012	1600341.0	05-10-2021
1600298.8M013	1600344.6	1600382.6
1600298.8M014	1600345.9	1600383.8M001
1600298.8M015	1600351.1M002	1600383.8M002
1600298.8M016	1600355.0	1600383.8M003
1600298.8M017	1600356.2	1600384.0
1600298.8M018	1600357.4	1600385.3
1600298.8M019	1600358.6	1600386.5
1600298.8M020	1600360.0	
1600298.8M021	1600361.2	06-10-2021
1600298.8M022	1600362.4	0600536.3
1600298.8M023	1600363.6M001	1100393.4M001
1600298.8M024	1600364.8	1100393.4M002
1600299.0M001		1100393.4M003
1600299.0M002	02-10-2021	1600392.7M001
1600299.0M003	0600517.3	1600392.7M002
1600299.0M004	1100354.2	1600395.4
1600299.0M005	1100360.5M001	
1600299.0M006	1100360.5M002	07-10-2021
1600299.0M007	1100360.5M003	0600543.7
1600299.0M008	1100371.8	1600397.8
1600299.0M009	1100372.0	1600398.0
1600307.9	1100375.7	
1600308.1	1600373.7M001	
1600309.3	1600373.7M002	
1600310.5	1600373.7M003	
1600311.7	1600373.7M004	
1600312.9	1600373.7M005	
1600313.1	1600373.7M006	
1600314.3	1600373.7M007	
1600315.6	1600373.7M008	
1600316.8	1600373.7M009	
1600318.2	1600373.7M010	
1600319.4M001	1600374.9M001	
1600319.4M002	1600374.9M002	
1600324.4M002	1600379.0	
1600324.4M003		
1600326.9	04-10-2021	
1600327.1	0600513.4	
1600328.3	0600514.6	
1600329.5	0600518.5M002	
1600330.7	0600518.5M003	
1600331.9	0600518.5M004	
1600333.3M002	0600518.5M005	
1600334.5M002	0600518.5M006	
1600338.4	0600519.7	
1600339.6	0600524.7	