

香港知識產權公報

Hong Kong Intellectual Property Journal

2021年7月23日

23 July 2021

目錄 Contents

根據註冊外觀設計條例第 25 條註冊的外觀設計

Designs Registered under section 25 of the Registered Designs Ordinance

按註冊編號排列

Arranged by Registration Number

根據註冊外觀設計條例(第 522 章)公布的其他公告

Other Notices Published under the Registered Designs Ordinance (Cap. 522)

根據註冊外觀設計條例第 28 條，註冊外觀設計因未繳續期費而停止有效

Registered designs ceased through non-payment of renewal fees under section 28 of the Registered Designs Ordinance

根據註冊外觀設計規則第 31 條刪除的註冊外觀設計

Registered designs removed under section 31 of the Registered Designs Rules

根據註冊外觀設計條例第 76 條，更正已提交文件中的錯誤

Correction of errors in filed documents under section 76 of the Registered Designs Ordinance

以下事項沒有記錄

No Records for the Following Matters

根據註冊外觀設計條例第 30 條放棄的外觀設計的註冊

Surrender of Registration of Design under section 30 of the Registered Designs Ordinance

根據註冊外觀設計規則第 37 條，向處長作出轉介

Reference to Registrar under section 37 of the Registered Designs Rules

根據註冊外觀設計條例第 45 條，撤銷註冊

Revocation of Registration under section 45 of the Registered Designs Ordinance

根據註冊外觀設計規則第 46 條，向法院作出轉介

Reference to Court under section 46 of the Registered Designs Rules

根據註冊外觀設計規則第 63 條對不符合規定之處作出糾正

Rectification of Irregularities under section 63 of the Registered Designs Rules

根據註冊外觀設計條例第 66 條，糾正註冊紀錄冊

Rectification of Register under section 66 of the Registered Designs Ordinance

根據註冊外觀設計條例第 67 條 更正註冊紀錄冊內的錯誤

Correction of errors in Register under section 67 of the Registered Designs Ordinance

根據註冊外觀設計條例第 67 及 76 條，更正註冊紀錄冊內及已提交文件中的錯誤

Correction of Errors in Register and in Filed Documents under sections 67 and 76 of the Registered Designs Ordinance

勘誤

Corrigendum

註冊外觀設計公告註釋

Notes on advertisements of registration of designs

方括號表示下列資料：

Square brackets indicate the following data：

[11] 註冊編號 Registration number / 聯合王國註冊編號 United Kingdom registration number

[15] 註冊日期 Registration date / 當作註冊日期 Deemed registration date / 聯合王國註冊日期 United Kingdom registration date

[17] 註冊有效期屆滿日期 Expiry date of the period of registration

[22] 提交日期 Filing date / 當作提交日期 Deemed filing date / 聯合王國提交日期 United Kingdom filing date

[30] 聲稱享有的優先權（提交日期 / 巴黎公約國或世界貿易組織成員 / 申請編號） Priority claimed (filing date / Paris Convention country or WTO member / application number)

[51] 國際外觀設計分類號（洛迦諾分類號） International Classification of designs (Locarno Classification)

[54] 物品 Article

[55] 外觀設計的表述 Representation of the design

[62] 分開前的申請編號及提交日期 Application number before division and filing date

[66] 過往註冊的聯繫外觀設計註冊編號 / 日期 Registration No. / Date of Previous Registration for Association

[72] 設計人 Designer

[73] 擁有人姓名和地址 Name and address of the owner

[74] 代理人 Agent /送達地址 Address for service



香港特別行政區政府知識產權署外觀設計註冊處

The Government of the Hong Kong Special Administrative Region

Designs Registry, Intellectual Property Department

根據註冊外觀設計條例第 25 條註冊的外觀設計

Designs registered under section 25 of the Registered Designs Ordinance

按註冊編號排列

Arranged by Registration Number

[11] 2016744.9M001

[15] 28-08-2020

[30] 28-02-2020 / DE / 40 2020 100 204.6

[51] Cl. 21-01

[54] 玩具或比例模型車

Toy or scale model vehicle

[73] Bayerische Motoren Werke Aktiengesellschaft

Petuelring 130,

80809 Muenchen,

Germany

[74] HASTINGS & CO

5/F Gloucester Tower, The Landmark,

11 Pedder Street,

Central, Hong Kong



[11] 2016744.9M002

[15] 28-08-2020

[30] 28-02-2020 / DE / 40 2020 100 204.6

[51] Cl. 21-01

[54] 玩具或比例模型車

Toy or scale model vehicle

[73] Bayerische Motoren Werke Aktiengesellschaft

Petuelring 130,

80809 Muenchen,
Germany

- [74] HASTINGS & CO
5/F Gloucester Tower, The Landmark,
11 Pedder Street,
Central, Hong Kong



[11] 2017335.3M001

[15] 25-12-2020

[30] 26-06-2020 / US / 29/739,576

[51] Cl. 3-01

[54] 用於電子裝置的附件
Accessory for an electronic device

[73] 蘋果公司
APPLE INC.
One Apple Park Way, Cupertino,
California 95014,
United States

[74] CLT PATENT & TRADEMARK (H.K.) LIMITED
Unit 09, 34/F., Office Tower, Convention Plaza,
No. 1 Harbour Road,
Wanchai, Hong Kong

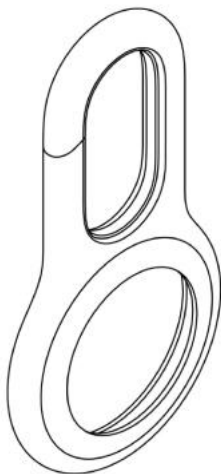

[11] 2017335.3M002

[15] 25-12-2020

[30] 26-06-2020 / US / 29/739,576

[51] Cl. 3-01

[54] 帶有電子裝置的附件

Accessory with an electronic device

[73] 蘋果公司

APPLE INC.

One Apple Park Way, Cupertino,

California 95014,

United States

[74] CLT PATENT & TRADEMARK (H.K.) LIMITED

Unit 09, 34/F., Office Tower, Convention Plaza,

No. 1 Harbour Road,

Wanchai, Hong Kong

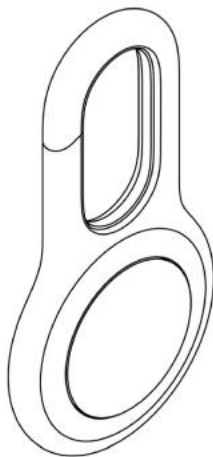

[11] 2017355.5M001

[15] 30-12-2020

[30] 30-06-2020 / EU / 008026215-0001

[51] Cl. 24-04

[54] 吸收物品

Absorbent article

[73] Essity Hygiene and Health Aktiebolag

Mölnbäcks väg 2,

405 03 Göteborg,

Sweden

[74] DEACONS

5th Floor, Alexandra House,

Central,

Hong Kong

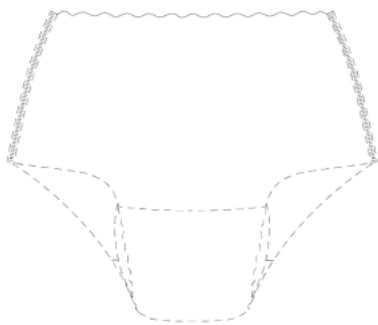

[11] 2017355.5M002

[15] 30-12-2020

[30] 30-06-2020 / EU / 008026215-0002

[51] Cl. 24-04

[54] 吸收物品

Absorbent article

[73] Essity Hygiene and Health Aktiebolag

Mölndals bro 2,

405 03 Göteborg,

Sweden

[74] DEACONS

5th Floor, Alexandra House,

Central,

Hong Kong



[11] 2017355.5M003

[15] 30-12-2020

[30] 30-06-2020 / EU / 008026215-0004

[51] Cl. 24-04

[54] 吸收物品

Absorbent article

[73] Essity Hygiene and Health Aktiebolag
Mölndals bro 2,
405 03 Göteborg,
Sweden

[74] DEACONS
5th Floor, Alexandra House,
Central,
Hong Kong

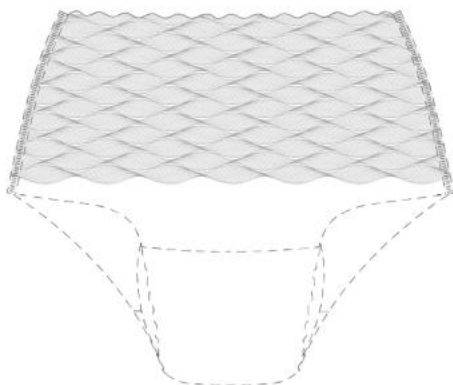

[11] 2017355.5M004

[15] 30-12-2020

[30] 30-06-2020 / EU / 008026215-0006

[51] Cl. 24-04

[54] 吸收物品
Absorbent article

[73] Essity Hygiene and Health Aktiebolag
Mölndals bro 2,
405 03 Göteborg,
Sweden

[74] DEACONS
5th Floor, Alexandra House,
Central,
Hong Kong



[11] 2117513.2M001

[15] 29-01-2021

[30] 01-08-2020 / EU / 008062731

[51] Cl. 14-01

[54] 耳機

Headphone

[73] Bang & Olufsen A/S

Bang og Olufsen Allé 1,

7600 Struer,

Denmark

[74] HOGAN LOVELLS

11th Floor, One Pacific Place,

88 Queensway,

Hong Kong



[11] 2117513.2M002

[15] 29-01-2021

[30] 01-08-2020 / EU / 008062731

[51] Cl. 14-01

[54] 耳機

Headphone

[73] Bang & Olufsen A/S

Bang og Olufsen Allé 1,

7600 Struer,

Denmark

[74] HOGAN LOVELLS

11th Floor, One Pacific Place,

88 Queensway,

Hong Kong



[11] 2118091.6M001

[15] 02-06-2021

[51] Cl. 11-01

[54] 飾物設計

Ornament design

[73] 六福集團有限公司

Luk Fook Holdings Company Limited

Floor 15, 20, 25 & 27, Metropole Square,

No.2 On Yiu Street,

Shatin, New Territories, Hong Kong

[74] Luk Fook Holdings Company Limited (Legal Affairs Department)

Floor 25, Metropole Square,

No.2 On Yiu Street,

Shatin, New Territories, Hong Kong



[11] 2118091.6M002

[15] 02-06-2021

[51] Cl. 11-01

[54] 飾物設計

Ornament design

[73] 六福集團有限公司

Luk Fook Holdings Company Limited

Floor 15, 20, 25 & 27, Metropole Square,

No.2 On Yiu Street,

Shatin, New Territories, Hong Kong

[74] Luk Fook Holdings Company Limited (Legal Affairs Department)

Floor 25, Metropole Square,

No.2 On Yiu Street,

Shatin, New Territories, Hong Kong



[11] 2118091.6M003

[15] 02-06-2021

[51] Cl. 11-01

[54] 飾物設計

Ornament design

[73] 六福集團有限公司

Luk Fook Holdings Company Limited

Floor 15, 20, 25 & 27, Metropole Square,

No.2 On Yiu Street,
Shatin, New Territories, Hong Kong

- [74] Luk Fook Holdings Company Limited (Legal Affairs Department)
Floor 25, Metropole Square,
No.2 On Yiu Street,
Shatin, New Territories, Hong Kong



[11] 2118091.6M004

[15] 02-06-2021

[51] Cl. 11-01

[54] 飾物設計

Ornament design

[73] 六福集團有限公司

Luk Fook Holdings Company Limited
Floor 15, 20, 25 & 27, Metropole Square,
No.2 On Yiu Street,
Shatin, New Territories, Hong Kong

- [74] Luk Fook Holdings Company Limited (Legal Affairs Department)
Floor 25, Metropole Square,
No.2 On Yiu Street,
Shatin, New Territories, Hong Kong



[11] 2118091.6M005

[15] 02-06-2021

[51] Cl. 11-01

[54] 飾物設計

Ornament design

[73] 六福集團有限公司

Luk Fook Holdings Company Limited

Floor 15, 20, 25 & 27, Metropole Square,

No.2 On Yiu Street,

Shatin, New Territories, Hong Kong

[74] Luk Fook Holdings Company Limited (Legal Affairs Department)

Floor 25, Metropole Square,

No.2 On Yiu Street,

Shatin, New Territories, Hong Kong



[11] 2118091.6M006

[15] 02-06-2021

[51] Cl. 11-01

[54] 飾物設計

Ornament design

[73] 六福集團有限公司

Luk Fook Holdings Company Limited

Floor 15, 20, 25 & 27, Metropole Square,

No.2 On Yiu Street,

Shatin, New Territories, Hong Kong

[74] Luk Fook Holdings Company Limited (Legal Affairs Department)

Floor 25, Metropole Square,

No.2 On Yiu Street,

Shatin, New Territories, Hong Kong

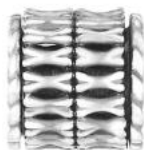

[11] 2118091.6M007

[15] 02-06-2021

[51] Cl. 11-01

[54] 飾物設計

Ornament design

[73] 六福集團有限公司

Luk Fook Holdings Company Limited

Floor 15, 20, 25 & 27, Metropole Square,

No.2 On Yiu Street,

Shatin, New Territories, Hong Kong

[74] Luk Fook Holdings Company Limited (Legal Affairs Department)

Floor 25, Metropole Square,

No.2 On Yiu Street,

Shatin, New Territories, Hong Kong



[11] 2118091.6M008

[15] 02-06-2021

[51] Cl. 11-01

[54] 飾物設計

Ornament design

[73] 六福集團有限公司

Luk Fook Holdings Company Limited

Floor 15, 20, 25 & 27, Metropole Square,

No.2 On Yiu Street,

Shatin, New Territories, Hong Kong

- [74] Luk Fook Holdings Company Limited (Legal Affairs Department)
Floor 25, Metropole Square,
No.2 On Yiu Street,
Shatin, New Territories, Hong Kong



[11] 2118091.6M009

[15] 02-06-2021

[51] Cl. 11-01

[54] 飾物設計

Ornament design

[73] 六福集團有限公司

Luk Fook Holdings Company Limited
Floor 15, 20, 25 & 27, Metropole Square,
No.2 On Yiu Street,
Shatin, New Territories, Hong Kong

- [74] Luk Fook Holdings Company Limited (Legal Affairs Department)
Floor 25, Metropole Square,
No.2 On Yiu Street,
Shatin, New Territories, Hong Kong



[11] 2118091.6M010

[15] 02-06-2021

[51] Cl. 11-01

[54] 飾物設計

Ornament design

[73] 六福集團有限公司

Luk Fook Holdings Company Limited
Floor 15, 20, 25 & 27, Metropole Square,
No.2 On Yiu Street,
Shatin, New Territories, Hong Kong

[74] Luk Fook Holdings Company Limited (Legal Affairs Department)

Floor 25, Metropole Square,
No.2 On Yiu Street,
Shatin, New Territories, Hong Kong



[11] 2118091.6M011

[15] 02-06-2021

[51] Cl. 11-01

[54] 飾物設計

Ornament design

[73] 六福集團有限公司

Luk Fook Holdings Company Limited
Floor 15, 20, 25 & 27, Metropole Square,
No.2 On Yiu Street,
Shatin, New Territories, Hong Kong

[74] Luk Fook Holdings Company Limited (Legal Affairs Department)

Floor 25, Metropole Square,
No.2 On Yiu Street,
Shatin, New Territories, Hong Kong



[11] 2118091.6M012

[15] 02-06-2021

[51] Cl. 11-01

[54] 飾物設計

Ornament design

[73] 六福集團有限公司

Luk Fook Holdings Company Limited

Floor 15, 20, 25 & 27, Metropole Square,

No.2 On Yiu Street,

Shatin, New Territories, Hong Kong

[74] Luk Fook Holdings Company Limited (Legal Affairs Department)

Floor 25, Metropole Square,

No.2 On Yiu Street,

Shatin, New Territories, Hong Kong



[11] 2118091.6M013

[15] 02-06-2021

[51] Cl. 11-01

[54] 飾物設計

Ornament design

[73] 六福集團有限公司

Luk Fook Holdings Company Limited
Floor 15, 20, 25 & 27, Metropole Square,
No.2 On Yiu Street,
Shatin, New Territories, Hong Kong

[74] Luk Fook Holdings Company Limited (Legal Affairs Department)

Floor 25, Metropole Square,
No.2 On Yiu Street,
Shatin, New Territories, Hong Kong



[11] 2118099.3

[15] 03-06-2021

[51] Cl. 9-03

[54] 包裝盒

Packing box

[73] 歐美藥業集團有限公司

香港新界

粉嶺業豐街 13 號

多利工業大廈 4 樓 F 室

[74] 歐美藥業集團有限公司

香港新界

粉嶺業豐街 13 號

多利工業大廈 4 樓 F 室



[11] 2118100.7

[15] 03-06-2021

[51] C1. 9-03

[54] 包裝盒

Packing box

[73] 維多利亞（香港）多元醫療技術有限公司

Victoria (Hong Kong) 3D Medical Technology Company Limited

香港新界

荃灣白田壩街 23-39 號

長豐工業大廈 18 樓 1805 室

[74] 維多利亞（香港）多元醫療技術有限公司

香港新界

荃灣白田壩街 23-39 號

長豐工業大廈 18 樓 1805 室



- [11] 2118101.9
[15] 03-06-2021
[30] 08-12-2020 / EU / 008313548-0001
[51] Cl. 2-04
[54] 童裝襪褲
Tights for children
[73] Belinda Boden
The Barn Farm Street, Fladbury,
WR10 2QD Pershore, Worcestershire, GB,
United Kingdom
[74] China IP Consultants Limited
Flat D, 17/F., Flourish Food Mfg Center,
18 Tai Lee Street,
Yuen Long, N.T., Hong Kong

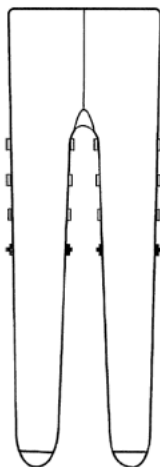

-
- [11] 2118102.1
[15] 03-06-2021
[51] Cl. 23-04
[54] 香薰加濕器
Aroma humidifier
[73] 佰樂居實業有限公司
PARLEX HOUSEHOLD INDUSTRIAL COMPANY LIMITED
香港新界
沙田安群街 1 號
京瑞廣場 2 期 22A
[74] 佰樂居實業有限公司
香港新界
沙田安群街 1 號
京瑞廣場 2 期 22A



[11] 2118103.3

[15] 03-06-2021

[30] 09-12-2020 / EU / 008314488-0001

[51] Cl. 8-08

[54] 夾具
Clamp

[73] Bio Pure Technology Limited
Unit M1, Hazleton Interchange,
Lakesmere Road, Horndean,
Waterlooville, Hampshire PO8 9JU,
United Kingdom

[74] SPRUSON & FERGUSON (HONG KONG) LIMITED
5001 Hopewell Centre,
183 Queen's Road East,
Wan Chai, Hong Kong

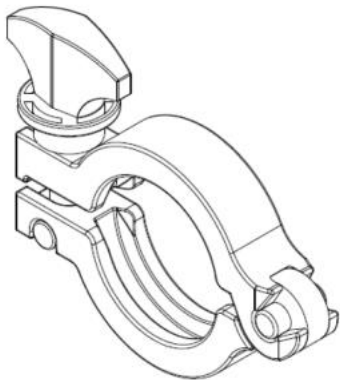

[11] 2118106.0

[15] 04-06-2021

[51] Cl. 7-01

[54] 真空瓶

Vacuum bottle

[73] ZOJIRUSHI CORPORATION

1-20-5, Tenma, Kita-ku,
Osaka, 530-8511,
Japan

[74] HASTINGS & CO

5/F, Gloucester Tower, The Landmark,
11 Pedder Street,
Central, Hong Kong



[11] 2118107.2

[15] 04-06-2021

[51] Cl. 7-01

[54] 杯

Tumbler

[73] ZOJIRUSHI CORPORATION

1-20-5, Tenma, Kita-ku,
Osaka, 530-8511,
Japan

[74] HASTINGS & CO

5/F, Gloucester Tower, The Landmark,
11 Pedder Street,
Central, Hong Kong



[11] 2118108.4

[15] 04-06-2021

[51] Cl. 9-05

[54] 包裝用袋

Packaging bag

[73] KRACIE HOME PRODUCTS, LTD.

20-20, Kaigan 3-chome,

Minato-ku, Tokyo 108-0022,

Japan

[74] UNION PATENT SERVICE CENTRE

Units E-F, 20th Floor, Neich Tower,

128 Gloucester Road,

Hong Kong



[11] 2118109.6

[15] 04-06-2021

[51] Cl. 9-03

[54] 包裝用盒

Packaging box

- [73] KRACIE HOME PRODUCTS, LTD.
20-20, Kaigan 3-chome,
Minato-ku, Tokyo 108-0022,
Japan
- [74] UNION PATENT SERVICE CENTRE
Units E-F, 20th Floor, Neich Tower,
128 Gloucester Road,
Hong Kong



-
- [11] 2118110.8
- [15] 04-06-2021
- [51] Cl. 9-03
- [54] 包裝用盒
Packaging box
- [73] KRACIE HOME PRODUCTS, LTD.
20-20, Kaigan 3-chome,
Minato-ku, Tokyo 108-0022,
Japan
- [74] UNION PATENT SERVICE CENTRE
Units E-F, 20th Floor, Neich Tower,
128 Gloucester Road,
Hong Kong



[11] 2118111.0

[15] 04-06-2021

[51] Cl. 9-03

[54] 包裝用盒

Packaging box

[73] KRACIE HOME PRODUCTS, LTD.

20-20, Kaigan 3-chome,
Minato-ku, Tokyo 108-0022,
Japan

[74] UNION PATENT SERVICE CENTRE

Units E-F, 20th Floor, Neich Tower,
128 Gloucester Road,
Hong Kong



[11] 2118112.2

[15] 04-06-2021

[51] Cl. 9-03

[54] 包裝用盒

Packaging box

[73] KRACIE HOME PRODUCTS, LTD.

20-20, Kaigan 3-chome,
Minato-ku, Tokyo 108-0022,
Japan

[74] UNION PATENT SERVICE CENTRE

Units E-F, 20th Floor, Neich Tower,
128 Gloucester Road,
Hong Kong



[11] 2118113.4

[15] 04-06-2021

[51] Cl. 9-03

[54] 包裝用盒

Packaging box

[73] KRACIE HOME PRODUCTS, LTD.

20-20, Kaigan 3-chome,
Minato-ku, Tokyo 108-0022,
Japan

[74] UNION PATENT SERVICE CENTRE

Units E-F, 20th Floor, Neich Tower,
128 Gloucester Road,
Hong Kong



[11] 2118114.6

[15] 04-06-2021

[51] Cl. 9-03

[54] 用於包裝的紙板

Cardboard for packaging

[73] KRACIE HOME PRODUCTS, LTD.

20-20, Kaigan 3-chome,
Minato-ku, Tokyo 108-0022,
Japan

[74] UNION PATENT SERVICE CENTRE

Units E-F, 20th Floor, Neich Tower,
128 Gloucester Road,
Hong Kong



[11] 2118115.9

[15] 04-06-2021

[51] Cl. 9-03

[54] 包裝用盒

Packaging box

[73] KRACIE HOME PRODUCTS, LTD.

20-20, Kaigan 3-chome,
Minato-ku, Tokyo 108-0022,
Japan

[74] UNION PATENT SERVICE CENTRE

Units E-F, 20th Floor, Neich Tower,
128 Gloucester Road,
Hong Kong



[11] 2118116.1

[15] 04-06-2021

[51] Cl. 9-03

[54] 用於包裝的紙板

Cardboard for packaging

[73] KRACIE HOME PRODUCTS, LTD.

20-20, Kaigan 3-chome,
Minato-ku, Tokyo 108-0022,
Japan

[74] UNION PATENT SERVICE CENTRE

Units E-F, 20th Floor, Neich Tower,
128 Gloucester Road,
Hong Kong



[11] 2118117.3

[15] 04-06-2021

[51] Cl. 9-05

[54] 包裝用袋
Packaging bag

[73] KRACIE HOME PRODUCTS, LTD.
20-20, Kaigan 3-chome,
Minato-ku, Tokyo 108-0022,
Japan

[74] UNION PATENT SERVICE CENTRE
Units E-F, 20th Floor, Neich Tower,
128 Gloucester Road,
Hong Kong



[11] 2118118.5

[15] 04-06-2021

[30] 04-12-2020 / JP / 026238 of 2020

[51] Cl. 23-01

[54] 淨水器

Water purifier

[73] TORAY INDUSTRIES, INC.

1-1, Nihonbashi-muromachi 2-chome,

Chuo-ku, Tokyo 103-8666,

Japan

[74] CHINA PATENT AGENT (HONG KONG) LIMITED

22/F, Great Eagle Centre,

23 Harbour Road,

Wanchai, Hong Kong

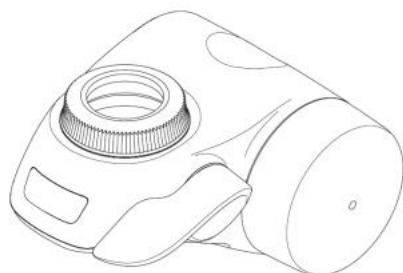

[11] 2118119.7

[15] 04-06-2021

[30] 04-12-2020 / CN / 202030747278.1

[51] Cl. 14-03

[54] 電視

Television

[73] 北京小米移動軟件有限公司

BEIJING XIAOMI MOBILE SOFTWARE CO., LTD.

中國內地

北京市海澱區西二旗中路

33 號院 6 號樓 8 層 018 號

[74] 香港派特恩知識產權代理有限公司

香港上環

永樂街 121-125 號

永達商業大廈 10 樓 C 室

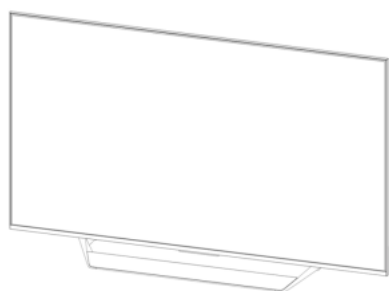

[11] 2118121.1M001

[15] 07-06-2021

[30] 07-01-2021 / CN / 202130008975.X

[51] Cl. 2-01

[54] 罩杯

Bra cup

[73] 安莉芳(中國)服裝有限公司

Embry (China) Garments Ltd.

5th Floor East, Block A, Cuishan Industrial Area,
2063 Jindaotian Road; 14th Floor West, 17th and
18th Floors, Block B, CMEC Plaza, No. 1028 Buji
Road, Dongxiao Street, Luohu District, Shenzhen, China

[74] SPRUSON & FERGUSON (HONG KONG) LIMITED

5001 Hopewell Centre,
183 Queen's Road East,
Wan Chai, Hong Kong



[11] 2118121.1M002

[15] 07-06-2021

[30] 07-01-2021 / CN / 202130008998.0

[51] Cl. 2-01

[54] 罩杯

Bra cup

[73] 安莉芳(中國)服裝有限公司

Embry (China) Garments Ltd.

5th Floor East, Block A, Cuishan Industrial Area,
2063 Jindaotian Road; 14th Floor West, 17th and
18th Floors, Block B, CMEC Plaza, No. 1028 Buji
Road, Dongxiao Street, Luohu District, Shenzhen, China

[74] SPRUSON & FERGUSON (HONG KONG) LIMITED

5001 Hopewell Centre,
183 Queen's Road East,
Wan Chai, Hong Kong

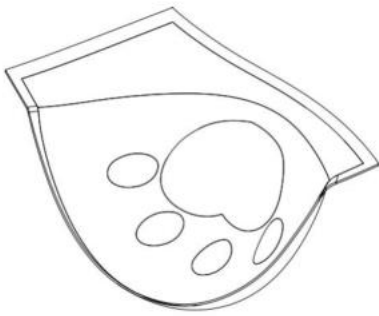

[11] 2118121.1M003

[15] 07-06-2021

[30] 07-01-2021 / CN / 202130008992.3

[51] Cl. 2-01

[54] 罩杯

Bra cup

[73] 安莉芳(中國)服裝有限公司

Embry (China) Garments Ltd.

5th Floor East, Block A, Cuishan Industrial Area,
2063 Jindaotian Road; 14th Floor West, 17th and
18th Floors, Block B, CMEC Plaza, No. 1028 Buji
Road, Dongxiao Street, Luohu District, Shenzhen, China

[74] SPRUSON & FERGUSON (HONG KONG) LIMITED

5001 Hopewell Centre,
183 Queen's Road East,
Wan Chai, Hong Kong



[11] 2118122.3M001

[15] 07-06-2021

[30] 12-01-2021 / US / 29/765,818

[51] Cl. 13-03

[54] 電子器件殼體
Electronic housing

[73] 高準有限公司
Micro Motion, Inc.
7070 Winchester Circle,
Boulder, Colorado, 80301,
United States of America

[74] UNITALEN ATTORNEYS AT LAW LIMITED
Rm 1201, 12/F, Golden Era Plaza,
39-55 Sai Yee St,
Mongkok, Kln, Hong Kong



[11] 2118122.3M002

[15] 07-06-2021

- [30] 12-01-2021 / US / 29/765,818
- [51] Cl. 13-03
- [54] 電子器件殼體
Electronic housing
- [73] 高準有限公司
Micro Motion, Inc.
7070 Winchester Circle,
Boulder, Colorado, 80301,
United States of America
- [74] UNITALEN ATTORNEYS AT LAW LIMITED
Rm 1201, 12/F, Golden Era Plaza,
39-55 Sai Yee St,
Mongkok, Kln, Hong Kong



-
- [11] 2118122.3M003
- [15] 07-06-2021
- [30] 12-01-2021 / US / 29/765,818
- [51] Cl. 13-03
- [54] 電子器件殼體
Electronic housing
- [73] 高準有限公司
Micro Motion, Inc.
7070 Winchester Circle,
Boulder, Colorado, 80301,
United States of America
- [74] UNITALEN ATTORNEYS AT LAW LIMITED
Rm 1201, 12/F, Golden Era Plaza,
39-55 Sai Yee St,
Mongkok, Kln, Hong Kong



[11] 2118123.5

[15] 07-06-2021

[30] 30-12-2020 / US / 29/652,890

[51] Cl. 3-01

[54] 耳塞式耳機收納盒

Earbud headset case

[73] Skullcandy, Inc.

6301 N. Landmark Dr.,

Park City, UT 84098,

United States of America

[74] CLT PATENT & TRADEMARK (H.K.) LIMITED

Unit 09, 34/F., Office Tower, Convention Plaza,

No. 1 Harbour Road,

Wanchai, Hong Kong

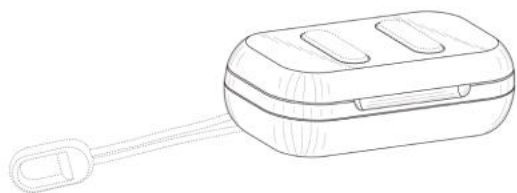

[11] 2118124.7

[15] 07-06-2021

[30] 07-12-2020 / CN / 202030750811.X

[51] Cl. 14-01

[54] 耳機

Earphone

- [73] 北京小米移動軟件有限公司
Beijing Xiaomi Mobile Software Co., Ltd.
中國內地
北京市海澱區西二旗中路 33 號院
6 號樓 8 層 018 號
- [74] 隆天專利商標代理有限公司
香港長沙灣
青山道 485 號
九龍廣場 10 樓 11 室



-
- [11] 2118126.2M001
- [15] 08-06-2021
- [30] 12-01-2021 / US / 29/765,823
- [51] Cl. 13-03
- [54] 電子器件殼體
Electronic housing
- [73] 高準有限公司
Micro Motion, Inc.
7070 Winchester Circle,
Boulder, Colorado, 80301,
United States of America
- [74] UNITALEN ATTORNEYS AT LAW LIMITED
Rm 1201, 12/F, Golden Era Plaza,
39-55 Sai Yee St,
Mongkok, Kln, Hong Kong



[11] 2118126.2M002

[15] 08-06-2021

[30] 12-01-2021 / US / 29/765,823

[51] Cl. 13-03

[54] 電子器件殼體

Electronic housing

[73] 高準有限公司

Micro Motion, Inc.

7070 Winchester Circle,

Boulder, Colorado, 80301,

United States of America

[74] UNITALEN ATTORNEYS AT LAW LIMITED

Rm 1201, 12/F, Golden Era Plaza,

39-55 Sai Yee St,

Mongkok, Kln, Hong Kong

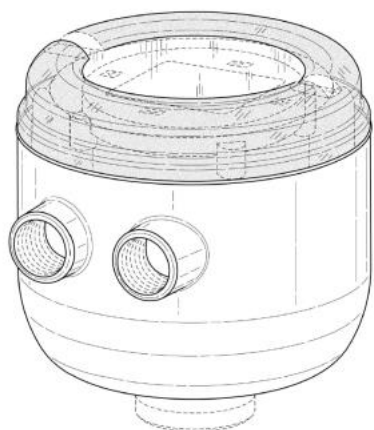



香港特別行政區政府知識產權署外觀設計註冊處

The Government of the Hong Kong Special Administrative Region

Designs Registry, Intellectual Property Department

根據註冊外觀設計條例第 28 條，下列註冊外觀設計因未繳續期費而停止有效。

各組記項按註冊外觀設計停止有效日期及註冊編號先後次序排列。

Registered designs ceased through non-payment of renewal fees under section 28 of the Registered Designs Ordinance. Entries are listed below under their expiry dates.

02-05-2021 - 05-05-2021**02-05-2021**1600823.3
1600825.8
1600827.2
1600829.6
1600834.6
1600835.9M001
1600835.9M002**03-05-2021**1100751.5
1600838.5
1600842.3
1600843.5M001
1600843.5M002
1600843.5M003**04-05-2021**1100759.2M001
1600848.6M002
1600848.6M003
1600850.0
1600851.2M001
1600851.2M002
1600851.2M003
1600851.2M004
1600851.2M005
1600851.2M006
1600851.2M007
1600851.2M008
1600851.2M009
1600851.2M010
1600853.6
1600855.1M001**05-05-2021**1100769.3
1100771.7M001
1100771.7M002
1600862.5M001
1600862.5M002
1600862.5M003
1600862.5M004
1600863.7
1600865.2
1600866.4



香港特別行政區政府知識產權署外觀設計註冊處

The Government of the Hong Kong Special Administrative Region

Designs Registry, Intellectual Property Department

根據註冊外觀設計規則第 31 條刪除的註冊外觀設計。各組記項按註冊外觀設計刪除日期及註冊編號先後次序排列。

Registered designs removed under section 31 of the Registered Designs Rules. Entries are listed below under their removal dates.

02-07-2021 - 08-07-2021

02-07-2021	1502368.8	1502382.7M009
1502353.6	1502369.0	1502384.1M001
1502355.1		1502384.1M002
1502357.5	05-07-2021	1502384.1M003
1502358.7M001	1002027.1	1502384.1M004
1502358.7M002	1002028.3	1502384.1M005
1502360.1	1502370.2	1502384.1M006
1502361.3	1502374.0	
	1502375.3	08-07-2021
03-07-2021	1502376.5	1502387.8
0502641.6M001		1502388.0
0502641.6M002	06-07-2021	
1002004.2	1002034.5	
	1502378.9	
04-07-2021	1502379.1	
1002010.5		
1002011.7M002	07-07-2021	
1002012.9M001	1002036.0	
1002012.9M002	1002037.2	
1002012.9M003	1002042.2	
1002012.9M004	1100227.4	
1002012.9M005	1100228.6	
1002012.9M006	1502381.5M001	
1002012.9M007	1502381.5M002	
1002012.9M008	1502381.5M003	
1002012.9M009	1502381.5M004	
1002012.9M010	1502382.7M001	
1002012.9M011	1502382.7M002	
1002012.9M012	1502382.7M003	
1002012.9M013	1502382.7M004	
1002012.9M014	1502382.7M005	
1502362.5	1502382.7M006	
1502367.6M001	1502382.7M007	
1502367.6M003	1502382.7M008	



香港特別行政區政府知識產權署外觀設計註冊處

The Government of the Hong Kong Special Administrative Region

Designs Registry, Intellectual Property Department

根據註冊外觀設計條例第 76 條，更正已提交文件中的錯誤

Correction of errors in filed documents under section 76 of the Registered Designs Ordinance

下列在 30.04.2021 官方公報刊登的更正錯誤的請求已在 02.07.2021 獲准許

The following requests for correction of error advertised in the official journal on 30.04.2021 were allowed on 02.07.2021

[21] 2117513.2M001

[30] 01.08.2020 / EU / 008062731

[21] 2117663.9

[71] 香港職業治療學會有限公司

Hong Kong Occupational Therapy Association Limited

[21] 2117664.1M001-M004

[71] 香港職業治療學會有限公司

Hong Kong Occupational Therapy Association Limited