

香港知識產權公報

Hong Kong Intellectual Property Journal

2020 年 1 月 24 日

24 January 2020

目錄 Contents

根據註冊外觀設計條例第 25 條註冊的外觀設計

Designs Registered under section 25 of the Registered Designs Ordinance

按註冊編號排列

Arranged by Registration Number

根據註冊外觀設計條例(第 522 章)公布的其他公告

Other Notices Published under the Registered Designs Ordinance (Cap. 522)

根據註冊外觀設計條例第 28 條，註冊外觀設計因未繳續期費而停止有效

Registered designs ceased through non-payment of renewal fees under section 28 of the Registered Designs Ordinance

根據註冊外觀設計規則第 31 條刪除的註冊外觀設計

Registered designs removed under section 31 of the Registered Designs Rules

勘誤

Corrigendu

以下事項沒有記錄

No Records for the Following Matters

根據註冊外觀設計條例第 30 條放棄的外觀設計的註冊

Surrender of Registration of Design under section 30 of the Registered Designs Ordinance

根據註冊外觀設計規則第 37 條，向處長作出轉介

Reference to Registrar under section 37 of the Registered Designs Rules

根據註冊外觀設計條例第 45 條，撤銷註冊

Revocation of Registration under section 45 of the Registered Designs Ordinance

根據註冊外觀設計規則第 46 條，向法院作出轉介

Reference to Court under section 46 of the Registered Designs Rules

根據註冊外觀設計規則第 63 條對不符合規定之處作出糾正
Rectification of Irregularities under section 63 of the Registered Designs Rules

根據註冊外觀設計條例第 66 條，糾正註冊紀錄冊
Rectification of Register under section 66 of the Registered Designs Ordinance

根據註冊外觀設計條例第 67 條，更正註冊紀錄冊內的錯誤
Correction of Errors in Register under section 67 of the Registered Designs Ordinance

根據註冊外觀設計條例第 67 及 76 條，更正註冊紀錄冊內及已提交文件中的錯誤
Correction of Errors in Register and in Filed Documents under sections
67 and 76 of the Registered Designs Ordinance

根據註冊外觀設計條例第 76 條，更正已提交文件中的錯誤
Correction of Errors in Filed Documents under section 76 of the Registered Designs
Ordinance

註冊外觀設計公告註釋

Notes on advertisements of registration of designs

方括號表示下列資料：

Square brackets indicate the following data：

- [11] 註冊編號 Registration number / 聯合王國註冊編號 United Kingdom registration number
- [15] 註冊日期 Registration date / 當作註冊日期 Deemed registration date / 聯合王國註冊日期 United Kingdom registration date
- [17] 註冊有效期屆滿日期 Expiry date of the period of registration
- [22] 提交日期 Filing date / 當作提交日期 Deemed filing date / 聯合王國提交日期 United Kingdom filing date
- [30] 聲稱享有的優先權 (提交日期 / 巴黎公約國或世界貿易組織成員 / 申請編號) Priority claimed (filing date / Paris Convention country or WTO member / application number)
- [51] 國際外觀設計分類號 (洛迦諾分類號) International Classification of designs (Locarno Classification)
- [54] 物品 Article
- [55] 外觀設計的表述 Representation of the design
- [62] 分開前的申請編號及提交日期 Application number before division and filing date
- [66] 過往註冊的聯繫外觀設計註冊編號 / 日期 Registration No. / Date of Previous Registration for Association
- [72] 設計人 Designer

[73] 擁有人姓名和地址 Name and address of the owner

[74] 代理人 Agent / 送達地址 Address for service



香港特別行政區政府知識產權署外觀設計註冊處

The Government of the Hong Kong Special Administrative Region

Designs Registry, Intellectual Property Department

根據註冊外觀設計條例第25條註冊的外觀設計

Designs registered under section 25 of the Registered Designs Ordinance

按註冊編號排列

Arranged by Registration Number

[11] 1913118.6

[15] 01-03-2019

[30] 24-01-2019 / KR / 30-2019-0003616

[51] Cl. 7-07

[54] 可攜帶式水袋

Portable Water Bag

[73] SILLYMANN Co., Ltd.

116, Donyu 2-ro, Paju-eup,

Paju-si, Gyeonggi-do,

KOREA, REPUBLIC OF

[74] STANDARD TRADEMARK REGISTRATION SERVICE LIMITED

Suite 503, Tower 2, Lippo Centre,

Queensway,

HONG KONG

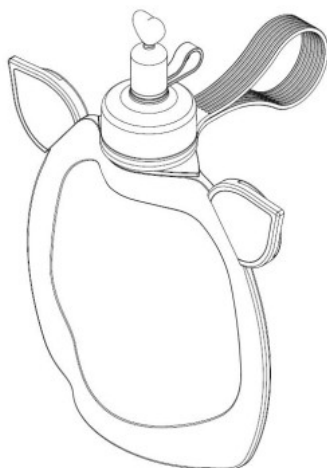

[11] 1913584.3M001

[15] 06-05-2019

[51] Cl. 14-03

[54] 智能定位裝置
Smart GPS tracking

[73] 何志偉
HO CHI WAI
17/F, B5, Goodwill Industrial Building,
36-44 Pak Tin Par Street, Tsuen Wan
HONG KONG

[74] HO CHI WAI
17/F, B5, Goodwill Industrial Building,
36-44 Pak Tin Par Street, Tsuen Wan,
HONG KONG

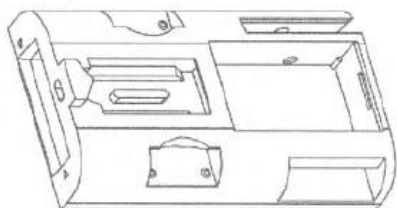

[11] 1913584.3M002

[15] 06-05-2019

[51] Cl. 14-03

[54] 智能定位裝置
Smart GPS tracking

[73] 何志偉
HO CHI WAI
17/F, B5, Goodwill Industrial Building,
36-44 Pak Tin Par Street, Tsuen Wan
HONG KONG

[74] HO CHI WAI
17/F, B5, Goodwill Industrial Building,
36-44 Pak Tin Par Street, Tsuen Wan,
HONG KONG

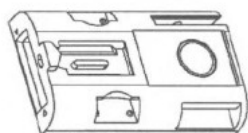

- [11] 1913584.3M003
[15] 06-05-2019
[51] Cl. 14-03
[54] 智能定位裝置
Smart GPS tracking
[73] 何志偉
HO CHI WAI
17/F, B5, Goodwill Industrial Building,
36-44 Pak Tin Par Street, Tsuen Wan
HONG KONG
[74] HO CHI WAI
17/F, B5, Goodwill Industrial Building,
36-44 Pak Tin Par Street, Tsuen Wan,
HONG KONG

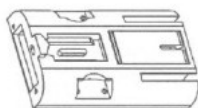

-
- [11] 1913641.5M001
[15] 16-05-2019
[30] 21-11-2018 / CN / 201830661930.0
[51] Cl. 15-05
[54] 洗碗機
Dishwasher
[73] 九陽股份有限公司
JOYOUNG COMPANY LIMITED
中國內地 山東省濟南
市槐蔭區 美裡路 999
號
[74] 集佳知識產權有限公司
香港九龍旺角
洗衣街 39-55 號
金雞廣場 12 層 1201 室



[11] 1913641.5M002

[15] 16-05-2019

[30] 21-11-2018 / CN / 201830661930.0

[51] C1. 15-05

[54] 洗碗機

Dishwasher

[73] 九陽股份有限公司

JOYOUNG COMPANY LIMITED

中國內地 山東省濟南

市槐蔭區 美裡路 999

號

[74] 集佳知識產權有限公司

香港九龍旺角

洗衣街 39-55 號

金雞廣場 12 層 1201 室



[11] 1913642.7M001

[15] 16-05-2019

[30] 14-12-2018 / CN / 201830726793.4

[51] Cl. 15-05

[54] 洗碗機

Dish washer

[73] 九陽股份有限公司

JOYOUNG COMPANY LIMITED

中國內地 山東省濟南

市槐蔭區 美裡路 999

號

[74] 集佳知識產權有限公司

香港九龍旺角

洗衣街 39-55 號

金雞廣場 12 層 1201 室



[11] 1913642.7M002

[15] 16-05-2019

[30] 14-12-2018 / CN / 201830726793.4

[51] Cl. 15-05

[54] 洗碗機

Dish washer

[73] 九陽股份有限公司

JOYOUNG COMPANY LIMITED

中國內地

山東省濟南市槐蔭區

美裡路 999 號

[74] 集佳知識產權有限公司

香港九龍旺角

洗衣街 39-55 號

金雞廣場 12 層 1201 室



[11] 1913643.9

[15] 16-05-2019

[30] 16-11-2018 / KR / 30-2018-0053247

[51] Cl. 24-02

[54] 人體用藥物注射器

Drug injection device for human

[73] 365 天天美好有限公司

NICEDAY365.CO.,LTD

#804,

242 Digital-ro, Guro-gu, Seoul,

KOREA, REPUBLIC OF

[74] ACCOLADE IP LIMITED

10/F, Fu Fai Comm. Ctr.,

27 Hillier Street, Sheung Wan,

HONG KONG



[11] 1913650.4

[15] 16-05-2019

[30] 06-12-2018 / CN / 201830703104.8

[51] C1. 26-02

[54] 充電燈

Rechargeable light

[73] 全怡藝科技(深圳)有限公司

中國內地

深圳市寶安區石岩街道 石新社區宏發工業園(宏發電
子廠)17棟四樓

[74] 崔丹

香港

德輔道西 442 號

美新樓 23 樓 06 室

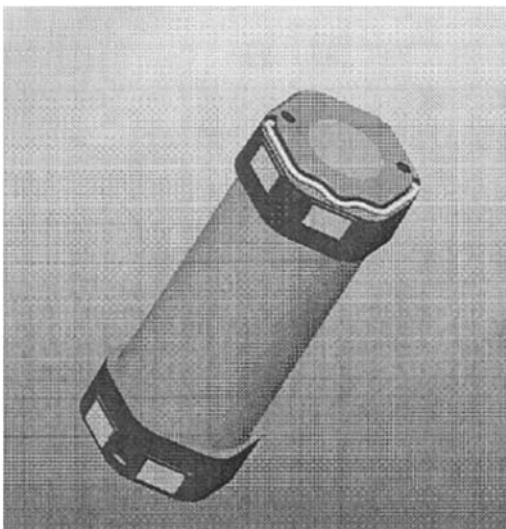

[11] 1913677.1

[15] 20-05-2019

[30] 27-03-2019 / KR / 30-2019-0014130

[51] Cl. 6-09

[54] 骨盆矯正坐墊

Cushion for pelvis correction

[73] BULLSONE CO., LTD.

6F, KAIT Tower, 306, Teheran-ro

Gangnam-gu, Seoul 06210

KOREA, REPUBLIC OF

[74] MARKS & CLERK

Level 9, Cyberport 1

100 Cyberport Road, Pok Fu Lam

HONG KONG



[11] 1913714.0

[15] 23-05-2019

[30] 03-12-2018 / US / 29/672,034

[51] Cl. 7-04

[54] 柑橘榨汁器

Citrus juicer

[73] Helen of Troy Limited

The Phoenix Centre

George Street, Belleville, St. Michael

[74] BIRD & BIRD

4/F Three Pacific Place

1 Queen's Road East

HONG KONG

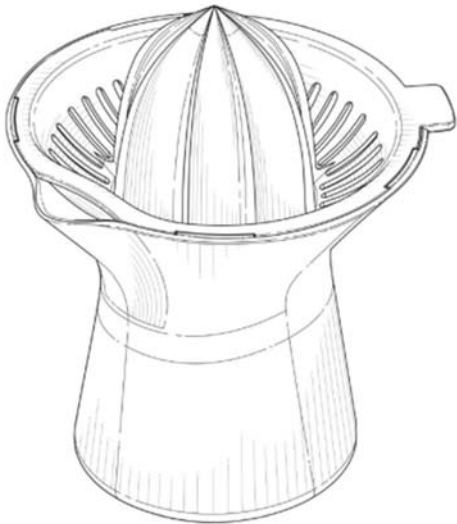

[11] 1913715.3

[15] 23-05-2019

[30] 03-12-2018 / US / 29/672,036

[51] Cl. 7-04

[54] 柑橘榨汁器

Citrus juicer

[73] Helen of Troy Limited

The Phoenix Centre

George Street, Belleville, St. Michael

[74] BIRD & BIRD

4/F Three Pacific Place

1 Queen's Road East

HONG KONG

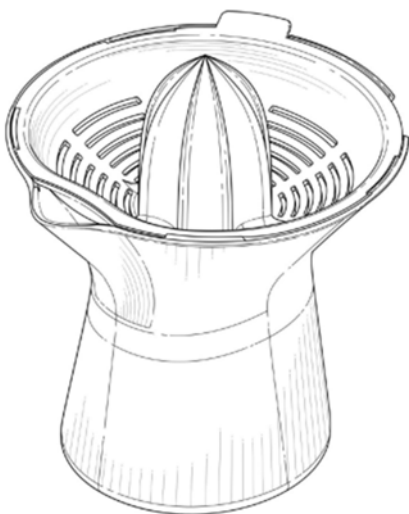

[11] 1913785.0

[15] 31-05-2019

[30] 02-12-2018 / US / 29/672,029

[51] Cl. 9-07

[54] 瓶蓋

Bottle lid

[73] Helen of Troy Limited

The Phoenix Centre

George Street, Belleville, St. Michael

[74] BIRD & BIRD

4/F Three Pacific Place

1 Queen's Road East

HONG KONG

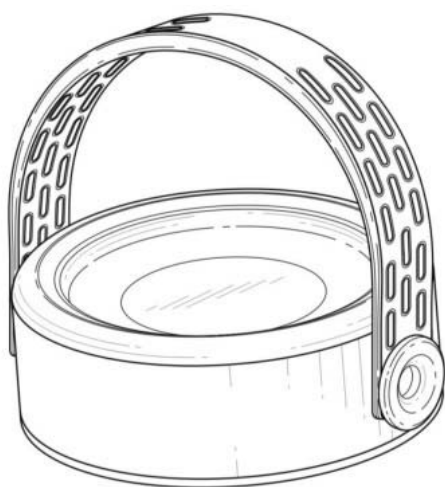

[11] 1913786.2

[15] 31-05-2019

[30] 02-12-2018 / US / 29/672,030

[51] Cl. 7-99

[54] 瓶帶扣

Bottle strap lug

[73] Helen of Troy Limited

The Phoenix Centre

George Street, Belleville, St. Michael

[74] BIRD & BIRD

4/F Three Pacific Place

1 Queen's Road East

HONG KONG

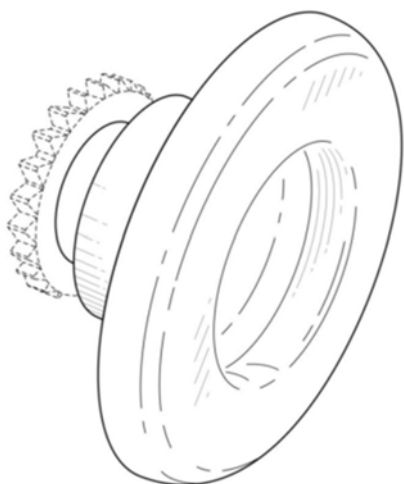

[11] 1913867.4

[15] 05-06-2019

[51] Cl. 11-02

[54] 裝飾物

Ornament

[73] 老鋪黃金(香港)有限公司

LAO PU (HONG KONG) COMPANY LIMITED

Room 801-2, 8/F, Easey Commercial Building,

253-261 Hennessy Road, Wanchai,

HONG KONG

[74] SF LAWYERS

UNIT 1125-1127, PRINCE'S BUILDING,

10 CHATER ROAD, CENTRAL,

HONG KONG



[11] 1913952.4

[15] 12-06-2019

[30] 24-12-2018 / KR / 30-2018-0061242

[51] Cl. 27-07

[54] 電子煙

Electronic cigarette

[73] KT&G Corporation

71, Beotkkot-gil,

Daedeok-gu, Daejeon

KOREA, REPUBLIC OF

[74] Luo & Jia Intellectual Property Limited

9B, Cheong Tai Commercial Building,

66 Wing Lok Street, Sheung Wan,

HONG KONG



[11] 1913954.8

[15] 12-06-2019

[30] 24-12-2018 / KR / 30-2018-0061236

[51] Cl. 27-07

[54] 電子煙

Electronic cigarette

[73] KT&G Corporation

71, Beotkkot-gil,

Daedeok-gu, Daejeon

KOREA, REPUBLIC OF

[74] Luo & Jia Intellectual Property Limited

9B, Cheong Tai Commercial Building,

66 Wing Lok Street, Sheung Wan,

HONG KONG



[11] 1913955.1

[15] 12-06-2019

[30] 29-01-2019 / KR / 30-2019-0004332

[51] Cl. 27-07

[54] 電子煙

Electronic cigarette

[73] KT&G Corporation

71, Beotkkot-gil,

Daedeok-gu, Daejeon

KOREA, REPUBLIC OF

[74] Luo & Jia Intellectual Property Limited

9B, Cheong Tai Commercial Building,

66 Wing Lok Street, Sheung Wan,

HONG KONG



[11] 1913988.0

[15] 14-06-2019

[30] 13-03-2019 / CN / 201930102237.4

[51] Cl. 23-01

[54] 發光二極管軟水香氛花灑頭

LED soft-water aroma shower
head

[73] 杭州怡水科技有限公司

Hangzhou Enjoywater Technology Co., Ltd.

中國內地 浙江省杭州市餘杭區倉前

街道歐 美金融城 T2 英國中心

2901 室

[74] 中港知識產權有限公司

香港

港灣道 1 號

會展廣場辦公大樓 30 樓 3011 室

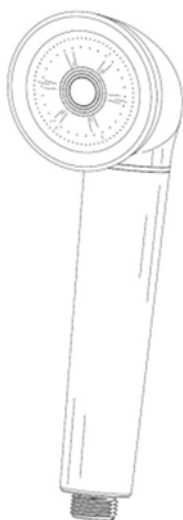

[11] 1913990.4

[15] 14-06-2019

[30] 14-12-2018 / FR / 2018-5574

[51] Cl. 2-04

[54] 鞋

Shoe

[73] LOUIS VUITTON MALLETIER

2 rue du Pont-Neuf

75001 Paris

FRANCE

[74] BAKER & MCKENZIE

14TH FLOOR, ONE TAIKOO PLACE,

979 KING'S ROAD, QUARRY BAY,
HONG KONG



[11] 1913991.6

[15] 14-06-2019

[30] 14-12-2018 / FR / 2018-5574

[51] Cl. 2-04

[54] 鞋

Shoe

[73] LOUIS VUITTON MALLETIER

2 rue du Pont-Neuf

75001 Paris

FRANCE

[74] BAKER & MCKENZIE

14TH FLOOR, ONE TAIKOO PLACE,

979 KING'S ROAD, QUARRY BAY,

HONG KONG



[11] 1914000.7

[15] 14-06-2019

[30] 14-12-2018 / FR / 2018-5578

[51] Cl. 3-01

[54] 袋

Bag

[73] LOUIS VUITTON MALLETIER

2 rue du Pont-Neuf

75001 Paris

FRANCE

[74] BAKER & MCKENZIE

14TH FLOOR, ONE TAIKOO PLACE,

979 KING'S ROAD, QUARRY BAY,

HONG KONG



[11] 1914030.0

[15] 19-06-2019

[51] Cl. 6-04

[54] 方形雨傘除水器

Square umbrella dryer

[73] 林曉文以三協貿易公司之名營業

Lam Hui Man, Simon trading as Trinity Trading Company

香港

新蒲崗雙喜街19號 雙喜工

業大廈2樓A室

[74] 三協貿易公司

香港

新蒲崗雙喜街19號 雙喜工

業大廈2樓A室



[11] 1914047.6

[15] 24-06-2019

[30] 26-12-2018 / CN / 201830758005.X

[51] Cl. 14-01

[54] 耳機

Earphone

[73] 索尼公司

SONY CORPORATION

日本東京都

1-7-1 KONAN, MINATO-KU

[74] 集佳知識產權有限公司

香港九龍旺角

洗衣街 39-55 號

金雞廣場 12 層 1201 室

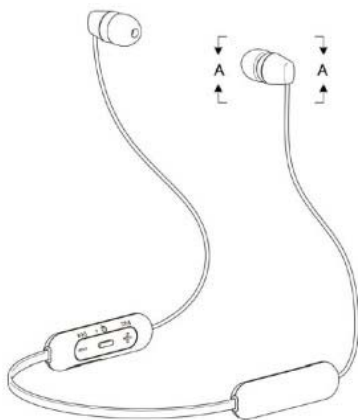

[11] 1914140.3

[15] 05-07-2019

[51] Cl. 25-04

[54] 平台梯

Platform ladder

[73] 天津市金錨家居用品有限公司

Tianjin Jinmao Household Products Co., Ltd.

中國內地 天

津市北辰區

大張莊鎮北孫莊村南津圍公路 980 號

[74] HONG KONG DECENT INTELLECTUAL PROPERTY AGENT LIMITED

香港

香港皇后大道中 222 號

啟煌商業大廈 101 室



[11] 1914160.5

[15] 09-07-2019

[51] Cl. 9-05

[54] 急凍三文魚件包裝袋

Packaging bag of frozen salmon portion

[73] Leader Marine Products Trading Ltd.

香港

香港仔田灣海旁道 7 號 興偉工業

中心 6 樓 613B 室

[74] Leader Marine Products Trading Ltd.

香港

香港仔田灣海旁道 7 號 興偉工業

中心 6 樓 613B 室

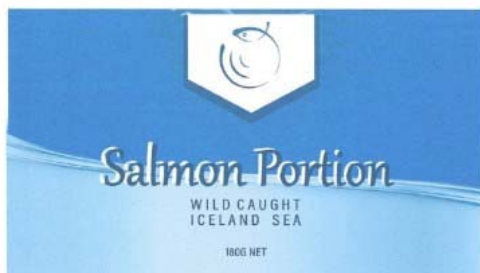

[11] 1914162.9

[15] 09-07-2019

[51] Cl. 9-05

[54] 急凍吞拿魚扒包裝袋

Packaging bag of frozen tuna steak

[73] Onric Development Company Ltd.

香港

香港仔田灣海旁道 7 號 興偉工業

中心 6 樓 613B 室

[74] Onric Development Company Ltd.

香港

香港仔田灣海旁道 7 號 興偉工業

中心 6 樓 613B 室



[11] 1914164.3

[15] 09-07-2019

[51] Cl. 9-05

[54] 急凍龍躉扒包裝袋

Packaging bag of frozen giant grouper steak

[73] Onric Development Company Ltd.

香港

香港仔田灣海旁道 7 號 興偉工業

中心 6 樓 613B 室

[74] Onric Development Company Ltd.

香港

香港仔田灣海旁道 7 號 興偉工業

中心 6 樓 613B 室

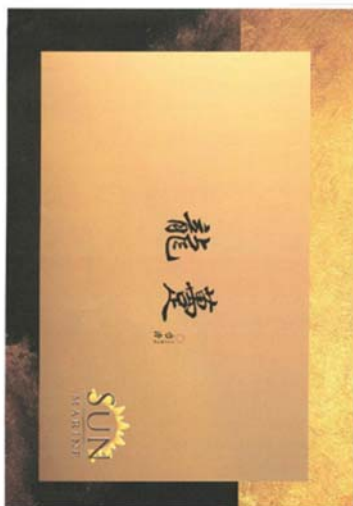

[11] 1914170.6M001

[15] 09-07-2019

[30] 11-01-2019 / MC, RU, SG, CH, GB, US, EU, JP, KR / DM/200745

[51] Cl. 26-05

[54] 燈

Lamp

[73] COMPAGNIE DES CRISTALLERIES DE SAINT-LOUIS Société par actions
simplifiée

F-57620 SAINT-LOUIS LES BITCHE

FRANCE

[74] DEACONS

5th Floor, Alexandra House

Central

HONG KONG



[11] 1914170.6M002

[15] 09-07-2019

[30] 11-01-2019 / MC, RU, SG, CH, GB, US, EU, JP, KR / DM/200745

[51] Cl. 26-05

[54] 壁燈

Wall lamp

[73] COMPAGNIE DES CRISTALLERIES DE SAINT-LOUIS Société par actions
simplifiée

F-57620 SAINT-LOUIS LES BITCHE

FRANCE

[74] DEACONS

5th Floor, Alexandra House

Central

HONG KONG



[11] 1914170.6M003

[15] 09-07-2019

[30] 11-01-2019 / MC, RU, SG, CH, GB, US, EU, JP, KR / DM/200745

[51] Cl. 26-05

[54] 壁燈

Wall lamp

[73] COMPAGNIE DES CRISTALLERIES DE SAINT-LOUIS Société par actions
simplifiée

F-57620 SAINT-LOUIS LES BITCHE

FRANCE

[74] DEACONS

5th Floor, Alexandra House

Central

HONG KONG



[11] 1914170.6M004

[15] 09-07-2019

[30] 11-01-2019 / MC, RU, SG, CH, GB, US, EU, JP, KR / DM/200745

[51] Cl. 26-05

[54] 壁燈

Wall lamp

[73] COMPAGNIE DES CRISTALLERIES DE SAINT-LOUIS Société par actions
simplifiée

F-57620 SAINT-LOUIS LES BITCHE

FRANCE

[74] DEACONS

5th Floor, Alexandra House

Central

HONG KONG



[11] 1914170.6M005

[15] 09-07-2019

[30] 11-01-2019 / MC, RU, SG, CH, GB, US, EU, JP, KR / DM/200745

[51] Cl. 26-05

[54] 燈裝置

Lighting Device

[73] COMPAGNIE DES CRISTALLERIES DE SAINT-LOUIS Société par actions
simplifiée

F-57620 SAINT-LOUIS LES BITCHE
FRANCE

[74] DEACONS

5th Floor, Alexandra House
Central
HONG KONG

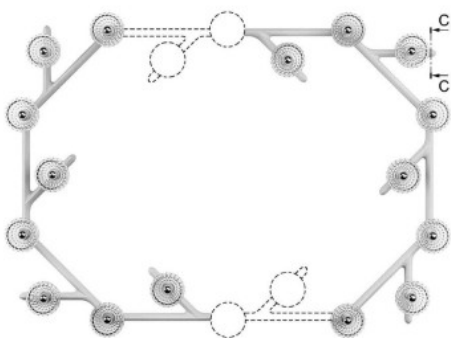

[11] 1914261.9M001

[15] 17-07-2019

[30] 17-01-2019 / GB / 6052306

[51] Cl. 3-01

[54] 手袋

Handbag

[73] STRATHBERRY LIMITED

4 WALKER STREET
EDINBURGH EH3 7LA
UNITED KINGDOM

[74] CHINA PATENT AGENT (HONG KONG) LIMITED

22/F, Great Eagle Centre, 23 Harbour Road, Wanchai
HONG KONG



[11] 1914261.9M002

[15] 17-07-2019

[30] 17-01-2019 / GB / 6052309

[51] Cl. 3-01

[54] 手袋

Handbag

[73] STRATHBERRY LIMITED

4 WALKER STREET

EDINBURGH EH3 7LA

UNITED KINGDOM

[74] CHINA PATENT AGENT (HONG KONG) LIMITED

22/F, Great Eagle Centre, 23 Harbour Road, Wanchai

HONG KONG



- [11] 1914263.3
[15] 17-07-2019
[30] 17-01-2019 / EM / 006049524-0002
[51] Cl. 10-07
[54] 錶殼
Watch case
[73] LOUIS VUITTON MALLETIER
2 rue du Pont-Neuf
75001 Paris
FRANCE
[74] BAKER & MCKENZIE
14TH FLOOR, ONE TAIKOO PLACE,
979 KING'S ROAD, QUARRY BAY,
HONG KONG



-
- [11] 1914265.8M001
[15] 17-07-2019
[51] Cl. 7-02
[54] 炒菜機
Stir-fry machine
[73] 深圳市鉅兆商用智能爐業有限公司 中
國內地 廣東省深圳市龍崗區橫崗街道
西坑社區 百達街黃升發工業區廠房 1
號 102

香港鉅兆餐飲智能科技有限公司 香
港
九龍旺角彌敦道 788-790 號 利美
大廈 10 字樓 B 室
[74] 中港專利有限公司
港灣道 1 號會展廣場辦公大樓 30 樓 3012 室

HONG KONG

HONG KONG

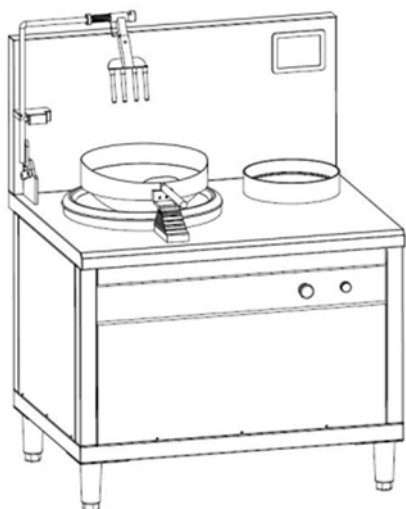

[11] 1914265.8M002

[15] 17-07-2019

[51] Cl. 7-02

[54] 炒菜機

Stir-fry machine

[73] 深圳市鉅兆商用智能爐業有限公司 中
國內地 廣東省深圳市龍崗區橫崗街道
西坑社區 百達街黃升發工業區廠房 1
號 102

香港鉅兆餐飲智能科技有限公司 香
港

九龍旺角彌敦道 788-790 號 利美
大廈 10 字樓 B 室

[74] 中港專利有限公司

港灣道 1 號會展廣場辦公大樓 30 樓 3012 室

HONG KONG

HONG KONG

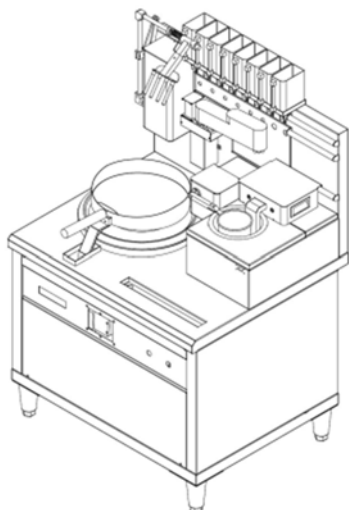

[11] 1914291.2

[15] 22-07-2019

[51] Cl. 7-04

[54] 朝鮮薊工具

Artichoke tool

[73] LEE YUEN HOUSEWARES CO., LTD.

Unit G, 12/F., World Tech Centre,
95 How Ming Street, Kwun Tong, Kowloon,
HONG KONG

[74] CHAN, TANG & KWOK

Rooms 2503-04, 25/F., Shanghai Industrial Investment Building,
48-62 Hennessy Road, Wanchai,
HONG KONG



[11] 1914304.1

[15] 23-07-2019

[51] Cl. 9-01

[54] 包裝瓶

Bottle for packing

[73] HITE JINRO Co., Ltd.

714, Yeongdong-daero,
Gangnam-gu, Seoul,
KOREA, REPUBLIC OF

[74] AWA ASIA LIMITED

Suite 1411, 14/F Leighton Centre
77 Leighton Road, Causeway Bay
HONG KONG



[11] 1914315.5M001

[15] 24-07-2019

[30] 11-03-2019 / CH / 144546

[51] Cl. 10-02

[54] 手錶

Wristwatch

[73] Luxury Goods International (L.G.I.) SA

Ch. Des Rochettes 2,
2016 Cortaillod,
SWITZERLAND

[74] ATL LAW OFFICES

16/F., China Hong Kong Tower,
8-12 Hennessy Road, Wanchai,
HONG KONG



[11] 1914315.5M002

[15] 24-07-2019

[30] 11-03-2019 / CH / 144546

[51] Cl. 10-07

[54] 錶扣

Watch buckle

[73] Luxury Goods International (L.G.I.) SA

Ch. Des Rochettes 2,

2016 Cortaillod,

SWITZERLAND

[74] ATL LAW OFFICES

16/F., China Hong Kong Tower,

8-12 Hennessy Road, Wanchai,

HONG KONG



[11] 1914316.7

[15] 25-07-2019

[30] 14-05-2019 / US / 29/691,066

[51] Cl. 9-01

[54] 雪人形狀瓶子

Bottle with snowman shape

[73] DART INDUSTRIES INC.
14901 S. Orange Blossom Trail
Orlando, Florida 32837
UNITED STATES

[74] WILKINSON & GRIST
6th Floor, Prince's Building
Chater Road
HONG KONG

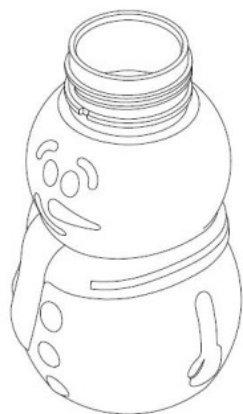

[11] 1914327.0

[15] 26-07-2019

[30] 15-03-2019 / CH / 144552

[51] Cl. 10-07

[54] 錶殼

Watch case

[73] Montres Tudor SA
3, rue François-Dussaud
1211 Genève 26
SWITZERLAND

[74] DEACONS
5th Floor, Alexandra House
Central
HONG KONG

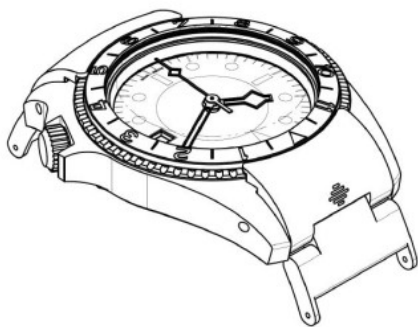

[11] 1914331.8M001

[15] 29-07-2019

[30] 22-02-2019 / WO / DM/200 997

[51] Cl. 10-02

[54] 錶

Watch

[73] MONTRES BREGUET SA (MONTRES BREGUET AG) (MONTRES BREGUET LTD)
CH-1344 L'ABBAYE,
SWITZERLAND

[74] SPRUSON & FERGUSON (HONG KONG) LIMITED
5001 Hopewell Centre
183 Queen's Road East, Wan Chai
HONG KONG



[11] 1914331.8M002

[15] 29-07-2019

[30] 22-02-2019 / WO / DM/200 997

[51] Cl. 10-02

[54] 錶

Watch

[73] MONTRES BREGUET SA (MONTRES BREGUET AG) (MONTRES BREGUET LTD)
CH-1344 L'ABBAYE,
SWITZERLAND

[74] SPRUSON & FERGUSON (HONG KONG) LIMITED
5001 Hopewell Centre
183 Queen's Road East, Wan Chai
HONG KONG



[11] 1914335.7M001

[15] 30-07-2019

[30] 31-01-2019 / GB, EU / WIPO79914

[51] Cl. 16-06

[54] 眼鏡
Glasses

[73] MONTBLANC-SIMPLO GMBH
HELLGRUNDWEG 100
D-22525 HAMBURG
GERMANY

[74] CHINA PATENT AGENT (HONG KONG) LIMITED
22/F, Great Eagle Centre, 23 Harbour Road, Wanchai
HONG KONG



[11] 1914335.7M002

[15] 30-07-2019

[30] 31-01-2019 / GB, EU / WIPO79914

[51] Cl. 16-06

[54] 眼鏡

Glasses

[73] MONTBLANC-SIMPLO GMBH

HELLGRUNDWEG 100

D-22525 HAMBURG

GERMANY

[74] CHINA PATENT AGENT (HONG KONG) LIMITED

22/F, Great Eagle Centre, 23 Harbour Road, Wanchai

HONG KONG



[11] 1914336.9

[15] 30-07-2019

[51] Cl. 25-02

[54] 浴室趟門

Bathroom Door

[73] 黎健忠

Lai Kin Chung

香港

新界葵涌大連排道 35-41 號 金基

工業大廈 24 樓 B2 室

[74] 天標知識產權代理有限公司

香港

九龍尖沙咀加連威老道 14 號 加連

威大廈 4 樓 A 座

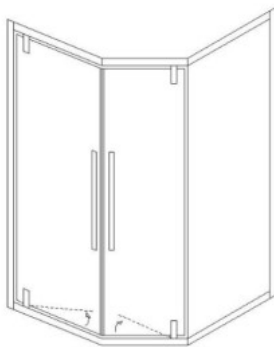

[11] 1914349.6M001

[15] 01-08-2019

[51] Cl. 3-01

[54] 行李箱

Luggage

[73] 新秀麗 IP 控股有限責任公司

Samsonite IP Holdings S.à r.l.

13-15 avenue de la Liberté

L-1931 Luxembourg

LUXEMBOURG

[74] WILKINSON & GRIST

6th Floor, Prince's Building

Chater Road

HONG KONG

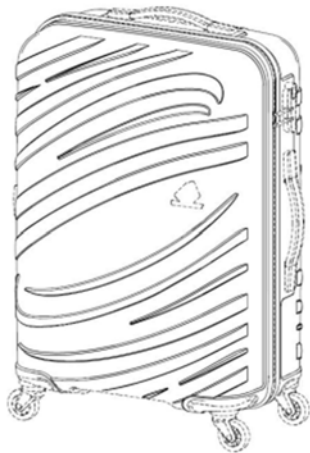

[11] 1914349.6M002

[15] 01-08-2019

[51] Cl. 3-01

[54] 行李箱

Luggage

[73] 新秀麗 IP 控股有限責任公司

Samsonite IP Holdings S.à r.l.

13-15 avenue de la Liberté

L-1931 Luxembourg

LUXEMBOURG

[74] WILKINSON & GRIST

6th Floor, Prince's Building

Chater Road

HONG KONG

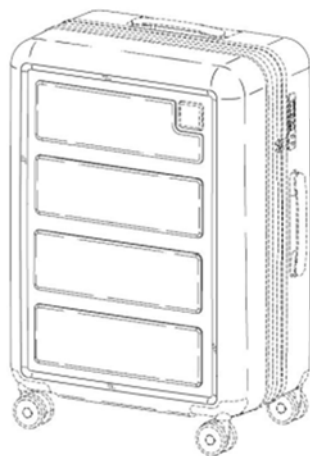

[11] 1914349.6M003

[15] 01-08-2019

[51] Cl. 3-01

[54] 行李箱

Luggage

[73] 新秀麗 IP 控股有限責任公司

Samsonite IP Holdings S.à r.l.

13-15 avenue de la Liberté

L-1931 Luxembourg

LUXEMBOURG

[74] WILKINSON & GRIST

6th Floor, Prince's Building

Chater Road

HONG KONG

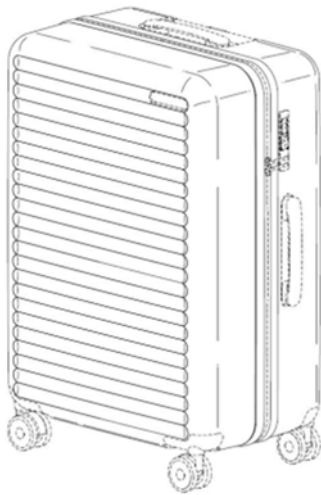

[11] 1914349.6M004

[15] 01-08-2019

[51] Cl. 3-01

[54] 行李箱

Luggage

[73] 新秀麗 IP 控股有限責任公司

Samsonite IP Holdings S.à r.l.

13-15 avenue de la Liberté

L-1931 Luxembourg

LUXEMBOURG

[74] WILKINSON & GRIST

6th Floor, Prince's Building

Chater Road

HONG KONG

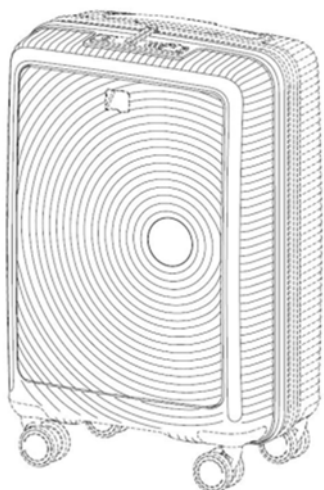

[11] 1914349.6M005

[15] 01-08-2019

[51] Cl. 3-01

[54] 行李箱

Luggage

[73] 新秀麗 IP 控股有限責任公司

Samsonite IP Holdings S.à r.l.

13-15 avenue de la Liberté

L-1931 Luxembourg

LUXEMBOURG

[74] WILKINSON & GRIST

6th Floor, Prince's Building

Chater Road

HONG KONG

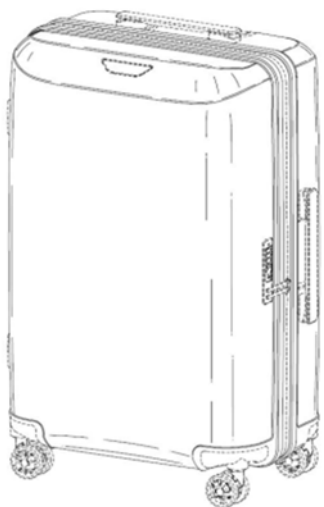

[11] 1914349.6M006

[15] 01-08-2019

[51] Cl. 3-01

[54] 行李箱

Luggage

[73] 新秀麗 IP 控股有限責任公司

Samsonite IP Holdings S.à r.l.

13-15 avenue de la Liberté

L-1931 Luxembourg

LUXEMBOURG

[74] WILKINSON & GRIST

6th Floor, Prince's Building

Chater Road

HONG KONG

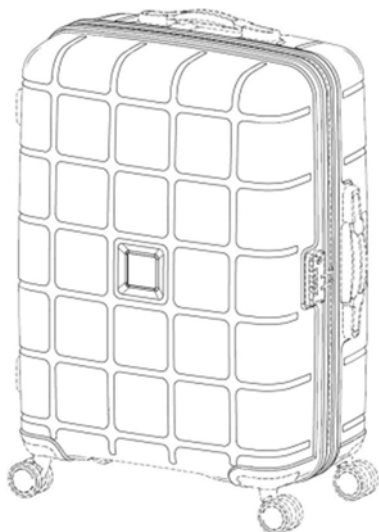

[11] 1914350.8M001

[15] 01-08-2019

[30] 19-07-2019 / EM / 006637195-0001

[51] Cl. 26-06

[54] 頭燈

Front light

[73] Bugatti International S.A.

412F route d'Esch

1030 Luxembourg

LUXEMBOURG

[74] WENPING & CO

1701 Tung Wai Commercial Building,

111 Gloucester Road,

HONG KONG



[11] 1914350.8M002

[15] 01-08-2019

[30] 19-07-2019 / EM / 006637195-0002

[51] Cl. 26-06

[54] 頭燈

Front light

[73] Bugatti International S.A.

412F route d'Esch

1030 Luxembourg

LUXEMBOURG

[74] WENPING & CO

1701 Tung Wai Commercial Building,

111 Gloucester Road,

HONG KONG



[11] 1914350.8M003

[15] 01-08-2019

[30] 19-07-2019 / EM / 006637195-0003

[51] Cl. 26-06

[54] 頭燈

Front light

[73] Bugatti International S.A.
412F route d'Esch
1030 Luxembourg
LUXEMBOURG

[74] WENPING & CO
1701 Tung Wai Commercial Building,
111 Gloucester Road,
HONG KONG



[11] 1914350.8M004

[15] 01-08-2019

[30] 19-07-2019 / EM / 006637195-0004

[51] Cl. 26-06

[54] 頭燈

Front light

[73] Bugatti International S.A.
412F route d'Esch
1030 Luxembourg
LUXEMBOURG

[74] WENPING & CO
1701 Tung Wai Commercial Building,
111 Gloucester Road,
HONG KONG



[11] 1914350.8M005

- [15] 01-08-2019
[30] 19-07-2019 / EM / 006635728-0003
[51] Cl. 26-06
[54] 尾燈
Rear light
[73] Bugatti International S.A.
412F route d'Esch
1030 Luxembourg
LUXEMBOURG
[74] WENPING & CO
1701 Tung Wai Commercial Building,
111 Gloucester Road,
HONG KONG



-
- [11] 1914350.8M006
[15] 01-08-2019
[30] 19-07-2019 / EM / 006635728-0004
[51] Cl. 26-06
[54] 尾燈
Rear light
[73] Bugatti International S.A.
412F route d'Esch
1030 Luxembourg
LUXEMBOURG
[74] WENPING & CO
1701 Tung Wai Commercial Building,
111 Gloucester Road,
HONG KONG



[11] 1914352.2M001

[15] 01-08-2019

[30] 19-07-2019 / EM / 006637088-0001

[51] Cl. 12-16

[54] 排氣管

Tailpipes

[73] Bugatti International S.A.

412F route d'Esch

1030 Luxembourg

LUXEMBOURG

[74] WENPING & CO

1701 Tung Wai Commercial Building,

111 Gloucester Road,

HONG KONG



[11] 1914352.2M002

[15] 01-08-2019

[30] 19-07-2019 / EM / 006637088-0002

[51] Cl. 12-16

[54] 車身面板

Vehicle body panel

[73] Bugatti International S.A.

412F route d'Esch

1030 Luxembourg

LUXEMBOURG

[74] WENPING & CO

1701 Tung Wai Commercial Building,

111 Gloucester Road,

HONG KONG



[11] 1914352.2M003

[15] 01-08-2019

[30] 19-07-2019 / EM / 006637088-0003

[51] Cl. 12-16

[54] 輪緣

Wheel rim

[73] Bugatti International S.A.

412F route d'Esch

1030 Luxembourg

LUXEMBOURG

[74] WENPING & CO

1701 Tung Wai Commercial Building,

111 Gloucester Road,

HONG KONG



[11] 1914353.4M001

[15] 01-08-2019

[30] 04-03-2019 / EM / 006275244-0001

[51] Cl. 26-06

[54] 頭燈

Front light

[73] Bugatti International S.A.

412F route d'Esch

1030 Luxembourg

LUXEMBOURG

[74] WENPING & CO

1701 Tung Wai Commercial Building,

111 Gloucester Road,
HONG KONG



[11] 1914353.4M002

[15] 01-08-2019

[30] 04-03-2019 / EM / 006275244-0002

[51] Cl. 26-06

[54] 頭燈

Front light

[73] Bugatti International S.A.

412F route d'Esch

1030 Luxembourg

LUXEMBOURG

[74] WENPING & CO

1701 Tung Wai Commercial Building,

111 Gloucester Road,

HONG KONG

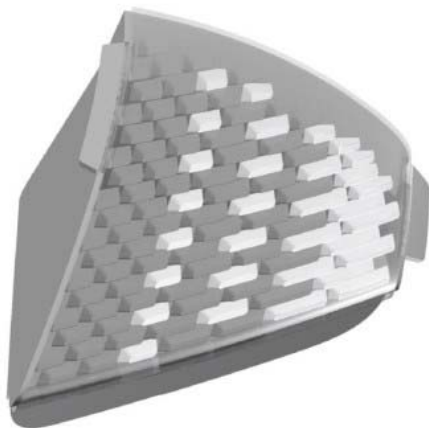

[11] 1914353.4M003

[15] 01-08-2019

[30] 04-03-2019 / EM / 006275244-0003

[51] Cl. 26-06

[54] 尾燈

Rear light

[73] Bugatti International S.A.

412F route d'Esch

1030 Luxembourg

LUXEMBOURG

[74] WENPING & CO

1701 Tung Wai Commercial Building,

111 Gloucester Road,

HONG KONG

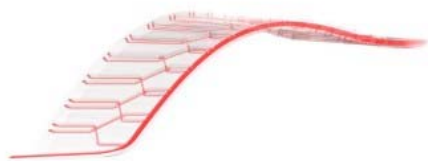

[11] 1914354.6M001

[15] 01-08-2019

[30] 04-03-2019 / EM / 006276655-0001

[51] Cl. 12-08

[54] 汽車

Automobile

[73] Bugatti International S.A.

412F route d'Esch

1030 Luxembourg

LUXEMBOURG

[74] WENPING & CO

1701 Tung Wai Commercial Building,

111 Gloucester Road,

HONG KONG

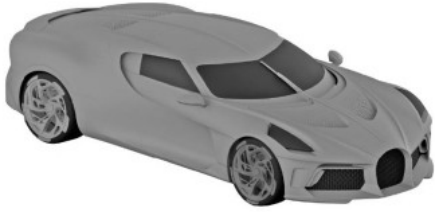

[11] 1914354.6M002

[15] 01-08-2019

[30] 04-03-2019 / EM / 006276655-0006

[51] Cl. 12-16

[54] 輪緣

Wheel rim

[73] Bugatti International S.A.

412F route d'Esch

1030 Luxembourg

LUXEMBOURG

[74] WENPING & CO

1701 Tung Wai Commercial Building,

111 Gloucester Road,

HONG KONG



[11] 1914354.6M003

[15] 01-08-2019

[30] 04-03-2019 / EM / 006276655-0007

[51] Cl. 12-16

[54] 引擎蓋

Bonnet

[73] Bugatti International S.A.

412F route d'Esch

1030 Luxembourg

LUXEMBOURG

[74] WENPING & CO

1701 Tung Wai Commercial Building,

111 Gloucester Road,

HONG KONG

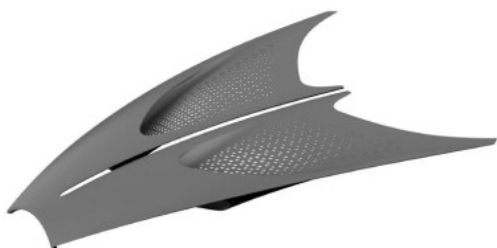

[11] 1914354.6M004

[15] 01-08-2019

[30] 04-03-2019 / EM / 006276655-0008

[51] Cl. 12-16

[54] 擋風玻璃

Windshield

[73] Bugatti International S.A.

412F route d'Esch

1030 Luxembourg

LUXEMBOURG

[74] WENPING & CO

1701 Tung Wai Commercial Building,

111 Gloucester Road,

HONG KONG



[11] 1914355.9M001

[15] 01-08-2019

[30] 04-02-2019 / US / 29/679,293

[51] Cl. 14-04

[54] 帶有圖形用戶界面的電子裝置顯示屏或其一部分

Display screen or portion thereof of an electronic device with graphical user interface

[73] 蘋果公司

APPLE INC.

ONE APPLE PARK WAY, CUPERTINO, CALIFORNIA 95014

UNITED STATES

[74] CLT PATENT & TRADEMARK (H.K.) LIMITED

Unit 09, 34/F., Office Tower, Convention Plaza

No. 1 Harbour Road, Wanchai

HONG KONG

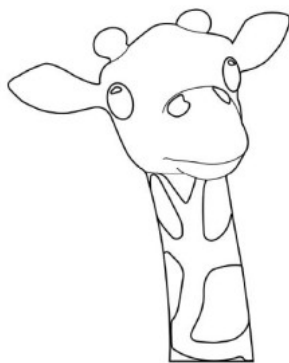

[11] 1914355.9M002

[15] 01-08-2019

[30] 04-02-2019 / US / 29/679,293

[51] Cl. 14-04

[54] 帶有圖形用戶界面的電子裝置顯示屏或其一部分

Display screen or portion thereof of an electronic device with graphical user interface

[73] 蘋果公司

APPLE INC.

ONE APPLE PARK WAY, CUPERTINO, CALIFORNIA 95014

UNITED STATES

[74] CLT PATENT & TRADEMARK (H.K.) LIMITED

Unit 09, 34/F., Office Tower, Convention Plaza

No. 1 Harbour Road, Wanchai

HONG KONG

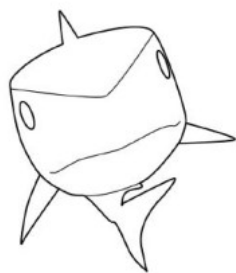

[11] 1914359.7

[15] 01-08-2019

[51] Cl. 23-04

[54] 取暖換氣扇面罩

Louver for a heating and ventilating fan

[73] 廣東松下環境系統有限公司

Panasonic Ecology Systems Guangdong Co., Ltd.

2 South Chaogui Road, Shunde High-Tech Industrial Zone

(Ronggui),

Foshan, Guangdong, P.R. China 528306

CHINA

[74] MARKS & CLERK

Level 9, Cyberport 1

100 Cyberport Road, Pok Fu Lam

HONG KONG

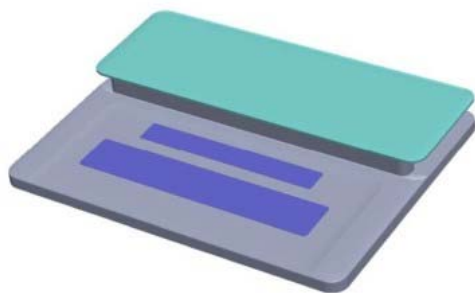

[11] 1914362.3M001

[15] 01-08-2019

[30] 26-02-2019 / EM / 006267340

[51] Cl. 23-04

[54] 空氣淨化器

Air purifier

[73] Koninklijke Philips N.V.

High Tech Campus 5,

5656 AE Eindhoven
NETHERLANDS

[74] WILKINSON & GRIST
6th Floor, Prince's Building
Chater Road
HONG KONG

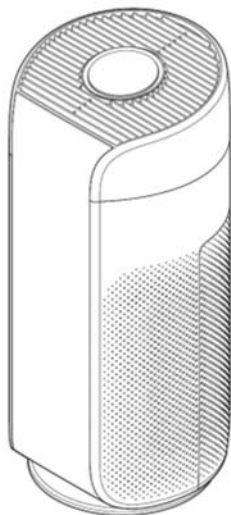

[11] 1914362.3M002

[15] 01-08-2019

[30] 26-02-2019 / EM / 006267340

[51] Cl. 23-04

[54] 空氣淨化器

Air purifier

[73] Koninklijke Philips N.V.

High Tech Campus 5,

5656 AE Eindhoven

NETHERLANDS

[74] WILKINSON & GRIST

6th Floor, Prince's Building

Chater Road

HONG KONG

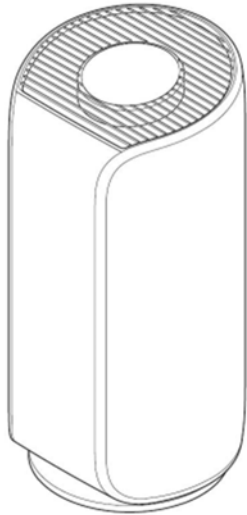

[11] 1914364.7

[15] 01-08-2019

[30] 15-05-2019 / JP / 2019 of 010548

[51] Cl. 26-06

[54] 汽車尾燈

Tail Lamp for Vehicles

[73] M-TEC Co., Ltd.

2-15-11 Hizaori-cho,
Asaka-shi, Saitama-ken,
JAPAN

[74] EMILY YIP & CO

1st Floor, Kingsfield Centre
18 Shell Street, Fortress Hill
HONG KONG



[11] 1914365.0

[15] 01-08-2019

[30] 15-05-2019 / JP / 2019 of 010549

[51] Cl. 12-16

[54] 汽車方向盤

Steering wheel for vehicles

[73] M-TEC Co., Ltd.

2-15-11 Hizaori-cho,
Asaka-shi, Saitama-ken,
JAPAN

[74] EMILY YIP & CO

1st Floor, Kingsfield Centre
18 Shell Street, Fortress Hill
HONG KONG



[11] 1914366.2M001

[15] 02-08-2019

[51] Cl. 9-03

[54] 包裝盒

Packaging box

[73] 卡萊美化妝品有限公司

Colourmix Cosmetics Company Limited
10th Floor, Wyler Centre, Phase 2
192-200 Tai Lin Pai Road
Kwai Chung, New Territories
HONG KONG

[74] MARKPAL IP LIMITED

Unit A, 11/F Amtel Building
144-148 Des Voeux Road Central
HONG KONG



[11] 1914366.2M002

[15] 02-08-2019

[51] Cl. 9-01

[54] 化妝品用瓶

Flask for cosmetics

[73] 卡萊美化妝品有限公司

Colourmix Cosmetics Company Limited

10th Floor, Wyler Centre, Phase 2

192-200 Tai Lin Pai Road

Kwai Chung, New Territories

HONG KONG

[74] MARKPAL IP LIMITED

Unit A, 11/F Amtel Building

144-148 Des Voeux Road Central

HONG KONG



- [11] 1914947.5M001
[15] 05-11-2019
[30] 09-05-2019 / NO, CH, TR, GB, EU / WIPO83338
[51] Cl. 12-16
[54] 變速杆
Gear shift lever
[73] VOLKSWAGEN AKTIENGESELLSCHAFT
38436 WOLFSBURG
GERMANY
[74] CHINA PATENT AGENT (HONG KONG) LIMITED
22/F, Great Eagle Centre, 23 Harbour Road,
Wanchai
HONG KONG



-
- [11] 1914947.5M002
[15] 05-11-2019
[30] 09-05-2019 / EU, NO, CH, GB, TR / WIPO83338
[51] Cl. 12-16
[54] 變速杆
Gear shift lever
[73] VOLKSWAGEN AKTIENGESELLSCHAFT
38436 WOLFSBURG
GERMANY
[74] CHINA PATENT AGENT (HONG KONG) LIMITED
22/F, Great Eagle Centre, 23 Harbour Road,
Wanchai
HONG KONG



[11] 1915083.2M001

[15] 26-11-2019

[30] 18-09-2019 / LI / 2019-679

[51] Cl. 19-06

[54] 筆

Pen

[73] Swarovski Aktiengesellschaft

Dröschistrasse 15,

9495 Triesen,

LIECHTENSTEIN

[74] BAKER & MCKENZIE

14TH FLOOR, ONE TAIKOO PLACE,

979 KING'S ROAD, QUARRY BAY,

HONG KONG

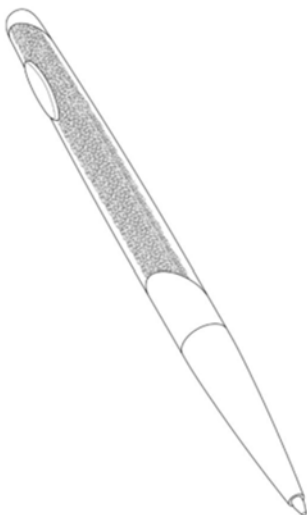

[11] 1915083.2M002

[15] 26-11-2019

[30] 18-09-2019 / LI / 2019-679

[51] Cl. 19-06

[54] 筆

Pen

[73] Swarovski Aktiengesellschaft

Dröschistrasse 15,

9495 Triesen,

LIECHTENSTEIN

[74] BAKER & MCKENZIE

14TH FLOOR, ONE TAIKOO PLACE,

979 KING'S ROAD, QUARRY BAY,

HONG KONG

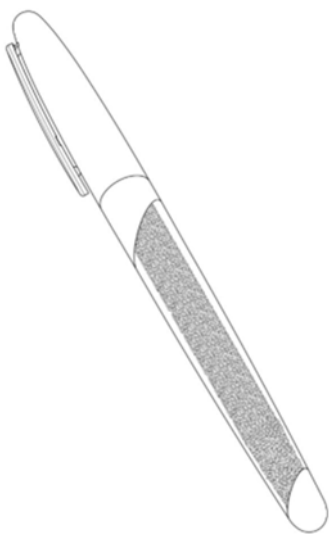

[11] 1915084.4M001

[15] 26-11-2019

[30] 19-09-2019 / LI / 2019-684

[51] Cl. 10-02

[54] 錶

Watch

[73] SWAROVSKI AKTIENGESELLSCHAFT

Dröschistrasse 15,

9495 Triesen,

LIECHTENSTEIN

[74] BAKER & MCKENZIE

14TH FLOOR, ONE TAIKOO PLACE,

979 KING'S ROAD, QUARRY BAY,

HONG KONG



[11] 1915084.4M002

[15] 26-11-2019

[30] 19-09-2019 / LI / 2019-684

[51] Cl. 10-02

[54] 錶

Watch

[73] SWAROVSKI AKTIENGESELLSCHAFT
Dröschistrasse 15,
9495 Triesen,
LIECHTENSTEIN

[74] BAKER & MCKENZIE
14TH FLOOR, ONE TAIKOO PLACE,
979 KING'S ROAD, QUARRY BAY,
HONG KONG



[11] 1915084.4M003

[15] 26-11-2019

[30] 19-09-2019 / LI / 2019-684

[51] Cl. 10-02

[54] 錶

Watch

[73] SWAROVSKI AKTIENGESELLSCHAFT

Dröschistrasse 15,

9495 Triesen,

LIECHTENSTEIN

[74] BAKER & MCKENZIE

14TH FLOOR, ONE TAIKOO PLACE,

979 KING'S ROAD, QUARRY BAY,

HONG KONG





香港特別行政區政府知識產權署外觀設計註冊處

The Government of the Hong Kong Special Administrative Region

Designs Registry, Intellectual Property Department

根據註冊外觀設計條例第 28 條，下列註冊外觀設計因未繳續期費而停止有效。各組記項按註冊外觀設計停止有效日期及註冊編號先後次序排列。

Registered designs ceased through non-payment of renewal fees under section 28 of the Registered Designs Ordinance. Entries are listed below under their expiry dates.

27-12-2019 - 30-12-2019

27-12-2019	0902232.2M002
0412966.6	0902232.2M003
0412967.8	0902232.2M004
0902209.4M001	0902232.2M005
0902209.4M002	0902232.2M006
0902210.6	0902232.2M009
0902211.8	0902233.4M001
0902213.2M001	0902233.4M002
0902213.2M002	0902233.4M003
9911761.4M002	0902233.4M004
9911763.8M002	0902233.4M005
	0902233.4M006

28-12-2019	1402447.5M001
0902214.4	1402447.5M002
0902215.7	1402447.5M003
1402426.1	1402449.9M001
1402427.3	1402449.9M002
1402428.5	1402449.9M003
1402430.9	1402451.3M002
9911765.3	1402452.5
9911768.9	1402453.7

29-12-2019	0902227.2M001
	0902227.2M002
	1402434.7M001
	1402434.7M002
	1402436.2
	1402437.4
	1402438.6
	1402439.8

30-12-2019	0902232.2M001
-------------------	---------------



香港特別行政區政府知識產權署外觀設計註冊處

The Government of the Hong Kong Special Administrative Region

Designs Registry, Intellectual Property Department

根據註冊外觀設計規則第 31 條刪除的註冊外觀設計。各組記項按註冊外觀設計 刪除日期及註冊編號先後次序排列。

Registered designs removed under section 31 of the Registered Designs Rules. Entries are listed below under their removal dates.

03-01-2020 - 06-01-2020

03-01-2020

1401205.2M001

1401205.2M002

1401207.6M001

1401207.6M002

1401208.8

1401211.4

1401212.6

1401213.8

1401214.0

1401215.3

1401217.7

1401218.9

1401219.1M001

1401219.1M002

1401219.1M003

1401220.3M001

1401220.3M002

06-01-2020

0901033.9

0901036.6M001

0901036.6M002

0901037.8

0901039.2

1401224.1

1401226.6

1401227.8

9910799.3

9910801.9

9910802.1



香港特別行政區政府知識產權署外觀設計註冊處
The Government of the Hong Kong Special Administrative Region
Designs Registry, Intellectual Property Department

勘誤
CORRIGENDUM

已在官方公報刊登的外觀設計公告內的註冊擁有人地址更正如下：

The following show the corrected registered owner's address in advertisement previously published in the official journal:

官方公報日期 Official journal date 06.12.2019

- [11] 1914011.0M001
[73] 90 5th Avenue, 8th Floor New York, NY 10011, UNITED STATES
- [11] 1914011.0M002
[73] 90 5th Avenue, 8th Floor New York, NY 10011, UNITED STATES