

# 香港知識產權公報

Hong Kong Intellectual Property Journal

2019 年 5 月 24 日

24 May 2019

## 目錄

### Contents

#### 根據註冊外觀設計條例第 25 條註冊的外觀設計

#### **Designs Registered under section 25 of the Registered Designs Ordinance**

按註冊編號排列

Arranged by Registration Number

#### 根據註冊外觀設計條例(第 522 章)公布的其他公告

#### **Other Notices Published under the Registered Designs Ordinance (Cap. 522)**

根據註冊外觀設計條例第 28 條, 註冊外觀設計因未繳續期費而停止有效

Registered designs ceased through non-payment of renewal fees under section 28 of the Registered Designs Ordinance

根據註冊外觀設計規則第 31 條刪除的註冊外觀設計

Registered designs removed under section 31 of the Registered Designs Rules

#### 以下事項沒有記錄

#### **No Records for the Following Matters**

根據註冊外觀設計條例第 30 條放棄的外觀設計的註冊

Surrender of Registration of Design under section 30 of the Registered Designs Ordinance

根據註冊外觀設計規則第 37 條, 向處長作出轉介

Reference to Registrar under section 37 of the Registered Designs Rules

根據註冊外觀設計條例第 45 條, 撤銷註冊

Revocation of Registration under section 45 of the Registered Designs Ordinance

根據註冊外觀設計規則第 46 條，向法院作出轉介  
Reference to Court under section 46 of the Registered Designs Rules

根據註冊外觀設計規則第 63 條對不符合規定之處作出糾正  
Rectification of Irregularities under section 63 of the Registered Designs Rules

根據註冊外觀設計條例第 66 條，糾正註冊紀錄冊  
Rectification of Register under section 66 of the Registered Designs Ordinance

根據註冊外觀設計條例第 67 條，更正註冊紀錄冊內的錯誤  
Correction of Errors in Register under section 67 of the Registered Designs Ordinance

根據註冊外觀設計條例第 67 及 76 條，更正註冊紀錄冊內及已提交文件中的錯誤  
Correction of Errors in Register and in Filed Documents under sections  
67 and 76 of the Registered Designs Ordinance

根據註冊外觀設計條例第 76 條，更正已提交文件中的錯誤  
Correction of Errors in Filed Documents under section 76 of the Registered Designs  
Ordinance

勘誤  
Corrigendum

## 註冊外觀設計公告註釋

### Notes on advertisements of registration of designs

方括號表示下列資料：

Square brackets indicate the following data：

[11] 註冊編號 Registration number / 聯合王國註冊編號 United Kingdom registration number

[15] 註冊日期 Registration date / 當作註冊日期 Deemed registration date / 聯合王國註冊日期 United Kingdom registration date

[17] 註冊有效期屆滿日期 Expiry date of the period of registration

[22] 提交日期 Filing date / 當作提交日期 Deemed filing date / 聯合王國提交日期 United Kingdom filing date

[30] 聲稱享有的優先權 (提交日期 / 巴黎公約國或世界貿易組織成員 / 申請編號) Priority claimed (filing date / Paris Convention country or WTO member / application number)

[51] 國際外觀設計分類號 (洛迦諾分類號) International Classification of designs (Locarno Classification)

[54] 物品 Article

[55] 外觀設計的表述 Representation of the design

[62] 分開前的申請編號及提交日期 Application number before division and filing date

[66] 過往註冊的聯繫外觀設計註冊編號 / 日期 Registration No. / Date of Previous Registration for Association

[72] 設計人 Designer

[73] 擁有人姓名和地址 Name and address of the owner

[74] 代理人 Agent / 送達地址 Address for service



香港特別行政區政府知識產權署外觀設計註冊處

The Government of the Hong Kong Special Administrative Region

Designs Registry, Intellectual Property Department

## 根據註冊外觀設計條例第 25 條註冊的外觀設計

### Designs registered under section 25 of the Registered Designs Ordinance

按註冊編號排列

Arranged by Registration Number

[11] 1801779.2

[15] 31-08-2018

[51] Cl. 19-02

[54] 伸縮式扣件

Retractable buckle

[73] TSAI HAI PIN

香港九龍官塘 鴻圖

道 57 號

南洋廣場 1805 室

[74] TOMBO INDUSTRIES CO., LTD.

香港九龍 官塘鴻圖

道 57 號

南洋廣場 18 樓 1805 室

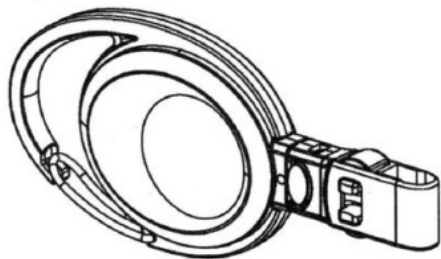

---

[11] 1801795.6

[15] 03-09-2018

[30] 05-03-2018 / CN / 201830081945.X

[51] Cl. 15-99

[54] 機器人

Robot

[73] Rokid Corporation Ltd

the offices of Offshore Incorporations (Cayman) Limited,

P.O. Box 31119 Grand Pavilion, Hibiscus Way, 802 West Bay Road,  
Grand Cayman, KY1-1205, CAYMAN ISLANDS

- [74] HONG KONG INTELLECTUAL PROPERTY AGENT LIMITED  
Unit 230, 2/F, Building 12W,  
No.12 Science Park West Avenue,  
Phase 3, Hong Kong Science Park, Pak Shek Kok, N.T., Hong Kong.



---

[11] 1801796.8

[15] 03-09-2018

[30] 05-03-2018 / CN / 201830082089.X

[51] Cl. 15-99

[54] 機器人  
Robot

- [73] Rokid Corporation Ltd  
the offices of Offshore Incorporations (Cayman) Limited,  
P.O. Box 31119 Grand Pavilion, Hibiscus Way, 802 West Bay Road,  
Grand Cayman, KY1-1205, CAYMAN ISLANDS

- [74] HONG KONG INTELLECTUAL PROPERTY AGENT LIMITED  
Unit 230, 2/F, Building 12W,  
No.12 Science Park West Avenue,  
Phase 3, Hong Kong Science Park, Pak Shek Kok, N.T., Hong Kong.



[11] 1801808.5

[15] 04-09-2018

[51] Cl. 7-03

[54] 可拆卸抓臂的多功能餐具

Multi-functional cutlery with detachable grabbing arms

[73] Lau Chow Ming

Room/Flat 1825, Sun Fong House,  
Sun Chui Estate, Shatin,  
N.T., Hong Kong.

Yip Kim Hung

Flact C, 13/F, Block 1, Metropolis Plaza,  
8 Lung Wan Road, Sheung Shui,  
N.T., Hong Kong

[74] Stephenson Harwood

18th floor, United Centre,  
95 Queensway,  
Hong Kong.



---

[11] 1801984.6M001

[15] 28-09-2018

[51] Cl. 2-03

[54] 耳掛

Ear hook

[73] Ansheles Artem

Flat B, 1/F, 17A Java rd.,  
North Point,  
Hong Kong

[74] Accolade IP Limited

Room 702, 7/F.,  
Fu Fai Commercial Centre,  
27 Hillier Street, Hong Kong.





---

[11] 1801984.6M002

[15] 28-09-2018

[51] Cl. 2-03

[54] 耳掛

Ear hook

[73] Ansheles Artem

Flat B, 1/F, 17A Java rd.,

North Point,

Hong Kong

[74] Accolade IP Limited

Room 702, 7/F.,

Fu Fai Commercial Centre,

27 Hillier Street, Hong Kong.



---

[11] 1801985.9

[15] 28-09-2018

[30] 13-04-2018 / EM / 005233475-0001

[51] Cl. 9-01

[54] 瓶子

Bottle

[73] Société des Produits Nestlé S.A.  
1800 Vevey,  
SWITZERLAND

[74] Deacons  
5th Floor,  
Alexandra House,  
Central, Hong Kong.



---

[11] 1802012.7M001

[15] 08-10-2018

[51] Cl. 10-02

[54] 手錶

Wristwatch

[73] SWATCH AG (SWATCH SA) (SWATCH LTD.)  
Jakob-Stämpfli-Strasse 94,  
2502 Biel/Bienne,  
SWITZERLAND

[74] Spruson & Ferguson (Hong Kong) Limited  
5001 Hopewell Centre,  
183 Queen's Road East,  
Hong Kong.



---

[11] 1802012.7M002

[15] 08-10-2018

[51] Cl. 10-02

[54] 手錶

Wristwatch

[73] SWATCH AG (SWATCH SA) (SWATCH LTD.)  
Jakob-Stämpfli-Strasse 94,  
2502 Biel/Bienne,  
SWITZERLAND

[74] Spruson & Ferguson (Hong Kong) Limited  
5001 Hopewell Centre,  
183 Queen's Road East,  
Hong Kong.



---

[11] 1802012.7M003

[15] 08-10-2018

[51] Cl. 10-02

[54] 手錶

Wristwatch

[73] SWATCH AG (SWATCH SA) (SWATCH LTD.)  
Jakob-Stämpfli-Strasse 94,  
2502 Biel/Bienne,  
SWITZERLAND

[74] Spruson & Ferguson (Hong Kong) Limited  
5001 Hopewell Centre,  
183 Queen's Road East,  
Hong Kong.



[11] 1802013.9M001

[15] 09-10-2018

[51] Cl. 10-02

[54] 手錶

Wristwatch

[73] SWATCH AG (SWATCH SA) (SWATCH LTD.)

Jakob-Stämpfli-Strasse 94,

CH-2502 Biel/Bienne,

SWITZERLAND

[74] Spruson & Ferguson (Hong Kong) Limited

5001 Hopewell Centre,

183 Queen's Road East,

Hong Kong.



---

[11] 1802013.9M002

[15] 09-10-2018

[51] Cl. 10-02

[54] 手錶

Wristwatch

[73] SWATCH AG (SWATCH SA) (SWATCH LTD.)

Jakob-Stämpfli-Strasse 94, CH-2502 Biel/Bienne, SWITZERLAND

[74] Spruson & Ferguson (Hong Kong) Limited

5001 Hopewell Centre, 183 Queen's Road East, Hong Kong.



[11] 1802013.9M003

[15] 09-10-2018

[51] Cl. 10-02

[54] 手錶

Wristwatch

[73] SWATCH AG (SWATCH SA) (SWATCH LTD.)

Jakob-Stämpfli-Strasse 94, CH-2502 Biel/Bienne, SWITZERLAND

[74] Spruson & Ferguson (Hong Kong) Limited

5001 Hopewell Centre, 183 Queen's Road East, Hong Kong.



---

[11] 1802013.9M004

[15] 09-10-2018

[51] Cl. 10-02

[54] 手錶

Wristwatch

[73] SWATCH AG (SWATCH SA) (SWATCH LTD.)

Jakob-Stämpfli-Strasse 94, CH-2502 Biel/Bienne, SWITZERLAND

[74] Spruson & Ferguson (Hong Kong) Limited

5001 Hopewell Centre, 183 Queen's Road East, Hong Kong.



[11] 1802013.9M005

[15] 09-10-2018

[51] Cl. 10-02

[54] 手錶

Wristwatch

[73] SWATCH AG (SWATCH SA) (SWATCH LTD.)

Jakob-Stämpfli-Strasse 94, CH-2502 Biel/Bienne, SWITZERLAND

[74] Spruson & Ferguson (Hong Kong) Limited

5001 Hopewell Centre, 183 Queen's Road East, Hong Kong.



---

[11] 1802013.9M006

[15] 09-10-2018

[51] Cl. 10-02

[54] 手錶

Wristwatch

[73] SWATCH AG (SWATCH SA) (SWATCH LTD.)

Jakob-Stämpfli-Strasse 94, CH-2502 Biel/Bienne, SWITZERLAND

[74] Spruson & Ferguson (Hong Kong) Limited

5001 Hopewell Centre, 183 Queen's Road East, Hong Kong.



---

[11] 1802013.9M007

[15] 09-10-2018

[51] Cl. 10-02

[54] 手錶

Wristwatch

[73] SWATCH AG (SWATCH SA) (SWATCH LTD.)

Jakob-Stämpfli-Strasse 94, CH-2502 Biel/Bienne, SWITZERLAND

[74] Spruson & Ferguson (Hong Kong) Limited

5001 Hopewell Centre, 183 Queen's Road East, Hong Kong.



---

[11] 1802013.9M008

[15] 09-10-2018

[51] Cl. 10-02

[54] 手錶

Wristwatch

[73] SWATCH AG (SWATCH SA) (SWATCH LTD.)

Jakob-Stämpfli-Strasse 94, CH-2502 Biel/Bienne, SWITZERLAND

[74] Spruson & Ferguson (Hong Kong) Limited

5001 Hopewell Centre, 183 Queen's Road East, Hong Kong.



---

[11] 1802013.9M009

[15] 09-10-2018

[51] Cl. 10-02

[54] 手錶

Wristwatch

[73] SWATCH AG (SWATCH SA) (SWATCH LTD.)

Jakob-Stämpfli-Strasse 94, CH-2502 Biel/Bienne, SWITZERLAND

[74] Spruson & Ferguson (Hong Kong) Limited

5001 Hopewell Centre, 183 Queen's Road East, Hong Kong.



---

[11] 1802013.9M010

[15] 09-10-2018

[51] Cl. 10-02

[54] 手錶

Wristwatch

[73] SWATCH AG (SWATCH SA) (SWATCH LTD.)

Jakob-Stämpfli-Strasse 94, CH-2502 Biel/Bienne, SWITZERLAND

[74] Spruson & Ferguson (Hong Kong) Limited

5001 Hopewell Centre, 183 Queen's Road East, Hong Kong.



---

[11] 1802033.1M001

[15] 10-10-2018

[51] Cl. 3-01

[54] 急救包

First response casualty pouch

[73] East Gear (International) Corp Limited

香港九龍長沙灣 青

山道 688-690 號

嘉名工廠大廈 2 樓 E 室

[74] East Gear (International) Corp Limited

香港九龍長沙灣



青山道 688-690 號 嘉名  
工廠大廈 2 樓 E 室



---

[11] 1802033.1M002

[15] 10-10-2018

[51] Cl. 3-01

[54] 止血帶袋

Tourniquet pouch

[73] East Gear (International) Corp Limited  
香港九龍長沙灣 青山道 688-690 號 嘉名工廠大廈 2 樓 E 室

[74] East Gear (International) Corp Limited  
香港九龍長沙灣 青山道 688-690 號 嘉名工廠大廈 2 樓 E 室

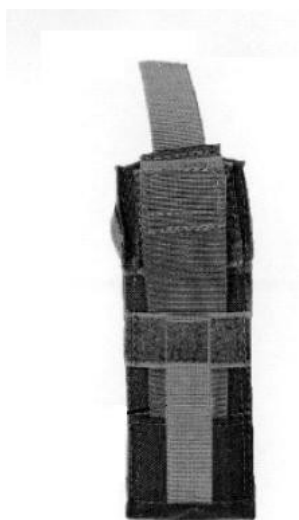

---

[11] 1802050.7

[15] 28-02-2019

[51] Cl. 6-01

[54] 戶外扶手椅

Outdoor armchair

[73] Maiori Design Co. Ltd.

1001, Westley Square,  
48, Hoi Yuen Rd., Kwun Tong,  
Kowloon, Hong Kong

[74] Maiori Design Co. Ltd.

1001, Westley Square,  
48, Hoi Yuen Rd., Kwun Tong,  
Kowloon, Hong Kong



---

[11] 1802051.9

[15] 28-02-2019

[51] Cl. 26-05

[54] 太陽能燈

Solar powered lamp

[73] Maiori Design Co. Ltd.

1001, Westley Square,  
48, Hoi Yuen Rd., Kwun Tong,  
Kowloon, Hong Kong

[74] Maiori Design Co. Ltd.

1001, Westley Square,  
48, Hoi Yuen Rd., Kwun Tong,  
Kowloon, Hong Kong



---

[11] 1802052.1

[15] 28-02-2019

[51] Cl. 26-05

[54] 太陽能燈

Solar powered lamp

[73] Maiori Design Co. Ltd.

1001, Westley Square,

48, Hoi Yuen Rd., Kwun Tong,

Kowloon, Hong Kong

[74] Maiori Design Co. Ltd.

1001, Westley Square,

48, Hoi Yuen Rd., Kwun Tong,

Kowloon, Hong Kong

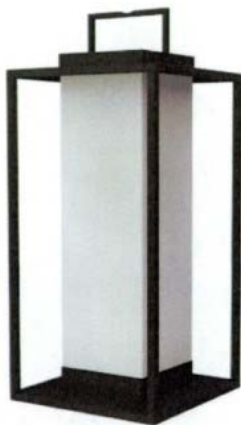

---

[11] 1802053.3

[15] 28-02-2019

[51] Cl. 6-01

[54] 戶外編藤扶手椅

Outdoor rattan armchair

[73] Maiori Design Co. Ltd.

1001, Westley Square,  
48, Hoi Yuen Rd., Kwun Tong,  
Kowloon, Hong Kong

[74] Maiori Design Co. Ltd.

1001, Westley Square,  
48, Hoi Yuen Rd., Kwun Tong,  
Kowloon, Hong Kong



---

[11] 1802054.5

[15] 28-02-2019

[51] Cl. 6-01

[54] 戶外編織躺椅

Outdoor chaise lounge

[73] Maiori Design Co. Ltd.

1001, Westley Square,  
48, Hoi Yuen Rd., Kwun Tong,  
Kowloon, Hong Kong

[74] Maiori Design Co. Ltd.

1001, Westley Square,  
48, Hoi Yuen Rd., Kwun Tong,  
Kowloon, Hong Kong



---

[11] 1802055.8

[15] 28-02-2019

[51] Cl. 6-01

[54] 戶外酒吧凳

Outdoor bar stool

[73] Maiori Design Co. Ltd.

1001, Westley Square,  
48, Hoi Yuen Rd., Kwun Tong,  
Kowloon, Hong Kong

[74] Maiori Design Co. Ltd.

1001, Westley Square,  
48, Hoi Yuen Rd., Kwun Tong,  
Kowloon, Hong Kong



---

[11] 1802060.8M001

[15] 15-10-2018

[30] 16-04-2018 / CA / 180,884

[51] Cl. 21-03

[54] 水滑道

Water slide

[73] ProSlide Technology Inc.

2650 QUEENSVIEW DRIVE, SUITE 150 OTTAWA,

ONTARIO K2B 8H6 CANADA,

CANADA

[74] China Patent Agent (H.K.) Ltd.

22/F, Great Eagle Centre,

23 Harbour Road, Wanchai,

Hong Kong.



---

[11] 1802060.8M002

[15] 15-10-2018

[30] 16-04-2018 / CA / 180,884

[51] Cl. 21-03

[54] 水滑道

Water slide

[73] ProSlide Technology Inc.

2650 QUEENSVIEW DRIVE, SUITE 150 OTTAWA,

ONTARIO K2B 8H6 CANADA,

CANADA

[74] China Patent Agent (H.K.) Ltd.

22/F, Great Eagle Centre,

23 Harbour Road, Wanchai,

Hong Kong.



---

[11] 1802060.8M003

[15] 15-10-2018

[30] 16-04-2018 / CA / 180,884

[51] Cl. 21-03

[54] 水滑道

Water slide

[73] ProSlide Technology Inc.

2650 QUEENSVIEW DRIVE, SUITE 150 OTTAWA, ONTARIO K2B 8H6  
CANADA, CANADA

[74] China Patent Agent (H.K.) Ltd.

22/F, Great Eagle Centre, 23 Harbour Road, Wanchai, Hong Kong.



---

[11] 1802078.6M001

[15] 18-10-2018

[30] 08-05-2018 / CN / 201830203119.8

[51] Cl. 14-04

[54] 用於遙控面板的圖形用戶界面

The remote control panel with a graphical user interface

[73] 廣東松下環境系統有限公司

Panasonic Ecology Systems Guangdong Co., Ltd.  
2 South Chaogui Road,  
Shunde High-Tech Industrial Zone (Ronggui),  
Foshan, Guangdong, P.R.China 528306, CHINA

[74] MARKS & CLERK

Level 9, Cyberport 1,  
100 Cyberport Road,  
Pok Fu Lam, Hong Kong.



---

[11] 1802078.6M002

[15] 18-10-2018

[30] 08-05-2018 / CN / 201830203119.8

[51] Cl. 14-04

[54] 用於遙控面板的圖形用戶界面

The remote control panel with a graphical user interface

[73] 廣東松下環境系統有限公司

Panasonic Ecology Systems Guangdong Co., Ltd.

2 South Chaogui Road, Shunde High-Tech Industrial Zone

(Ronggui), Foshan, Guangdong, P.R.China 528306, CHINA

[74] MARKS & CLERK

Level 9, Cyberport 1, 100 Cyberport Road, Pok Fu Lam, Hong

Kong.



---

[11] 1802078.6M003

[15] 18-10-2018

[30] 08-05-2018 / CN / 201830203119.8

[51] Cl. 14-04

[54] 用於遙控面板的圖形用戶界面

The remote control panel with a graphical user interface

[73] 廣東松下環境系統有限公司

Panasonic Ecology Systems Guangdong Co., Ltd.

2 South Chaogui Road, Shunde High-Tech Industrial Zone

(Ronggui), Foshan, Guangdong, P.R.China 528306, CHINA

[74] MARKS & CLERK

Level 9, Cyberport 1, 100 Cyberport Road, Pok Fu Lam, Hong

Kong.



---

[11] 1802078.6M004



[15] 18-10-2018

[30] 08-05-2018 / CN / 201830203119.8

[51] Cl. 14-04

[54] 用於遙控面板的圖形用戶界面

The remote control panel with a graphical user interface

[73] 廣東松下環境系統有限公司

Panasonic Ecology Systems Guangdong Co., Ltd.

2 South Chaogui Road, Shunde High-Tech Industrial Zone

(Ronggui), Foshan, Guangdong, P.R.China 528306, CHINA

[74] MARKS & CLERK

Level 9, Cyberport 1, 100 Cyberport Road, Pok Fu Lam, Hong

Kong.



---

[11] 1802078.6M005

[15] 18-10-2018

[30] 08-05-2018 / CN / 201830203119.8

[51] Cl. 14-04

[54] 用於遙控面板的圖形用戶界面

The remote control panel with a graphical user interface

[73] 廣東松下環境系統有限公司

Panasonic Ecology Systems Guangdong Co., Ltd.

2 South Chaogui Road, Shunde High-Tech Industrial Zone

(Ronggui), Foshan, Guangdong, P.R.China 528306, CHINA

[74] MARKS & CLERK

Level 9, Cyberport 1, 100 Cyberport Road, Pok Fu Lam, Hong

Kong.



---

[11] 1802078.6M006

[15] 18-10-2018

[30] 08-05-2018 / CN / 201830203119.8

[51] Cl. 14-04

[54] 用於遙控面板的圖形用戶界面

The remote control panel with a graphical user interface

[73] 廣東松下環境系統有限公司

Panasonic Ecology Systems Guangdong Co., Ltd.

2 South Chaogui Road, Shunde High-Tech Industrial Zone

(Ronggui), Foshan, Guangdong, P.R.China 528306, CHINA

[74] MARKS & CLERK

Level 9, Cyberport 1, 100 Cyberport Road, Pok Fu Lam, Hong

Kong.



---

[11] 1802078.6M007

[15] 18-10-2018

[30] 08-05-2018 / CN / 201830203119.8

[51] Cl. 14-04

[54] 用於遙控面板的圖形用戶界面

The remote control panel with a graphical user interface

[73] 廣東松下環境系統有限公司

Panasonic Ecology Systems Guangdong Co., Ltd.

2 South Chaogui Road, Shunde High-Tech Industrial Zone

(Ronggui), Foshan, Guangdong, P.R.China 528306, CHINA

[74] MARKS & CLERK

Level 9, Cyberport 1, 100 Cyberport Road, Pok Fu Lam, Hong

Kong.



---

[11] 1802102.8M001

- [15] 22-10-2018
- [30] 04-06-2018 / CN / 201830274426.5
- [51] Cl. 2-01
- [54] 內褲  
Underpants
- [73] 安莉芳(中國)服裝有限公司  
Embry (China) Garments Limited  
5th Floor East, Block A, Cuishan Industrial Area, 2063  
Jindaotian Road;  
14th Floor West, 17th and 18th Floors, Block B, CMEC Plaza,  
No.1028 Buji Road, Dongxiao Street, Luohu District, Shenzhen,  
CHINA
- [74] Spruson & Ferguson (Hong Kong) Limited  
5001 Hopewell Centre,  
183 Queen's Road East,  
Hong Kong.



- 
- [11] 1802102.8M002
- [15] 22-10-2018
- [30] 04-06-2018 / CN / 201830274427.X
- [51] Cl. 2-01
- [54] 胸罩  
Brassiere
- [73] 安莉芳(中國)服裝有限公司  
Embry (China) Garments Limited  
5th Floor East, Block A, Cuishan Industrial Area, 2063  
Jindaotian Road;  
14th Floor West, 17th and 18th Floors, Block B, CMEC Plaza,  
No.1028 Buji Road, Dongxiao Street, Luohu District, Shenzhen,  
CHINA
- [74] Spruson & Ferguson (Hong Kong) Limited  
5001 Hopewell Centre,  
183 Queen's Road East,  
Hong Kong.



---

[11] 1802102.8M003

[15] 22-10-2018

[30] 04-06-2018 / CN / 201830274428.4

[51] Cl. 2-01

[54] 胸罩

Brassiere

[73] 安莉芳(中國)服裝有限公司

Embry (China) Garments Limited

5th Floor East, Block A, Cuishan Industrial Area, 2063

Jindaotian Road;

14th Floor West, 17th and 18th Floors, Block B, CMEC Plaza,

No.1028 Buji Road, Dongxiao Street, Luohu District, Shenzhen,

CHINA

[74] Spruson & Ferguson (Hong Kong) Limited

5001 Hopewell Centre,

183 Queen's Road East,

Hong Kong.



---

[11] 1802103.0M001

[15] 23-10-2018

[51] Cl. 26-05

[54] 燈

Lamp

[73] C.G. Lighting Ltd.

Rm. 1601 Wanchai Commercial Centre,  
194 Johnston Road, Wanchai,  
Hong Kong

[74] C.G. Lighting Ltd.

Rm. 1601 Wanchai Commercial Centre,  
194 Johnston Road, Wanchai,  
Hong Kong

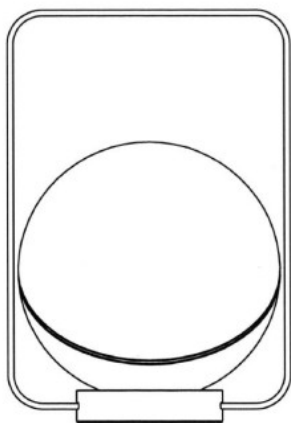

---

[11] 1802103.0M002

[15] 23-10-2018

[51] Cl. 26-05

[54] 燈

Lamp

[73] C.G. Lighting Ltd.

Rm. 1601 Wanchai Commercial Centre,  
194 Johnston Road, Wanchai,  
Hong Kong

[74] C.G. Lighting Ltd.

Rm. 1601 Wanchai Commercial Centre,  
194 Johnston Road, Wanchai,  
Hong Kong



---

[11] 1802103.0M003

[15] 23-10-2018

[51] Cl. 26-05

[54] 燈

Lamp

[73] C.G. Lighting Ltd.

Rm. 1601 Wanchai Commercial Centre,  
194 Johnston Road, Wanchai,  
Hong Kong

[74] C.G. Lighting Ltd.

Rm. 1601 Wanchai Commercial Centre,  
194 Johnston Road, Wanchai,  
Hong Kong

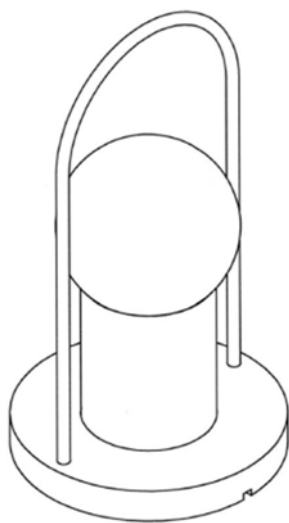

---

[11] 1802103.0M004

[15] 23-10-2018

[51] Cl. 26-05

[54] 燈

Lamp

[73] C.G. Lighting Ltd.

Rm. 1601 Wanchai Commercial Centre,  
194 Johnston Road, Wanchai,  
Hong Kong

[74] C.G. Lighting Ltd.

Rm. 1601 Wanchai Commercial Centre,  
194 Johnston Road, Wanchai,  
Hong Kong

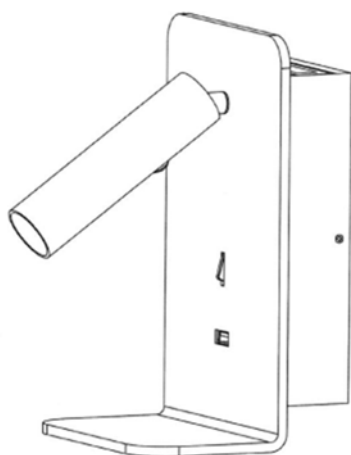

---

[11] 1802103.0M005

[15] 23-10-2018

[51] Cl. 26-05

[54] 燈

Lamp

[73] C.G. Lighting Ltd.

Rm. 1601 Wanchai Commercial Centre,  
194 Johnston Road, Wanchai,  
Hong Kong

[74] C.G. Lighting Ltd.

Rm. 1601 Wanchai Commercial Centre,  
194 Johnston Road, Wanchai,  
Hong Kong

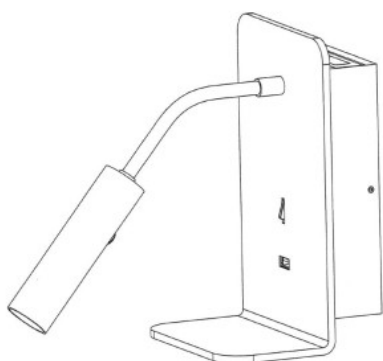

---

[11] 1802103.0M006

[15] 23-10-2018

[51] Cl. 26-05

[54] 燈

Lamp

[73] C.G. Lighting Ltd.

Rm. 1601 Wanchai Commercial Centre,  
194 Johnston Road, Wanchai,  
Hong Kong

[74] C.G. Lighting Ltd.

Rm. 1601 Wanchai Commercial Centre,  
194 Johnston Road, Wanchai,  
Hong Kong

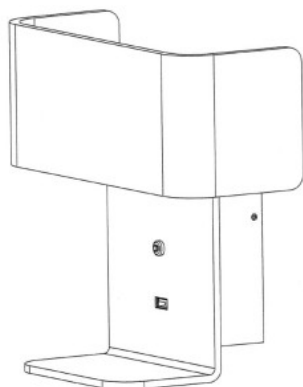

---

[11] 1802103.0M007

[15] 23-10-2018

[51] Cl. 26-05



[54] 燈

Lamp

[73] C.G. Lighting Ltd.

Rm. 1601 Wanchai Commercial Centre,  
194 Johnston Road, Wanchai,  
Hong Kong

[74] C.G. Lighting Ltd.

Rm. 1601 Wanchai Commercial Centre,  
194 Johnston Road, Wanchai,  
Hong Kong

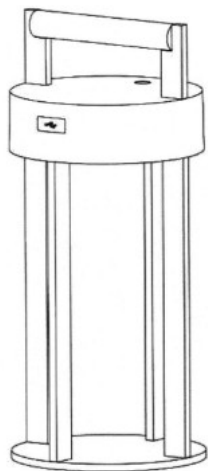

---

[11] 1802103.0M008

[15] 23-10-2018

[51] Cl. 26-05

[54] 燈

Lamp

[73] C.G. Lighting Ltd.

Rm. 1601 Wanchai Commercial Centre,  
194 Johnston Road, Wanchai,  
Hong Kong

[74] C.G. Lighting Ltd.

Rm. 1601 Wanchai Commercial Centre,  
194 Johnston Road, Wanchai,  
Hong Kong

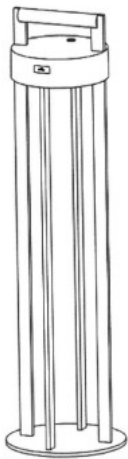

---

[11] 1802103.0M009

[15] 23-10-2018

[51] Cl. 26-05

[54] 燈

Lamp

[73] C.G. Lighting Ltd.

Rm. 1601 Wanchai Commercial Centre,  
194 Johnston Road, Wanchai,  
Hong Kong

[74] C.G. Lighting Ltd.

Rm. 1601 Wanchai Commercial Centre,  
194 Johnston Road, Wanchai,  
Hong Kong

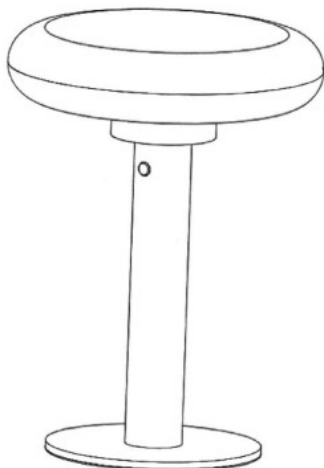

---

[11] 1802103.0M010

[15] 23-10-2018

[51] Cl. 26-05

[54] 燈

Lamp

[73] C.G. Lighting Ltd.

Rm. 1601 Wanchai Commercial Centre,  
194 Johnston Road, Wanchai,  
Hong Kong

[74] C.G. Lighting Ltd.

Rm. 1601 Wanchai Commercial Centre,  
194 Johnston Road, Wanchai,  
Hong Kong

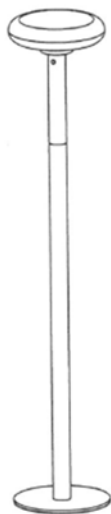

---

[11] 1802103.0M011

[15] 23-10-2018

[51] Cl. 26-05

[54] 燈

Lamp

[73] C.G. Lighting Ltd.

Rm. 1601 Wanchai Commercial Centre,  
194 Johnston Road, Wanchai,  
Hong Kong

[74] C.G. Lighting Ltd.

Rm. 1601 Wanchai Commercial Centre,  
194 Johnston Road, Wanchai,  
Hong Kong

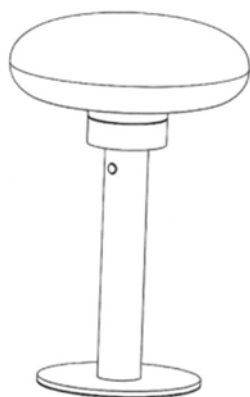

---

[11] 1802103.0M012

[15] 23-10-2018

[51] Cl. 26-05

[54] 燈

Lamp

[73] C.G. Lighting Ltd.

Rm. 1601 Wanchai Commercial Centre,  
194 Johnston Road, Wanchai,  
Hong Kong

[74] C.G. Lighting Ltd.

Rm. 1601 Wanchai Commercial Centre,  
194 Johnston Road, Wanchai,  
Hong Kong



---

[11] 1802103.0M013

[15] 23-10-2018

[51] Cl. 26-05

[54] 燈

Lamp

[73] C.G. Lighting Ltd.

Rm. 1601 Wanchai Commercial Centre,  
194 Johnston Road, Wanchai,  
Hong Kong

[74] C.G. Lighting Ltd.

Rm. 1601 Wanchai Commercial Centre,  
194 Johnston Road, Wanchai,  
Hong Kong

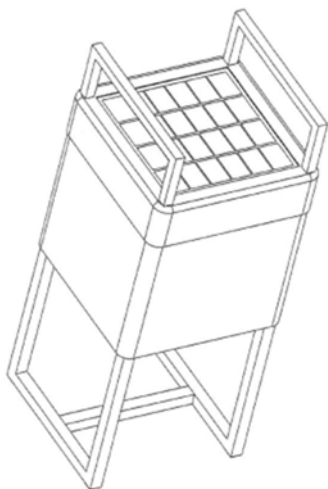

---

[11] 1802103.0M014

[15] 23-10-2018

[51] Cl. 26-05

[54] 燈

Lamp

[73] C.G. Lighting Ltd.

Rm. 1601 Wanchai Commercial Centre,  
194 Johnston Road, Wanchai,  
Hong Kong

[74] C.G. Lighting Ltd.

Rm. 1601 Wanchai Commercial Centre,  
194 Johnston Road, Wanchai,  
Hong Kong



---

[11] 1802104.2M001

[15] 23-10-2018

[30] 23-04-2018 / US / 29/645,081

[51] Cl. 14-03

[54] 電子裝置

Electronic device

[73] 蘋果公司

APPLE INC.

ONE APPLE PARK WAY, CUPERTINO,

CALIFORNIA 95014, U.S.A.

UNITED STATES

[74] CLT Patent & Trademark (H.K.) Ltd.

Unit 09, 34/F., Office Tower, Convention Plaza,

No. 1 Harbour Road, Wanchai,

Hong Kong.



---

[11] 1802104.2M002

[15] 23-10-2018

[30] 23-04-2018 / US / 29/645,081

[51] Cl. 14-03

[54] 電子裝置  
Electronic device

[73] 蘋果公司  
APPLE INC.  
ONE APPLE PARK WAY, CUPERTINO,  
CALIFORNIA 95014, U.S.A.  
UNITED STATES

[74] CLT Patent & Trademark (H.K.) Ltd.  
Unit 09, 34/F., Office Tower, Convention Plaza,  
No. 1 Harbour Road, Wanchai,  
Hong Kong.



---

[11] 1802104.2M003

[15] 23-10-2018

[30] 23-04-2018 / US / 29/645,081

[51] Cl. 14-03

[54] 電子裝置  
Electronic device

[73] 蘋果公司  
APPLE INC.  
ONE APPLE PARK WAY, CUPERTINO,  
CALIFORNIA 95014, U.S.A.  
UNITED STATES

[74] CLT Patent & Trademark (H.K.) Ltd.  
Unit 09, 34/F., Office Tower, Convention Plaza,  
No. 1 Harbour Road, Wanchai,  
Hong Kong.



[11] 1802104.2M004

[15] 23-10-2018

[30] 23-04-2018 / US / 29/645,081

[51] Cl. 14-03

[54] 電子裝置

Electronic device

[73] 蘋果公司

APPLE INC.

ONE APPLE PARK WAY, CUPERTINO,

CALIFORNIA 95014, U.S.A.

UNITED STATES

[74] CLT Patent & Trademark (H.K.) Ltd.

Unit 09, 34/F., Office Tower, Convention Plaza,

No. 1 Harbour Road, Wanchai,

Hong Kong.



---

[11] 1802104.2M005

[15] 23-10-2018

[30] 23-04-2018 / US / 29/645,081

[51] Cl. 14-03

[54] 電子裝置

Electronic device

[73] 蘋果公司

APPLE INC.

ONE APPLE PARK WAY, CUPERTINO,

CALIFORNIA 95014, U.S.A.

UNITED STATES

[74] CLT Patent & Trademark (H.K.) Ltd.

Unit 09, 34/F., Office Tower, Convention Plaza,

No. 1 Harbour Road, Wanchai,

Hong Kong.





---

[11] 1802104.2M006

[15] 23-10-2018

[30] 23-04-2018 / US / 29/645,081

[51] Cl. 14-03

[54] 電子裝置

Electronic device

[73] 蘋果公司

APPLE INC.

ONE APPLE PARK WAY, CUPERTINO,

CALIFORNIA 95014, U.S.A.

UNITED STATES

[74] CLT Patent & Trademark (H.K.) Ltd.

Unit 09, 34/F., Office Tower, Convention Plaza,

No. 1 Harbour Road, Wanchai,

Hong Kong.



---

[11] 1802104.2M007

[15] 23-10-2018

[30] 23-04-2018 / US / 29/645,081

[51] Cl. 14-03

[54] 電子裝置

Electronic device

[73] 蘋果公司

APPLE INC.

ONE APPLE PARK WAY, CUPERTINO,

CALIFORNIA 95014, U.S.A.

UNITED STATES

- [74] CLT Patent & Trademark (H.K.) Ltd.  
Unit 09, 34/F., Office Tower, Convention Plaza,  
No. 1 Harbour Road, Wanchai,  
Hong Kong.



---

[11] 1802104.2M008

[15] 23-10-2018

[30] 23-04-2018 / US / 29/645,081

[51] Cl. 14-03

[54] 電子裝置

Electronic device

[73] 蘋果公司

APPLE INC.

ONE APPLE PARK WAY, CUPERTINO,

CALIFORNIA 95014, U.S.A.

UNITED STATES

- [74] CLT Patent & Trademark (H.K.) Ltd.  
Unit 09, 34/F., Office Tower, Convention Plaza,  
No. 1 Harbour Road, Wanchai,  
Hong Kong.



---

[11] 1802105.5M001

[15] 23-10-2018

[30] 23-04-2018 / US / 29/645,082

[51] Cl. 14-03

[54] 電子裝置

Electronic device

[73] 蘋果公司

APPLE INC.  
ONE APPLE PARK WAY, CUPERTINO,  
CALIFORNIA 95014, U.S.A.  
UNITED STATES

[74] CLT Patent & Trademark (H.K.) Ltd.

Unit 09, 34/F., Office Tower, Convention Plaza,  
No. 1 Harbour Road, Wanchai,  
Hong Kong.



---

[11] 1802105.5M002

[15] 23-10-2018

[30] 23-04-2018 / US / 29/645,082

[51] Cl. 14-03

[54] 電子裝置

Electronic device

[73] 蘋果公司

APPLE INC.  
ONE APPLE PARK WAY, CUPERTINO,  
CALIFORNIA 95014, U.S.A.  
UNITED STATES

[74] CLT Patent & Trademark (H.K.) Ltd.

Unit 09, 34/F., Office Tower, Convention Plaza,  
No. 1 Harbour Road, Wanchai,  
Hong Kong.



---

[11] 1802109.3M001

[15] 24-10-2018

[30] 19-08-2018 / IL / 62606

[51] Cl. 21-01

[54] 水玩玩具

Water toy

[73] GLOBAL MARKETING ENTERPRISE (GME) LTD.

P.O.B 25202,

TEL AVIV 6125101,

ISRAEL

[74] Woo Kwan Lee & Lo

Room 2801, Sun Hung Kai Centre,

30 Harbour Road, Wanchai,

Hong Kong.



---

[11] 1802109.3M002

[15] 24-10-2018

[30] 09-08-2018 / IL / 62520

[51] Cl. 21-01

[54] 水玩玩具

Water toy

[73] GLOBAL MARKETING ENTERPRISE (GME) LTD.

P.O.B 25202,

TEL AVIV 6125101,

ISRAEL

[74] Woo Kwan Lee & Lo

Room 2801, Sun Hung Kai Centre,

30 Harbour Road, Wanchai,

Hong Kong.



---

[11] 1802115.6M001

[15] 25-10-2018

[30] 26-04-2018 / DE / 40 2018 201 506.0

[51] Cl. 2-04

[54] 鞋

Shoe

[73] Birkenstock Sales GmbH

Rheinstraße 10,

53560 Vettelschoss,

GERMANY

[74] Deacons

5th Floor,

Alexandra House,

Central, Hong Kong.



---

[11] 1802115.6M002

[15] 25-10-2018

[30] 26-04-2018 / DE / 40 2018 201 506.0

[51] Cl. 2-04

[54] 鞋

Shoe

[73] Birkenstock Sales GmbH

Rheinstraße 10, 53560 Vettelschoss, GERMANY

- [74] Deacons  
5th Floor, Alexandra House, Central, Hong Kong.



- 
- [11] 1802117.0  
[15] 25-10-2018  
[51] Cl. 8-04  
[54] 螺絲批  
Screwdriver  
[73] 領先洋行有限公司  
WINLY TRADING COMPANY LIMITED  
香港九龍觀塘 開源  
道 62 號二期  
駱駝漆大廈 4 樓 D 室  
[74] WINLY TRADING COMPANY LIMITED  
香港九龍觀塘 開源  
道 62 號二期  
駱駝漆大廈 4 樓 D 室

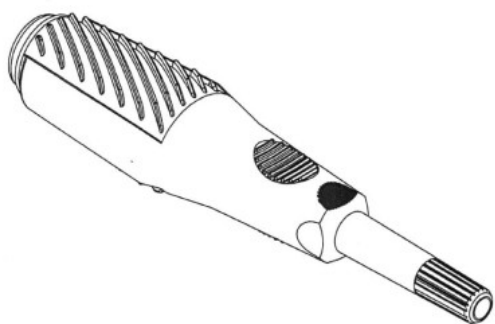

- 
- [11] 1802123.2M001  
[15] 26-10-2018  
[30] 26-04-2018 / JP / 009340 of 2018  
[51] Cl. 10-04  
[54] 身體尺寸測量工具  
Measuring tool of body size

[73] ZOZO, INC.  
2-6-1, NAKASE, MIHAMA-KU,  
CHIBA-SHI, CHIBA 2617116,  
JAPAN

[74] CLT Patent & Trademark (H.K.) Ltd.  
Unit 09, 34/F., Office Tower, Convention Plaza,  
No. 1 Harbour Road, Wanchai,  
Hong Kong.



---

[11] 1802123.2M002

[15] 26-10-2018

[30] 26-04-2018 / JP / 009341 of 2018

[51] Cl. 10-04

[54] 身體尺寸測量工具

Measuring tool of body size

[73] ZOZO, INC.  
2-6-1, NAKASE, MIHAMA-KU,  
CHIBA-SHI, CHIBA 2617116,  
JAPAN

[74] CLT Patent & Trademark (H.K.) Ltd.  
Unit 09, 34/F., Office Tower, Convention Plaza,  
No. 1 Harbour Road, Wanchai,  
Hong Kong.



---

[11] 1802123.2M003

[15] 26-10-2018

[30] 26-04-2018 / JP / 009342 of 2018

[51] Cl. 10-04

[54] 身體尺寸測量工具

Measuring tool of body size

[73] ZOZO, INC.  
2-6-1, NAKASE, MIHAMA-KU,

CHIBA-SHI, CHIBA 2617116,  
JAPAN

- [74] CLT Patent & Trademark (H.K.) Ltd.  
Unit 09, 34/F., Office Tower, Convention Plaza,  
No. 1 Harbour Road, Wanchai,  
Hong Kong.

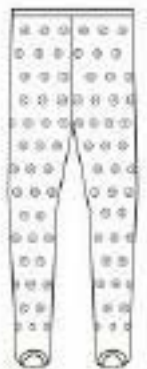

- 
- [11] 1802123.2M004  
[15] 26-10-2018  
[30] 26-04-2018 / JP / 009343 of 2018  
[51] Cl. 10-04  
[54] 身體尺寸測量工具  
Measuring tool of body size  
[73] ZOZO, INC.  
2-6-1, NAKASE, MIHAMA-KU,  
CHIBA-SHI, CHIBA 2617116,  
JAPAN

- [74] CLT Patent & Trademark (H.K.) Ltd.  
Unit 09, 34/F., Office Tower, Convention Plaza,  
No. 1 Harbour Road, Wanchai,  
Hong Kong.

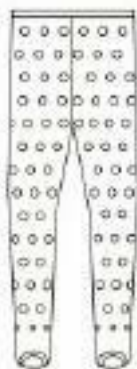



[11] 1802133.3M001

[15] 29-10-2018

[51] Cl. 23-04

[54] 風扇

Fan

[73] Well Plus Technology Development Limited

13/Floor, Harbour Commercial Building,

122-124 Connaught Road, Central,

Sheung Wan, Hong Kong

[74] Federation of Hong Kong Industries

31/F, Billion Plaza,

8 Cheung Yue Street,

Cheung Sha Wan, Kowloon, Hong Kong.



---

[11] 1802133.3M002

[15] 29-10-2018

[51] Cl. 23-04

[54] 風扇

Fan

[73] Well Plus Technology Development Limited

13/Floor, Harbour Commercial Building,

122-124 Connaught Road, Central,

Sheung Wan, Hong Kong

[74] Federation of Hong Kong Industries

31/F, Billion Plaza,

8 Cheung Yue Street,

Cheung Sha Wan, Kowloon, Hong Kong.



---

[11] 1802134.5M001

[15] 30-10-2018

[30] 04-05-2018 / EM / 005258746

[51] Cl. 28-03

[54] 剃鬚器  
Shaver

[73] Koninklijke Philips N.V.  
High Tech Campus 5,  
5656 AE, Eindhoven,  
NETHERLANDS

[74] Wilkinson & Grist  
6th Floor, Prince's Building,  
Chater Road,  
Hong Kong.



---

[11] 1802134.5M002

[15] 30-10-2018

[30] 04-05-2018 / EM / 005258746

[51] Cl. 28-03

[54] 剃鬚器  
Shaver

[73] Koninklijke Philips N.V.  
High Tech Campus 5,  
5656 AE, Eindhoven,  
NETHERLANDS

[74] Wilkinson & Grist  
6th Floor, Prince's Building,  
Chater Road,  
Hong Kong.



---

[11] 1802134.5M003

[15] 30-10-2018

[30] 04-05-2018 / EM / 005258746

[51] Cl. 28-03

[54] 剃鬚器  
Shaver

[73] Koninklijke Philips N.V.  
High Tech Campus 5,  
5656 AE, Eindhoven,  
NETHERLANDS

[74] Wilkinson & Grist  
6th Floor, Prince's Building,  
Chater Road,  
Hong Kong.



[11] 1802134.5M004

[15] 30-10-2018

[30] 04-05-2018 / EM / 005258746

[51] Cl. 28-03

[54] 剃鬚器手柄

Handle for shaver

[73] Koninklijke Philips N.V.

High Tech Campus 5,

5656 AE, Eindhoven,

NETHERLANDS

[74] Wilkinson & Grist

6th Floor, Prince's Building,

Chater Road,

Hong Kong.



---

[11] 1802134.5M005

[15] 30-10-2018

[30] 04-05-2018 / EM / 005258746

[51] Cl. 28-03

[54] 剃鬚器手柄

Handle for shaver

[73] Koninklijke Philips N.V.

High Tech Campus 5,

5656 AE, Eindhoven,

NETHERLANDS

[74] Wilkinson & Grist

6th Floor, Prince's Building,

Chater Road,

Hong Kong.



---

[11] 1802134.5M006

[15] 30-10-2018

[30] 04-05-2018 / EM / 005258746

[51] Cl. 28-03

[54] 剃鬚器手柄

Handle for shaver

[73] Koninklijke Philips N.V.

High Tech Campus 5,

5656 AE, Eindhoven,

NETHERLANDS

[74] Wilkinson & Grist

6th Floor, Prince's Building,

Chater Road,

Hong Kong.



---

[11] 1802134.5M007

[15] 30-10-2018

[30] 04-05-2018 / EM / 005258746

[51] Cl. 28-03

[54] 剃鬚器手柄

Handle for shaver

[73] Koninklijke Philips N.V.  
High Tech Campus 5,  
5656 AE, Eindhoven,  
NETHERLANDS

[74] Wilkinson & Grist  
6th Floor, Prince's Building,  
Chater Road,  
Hong Kong.



---

[11] 1802134.5M008

[15] 30-10-2018

[30] 04-05-2018 / EM / 005258746

[51] Cl. 28-03

[54] 剃鬚器手柄

Handle for shaver

[73] Koninklijke Philips N.V.  
High Tech Campus 5,  
5656 AE, Eindhoven,  
NETHERLANDS

[74] Wilkinson & Grist  
6th Floor, Prince's Building,  
Chater Road,  
Hong Kong.



- [11] 1802134.5M009  
[15] 30-10-2018  
[30] 04-05-2018 / EM / 005258746  
[51] Cl. 28-03  
[54] 剃鬚器手柄  
Handle for shaver  
[73] Koninklijke Philips N.V.  
High Tech Campus 5,  
5656 AE, Eindhoven,  
NETHERLANDS  
[74] Wilkinson & Grist  
6th Floor, Prince's Building,  
Chater Road,  
Hong Kong.



- [11] 1802134.5M010  
[15] 30-10-2018  
[30] 04-05-2018 / EM / 005258746  
[51] Cl. 28-03  
[54] 剃鬚器手柄  
Handle for shaver  
[73] Koninklijke Philips N.V.  
High Tech Campus 5,  
5656 AE, Eindhoven,  
NETHERLANDS  
[74] Wilkinson & Grist  
6th Floor, Prince's Building,  
Chater Road,  
Hong Kong.



---

[11] 1802134.5M011

[15] 30-10-2018

[30] 04-05-2018 / EM / 005258746

[51] Cl. 28-03

[54] 剃鬚器手柄

Handle for shaver

[73] Koninklijke Philips N.V.

High Tech Campus 5,

5656 AE, Eindhoven,

NETHERLANDS

[74] Wilkinson & Grist

6th Floor, Prince's Building,

Chater Road,

Hong Kong.



---

[11] 1802134.5M012

[15] 30-10-2018

[30] 04-05-2018 / EM / 005258746

[51] Cl. 28-03

[54] 剃鬚器手柄

Handle for shaver



[73] Koninklijke Philips N.V.  
High Tech Campus 5,  
5656 AE, Eindhoven,  
NETHERLANDS

[74] Wilkinson & Grist  
6th Floor, Prince's Building,  
Chater Road,  
Hong Kong.



---

[11] 1802134.5M013

[15] 30-10-2018

[30] 04-05-2018 / EM / 005258746

[51] Cl. 28-03

[54] 剃鬚器手柄

Handle for shaver

[73] Koninklijke Philips N.V.  
High Tech Campus 5,  
5656 AE, Eindhoven,  
NETHERLANDS

[74] Wilkinson & Grist  
6th Floor, Prince's Building,  
Chater Road,  
Hong Kong.



[11] 1802134.5M014

[15] 30-10-2018

[30] 04-05-2018 / EM / 005258746

[51] Cl. 28-03

[54] 剃鬚器手柄

Handle for shaver

[73] Koninklijke Philips N.V.

High Tech Campus 5,

5656 AE, Eindhoven,

NETHERLANDS

[74] Wilkinson & Grist

6th Floor, Prince's Building,

Chater Road,

Hong Kong.



---

[11] 1802134.5M015

[15] 30-10-2018

[30] 04-05-2018 / EM / 005258746

[51] Cl. 28-03

[54] 剃鬚器設備

Shaving unit

[73] Koninklijke Philips N.V.

High Tech Campus 5,

5656 AE, Eindhoven,

NETHERLANDS

[74] Wilkinson & Grist

6th Floor, Prince's Building,

Chater Road,

Hong Kong.



---

[11] 1802139.6

[15] 31-10-2018

[30] 11-05-2018 / CN / 201830215275.6

[51] Cl. 28-03

[54] 頸部按摩器

Neck massager

[73] 深圳市倍輕鬆科技股份有限公司

中國內地廣東省深圳市 南山區

創業路 1777 號

海信南方大廈 19 樓

[74] 中一聯合國際知識產權有限公司

香港九龍尖沙咀

漆咸道南 45-51 號

其士大廈 803 室

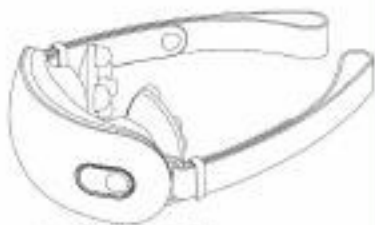

---

[11] 1802142.2M001

[15] 31-10-2018

[30] 06-06-2018 / EM, JP, KR, CH / DM/101 732

[51] Cl. 11-01

[54] 介指

Ring

[73] Cartier International AG

Hinterbergstrasse 22,

6312 STEINHAUSEN,

SWITZERLAND

- [74] Deacons  
5th Floor,  
Alexandra House,  
Central, Hong Kong.



- 
- [11] 1802142.2M002  
[15] 31-10-2018  
[30] 06-06-2018 / EM, JP, KR, CH / DM/101 732  
[51] Cl. 11-01

- [54] 鐲子  
Bracelet

- [73] Cartier International AG  
Hinterbergstrasse 22,  
6312 STEINHAUSEN,  
SWITZERLAND

- [74] Deacons  
5th Floor,  
Alexandra House,  
Central, Hong Kong.



- 
- [11] 1802143.4  
[15] 31-10-2018  
[30] 14-06-2018 / EM / 005310000  
[51] Cl. 31-00  
[54] 製意大利麵機  
Pasta maker

[73] Koninklijke Philips N.V.  
High Tech Campus 5,  
5656 AE Eindhoven,  
NETHERLANDS

[74] Wilkinson & Grist  
6th Floor, Prince's Building,  
Chater Road,  
Hong Kong.



---

[11] 1802144.6M001

[15] 31-10-2018

[30] 04-05-2018 / EM / 005257136

[51] C1. 28-03

[54] 牙刷手柄

Toothbrush handle

[73] Koninklijke Philips N.V.  
High Tech Campus 5,  
5656 AE Eindhoven,  
NETHERLANDS

[74] Wilkinson & Grist  
6th Floor, Prince's Building,  
Chater Road,  
Hong Kong.



[11] 1802144.6M002

[15] 31-10-2018

[30] 04-05-2018 / EM / 005257144

[51] Cl. 28-03

[54] 牙刷手柄連刷頭

Toothbrush handle with brush head

[73] Koninklijke Philips N.V.

High Tech Campus 5,

5656 AE Eindhoven,

NETHERLANDS

[74] Wilkinson & Grist

6th Floor, Prince's Building,

Chater Road,

Hong Kong.



---

[11] 1802145.9

[15] 31-10-2018

[51] Cl. 28-03

[54] 化妝品用包裝容器

Packaging container for cosmetic use

[73] AMOREPACIFIC CORPORATION

100, Hangang-daero,

Yongsan-gu, Seoul,

KOREA, REPUBLIC OF

[74] TrademarkCN. Co. Ltd.

Blk. A, 4/F, Granville Building,

14 Granville Road, T.S.T.,

Kowloon, Hong Kong.



---

[11] 1802146.1

[15] 31-10-2018

[30] 15-05-2018 / ES / D0528321

[51] Cl. 13-03

[54] 插座

Socket

[73] 西蒙獨資有限公司

SIMON, S.A.U.

390-392th Avenue,

Suite C, Barcelona,

SPAIN

[74] CHINAHONGKONG IP LIMITED

3011, 30/F, Office Tower,

Convention Plaza, 1 Harbour Road,

Hong Kong.

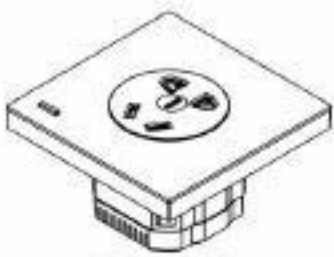

---

[11] 1802147.3

[15] 31-10-2018

[30] 15-05-2018 / ES / D0528321

[51] Cl. 13-03

[54] 插座

Socket

[73] 西蒙獨資有限公司

SIMON, S.A.U.

390-392th Avenue,  
Suite C, Barcelona,  
SPAIN

- [74] CHINAHONGKONG IP LIMITED  
3011, 30/F, Office Tower,  
Convention Plaza, 1 Harbour Road,  
Hong Kong.

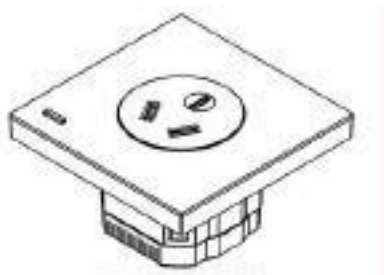

- 
- [11] 1802149.7  
[15] 01-11-2018  
[30] 09-07-2018 / JP / 015052 of 2018  
[51] Cl. 12-08  
[54] 汽車  
Automobile

- [73] TOYOTA JIDOSHA KABUSHIKI KAISHA  
1, Toyota-cho,  
Toyota-shi, Aichi-ken,  
471-8571, JAPAN  
[74] CLT Patent & Trademark (H.K.) Ltd.  
Unit 09, 34/F., Office Tower, Convention Plaza,  
No. 1 Harbour Road, Wanchai,  
Hong Kong.



- 
- [11] 1802150.9  
[15] 01-11-2018  
[30] 02-05-2018 / JP / 009779 of 2018  
[51] Cl. 11-01  
[54] 寶石  
Gemstone



[73] TOKYO PEARL CO., LTD.  
6-16-3 GINZA, CHUO-KU,  
TOKYO 104-0061,  
JAPAN

[74] China Patent Agent (H.K.) Ltd.  
22/F, Great Eagle Centre,  
23 Harbour Road, Wanchai,  
Hong Kong.



---

[11] 1802151.1

[15] 01-11-2018

[51] Cl. 9-09

[54] 垃圾桶

Dustbin

[73] Fullhouse World Holdings Limited  
10/F., SOUTHEAST INDUSTRIAL BUILDING,  
611-619 CASTLE PEAK ROAD, TSUEN WAN,  
NEW TERRITORIES, HONG KONG

[74] HONG KONG INTELLECTUAL PROPERTY ADVISORY SERVICE LIMITED  
UNIT 1701, 17/F., EW INTERNATIONAL TOWER,  
120 TEXACO ROAD, TSUEN WAN,  
NEW TERRITORIES, HONG KONG



---

[11] 1802240.0M001

[15] 16-11-2018

[30] 07-06-2018 / US / 29/650,592

[51] Cl. 13-03

[54] 轉接器

Adapter

[73] 蘋果公司

APPLE INC.  
ONE APPLE PARK WAY, CUPERTINO,  
CALIFORNIA 95014, U.S.A.  
UNITED STATES

[74] CLT Patent & Trademark (H.K.) Ltd.

Unit 09, 34/F., Office Tower, Convention Plaza,  
No. 1 Harbour Road, Wanchai,  
Hong Kong.

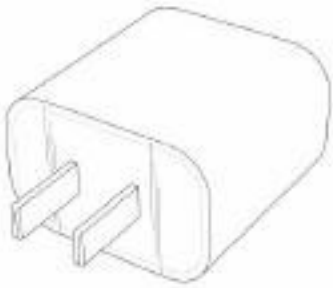

---

[11] 1802240.0M002

[15] 16-11-2018

[30] 07-06-2018 / US / 29/650,592

[51] Cl. 13-03

[54] 轉接器

Adapter

[73] 蘋果公司

APPLE INC.  
ONE APPLE PARK WAY, CUPERTINO,  
CALIFORNIA 95014, U.S.A.  
UNITED STATES

[74] CLT Patent & Trademark (H.K.) Ltd.

Unit 09, 34/F., Office Tower, Convention Plaza,  
No. 1 Harbour Road, Wanchai,  
Hong Kong.

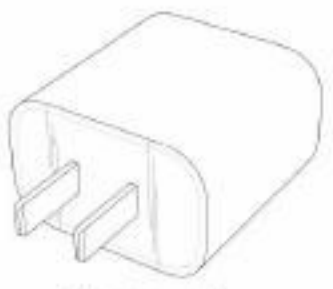



香港特別行政區政府知識產權署外觀設計註冊處

The Government of the Hong Kong Special Administrative

Region Designs Registry, Intellectual Property

Department

**根據註冊外觀設計條例第 28 條，下列註冊外觀設計因未繳續期費而停止有效。各組記項按註冊外觀設計停止有效日期及註冊編號先後次序排列。**

**Registered designs ceased through non-payment of renewal fees under section**

**28 of the Registered Designs Ordinance. Entries are listed below under their expiry dates.**

**01-05-2019 - 09-05-2019**

<b>01-05-2019</b>	1400834.4M002	1400849.6
1400819.3M001	1400835.7M001	1400850.8
1400819.3M002	1400835.7M002	9910536.7M002
1400819.3M003	1400836.9	9910539.3
1400820.5M001	1400837.1	
1400820.5M002	1400838.3	
1400820.5M003	1400839.5	
1400821.7M001	1400840.7	
1400821.7M002	1400841.9	
1400821.7M003		
1400821.7M004	<b>05-05-2019</b>	
1400821.7M005	0900725.7M001	0411001.9
1400821.7M006	0900725.7M002	0411002.1M001
1400821.7M007	0900726.9M001	0411002.1M002
1400828.2	0900726.9M002	0900738.4
1400829.4M001	0900726.9M003	0900739.6
1400829.4M002	0900726.9M004	0900742.2
1400829.4M003		1400852.2
1400829.4M004	<b>06-05-2019</b>	1400853.4M001
1400829.4M005	0410974.0	1400853.4M002
1400830.6	0410978.9	1400853.4M003
1400831.8M001	0410986.6M001	1400853.4M004
1400831.8M002	0410986.6M002	1400854.6
1400831.8M003	0410987.8M001	1400855.9
1400832.0M001	0410987.8M002	1400856.1
1400832.0M002	0410988.0M001	1400857.3
1400833.2	0410988.0M002	1400858.5M001
	0410988.0M003	1400858.5M002
	0410988.0M004	1400859.7M001
<b>03-05-2019</b>	0410988.0M005	1400859.7M002
0410935.9	0900732.1	1400861.1
0410936.1	1400842.1M001	1400862.3
0410938.5	1400842.1M002	1400863.5
0900704.2	1400842.1M003	
0900705.5	1400842.1M004	
	1400842.1M005	
<b>04-05-2019</b>	1400843.3M001	<b>08-05-2019</b>
0410955.1	1400843.3M002	1400864.7
0900710.5M003	1400844.5	1400865.0
0900710.5M004	1400845.8	1400866.2
0900710.5M005	1400846.0	1400867.4M001
0900711.7	1400848.4M001	1400867.4M002
0900716.8	1400848.4M002	1400867.4M003
0900717.0	1400848.4M003	1400868.6
0900718.2	1400848.4M004	1400869.8
0900719.4M001	1400848.4M005	1400870.0
0900719.4M002	1400848.4M006	1400871.2
0900721.8M002	1400848.4M008	1400872.4M001
1400834.4M001		1400872.4M002
		1400873.6
		1400874.8

**09-05-2019**

0411011.0

0411013.4M001



香港特別行政區政府知識產權署外觀設計註冊處

The Government of the Hong Kong Special Administrative Region

Designs Registry, Intellectual Property Department

**根據註冊外觀設計規則第 31 條刪除的註冊外觀設計。各組記項按註冊外觀設計 刪除日期及註冊編號先後次序排列。**

**Registered designs removed under section 31 of the Registered Designs Rules. Entries are listed below under their removal dates.**

**01-05-2019 - 09-05-2019****02-05-2019**

0802552.0	1301880.1	1301932.2M003
0802560.7	1301881.3	1301932.2M004
0802562.1	1301883.7	1301932.2M005
0802563.3	1301892.6M001	1301932.2M006
0802571.0	1301892.6M002	1301932.2M007
0802573.4	1301894.0	1301932.2M008
0802575.9M004	1301897.7	1301932.2M009
0802575.9M006	1301898.9	1301932.2M010
0802580.9	1301900.5M001	1301932.2M011
0802590.0	1301900.5M002	1301932.2M012
0802592.4M001	1301901.7M001	1301932.2M013
0802592.4M002	1301901.7M002	1301932.2M014
0802592.4M003	1301901.7M003	1301933.4M002
0802593.6	1301902.9	1301935.9
1301795.1	1301903.1	1301936.1
1301830.6	1301904.3M001	1301937.3
1301853.4	1301904.3M002	1301943.5
1301854.6	1301904.3M003	1301944.7M001
1301855.9M001	1301905.6M001	1301944.7M002
1301855.9M002	1301905.6M002	1301944.7M003
1301856.1	1301905.6M003	1301945.0
1301857.3	1301911.8M001	1301946.2M001
1301858.5	1301911.8M002	1301946.2M002
1301859.7M001	9811377.8	1301949.8

**06-05-2019**

0311826.8

**07-05-2019**

1301860.9	0311826.8	<b>08-05-2019</b>
1301861.1		1301950.0M004
1301862.3M001	<b>07-05-2019</b>	1301951.2
1301862.3M002	0311852.2M001	1301952.4M001
1301862.3M003	0311852.2M002	1301952.4M002
1301862.3M004	0311853.4	1301952.4M003
1301862.3M005	0802603.9M001	1301952.4M004
1301862.3M006	0802603.9M002	1301952.4M005
1301862.3M007	0802607.8M001	1301952.4M006
1301866.2M001	0802607.8M002	1301952.4M007
1301866.2M002	0802607.8M003	1301952.4M008
1301867.4M001	0802607.8M004	1301952.4M009
1301867.4M002	0802607.8M006	1301952.4M010
1301868.6	0802614.2M001	1301952.4M011
1301870.0	0802614.2M002	1301952.4M012
1301871.2	1301915.7	1301953.6
1301872.4	1301916.9	1301954.8
1301873.6	1301917.1	1301955.1
1301874.8	1301918.3	
1301875.1	1301919.5	
1301876.3	1301922.1M001	
1301877.5	1301932.2M001	
1301878.7	1301932.2M002	