

香港知識產權公報

Hong Kong Intellectual Property Journal

2020年7月24日

24 July 2020

目錄 Contents

根據註冊外觀設計條例第 25 條註冊的外觀設計

Designs Registered under section 25 of the Registered Designs Ordinance

按註冊編號排列

Arranged by Registration Number

根據註冊外觀設計條例(第 522 章)公布的其他公告

Other Notices Published under the Registered Designs Ordinance (Cap. 522)

根據註冊外觀設計條例第 28 條，註冊外觀設計因未繳續期費而停止有效

Registered designs ceased through non-payment of renewal fees under section 28 of the Registered Designs Ordinance

根據註冊外觀設計規則第 31 條刪除的註冊外觀設計

Registered designs removed under section 31 of the Registered Designs Rules

勘誤

Corrigendum

以下事項沒有記錄

No Records for the Following Matters

根據註冊外觀設計條例第 30 條放棄的外觀設計的註冊

Surrender of Registration of Design under section 30 of the Registered Designs Ordinance

根據註冊外觀設計規則第 37 條，向處長作出轉介

Reference to Registrar under section 37 of the Registered Designs Rules

根據註冊外觀設計條例第 45 條，撤銷註冊

Revocation of Registration under section 45 of the Registered Designs Ordinance

根據註冊外觀設計規則第 46 條，向法院作出轉介

Reference to Court under section 46 of the Registered Designs Rules

根據註冊外觀設計規則第 63 條對不符合規定之處作出糾正

Rectification of Irregularities under section 63 of the Registered Designs Rules

根據註冊外觀設計條例第 66 條，糾正註冊紀錄冊

Rectification of Register under section 66 of the Registered Designs Ordinance

根據註冊外觀設計條例第 67 條 更正註冊紀錄冊內的錯誤

Correction of errors in Register under section 67 of the Registered Designs Ordinance

根據註冊外觀設計條例第 67 及 76 條，更正註冊紀錄冊內及已提交文件中的錯誤

Correction of Errors in Register and in Filed Documents under sections 67 and 76 of the Registered Designs Ordinance

根據註冊外觀設計條例第 76 條，更正已提交文件中的錯誤

Correction of errors in filed documents under section 76 of the Registered Designs Ordinance

註冊外觀設計公告註釋

Notes on advertisements of registration of designs

方括號表示下列資料：

Square brackets indicate the following data：

[11] 註冊編號 Registration number / 聯合王國註冊編號 United Kingdom registration number

[15] 註冊日期 Registration date / 當作註冊日期 Deemed registration date / 聯合王國註冊日期 United Kingdom registration date

[17] 註冊有效期屆滿日期 Expiry date of the period of registration

[22] 提交日期 Filing date / 當作提交日期 Deemed filing date / 聯合王國提交日期 United Kingdom filing date

[30] 聲稱享有的優先權（提交日期 / 巴黎公約國或世界貿易組織成員 / 申請編號） Priority claimed (filing date / Paris Convention country or WTO member / application number)

[51] 國際外觀設計分類號（洛迦諾分類號） International Classification of designs (Locarno Classification)

[54] 物品 Article

[55] 外觀設計的表述 Representation of the design

[62] 分開前的申請編號及提交日期 Application number before division and filing date

[66] 過往註冊的聯繫外觀設計註冊編號 / 日期 Registration No. / Date of Previous Registration for Association

[72] 設計人 Designer

[73] 擁有人姓名和地址 Name and address of the owner

[74] 代理人 Agent / 送達地址 Address for service



香港特別行政區政府知識產權署外觀設計註冊處

The Government of the Hong Kong Special Administrative Region

Designs Registry, Intellectual Property Department

根據註冊外觀設計條例第 25 條註冊的外觀設計

Designs registered under section 25 of the Registered Designs Ordinance

按註冊編號排列

Arranged by Registration Number

- [11] 1915031.3
- [15] 18-11-2019
- [30] 23-08-2019 / US / 29/703,109
- [51] Cl. 11-01
- [54] 經配置的珠寶鑽石
Jewelry diamond arrangement
- [73] 榮義珠寶玉石有限公司
Wing Yee Gems & Jewellery
香港
九龍紅磡崇平街 2 號富德中心
7 樓 701-702 室
- [74] 智雅知識產權代理公司
香港
荃灣青山道 264-298 號
南豐中心 1905 室

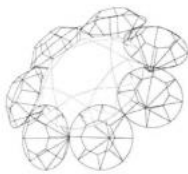

-
- [11] 1915221.6M001
 - [15] 10-12-2019
 - [51] Cl. 2-01
Cl. 2-02
Cl. 2-03

Cl. 2-04

Cl. 2-07

[54] 用於廣告宣傳、展示及兒童服飾產品的吉祥物

Mascot for promotion, advertisement and kids wear products

[73] Citistore (Hong Kong) Limited

香港新界

荃灣眾安街 68 號

千色匯 9 樓

[74] Citistore (Hong Kong) Limited

香港新界

荃灣眾安街 68 號

千色匯 9 樓



[11] 1915221.6M002

[15] 10-12-2019

[51] Cl. 2-01

Cl. 2-02

Cl. 2-03

Cl. 2-04

Cl. 2-07

[54] 用於廣告宣傳、展示及兒童服飾產品的吉祥物

Mascot for promotion, advertisement and kids wear products

[73] Citistore (Hong Kong) Limited

香港新界

荃灣眾安街 68 號

千色匯 9 樓

[74] Citistore (Hong Kong) Limited

香港新界

荃灣眾安街 68 號

千色匯 9 樓



[11] 1915221.6M003

[15] 10-12-2019

[51] Cl. 2-01

Cl. 2-02

Cl. 2-03

Cl. 2-04

Cl. 2-07

[54] 用於廣告宣傳、展示及兒童服飾產品的吉祥物

Mascot for promotion, advertisement and kids wear products

[73] Citistore (Hong Kong) Limited

香港新界

荃灣眾安街 68 號

千色匯 9 樓

[74] Citistore (Hong Kong) Limited

香港新界

荃灣眾安街 68 號

千色匯 9 樓

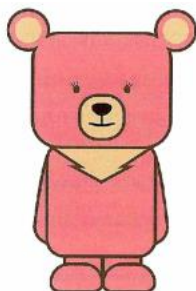

[11] 1915287.5

[15] 20-12-2019

[51] Cl. 9-03

[54] 智能手機透明紋理保護殼

Transparent textured case for smartphone

[73] Design Pool Limited

2/F, Eastown Building,

41 Lockhart Road,
Hong Kong

[74] Design Pool Limited
2/F, Eastown Building,
41 Lockhart Road,
Hong Kong

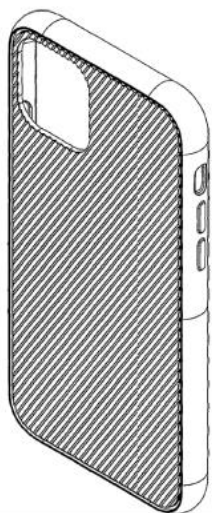

[11] 2015483.3M001

[15] 23-01-2020

[30] 23-08-2019 / CH / 144851

[51] Cl. 12-05

[54] 電梯轎廂操作面板
Elevator car operating panel

[73] 因溫特奧股份公司
INVENTIO AG
Seestrasse 55, CH-6052,
Hergiswil NW,
Switzerland

[74] MARKS & CLERK
Level 9, Cyberport 1,
100 Cyberport Road, Pok Fu Lam,
Hong Kong



[11] 2015483.3M002

[15] 23-01-2020

[30] 23-08-2019 / CH / 144851

[51] Cl. 12-05

[54] 電梯轎廂操作面板

Elevator car operating panel

[73] 因溫特奧股份公司

INVENTIO AG

Seestrasse 55, CH-6052,

Hergiswil NW,

Switzerland

[74] MARKS & CLERK

Level 9, Cyberport 1,

100 Cyberport Road, Pok Fu Lam,

Hong Kong



- [11] 2015485.8M001
[15] 23-01-2020
[30] 23-08-2019 / CH / 144853
[51] Cl. 12-05
[54] 電梯用操作和顯示面板
Operating and display panel for elevator
[73] 因溫特奧股份公司
INVENTIO AG
Seestrassen 55, CH-6052,
Hergiswil NW,
Switzerland
[74] MARKS & CLERK
Level 9, Cyberport 1,
100 Cyberport Road,
Pok Fu Lam, Hong Kong



-
- [11] 2015485.8M002
[15] 23-01-2020
[30] 23-08-2019 / CH / 144853
[51] Cl. 12-05
[54] 電梯用操作和顯示面板
Operating and display panel for elevator
[73] 因溫特奧股份公司
INVENTIO AG
Seestrassen 55, CH-6052,
Hergiswil NW,
Switzerland
[74] MARKS & CLERK
Level 9, Cyberport 1,

100 Cyberport Road,
Pok Fu Lam, Hong Kong



-
- [11] 2015485.8M003
 - [15] 23-01-2020
 - [30] 23-08-2019 / CH / 144853
 - [51] Cl. 12-05
 - [54] 電梯用操作和顯示面板
Operating and display panel for elevator
 - [73] 因溫特奧股份公司
INVENTIO AG
Seestrasse 55, CH-6052,
Hergiswil NW,
Switzerland
 - [74] MARKS & CLERK
Level 9, Cyberport 1,
100 Cyberport Road,
Pok Fu Lam, Hong Kong



[11] 2015487.2

[15] 23-01-2020

[30] 23-08-2019 / CH / 144851

[51] Cl. 12-05

[54] 電梯轎廂操作面板的動態圖形用戶界面

Graphical user interfaces of an elevator car operating panel

[73] 因溫特奧股份公司

INVENTIO AG

Seestrasse 55, CH-6052,

Hergiswil NW,

Switzerland

[74] MARKS & CLERK

Level 9, Cyberport 1

100 Cyberport Road,

Pok Fu Lam, Hong Kong



- [11] 2015668.7
[15] 26-02-2020
[51] Cl. 9-03
[54] 可折疊容器
Foldable container
[73] Plastmetic (Hong Kong) Manufactory Limited
Unit 12, 18/F., Rear Block,
Wah Fat Industrial Building,
10-14 Kung Yip Street, Kwai Chung,
New Territories, Hong Kong
[74] CHAN, TANG & KWOK
Rooms 2503-04, 25/F.,
Shanghai Industrial Investment Building,
48-62 Hennessy Road,
Wanchai, Hong Kong

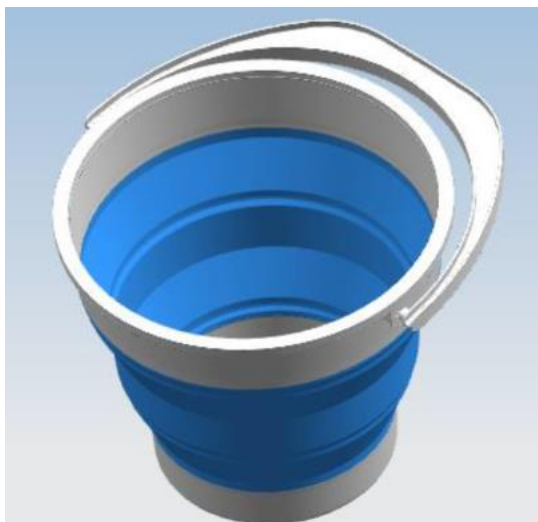

-
- [11] 2015669.9M001
[15] 27-02-2020
[30] 02-09-2019 / EU / 006809141
[51] Cl. 28-03
[54] 梳粧用品和美容院設備的圖形設計
Graphical design for toilet articles and beauty parlor
equipment
[73] Koninklijke Philips N.V.
High Tech Campus 52,
5656 AG Eindhoven,
NETHERLANDS
[74] WILKINSON & GRIST
6th Floor, Prince's Building,

Chater Road,
Hong Kong



[11] 2015669.9M002

[15] 27-02-2020

[30] 02-09-2019 / EU / 006809141

[51] Cl. 28-03

[54] 梳粧用品和美容院設備的圖形設計

Graphical design for toilet articles and beauty parlor
equipment

[73] Koninklijke Philips N.V.

High Tech Campus 52,
5656 AG Eindhoven,
NETHERLANDS

[74] WILKINSON & GRIST

6th Floor, Prince's Building,
Chater Road,
Hong Kong



[11] 2015669.9M003

[15] 27-02-2020

[30] 02-09-2019 / EU / 006809141

[51] Cl. 28-03

[54] 梳粧用品和美容院設備的圖形設計

Graphical design for toilet articles and beauty parlor
equipment

[73] Koninklijke Philips N.V.

High Tech Campus 52,

5656 AG Eindhoven,

NETHERLANDS

[74] WILKINSON & GRIST

6th Floor, Prince's Building,

Chater Road,

Hong Kong



[11] 2015669.9M004

[15] 27-02-2020

[30] 02-09-2019 / EU / 006809141

[51] Cl. 28-03

[54] 梳粧用品和美容院設備的圖形設計

Graphical design for toilet articles and beauty parlor
equipment

[73] Koninklijke Philips N.V.

High Tech Campus 52,

5656 AG Eindhoven,

NETHERLANDS

[74] WILKINSON & GRIST

6th Floor, Prince's Building,

Chater Road,
Hong Kong



[11] 2015669.9M005

[15] 27-02-2020

[30] 02-09-2019 / EU / 006810115

[51] Cl. 28-03

[54] 梳粧用品和美容院設備的圖形設計

Graphical design for toilet articles and beauty parlor
equipment

[73] Koninklijke Philips N.V.

High Tech Campus 52,
5656 AG Eindhoven,
NETHERLANDS

[74] WILKINSON & GRIST

6th Floor, Prince's Building,
Chater Road,
Hong Kong



[11] 2015670.1M001

[15] 27-02-2020

[30] 10-09-2019 / EU / 006852711

[51] Cl. 7-02

[54] 攪拌器

Blender

[73] Koninklijke Philips N.V.

High Tech Campus 52,

5656 AG Eindhoven,

NETHERLANDS

[74] WILKINSON & GRIST

6th Floor, Prince's Building,

Chater Road,

Hong Kong

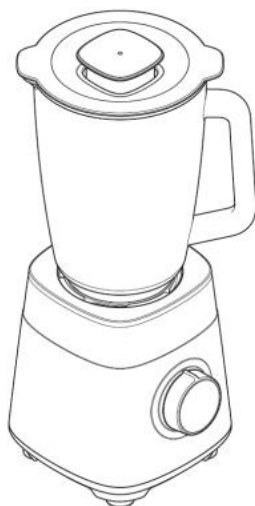

[11] 2015670.1M002

[15] 27-02-2020

[30] 10-09-2019 / EU / 006852711

[51] Cl. 7-02

[54] 攪拌器

Blender

[73] Koninklijke Philips N.V.

High Tech Campus 52,

5656 AG Eindhoven,

NETHERLANDS

[74] WILKINSON & GRIST

6th Floor, Prince's Building,

Chater Road,

Hong Kong

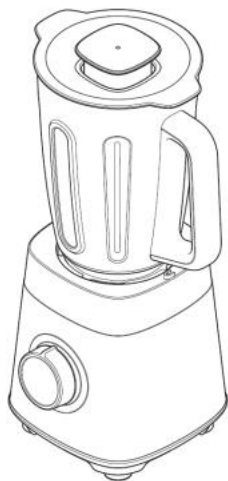

[11] 2015670.1M003

[15] 27-02-2020

[30] 10-09-2019 / EU / 006852711

[51] Cl. 7-02

[54] 攪拌器
Blender

[73] Koninklijke Philips N.V.
High Tech Campus 52,
5656 AG Eindhoven,
NETHERLANDS

[74] WILKINSON & GRIST
6th Floor, Prince's Building,
Chater Road,
Hong Kong

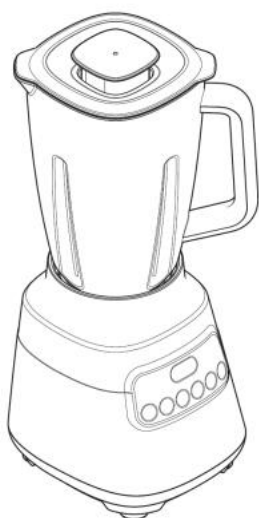

[11] 2015671.3

[15] 27-02-2020

[51] Cl. 23-04

[54] 香薰機

Aroma diffuser

[73] 盛開蓮花有限公司

Bloomy Lotus Ltd

Unit 4711, 47/F., The Center,

99 Queen's Road Central,

Central, Hong Kong

[74] FEDERATION OF HONG KONG INDUSTRIES

31/F, Billion Plaza,

8 Cheung Yue Street,

Cheung Sha Wan, Kowloon

Hong Kong

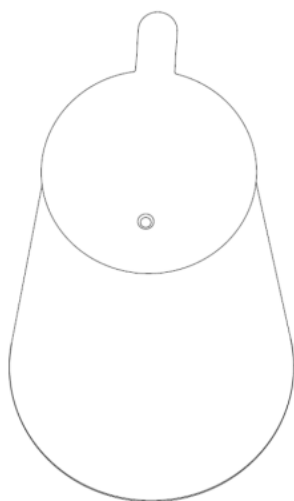

[11] 2015672.5

[15] 27-02-2020

[51] Cl. 10-07

[54] 錶面

Watch dial

[73] 西鐵城時計株式會社

CITIZEN WATCH CO., LTD.

1-12, Tanashicho 6-chome,

Nishitokyo-shi,

Tokyo 188-8511,

JAPAN

[74] WILKINSON & GRIST

6th Floor, Prince's Building,

Chater Road,

Hong Kong

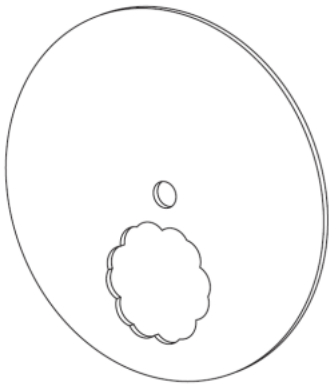

[11] 2015673.7M001

[15] 18-07-2019

[51] Cl. 14-04

[54] 用於電腦的圖形用戶界面
Graphic user interface for computer

[73] AIS INNOVATION HOLDINGS LIMITED
Suite 3503, 35/F, Office Tower,
Convention Plaza,
1 Harbour Road,
Wanchai, Hong Kong

[74] WILKINSON & GRIST
6th Floor, Prince's Building,
Chater Road,
Hong Kong

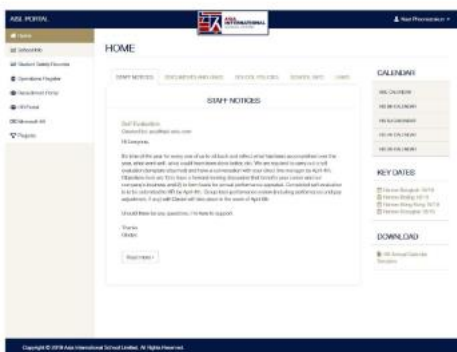

[11] 2015673.7M002

[15] 28-02-2020

[51] Cl. 14-04

[54] 用於電腦的圖形用戶界面
Graphic user interface for computer

[73] AIS INNOVATION HOLDINGS LIMITED
Suite 3503, 35/F, Office Tower,
Convention Plaza,
1 Harbour Road,
Wanchai, Hong Kong

[74] WILKINSON & GRIST
6th Floor, Prince's Building,
Chater Road,
Hong Kong

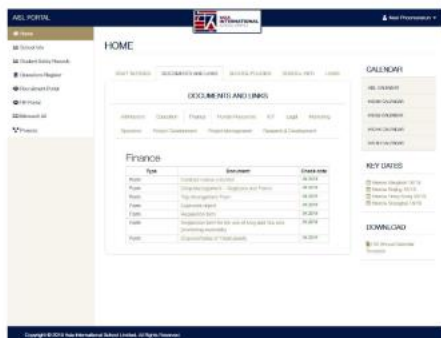

[11] 2015673.7M003

[15] 18-07-2019

[51] Cl. 14-04

[54] 用於電腦的圖形用戶界面
Graphic user interface for computer

[73] AIS INNOVATION HOLDINGS LIMITED
Suite 3503, 35/F, Office Tower,
Convention Plaza,
1 Harbour Road,
Wanchai, Hong Kong

[74] WILKINSON & GRIST
6th Floor, Prince's Building,
Chater Road,
Hong Kong

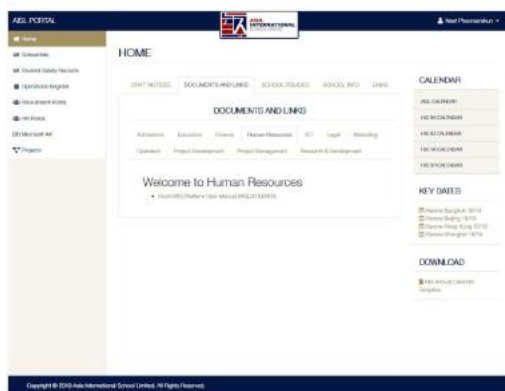



[11] 2015673.7M006

[15] 18-07-2019

[51] Cl. 14-04

[54] 用於電腦的圖形用戶界面
Graphic user interface for computer

[73] AIS INNOVATION HOLDINGS LIMITED
Suite 3503, 35/F, Office Tower,
Convention Plaza,
1 Harbour Road,
Wanchai, Hong Kong

[74] WILKINSON & GRIST
6th Floor, Prince's Building,
Chater Road,
Hong Kong

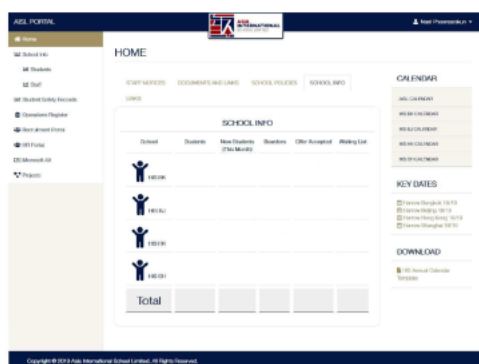

[11] 2015673.7M007

[15] 18-07-2019

[51] Cl. 14-04

[54] 用於電腦的圖形用戶界面
Graphic user interface for computer

[73] AIS INNOVATION HOLDINGS LIMITED
 Suite 3503, 35/F, Office Tower,
 Convention Plaza,
 1 Harbour Road,
 Wanchai, Hong Kong

[74] WILKINSON & GRIST
 6th Floor, Prince's Building,
 Chater Road,
 Hong Kong



[11] 2015673.7M008

[15] 18-07-2019

[51] Cl. 14-04

[54] 用於電腦的圖形用戶界面
 Graphic user interface for computer

[73] AIS INNOVATION HOLDINGS LIMITED
 Suite 3503, 35/F, Office Tower,
 Convention Plaza,
 1 Harbour Road,
 Wanchai, Hong Kong

[74] WILKINSON & GRIST
 6th Floor, Prince's Building,
 Chater Road,
 Hong Kong



-
- [11] 2015673.7M009
- [15] 18-07-2019
- [51] Cl. 14-04
- [54] 用於電腦的圖形用戶界面
Graphic user interface for computer
- [73] AIS INNOVATION HOLDINGS LIMITED
Suite 3503, 35/F, Office Tower,
Convention Plaza,
1 Harbour Road,
Wanchai, Hong Kong
- [74] WILKINSON & GRIST
6th Floor, Prince's Building,
Chater Road,
Hong Kong

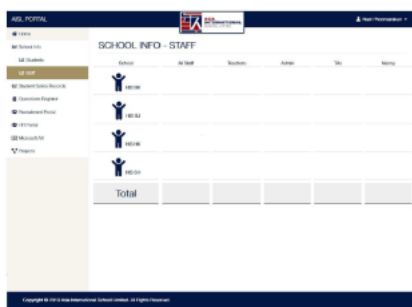

-
- [11] 2015673.7M010
- [15] 18-07-2019
- [51] Cl. 14-04
- [54] 用於電腦的圖形用戶界面
Graphic user interface for computer
- [73] AIS INNOVATION HOLDINGS LIMITED
Suite 3503, 35/F, Office Tower,
Convention Plaza,
1 Harbour Road,
Wanchai, Hong Kong
- [74] WILKINSON & GRIST
6th Floor, Prince's Building,
Chater Road,
Hong Kong

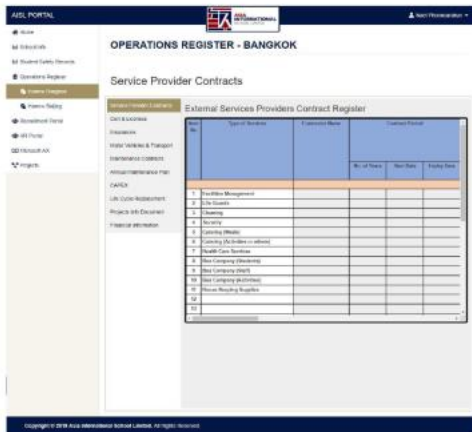

- [11] 2015673.7M011
- [15] 18-07-2019
- [51] Cl. 14-04
- [54] 用於電腦的圖形用戶界面
Graphic user interface for computer
- [73] AIS INNOVATION HOLDINGS LIMITED
Suite 3503, 35/F, Office Tower,
Convention Plaza,
1 Harbour Road,
Wanchai, Hong Kong
- [74] WILKINSON & GRIST
6th Floor, Prince's Building,
Chater Road,
Hong Kong

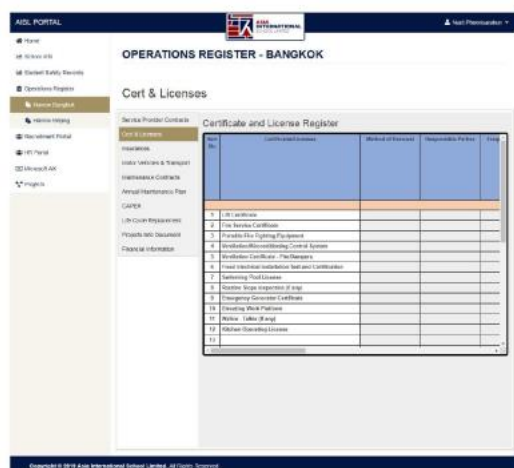

- [11] 2015673.7M012

[15] 18-07-2019

[51] Cl. 14-04

[54] 用於電腦的圖形用戶界面

Graphic user interface for computer

[73] AIS INNOVATION HOLDINGS LIMITED

Suite 3503, 35/F, Office Tower,

Convention Plaza,

1 Harbour Road,

Wanchai, Hong Kong

[74] WILKINSON & GRIST

6th Floor, Prince's Building,

Chater Road,

Hong Kong

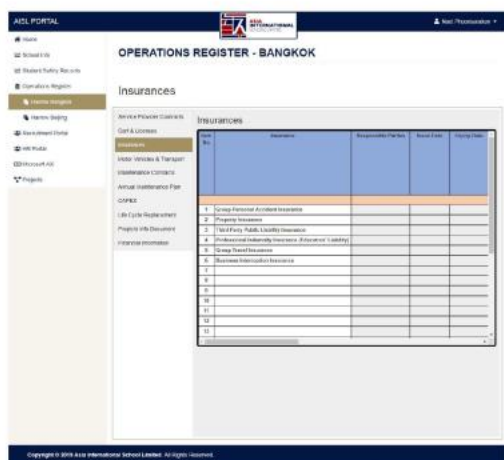

[11] 2015673.7M013

[15] 18-07-2019

[51] Cl. 14-04

[54] 用於電腦的圖形用戶界面

Graphic user interface for computer

[73] AIS INNOVATION HOLDINGS LIMITED

Suite 3503, 35/F, Office Tower,

Convention Plaza,

1 Harbour Road,

Wanchai, Hong Kong

[74] WILKINSON & GRIST

6th Floor, Prince's Building,

Chater Road,

Hong Kong

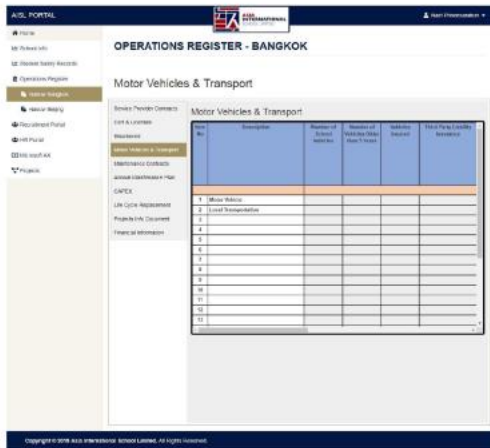

- [11] 2015673.7M014
- [15] 18-07-2019
- [51] Cl. 14-04
- [54] 用於電腦的圖形用戶界面
Graphic user interface for computer
- [73] AIS INNOVATION HOLDINGS LIMITED
Suite 3503, 35/F, Office Tower,
Convention Plaza,
1 Harbour Road,
Wanchai, Hong Kong
- [74] WILKINSON & GRIST
6th Floor, Prince's Building,
Chater Road,
Hong Kong

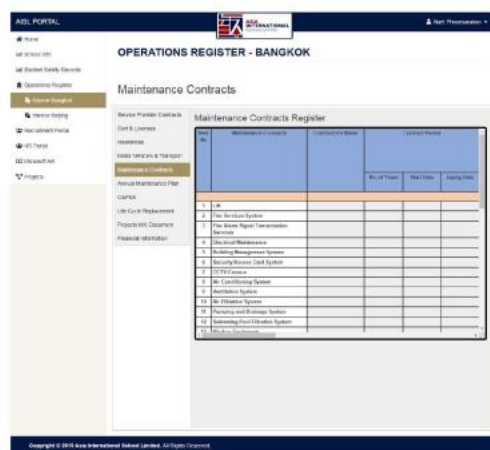

- [11] 2015673.7M015

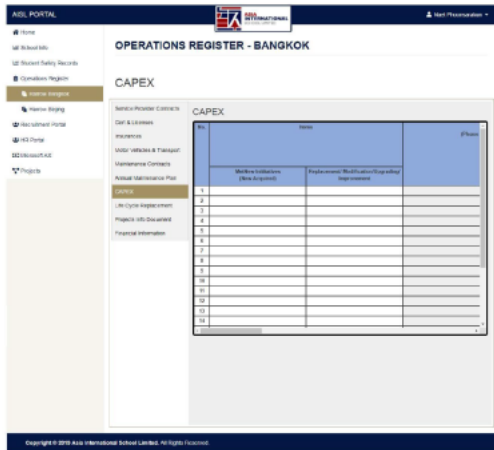

[11] 2015673.7M017

[15] 18-07-2019

[51] Cl. 14-04

[54] 用於電腦的圖形用戶界面
Graphic user interface for computer

[73] AIS INNOVATION HOLDINGS LIMITED
Suite 3503, 35/F, Office Tower,
Convention Plaza,
1 Harbour Road,
Wanchai, Hong Kong

[74] WILKINSON & GRIST
6th Floor, Prince's Building,
Chater Road,
Hong Kong



[11] 2015673.7M018

- [15] 18-07-2019
- [51] Cl. 14-04
- [54] 用於電腦的圖形用戶界面
Graphic user interface for computer
- [73] AIS INNOVATION HOLDINGS LIMITED
Suite 3503, 35/F, Office Tower,
Convention Plaza,
1 Harbour Road,
Wanchai, Hong Kong
- [74] WILKINSON & GRIST
6th Floor, Prince's Building,
Chater Road,
Hong Kong

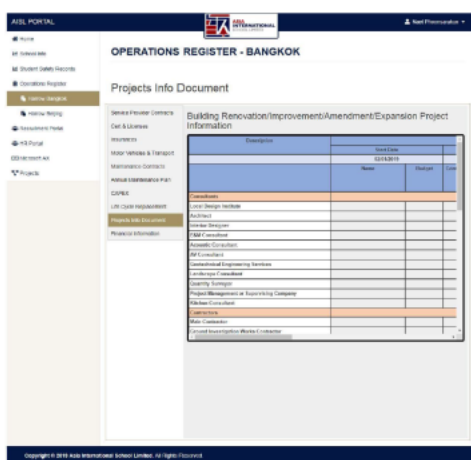

- [11] 2015673.7M019
- [15] 18-07-2019
- [51] Cl. 14-04
- [54] 用於電腦的圖形用戶界面
Graphic user interface for computer
- [73] AIS INNOVATION HOLDINGS LIMITED
Suite 3503, 35/F, Office Tower,
Convention Plaza,
1 Harbour Road,
Wanchai, Hong Kong
- [74] WILKINSON & GRIST
6th Floor, Prince's Building,
Chater Road,
Hong Kong

The screenshot shows a web-based financial information system. The main content area is titled "BUDGET AND FORECAST" and contains a table with columns for "Budget Item", "Budget Amount", and "Forecast Amount". The table lists various items such as "Salaries", "Travel", "Printing", and "Maintenance". The interface includes a sidebar with navigation options like "Home", "Reports", and "Settings".

- [11] 2015674.9
- [15] 28-02-2020
- [30] 14-01-2020 / CN / 202030023158.7
- [51] Cl. 13-02
- [54] 移動電源
Mobile power supply
- [73] 廣東高普達集團股份有限公司
GUANGDONG GOPOD GROUP CO., LTD
中國內地
深圳市龍華新區大浪街道同勝社區華榮路
聯建科技工業園廠房 8 棟 4, 5, 6 樓
- [74] 中一聯合國際知識產權有限公司
香港九龍尖沙咀
漆咸道南 45-51 號
其士大廈 803 室



- [11] 2015675.2

- [15] 28-02-2020
- [30] 19-09-2019 / EU / 006887170-0001
- [51] Cl. 28-03
- [54] 電髮器的配件
Accessory for hair straightener
- [73] Dyson Technology Limited
Tetbury Hill, Malmesbury,
Wiltshire, SN16 0RP,
UNITED KINGDOM
- [74] LIU, SHEN & ASSOCIATES
Room 3716, 37/F, Sun Hung Kai Centre,
30 Harbour Road,
Wanchai, Hong Kong

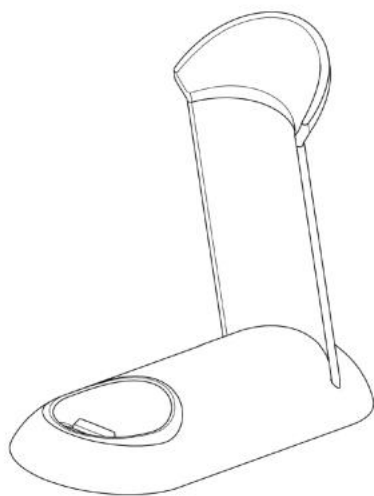

-
- [11] 2015676.4M001
- [15] 28-02-2020
- [30] 29-08-2019 / US / 29/703,858
- [51] Cl. 14-03
- [54] 通訊用耳塞式耳機
Communication earbud
- [73] 續特力股份有限公司
PLANTRONICS, INC.
345 Encinal St.,
Santa Cruz, CA 95060,
UNITED STATES
- [74] SHANGHAI INTELLECTUAL PROPERTY OFFICE
Unit F, 20th Floor, Neich Tower,
128 Gloucester Road,
Hong Kong

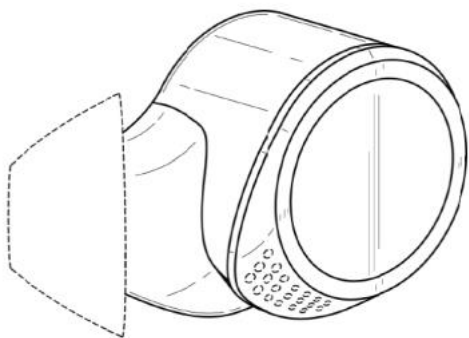

[11] 2015676.4M002

[15] 28-02-2020

[30] 29-08-2019 / US / 29/703,858

[51] Cl. 14-03

[54] 通訊用耳塞式耳機

Communication earbud

[73] 續特力股份有限公司

PLANTRONICS, INC.

345 Encinal St.,

Santa Cruz, CA 95060,

UNITED STATES

[74] SHANGHAI INTELLECTUAL PROPERTY OFFICE

Unit F, 20th Floor, Neich Tower,

128 Gloucester Road,

Hong Kong

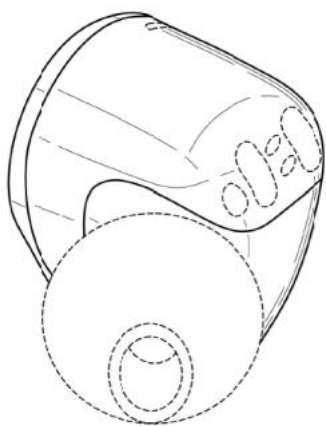

[11] 2015678.8

[15] 02-03-2020

[51] Cl. 29-02

[54] 矽膠呼吸口罩配合過濾芯

Silicone rubber respiratory mask with filter

[73] 王紀棠

WONG KEI TONG MORRIS

G/F, 60C Nam Wai Village,

Sai Kung,

Hong Kong

[74] WONG KEI TONG MORRIS

G/F, 60C Nam Wai Village,

Sai Kung,

Hong Kong

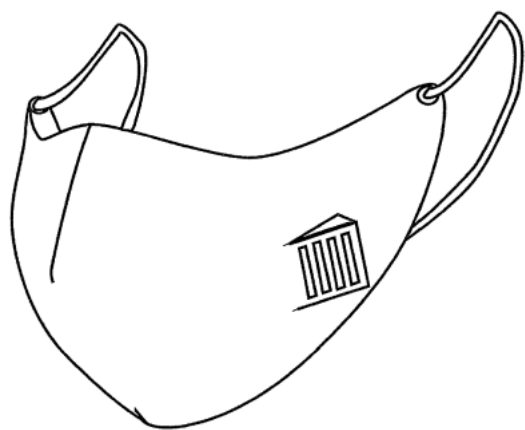

[11] 2015679.0

[15] 02-03-2020

[30] 24-09-2019 / CN / 201930525013.4

[51] Cl. 13-02

[54] 充電底座

Charging base

[73] 北京小米移動軟件有限公司

BEIJING XIAOMI MOBILE SOFTWARE CO., LTD.

中國內地

北京市海澱區西二旗中路

33 號院 6 號樓 8 層 018 號

[74] 香港派特恩知識產權代理有限公司

香港上環

永樂街 121-125 號

永達商業大廈 10 樓 C 室

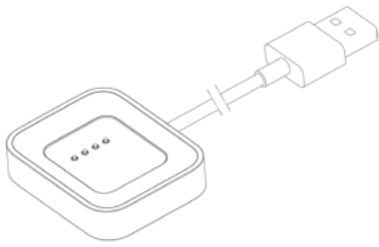

[11] 2015682.6

[15] 02-03-2020

[51] Cl. 7-02

[54] 鍋
Pot

[73] 羽田市場株式會社
Haneda Ichiba Co.,Ltd.
3-2-6
Haneda-kuko, Ota-ku, Tokyo,
JAPAN

[74] Bird & Bird
6/F, The Annex, Central Plaza
18 Harbour Road
Hong Kong



[11] 2015683.8

[15] 03-03-2020

[51] Cl. 24-02
Cl. 24-01

[54] 健康護理裝置
Healthcare device

[73] 倍靈科技有限公司
Belun Technology Company Limited
Unit 218, Floor 2, Core Building 2,

No. 1 Science Park West Avenue,
Hong Kong Science Park,
Shatin, New Territories, Hong Kong

- [74] Belun Technology Company Limited
Unit 218, Floor 2, Core Building 2,
No. 1 Science Park West Avenue,
Hong Kong Science Park,
Shatin, New Territories, Hong Kong

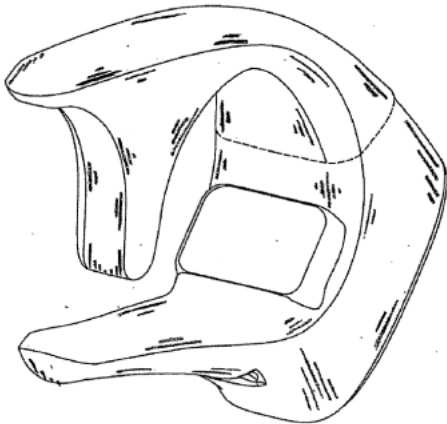

[11] 2015685.3

[15] 03-03-2020

[51] Cl. 28-03

[54] 多功能眼睛按摩儀

Multi function eyes massager

[73] 美斯凱實業有限公司

Maxcare Industrial Limited

香港北角

健康東街 39 號

柯達大廈 II 期 1601 室

[74] Karen Hung (Maxcare Ind. Ltd.)

香港北角

健康東街 39 號

柯達大廈 II 期 1601 室



[11] 2015686.5

[15] 03-03-2020

[30] 04-09-2019 / US / 29/704,407

[51] Cl. 14-01

[54] 耳塞式耳機

Earbud headset

[73] Skullcandy, Inc.

6301 N. Landmark Dr.

Park City, UT 84098,

UNITED STATES

[74] CLT PATENT & TRADEMARK (H.K.) LIMITED

Unit 09, 34/F., Office Tower, Convention Plaza,

No. 1 Harbour Road,

Wanchai, Hong Kong

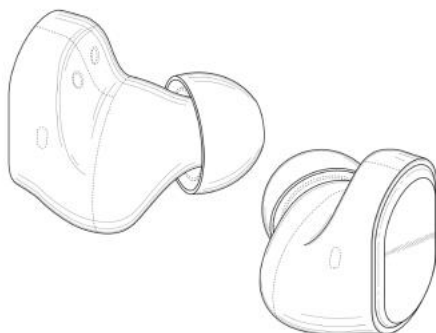

[11] 2015687.7

[15] 03-03-2020

[51] Cl. 7-05

[54] 燙斗

Garment steamer

[73] 廣東天物新材料科技有限公司

Guangdong Flexwarm Advanced Materials & Technology Co., Ltd.

中國內地

廣州市番禺區沙灣鎮

紫坭村西安路 7 號 (辦公大樓)

[74] 香港專利商標代理有限公司

香港

皇后大道西 419K

博仕臺 10 樓 A 室



[11] 2015688.9

[15] 04-03-2020

[30] 23-12-2019 / EU / 007448071

[51] Cl. 2-02

Cl. 2-07

Cl. 2-05

Cl. 2-04

Cl. 2-03

[54] 用於服裝，帽子，鞋子，圍巾和皮帶的裝飾

Ornamentation for garments, caps, shoes, scarves and belts

[73] Fendi S.r.l.

Palazzo della Civiltà Italiana,

Quadrato della Concordia 3,

00144 Roma,

ITALY

[74] WOO KWAN LEE & LO

Room 2801, Sun Hung Kai Centre,

30 Harbour Road,

Wanchai, Hong Kong



[11] 2015689.1

[15] 04-03-2020

[30] 06-09-2019 / DE / 402019100959.0

[51] Cl. 21-01

[54] 玩具車

Toy vehicle

[73] VOLKSWAGEN AKTIENGESELLSCHAFT

BERLINER RING 2,

38440 WOLFSBURG,

GERMANY

[74] CHINA PATENT AGENT (HONG KONG) LIMITED

22/F, Great Eagle Centre,

23 Harbour Road,

Wanchai, Hong Kong



[11] 2015690.3M001

[15] 05-03-2020

[30] 06-09-2019 / DE / 402019100960.4

[51] Cl. 12-08

[54] 汽車

Motor vehicle

[73] VOLKSWAGEN AKTIENGESELLSCHAFT

BERLINER RING 2,
38440 WOLFSBURG,
GERMANY

[74] CHINA PATENT AGENT (HONG KONG) LIMITED

22/F, Great Eagle Centre,
23 Harbour Road,
Wanchai, Hong Kong



[11] 2015690.3M002

[15] 05-03-2020

[30] 06-09-2019 / DE / 402019100960.4

[51] Cl. 12-08

[54] 汽車

Motor vehicle

[73] VOLKSWAGEN AKTIENGESELLSCHAFT

BERLINER RING 2,
38440 WOLFSBURG,
GERMANY

[74] CHINA PATENT AGENT (HONG KONG) LIMITED

22/F, Great Eagle Centre,
23 Harbour Road,
Wanchai, Hong Kong



[11] 2015690.3M003

- [15] 05-03-2020
[30] 06-09-2019 / DE / 402019100960.4
[51] Cl. 12-08
[54] 汽車
Motor vehicle
[73] VOLKSWAGEN AKTIENGESELLSCHAFT
BERLINER RING 2,
38440 WOLFSBURG,
GERMANY
[74] CHINA PATENT AGENT (HONG KONG) LIMITED
22/F, Great Eagle Centre,
23 Harbour Road,
Wanchai, Hong Kong



-
- [11] 2015691.5
[15] 05-03-2020
[30] 06-09-2019 / DE / 402019100960.4
[51] Cl. 21-01
[54] 玩具汽車
Toy vehicle
[73] VOLKSWAGEN AKTIENGESELLSCHAFT
BERLINER RING 2,
38440 WOLFSBURG,
GERMANY
[74] CHINA PATENT AGENT (HONG KONG) LIMITED
22/F, Great Eagle Centre,
23 Harbour Road,
Wanchai, Hong Kong



[11] 2015692.7M001

[15] 05-03-2020

[30] 16-12-2019 / NO, SG, CH, EU, JP / DM/205 375

[51] Cl. 7-02

[54] 煮咖啡器

Coffee maker

[73] Pi-Design AG

Kantonsstrasse 100,

CH-6234 Triengen,

SWITZERLAND

[74] WENPING PATENT & TRADE MARK AGENT LIMITED

1701 Tung Wai Commercial Building,

111 Gloucester Road,

Hong Kong

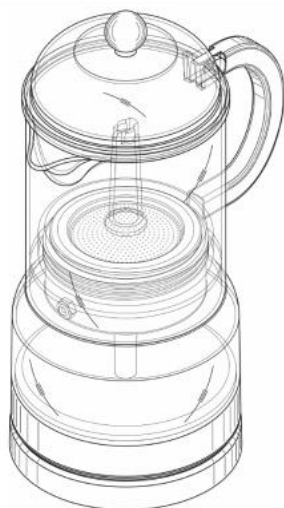

[11] 2015692.7M002

[15] 05-03-2020

[30] 16-12-2019 / NO, SG, CH, EU, JP / DM/205 375

[51] Cl. 7-02

[54] 煮咖啡器

Coffee maker

[73] Pi-Design AG

Kantonsstrasse 100,

CH-6234 Triengen,

SWITZERLAND

[74] WENPING PATENT & TRADE MARK AGENT LIMITED

1701 Tung Wai Commercial Building,

111 Gloucester Road,

Hong Kong

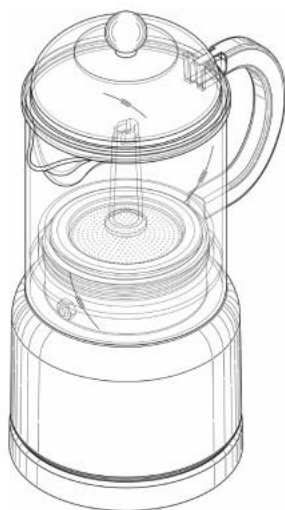

[11] 2015693.9

[15] 05-03-2020

[30] 17-09-2019 / JP / 020759 of 2019

[51] Cl. 28-03

[54] 按摩器

Massage equipment

[73] 株式會社布倫克蕾喜

BLOOM CLASSIC CO., LTD.

4-3-28, Akasaka, Minato-Ku,

Tokyo, 107-0052,

JAPAN

[74] FAIRBAIRN CATLEY LOW & KONG

23/F, Shui On Centre,

6-8 Harbour Road,

Wanchai, Hong Kong



[11] 2015694.1M001

[15] 05-03-2020

[51] Cl. 11-01

[54] 手鐲

Bangle

[73] Lovemark Diamond (HK) Limited

香港九龍

紅磡崇安街 18 號

半島廣場 14 樓 6 室

[74] Evita Chan

香港九龍尖沙咀

漆咸道南 45-51 號

其士大廈 6 樓 6 室



[11] 2015694.1M002

[15] 05-03-2020

[51] Cl. 11-01

[54] 手鐲

Bangle

[73] Lovemark Diamond (HK) Limited

香港九龍

紅磡崇安街 18 號

半島廣場 14 樓 6 室

[74] Evita Chan

香港九龍尖沙咀

漆咸道南 45-51 號
其士大廈 6 樓 6 室



-
- [11] 2015694.1M003
[15] 05-03-2020
[51] Cl. 11-01
[54] 手鐲
Bangle
[73] Lovemark Diamond (HK) Limited
香港九龍
紅磡崇安街 18 號
半島廣場 14 樓 6 室
[74] Evita Chan
香港九龍尖沙咀
漆咸道南 45-51 號
其士大廈 6 樓 6 室



-
- [11] 2015694.1M004
[15] 05-03-2020
[51] Cl. 11-01
[54] 手鐲
Bangle
[73] Lovemark Diamond (HK) Limited
香港九龍
紅磡崇安街 18 號
半島廣場 14 樓 6 室
[74] Evita Chan
香港九龍尖沙咀
漆咸道南 45-51 號
其士大廈 6 樓 6 室



-
- [11] 2015694.1M005
[15] 05-03-2020
[51] Cl. 11-01
[54] 耳環
Earrings
[73] Lovemark Diamond (HK) Limited
香港九龍
紅磡崇安街 18 號
半島廣場 14 樓 6 室
[74] Evita Chan
香港九龍尖沙咀
漆咸道南 45-51 號
其士大廈 6 樓 6 室

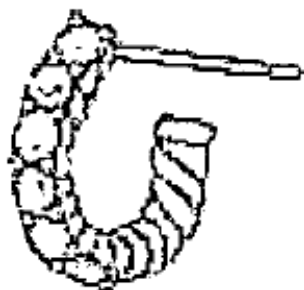

-
- [11] 2015694.1M006
[15] 05-03-2020
[51] Cl. 11-01
[54] 耳環
Earrings
[73] Lovemark Diamond (HK) Limited
香港九龍
紅磡崇安街 18 號
半島廣場 14 樓 6 室

[74] Evita Chan
香港九龍尖沙咀
漆咸道南 45-51 號
其士大廈 6 樓 6 室

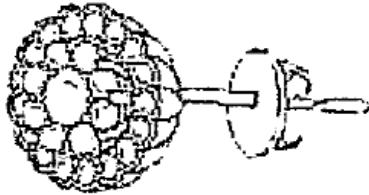

[11] 2015694.1M007

[15] 05-03-2020

[51] Cl. 11-01

[54] 耳環

Earrings

[73] Lovemark Diamond (HK) Limited

香港九龍

紅磡崇安街 18 號

半島廣場 14 樓 6 室

[74] Evita Chan

香港九龍尖沙咀

漆咸道南 45-51 號

其士大廈 6 樓 6 室



[11] 2015694.1M008

[15] 05-03-2020

[51] Cl. 11-01

- [54] 耳環
Earrings
- [73] Lovemark Diamond (HK) Limited
香港九龍
紅磡崇安街 18 號
半島廣場 14 樓 6 室
- [74] Evita Chan
香港九龍尖沙咀
漆咸道南 45-51 號
其士大廈 6 樓 6 室

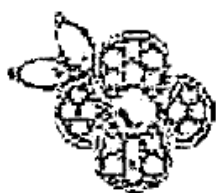

-
- [11] 2015694.1M009
- [15] 05-03-2020
- [51] Cl. 11-01
- [54] 項鍊
Necklace
- [73] Lovemark Diamond (HK) Limited
香港九龍
紅磡崇安街 18 號
半島廣場 14 樓 6 室
- [74] Evita Chan
香港九龍尖沙咀
漆咸道南 45-51 號
其士大廈 6 樓 6 室



[11] 2015694.1M010

[15] 05-03-2020

[51] Cl. 11-01

[54] 項鍊

Necklace

[73] Lovemark Diamond (HK) Limited

香港九龍

紅磡崇安街 18 號

半島廣場 14 樓 6 室

[74] Evita Chan

香港九龍尖沙咀

漆咸道南 45-51 號

其士大廈 6 樓 6 室

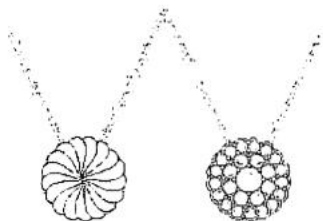

[11] 2015694.1M011

[15] 05-03-2020

[51] Cl. 11-01

- [54] 項鍊
Necklace
- [73] Lovemark Diamond (HK) Limited
香港九龍
紅磡崇安街 18 號
半島廣場 14 樓 6 室
- [74] Evita Chan
香港九龍尖沙咀
漆咸道南 45-51 號
其士大廈 6 樓 6 室



-
- [11] 2015694.1M012
- [15] 05-03-2020
- [51] Cl. 11-01
- [54] 項鍊
Necklace
- [73] Lovemark Diamond (HK) Limited
香港九龍
紅磡崇安街 18 號
半島廣場 14 樓 6 室
- [74] Evita Chan
香港九龍尖沙咀
漆咸道南 45-51 號
其士大廈 6 樓 6 室



[11] 2015694.1M013

[15] 05-03-2020

[51] Cl. 11-01

[54] 項鍊

Necklace

[73] Lovemark Diamond (HK) Limited

香港九龍

紅磡崇安街 18 號

半島廣場 14 樓 6 室

[74] Evita Chan

香港九龍尖沙咀

漆咸道南 45-51 號

其士大廈 6 樓 6 室



[11] 2015694.1M014

[15] 05-03-2020

[51] Cl. 11-01

[54] 項鍊

Necklace

[73] Lovemark Diamond (HK) Limited

香港九龍

紅磡崇安街 18 號

半島廣場 14 樓 6 室

[74] Evita Chan

香港九龍尖沙咀

漆咸道南 45-51 號

其士大廈 6 樓 6 室



[11] 2015694.1M015

[15] 05-03-2020

[51] Cl. 11-01

[54] 戒指

Ring

[73] Lovemark Diamond (HK) Limited

香港九龍

紅磡崇安街 18 號

半島廣場 14 樓 6 室

[74] Evita Chan

香港九龍尖沙咀

漆咸道南 45-51 號

其士大廈 6 樓 6 室



- [11] 2015694.1M016
[15] 05-03-2020
[51] Cl. 11-01
[54] 戒指
Ring
[73] Lovemark Diamond (HK) Limited
香港九龍
紅磡崇安街 18 號
半島廣場 14 樓 6 室
[74] Evita Chan
香港九龍尖沙咀
漆咸道南 45-51 號
其士大廈 6 樓 6 室



-
- [11] 2015694.1M017
[15] 05-03-2020
[51] Cl. 11-01
[54] 戒指
Ring
[73] Lovemark Diamond (HK) Limited
香港九龍
紅磡崇安街 18 號
半島廣場 14 樓 6 室
[74] Evita Chan
香港九龍尖沙咀
漆咸道南 45-51 號
其士大廈 6 樓 6 室



[11] 2015694.1M018

[15] 05-03-2020

[51] Cl. 11-01

[54] 戒指

Ring

[73] Lovemark Diamond (HK) Limited

香港九龍

紅磡崇安街 18 號

半島廣場 14 樓 6 室

[74] Evita Chan

香港九龍尖沙咀

漆咸道南 45-51 號

其士大廈 6 樓 6 室



[11] 2015694.1M019

[15] 05-03-2020

[51] Cl. 11-01

[54] 戒指

Ring

[73] Lovemark Diamond (HK) Limited

香港九龍

紅磡崇安街 18 號

半島廣場 14 樓 6 室

[74] Evita Chan

香港九龍尖沙咀

漆咸道南 45-51 號

其士大廈 6 樓 6 室



- [11] 2015694.1M020
[15] 05-03-2020
[51] Cl. 11-01
[54] 戒指
Ring
[73] Lovemark Diamond (HK) Limited
香港九龍
紅磡崇安街 18 號
半島廣場 14 樓 6 室
[74] Evita Chan
香港九龍尖沙咀
漆咸道南 45-51 號
其士大廈 6 樓 6 室

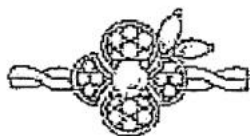

-
- [11] 2015695.4
[15] 05-03-2020
[51] Cl. 23-04
[54] 香薰機
Aroma diffuser
[73] 盛開蓮花有限公司
Bloomy Lotus Ltd
Unit 4711, 47/F., The Center,
99 Queen's Road Central,
Central, Hong Kong
[74] FEDERATION OF HONG KONG INDUSTRIES
31/F, Billion Plaza,
8 Cheung Yue Street,
Cheung Sha Wan, Kowloon,
Hong Kong

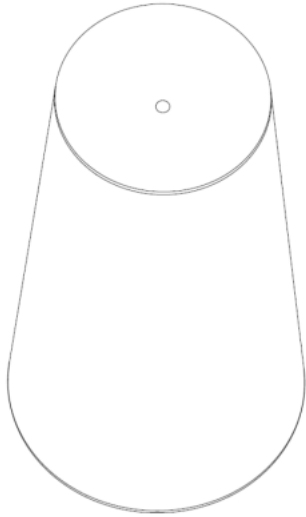

[11] 2015696.6

[15] 05-03-2020

[30] 24-09-2019 / CN / 201930525409.9

[51] C1. 10-07

[54] 錶帶

Watch strap

[73] 北京小米移動軟件有限公司

BEIJING XIAOMI MOBILE SOFTWARE CO., LTD.

中國內地

北京市海澱區西二旗中路

33 號院 6 號樓 8 層 018 號

[74] 香港派特恩知識產權代理有限公司

香港上環

永樂街 121-125 號

永達商業大廈 10 樓 C 室

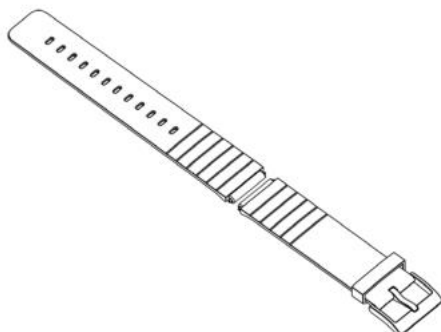

[11] 2015697.8M001

[15] 05-03-2020

[30] 07-10-2019 / NO, SG, CH, EU, JP / DM/205 213

[51] Cl. 9-01

[54] 飲料瓶

Drinking flask

[73] Pi-Design AG

Kantonsstrasse 100,

CH-6234 Triengen,

SWITZERLAND

[74] WENPING PATENT & TRADE MARK AGENT LIMITED

1701 Tung Wai Commercial Building,

111 Gloucester Road,

Hong Kong

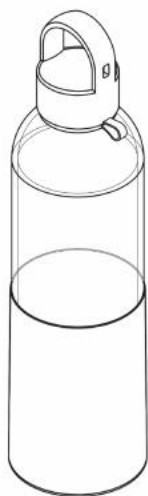

[11] 2015697.8M002

[15] 05-03-2020

[30] 07-10-2019 / NO, SG, CH, EU, JP / DM/205 213

[51] Cl. 9-01

[54] 飲料瓶

Drinking flask

[73] Pi-Design AG

Kantonsstrasse 100,

CH-6234 Triengen,

SWITZERLAND

[74] WENPING PATENT & TRADE MARK AGENT LIMITED

1701 Tung Wai Commercial Building,

111 Gloucester Road,

Hong Kong

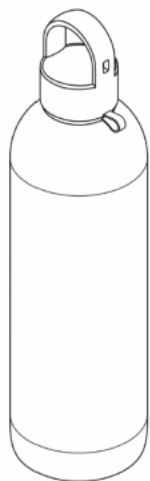

[11] 2015699.2

[15] 05-03-2020

[30] 10-09-2019 / CN / 201930497850.0

[51] Cl. 21-01

[54] 玩具容器

Toy container

[73] 創騰科技發展有限公司

Creative Impact Inc.

Vistra Corporate Services Centre,

Wickhams Cay II,

Road Town, Tortola VG 1110,

Virgin Islands, British

[74] RIBEIRO HUI

6/F, Wilson House,

19-27 Wyndham Street,

Central, Hong Kong

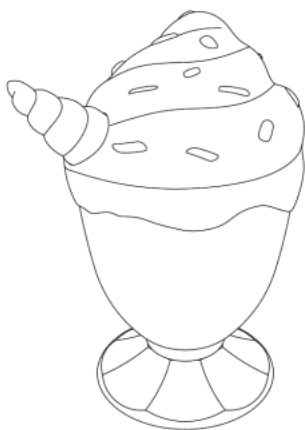

- [11] 2015700.6
[15] 06-03-2020
[51] Cl. 9-05
[54] 管子
Tube
[73] Shiseido Company, Limited
5-5, Ginza 7-chome,
Chuo-ku, Tokyo 104-0061,
JAPAN
[74] MARKS & CLERK
Level 9, Cyberport 1
100 Cyberport Road,
Pok Fu Lam. Hong Kong



-
- [11] 2015701.8M001
[15] 06-03-2020
[30] 19-09-2019 / EU / 006886271
[51] Cl. 23-04
[54] 空氣加濕器
Air humidifier
[73] Koninklijke Philips N.V.
High Tech Campus 52,
5656 AG Eindhoven,
NETHERLANDS
[74] WILKINSON & GRIST
6th Floor, Prince's Building,
Chater Road,
Hong Kong

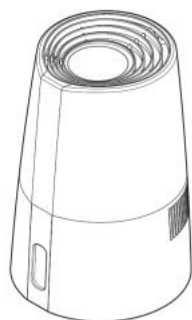

[11] 2015701.8M002

[15] 06-03-2020

[30] 19-09-2019 / EU / 006886271

[51] Cl. 23-04

[54] 空氣加濕器

Air humidifier

[73] Koninklijke Philips N.V.

High Tech Campus 52,

5656 AG Eindhoven,

NETHERLANDS

[74] WILKINSON & GRIST

6th Floor, Prince's Building,

Chater Road,

Hong Kong

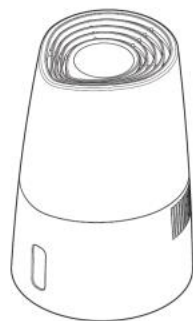

[11] 2015702.0M001

[15] 06-03-2020

[30] 09-09-2019 / US / 29/705,035

[51] Cl. 9-03

[54] 包裝件

Packaging

[73] 蘋果公司

APPLE INC.
ONE APPLE PARK WAY, CUPERTINO,
CALIFORNIA 95014,
UNITED STATES

[74] CLT PATENT & TRADEMARK (H.K.) LIMITED
Unit 09, 34/F., Office Tower, Convention Plaza
No. 1 Harbour Road,
Wanchai, Hong Kong

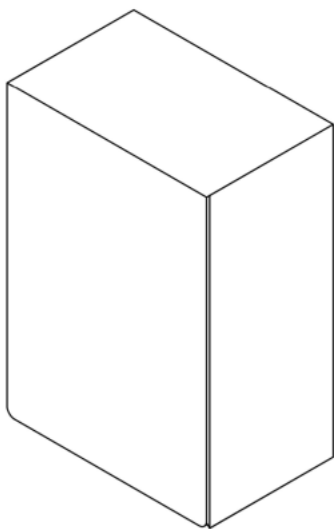

[11] 2015702.0M002

[15] 06-03-2020

[30] 09-09-2019 / US / 29/705,035

[51] Cl. 9-03

[54] 包裝件

Packaging

[73] 蘋果公司

APPLE INC.
ONE APPLE PARK WAY, CUPERTINO,
CALIFORNIA 95014,
UNITED STATES

[74] CLT PATENT & TRADEMARK (H.K.) LIMITED
Unit 09, 34/F., Office Tower, Convention Plaza
No. 1 Harbour Road,
Wanchai, Hong Kong

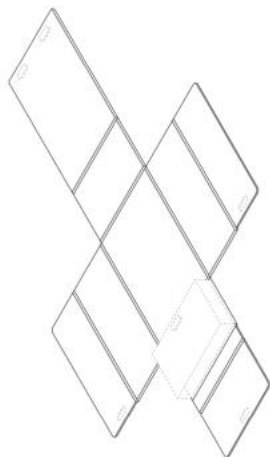

[11] 2015703.2M001

[15] 06-03-2020

[30] 24-09-2019 / CN / 201930525439.X

[51] C1. 10-07

[54] 智能手表表盤

Smart watch dial

[73] 北京小米移動軟件有限公司

BEIJING XIAOMI MOBILE SOFTWARE CO., LTD.

中國內地

北京市海澱區西二旗中路

33 號院 6 號樓 8 層 018 號

[74] 香港派特恩知識產權代理有限公司

香港上環

永樂街 121-125 號

永達商業大廈 10 樓 C 室

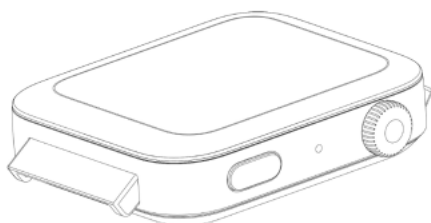

[11] 2015703.2M002

[15] 06-03-2020

[30] 24-09-2019 / CN / 201930525439.X

[51] C1. 10-07

[54] 智能手表表盤

Smart watch dial

[73] 北京小米移動軟件有限公司

BEIJING XIAOMI MOBILE SOFTWARE CO., LTD.

中國內地

北京市海澱區西二旗中路

33 號院 6 號樓 8 層 018 號

[74] 香港派特恩知識產權代理有限公司

香港上環

永樂街 121-125 號

永達商業大廈 10 樓 C 室

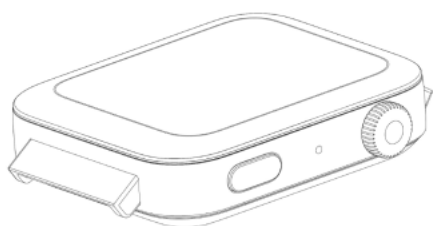

[11] 2015704.4

[15] 06-03-2020

[30] 06-09-2019 / EU / 006832119-0001

[51] Cl. 28-03

[54] 圓柱形旋轉頭化妝刷

Cylindrical swivel head make up brush

[73] Double Take Limited

Grenville Court, Britwell Road

Burnham, Buckinghamshire, SL1 8DF

UNITED KINGDOM

[74] SO KEUNG YIP & SIN

Room 1009-1012, 10/F., Nan Fung Tower,

No. 173 Des Voeux Road Central,

Hong Kong



[11] 2015705.7M001

[15] 06-03-2020

[51] C1. 29-02

[54] 衛生口罩用過濾袋

Filter bag for sanitary mask

[73] ELETEN CO., LTD.

7-16 NISHIAZABU 4-CHOME,
MINATO-KU, TOKYO 106-0031,
JAPAN

[74] CHINA PATENT AGENT (HONG KONG) LIMITED

22/F, Great Eagle Centre,
23 Harbour Road,
Wanchai, Hong Kong

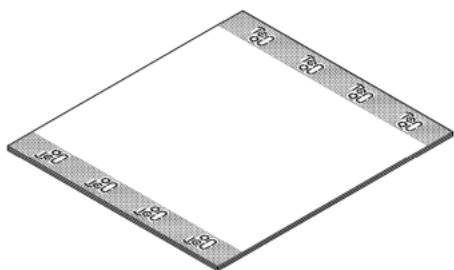

[11] 2015705.7M002

[15] 06-03-2020

[51] C1. 29-02

[54] 衛生口罩用過濾袋

Filter bag for sanitary mask

[73] ELETEN CO., LTD.
7-16 NISHIAZABU 4-CHOME,
MINATO-KU, TOKYO 106-0031,
JAPAN

[74] CHINA PATENT AGENT (HONG KONG) LIMITED
22/F, Great Eagle Centre,
23 Harbour Road,
Wanchai, Hong Kong



[11] 2015705.7M003

[15] 06-03-2020

[51] Cl. 29-02

[54] 衛生口罩用過濾袋
Filter bag for sanitary mask

[73] ELETEN CO., LTD.
7-16 NISHIAZABU 4-CHOME,
MINATO-KU, TOKYO 106-0031,
JAPAN

[74] CHINA PATENT AGENT (HONG KONG) LIMITED
22/F, Great Eagle Centre,
23 Harbour Road,
Wanchai, Hong Kong

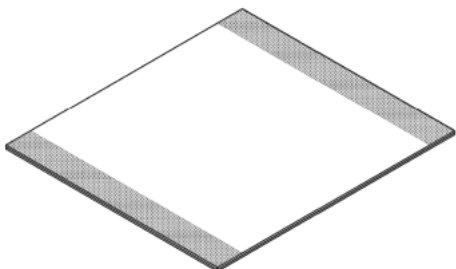

[11] 2015705.7M004

[15] 06-03-2020

[51] Cl. 29-02

- [54] 衛生口罩用過濾袋
Filter bag for sanitary mask
- [73] ELETEN CO., LTD.
7-16 NISHIAZABU 4-CHOME,
MINATO-KU, TOKYO 106-0031,
JAPAN
- [74] CHINA PATENT AGENT (HONG KONG) LIMITED
22/F, Great Eagle Centre,
23 Harbour Road,
Wanchai, Hong Kong

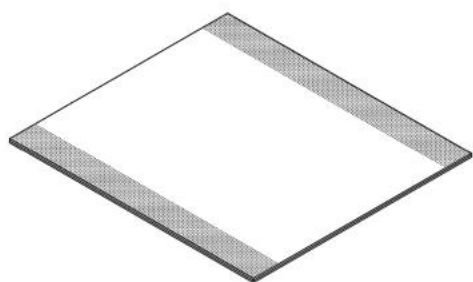

-
- [11] 2015706.9M001
- [15] 06-03-2020
- [30] 12-09-2019 / EU / 006862116
- [51] Cl. 23-01
- [54] 衛生水龍頭
Sanitary faucet
- [73] Hansgrohe SE
Auestr. 5-9,
77761 Schiltach,
GERMANY
- [74] Rouse & Co. International (Overseas) Limited
18/F., Golden Centre,
188 Des Voeux Road Central,
Hong Kong



[11] 2015706.9M002

[15] 06-03-2020

[30] 12-09-2019 / EU / 006862116

[51] Cl. 23-01

[54] 衛生水龍頭底部

Base body for a sanitary faucet

[73] Hansgrohe SE

Austr. 5-9,
77761 Schiltach,
GERMANY

[74] Rouse & Co. International (Overseas) Limited

18/F., Golden Centre,
188 Des Voeux Road Central,
Hong Kong



[11] 2015706.9M003

[15] 06-03-2020

[30] 12-09-2019 / EU / 006862116

[51] Cl. 23-01

[54] 衛生水龍頭

Sanitary faucet

[73] Hansgrohe SE

Auestr. 5-9,

77761 Schiltach,

GERMANY

[74] Rouse & Co. International (Overseas) Limited

18/F., Golden Centre,

188 Des Voeux Road Central,

Hong Kong

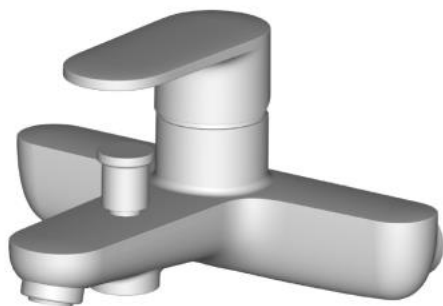

[11] 2015706.9M004

[15] 06-03-2020

[30] 12-09-2019 / EU / 006862116

[51] Cl. 23-01

[54] 衛生裝置

Sanitary fitting

[73] Hansgrohe SE

Auestr. 5-9,

77761 Schiltach,

GERMANY

[74] Rouse & Co. International (Overseas) Limited

18/F., Golden Centre,

188 Des Voeux Road Central,

Hong Kong



[11] 2015706.9M005

[15] 06-03-2020

[30] 12-09-2019 / EU / 006862116

[51] Cl. 23-01

[54] 衛生水龍頭

Sanitary faucet

[73] Hansgrohe SE

Auestr. 5-9,

77761 Schiltach,

GERMANY

[74] Rouse & Co. International (Overseas) Limited

18/F., Golden Centre,

188 Des Voeux Road Central,

Hong Kong



[11] 2015706.9M006

- [15] 06-03-2020
[30] 12-09-2019 / EU / 006862116
[51] Cl. 23-01
[54] 衛生水龍頭底部
Base body for a sanitary faucet
[73] Hansgrohe SE
Auestr. 5-9,
77761 Schiltach,
GERMANY
[74] Rouse & Co. International (Overseas) Limited
18/F., Golden Centre,
188 Des Voeux Road Central,
Hong Kong



-
- [11] 2015706.9M007
[15] 06-03-2020
[30] 12-09-2019 / EU / 006862116
[51] Cl. 23-01
[54] 衛生水龍頭
Sanitary faucet
[73] Hansgrohe SE
Auestr. 5-9,
77761 Schiltach,
GERMANY
[74] Rouse & Co. International (Overseas) Limited
18/F., Golden Centre,
188 Des Voeux Road Central,
Hong Kong

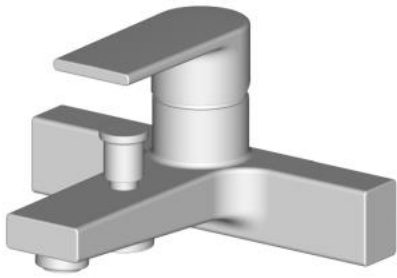

[11] 2015706.9M008

[15] 06-03-2020

[30] 12-09-2019 / EU / 006862116

[51] Cl. 23-01

[54] 衛生裝置

Sanitary fitting

[73] Hansgrohe SE

Auestr. 5-9,

77761 Schiltach,

GERMANY

[74] Rouse & Co. International (Overseas) Limited

18/F., Golden Centre,

188 Des Voeux Road Central,

Hong Kong

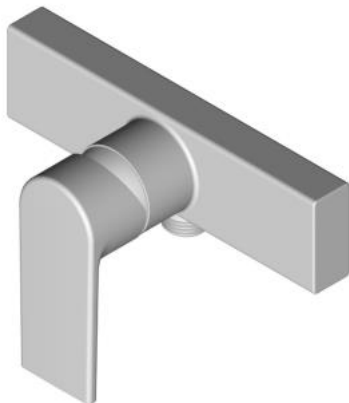

[11] 2015708.3M001

[15] 06-03-2020

[30] 14-10-2019 / EU / 007015284-0001

14-10-2019 / GB / 6073804

[51] Cl. 14-01

[54] 音響裝置

Audio apparatus

[73] Focusrite Audio Engineering Limited

Windsor House Turnpike Road,

High Wycombe,

Buckinghamshire HP12 3FX,

UNITED KINGDOM

[74] CHAN, TANG & KWOK

Rooms 2503-04, 25/F.,

Shanghai Industrial Investment Building,

48-62 Hennessy Road,

Wanchai, Hong Kong

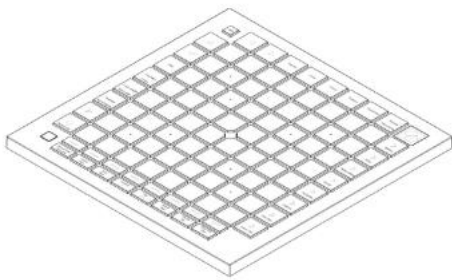

[11] 2015708.3M002

[15] 06-03-2020

[30] 14-10-2019 / EU / 007015284-0002

14-10-2019 / GB / 6073805

[51] Cl. 14-01

[54] 音響裝置

Audio apparatus

[73] Focusrite Audio Engineering Limited

Windsor House Turnpike Road,

High Wycombe,

Buckinghamshire HP12 3FX,

UNITED KINGDOM

[74] CHAN, TANG & KWOK

Rooms 2503-04, 25/F.,

Shanghai Industrial Investment Building,

48-62 Hennessy Road,

Wanchai, Hong Kong



[11] 2015708.3M003

[15] 06-03-2020

[30] 14-10-2019 / EU / 007015284-0003
14-10-2019 / GB / 6073806

[51] Cl. 14-01

[54] 音響裝置

Audio apparatus

[73] Focusrite Audio Engineering Limited

Windsor House Turnpike Road,

High Wycombe,

Buckinghamshire HP12 3FX,

UNITED KINGDOM

[74] CHAN, TANG & KWOK

Rooms 2503-04, 25/F.,

Shanghai Industrial Investment Building,

48-62 Hennessy Road,

Wanchai, Hong Kong

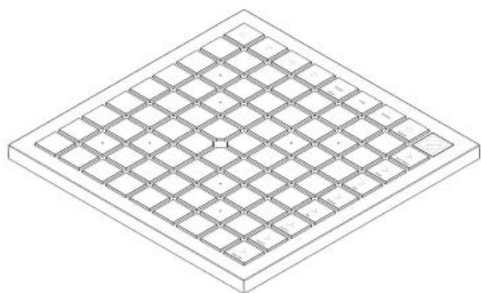

[11] 2015708.3M004

[15] 06-03-2020

[30] 14-10-2019 / EU / 007015284-0004
14-10-2019 / GB / 6073807

[51] Cl. 14-01

[54] 音響裝置
Audio apparatus

[73] Focusrite Audio Engineering Limited
Windsor House Turnpike Road,
High Wycombe,
Buckinghamshire HP12 3FX,
UNITED KINGDOM

[74] CHAN, TANG & KWOK
Rooms 2503-04, 25/F.,
Shanghai Industrial Investment Building,
48-62 Hennessy Road,
Wanchai, Hong Kong



[11] 2015708.3M005

[15] 06-03-2020

[30] 14-10-2019 / GB / 6073808
14-10-2019 / EU / 007015284-0005

[51] Cl. 14-01

[54] 音響裝置
Audio apparatus

[73] Focusrite Audio Engineering Limited
Windsor House Turnpike Road,
High Wycombe,
Buckinghamshire HP12 3FX,
UNITED KINGDOM

[74] CHAN, TANG & KWOK
Rooms 2503-04, 25/F.,
Shanghai Industrial Investment Building,
48-62 Hennessy Road,
Wanchai, Hong Kong

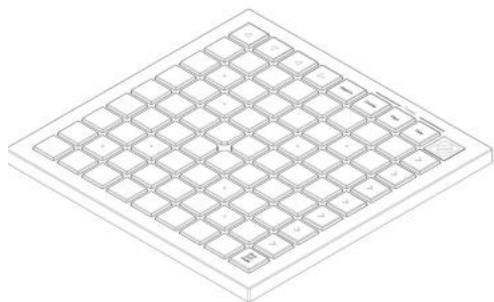

[11] 2015708.3M006

[15] 06-03-2020

[30] 14-10-2019 / GB / 6073809

14-10-2019 / EU / 007015284-0006

[51] Cl. 14-01

[54] 音響裝置

Audio apparatus

[73] Focusrite Audio Engineering Limited

Windsor House Turnpike Road,

High Wycombe,

Buckinghamshire HP12 3FX,

UNITED KINGDOM

[74] CHAN, TANG & KWOK

Rooms 2503-04, 25/F.,

Shanghai Industrial Investment Building,

48-62 Hennessy Road,

Wanchai, Hong Kong

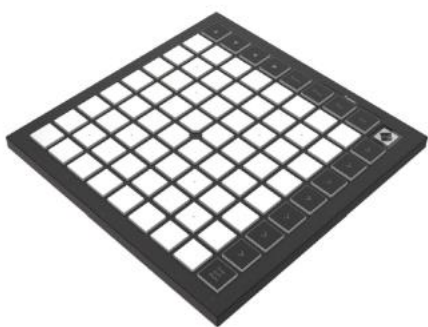

[11] 2015710.7

[15] 06-03-2020

[51] Cl. 6-01

[54] Leisure chair

休閒椅

[73] 艾克西德（北京）科技有限公司
EXCEED (BEIJING) TECHNOLOGY CO.,LTD.
中國內地
北京市門頭溝區石龍經濟開發區永安路
20 號 3 號樓 A-6844 室 100000

[74] HONG KONG UTC INTELLECTUAL PROPERTY (HOLDINGS) LIMITED
香港
金鐘道 89 號
力寶中心 2 座 11 樓 1105 室



[11] 2015712.1

[15] 06-03-2020

[30] 06-09-2019 / CH / 144876

[51] Cl. 10-02

[54] 手錶
Watch

[73] Sowind SA
Place Girardet 1,
2301 La Chaux-de-Fonds,
SWITZERLAND

[74] ATL LAW OFFICES
16/F., China Hong Kong Tower,
8-12 Hennessy Road,
Wanchai, Hong Kong



[11] 2015713.3M001

[15] 09-03-2020

[30] 09-09-2019 / US / 29/705,037

[51] Cl. 3-01

[54] 用於電子裝置的殼

Case for electronic device

[73] 蘋果公司

APPLE INC.

ONE APPLE PARK WAY, CUPERTINO,

CALIFORNIA 95014,

UNITED STATES

[74] CLT PATENT & TRADEMARK (H.K.) LIMITED

Unit 09, 34/F., Office Tower, Convention Plaza,

No. 1 Harbour Road,

Wanchai, Hong Kong

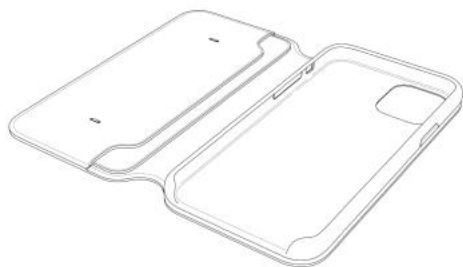

[11] 2015713.3M002

[15] 09-03-2020

[30] 09-09-2019 / US / 29/705,037

[51] Cl. 3-01

[54] 用於電子裝置的殼

Case for electronic device

[73] 蘋果公司

APPLE INC.

ONE APPLE PARK WAY, CUPERTINO,

CALIFORNIA 95014,
UNITED STATES

[74] CLT PATENT & TRADEMARK (H.K.) LIMITED
Unit 09, 34/F., Office Tower, Convention Plaza,
No. 1 Harbour Road,
Wanchai, Hong Kong

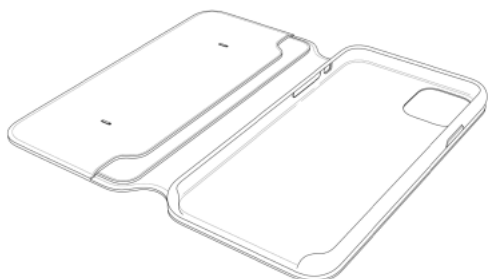

[11] 2015715.8M001

[15] 09-03-2020

[30] 09-09-2019 / US / 29/705,040

[51] Cl. 14-03

Cl. 14-02

Cl. 14-01

[54] 電子裝置
Electronic device

[73] 蘋果公司
APPLE INC.
ONE APPLE PARK WAY, CUPERTINO,
CALIFORNIA 95014
UNITED STATES

[74] CLT PATENT & TRADEMARK (H.K.) LIMITED
Unit 09, 34/F., Office Tower, Convention Plaza,
No. 1 Harbour Road,
Wanchai, Hong Kong



- [11] 2015715.8M002
[15] 09-03-2020
[30] 09-09-2019 / US / 29/705,040
[51] Cl. 14-03
Cl. 14-02
Cl. 14-01
[54] 電子裝置
Electronic device
[73] 蘋果公司
APPLE INC.
ONE APPLE PARK WAY, CUPERTINO,
CALIFORNIA 95014
UNITED STATES
[74] CLT PATENT & TRADEMARK (H.K.) LIMITED
Unit 09, 34/F., Office Tower, Convention Plaza,
No. 1 Harbour Road,
Wanchai, Hong Kong



-
- [11] 2015716.0
[15] 09-03-2020
[30] 10-09-2019 / JP / 020205 of 2019
[51] Cl. 9-01
[54] 容器
Container
[73] 科研製藥株式會社
KAKEN PHARMACEUTICAL CO., LTD.
28-8, Honkomagome 2-chome,
Bunkyo-ku, Tokyo 1138650,
JAPAN
[74] CHINA PATENT AGENT (HONG KONG) LIMITED
22/F, Great Eagle Centre,

23 Harbour Road,
Wanchai, Hong Kong



[11] 2015717.2M001

[15] 09-03-2020

[30] 09-09-2019 / JP / 020099 of 2019

[51] Cl. 19-06

[54] 圓珠筆

Ballpoint pen

[73] KABUSHIKI KAISHA PILOT CORPORATION (PILOT CORPORATION)

6-21, KYOBASHI 2-CHOME,
CHUO-KU, TOKYO 104-8304,
JAPAN

[74] CHINA PATENT AGENT (HONG KONG) LIMITED

22/F, Great Eagle Centre,
23 Harbour Road,
Wanchai, Hong Kong

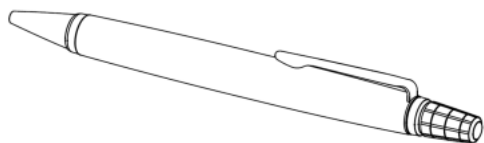

[11] 2015717.2M002

[15] 09-03-2020

[30] 09-09-2019 / JP / 020102 of 2019

[51] Cl. 19-06

[54] 鋼筆

Fountain pen

[73] KABUSHIKI KAISHA PILOT CORPORATION (PILOT CORPORATION)

6-21, KYOBASHI 2-CHOME,
CHUO-KU, TOKYO 104-8304,
JAPAN

[74] CHINA PATENT AGENT (HONG KONG) LIMITED

22/F, Great Eagle Centre,
23 Harbour Road,
Wanchai, Hong Kong

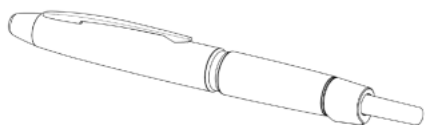

[11] 2015719.6

[15] 09-03-2020

[30] 10-09-2019 / US / 29/705,238

[51] Cl. 3-01

[54] 用於電子設備的外殼

Case for an electronic device

[73] 蘋果公司

APPLE INC.
ONE APPLE PARK WAY, CUPERTINO,
CALIFORNIA 95014,
UNITED STATES

[74] CLT PATENT & TRADEMARK (H.K.) LIMITED

Unit 09, 34/F., Office Tower, Convention Plaza,
No. 1 Harbour Road,
Wanchai, Hong Kong

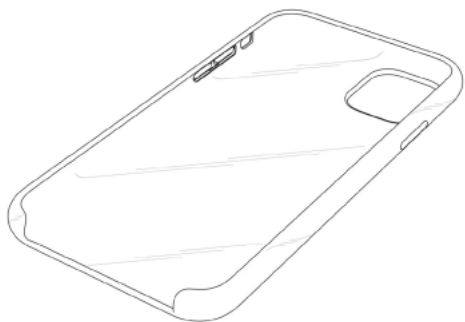

[11] 2015720.8

[15] 09-03-2020

[30] 09-09-2019 / US / 29/705,075

[51] Cl. 3-01

[54] 用於電子設備的外殼

Case for an electronic device

[73] 蘋果公司

APPLE INC.

ONE APPLE PARK WAY, CUPERTINO,

CALIFORNIA 95014,

UNITED STATES

[74] CLT PATENT & TRADEMARK (H.K.) LIMITED

Unit 09, 34/F., Office Tower, Convention Plaza,

No. 1 Harbour Road,

Wanchai, Hong Kong





香港特別行政區政府知識產權署外觀設計註冊處

The Government of the Hong Kong Special Administrative Region

Designs Registry, Intellectual Property Department

根據註冊外觀設計條例第 28 條，下列註冊外觀設計因未繳續期費而停止有效。

各組記項按註冊外觀設計停止有效日期及註冊編號先後次序排列。

Registered designs ceased through non-payment of renewal fees under section 28 of the Registered Designs Ordinance. Entries are listed below under their expiry dates.

21-05-2020 - 26-05-2020

21-05-2020	1000963.3
1501064.2	1000964.5
1501093.3	1000966.0
1501094.5	1000967.2
1501095.8	1000968.4
1501096.0	1000969.6
1501097.2	1000970.8
1501098.4	1000971.0
1501099.6	1000972.2
1501100.0	1000973.4
1501101.2	1000974.6
1501102.4	1000978.5
1501103.6	1000980.9
1501104.8	1501112.5
1501110.1	1501117.6
	1501118.8
22-05-2020	1501119.0
0501205.1	1501121.4
	1501122.6
23-05-2020	1501123.8M001
1000944.3	1501123.8M002
1000945.6	
1000946.8	26-05-2020
1000949.4	1000989.8
	1000990.0
24-05-2020	1000991.2
0501227.7M001	1501070.5
0501227.7M002	1501127.7
0501233.9M001	
0501233.9M002	
25-05-2020	
0010640.9	
1000962.1	



香港特別行政區政府知識產權署外觀設計註冊處

The Government of the Hong Kong Special Administrative Region

Designs Registry, Intellectual Property Department

根據註冊外觀設計規則第 31 條刪除的註冊外觀設計。各組記項按註冊外觀設計刪除日期及註冊編號先後次序排列。

Registered designs removed under section 31 of the Registered Designs Rules. Entries are listed below under their removal dates.

03-07-2020 - 08-07-2020

03-07-2020	1402159.4M004	1402182.2
0412648.2M001	1402159.4M005	1402184.6
0412648.2M002	1402159.4M006	1402185.9
0412648.2M003	1402161.8	1402186.1
0412648.2M004	1402163.2	1402190.9M001
0412648.2M005	1402165.7	1402190.9M002
0412648.2M006	1402167.1	1402191.1M001
0412648.2M007	1402168.3	1402191.1M002
0412648.2M008	9911594.9	1402191.1M003
0412648.2M009		1402191.1M004
0412648.2M010	07-07-2020	1402191.1M005
0412649.4M001	0412678.5	1402191.1M006
0412649.4M002	0412680.9M001	1402191.1M007
0412649.4M003	0901964.3	1402191.1M008
0412649.4M004	0901965.6	1402192.3M001
0412650.6M001	1402149.3	1402192.3M002
0412650.6M002	1402170.7	
0412650.6M003	1402171.9	
0412650.6M004	1402172.1	
	1402176.0M001	
05-07-2020	1402176.0M002	
0412660.7M001	1402177.2	
0412660.7M002	1402178.4	
0901957.9	9911600.4	
1402151.7	9911601.6M001	
1402152.9	9911601.6M002	
	9911602.8	
06-07-2020		
0412676.1	08-07-2020	
1402156.8	0901978.3M002	
1402157.0	0901978.3M003	
1402159.4M001	0901980.7	
1402159.4M002	1402169.5	
1402159.4M003	1402181.0	



香港特別行政區政府知識產權署外觀設計註冊處

The Government of the Hong Kong Special Administrative Region

Designs Registry, Intellectual Property Department

已在官方公報刊登的外觀設計公告內的聲稱具有優先權更正如下:

The following show the corrected priority claim in advertisement previously published in the official journal:

官方公報日期 Official journal date 05.06.2020

[11] 1913488.9

[30] 22-10-2018 / FR / 2019-2963