

香港知識產權公報

Hong Kong Intellectual Property Journal

2020年12月24日
24 December 2020

目錄 Contents

根據註冊外觀設計條例第 25 條註冊的外觀設計

Designs Registered under section 25 of the Registered Designs Ordinance

按註冊編號排列

Arranged by Registration Number

根據註冊外觀設計條例(第 522 章)公布的其他公告

Other Notices Published under the Registered Designs Ordinance (Cap. 522)

根據註冊外觀設計條例第 28 條，註冊外觀設計因未繳續期費而停止有效

Registered designs ceased through non-payment of renewal fees under section 28 of the Registered Designs Ordinance

根據註冊外觀設計規則第 31 條刪除的註冊外觀設計

Registered designs removed under section 31 of the Registered Designs Rules

以下事項沒有記錄

No Records for the Following Matters

根據註冊外觀設計條例第 30 條放棄的外觀設計的註冊

Surrender of Registration of Design under section 30 of the Registered Designs Ordinance

根據註冊外觀設計規則第 37 條，向處長作出轉介

Reference to Registrar under section 37 of the Registered Designs Rules

根據註冊外觀設計條例第 45 條，撤銷註冊

Revocation of Registration under section 45 of the Registered Designs Ordinance

根據註冊外觀設計規則第 46 條，向法院作出轉介

Reference to Court under section 46 of the Registered Designs Rules

根據註冊外觀設計規則第 63 條對不符合規定之處作出糾正

Rectification of Irregularities under section 63 of the Registered Designs Rules

根據註冊外觀設計條例第 66 條，糾正註冊紀錄冊

Rectification of Register under section 66 of the Registered Designs Ordinance

根據註冊外觀設計條例第 67 條 更正註冊紀錄冊內的錯誤

Correction of errors in Register under section 67 of the Registered Designs Ordinance

根據註冊外觀設計條例第 67 及 76 條，更正註冊紀錄冊內及已提交文件中的錯誤

Correction of Errors in Register and in Filed Documents under sections 67 and 76 of the Registered Designs Ordinance

根據註冊外觀設計條例第 76 條，更正已提交文件中的錯誤

Correction of errors in filed documents under section 76 of the Registered Designs Ordinance

勘誤

Corrigendum

註冊外觀設計公告註釋

Notes on advertisements of registration of designs

方括號表示下列資料：

Square brackets indicate the following data：

[11] 註冊編號 Registration number / 聯合王國註冊編號 United Kingdom registration number

[15] 註冊日期 Registration date / 當作註冊日期 Deemed registration date / 聯合王國註冊日期 United Kingdom registration date

[17] 註冊有效期屆滿日期 Expiry date of the period of registration

[22] 提交日期 Filing date / 當作提交日期 Deemed filing date / 聯合王國提交日期 United Kingdom filing date

[30] 聲稱享有的優先權（提交日期 / 巴黎公約國或世界貿易組織成員 / 申請編號） Priority claimed (filing date / Paris Convention country or WTO member / application number)

[51] 國際外觀設計分類號（洛迦諾分類號） International Classification of designs (Locarno Classification)

[54] 物品 Article

[55] 外觀設計的表述 Representation of the design

[62] 分開前的申請編號及提交日期 Application number before division and filing date

[66] 過往註冊的聯繫外觀設計註冊編號 / 日期 Registration No. / Date of Previous Registration for Association

[72] 設計人 Designer

[73] 擁有人姓名和地址 Name and address of the owner

[74] 代理人 Agent / 送達地址 Address for service



香港特別行政區政府知識產權署外觀設計註冊處

The Government of the Hong Kong Special Administrative Region

Designs Registry, Intellectual Property Department

根據註冊外觀設計條例第 25 條註冊的外觀設計

Designs registered under section 25 of the Registered Designs Ordinance

按註冊編號排列

Arranged by Registration Number

- [11] 2016201.8M001
- [15] 22-05-2020
- [30] 22-11-2019 / US / 29/714,473
- [51] Cl. 14-03
Cl. 14-02
Cl. 14-01
- [54] 電子裝置
Electronic device
- [73] 蘋果公司
APPLE INC.
One Apple Park Way, Cupertino,
California 95014,
United States
- [74] CLT PATENT & TRADEMARK (H.K.) LIMITED
Unit 09, 34/F., Office Tower, Convention Plaza,
No. 1 Harbour Road,
Wanchai, Hong Kong



-
- [11] 2016201.8M002
 - [15] 22-05-2020
 - [30] 22-11-2019 / US / 29/714,473
 - [51] Cl. 14-03
Cl. 14-02
Cl. 14-01

[54] 電子裝置
Electronic device

[73] 蘋果公司
APPLE INC.
One Apple Park Way, Cupertino,
California 95014,
United States

[74] CLT PATENT & TRADEMARK (H.K.) LIMITED
Unit 09, 34/F., Office Tower, Convention Plaza,
No. 1 Harbour Road,
Wanchai, Hong Kong



[11] 2016201.8M003

[15] 22-05-2020

[30] 22-11-2019 / US / 29/714,473

[51] Cl. 14-03
Cl. 14-02
Cl. 14-01

[54] 電子裝置
Electronic device

[73] 蘋果公司
APPLE INC.
One Apple Park Way, Cupertino,
California 95014,
United States

[74] CLT PATENT & TRADEMARK (H.K.) LIMITED
Unit 09, 34/F., Office Tower, Convention Plaza,
No. 1 Harbour Road,
Wanchai, Hong Kong



[11] 2016201.8M004

[15] 22-05-2020

[30] 22-11-2019 / US / 29/714,473

[51] Cl. 14-03

Cl. 14-02

Cl. 14-01

[54] 電子裝置

Electronic device

[73] 蘋果公司

APPLE INC.

One Apple Park Way, Cupertino,

California 95014,

United States

[74] CLT PATENT & TRADEMARK (H.K.) LIMITED

Unit 09, 34/F., Office Tower, Convention Plaza,

No. 1 Harbour Road,

Wanchai, Hong Kong

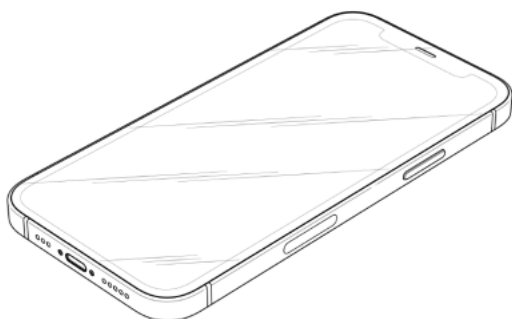

- [11] 2016201.8M005
[15] 22-05-2020
[30] 22-11-2019 / US / 29/714,473
[51] Cl. 14-03
Cl. 14-02
Cl. 14-01
[54] 電子裝置
Electronic device
[73] 蘋果公司
APPLE INC.
One Apple Park Way, Cupertino,
California 95014,
United States
[74] CLT PATENT & TRADEMARK (H.K.) LIMITED
Unit 09, 34/F., Office Tower, Convention Plaza,
No. 1 Harbour Road,
Wanchai, Hong Kong

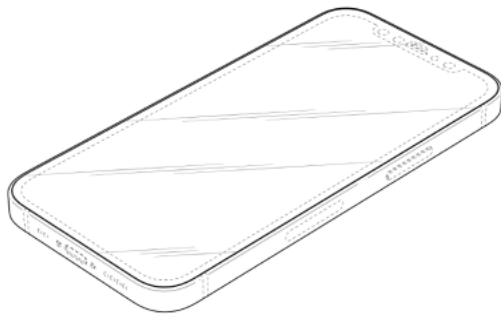

-
- [11] 2016201.8M006
[15] 22-05-2020
[30] 22-11-2019 / US / 29/714,473
[51] Cl. 14-03
Cl. 14-02
Cl. 14-01
[54] 電子裝置
Electronic device
[73] 蘋果公司
APPLE INC.
One Apple Park Way, Cupertino,
California 95014,
United States
[74] CLT PATENT & TRADEMARK (H.K.) LIMITED
Unit 09, 34/F., Office Tower, Convention Plaza,

No. 1 Harbour Road,
Wanchai, Hong Kong

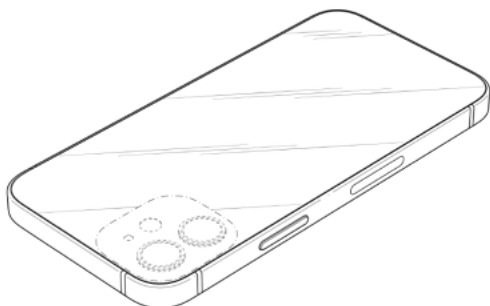

[11] 2016201.8M007

[15] 22-05-2020

[30] 22-11-2019 / US / 29/714,473

[51] Cl. 14-03

Cl. 14-02

Cl. 14-01

[54] 電子裝置

Electronic device

[73] 蘋果公司

APPLE INC.

One Apple Park Way, Cupertino,

California 95014,

United States

[74] CLT PATENT & TRADEMARK (H.K.) LIMITED

Unit 09, 34/F., Office Tower, Convention Plaza,

No. 1 Harbour Road,

Wanchai, Hong Kong



[11] 2016201.8M008

- [15] 22-05-2020
- [30] 22-11-2019 / US / 29/714,473
- [51] Cl. 14-03
Cl. 14-02
Cl. 14-01
- [54] 電子裝置
Electronic device
- [73] 蘋果公司
APPLE INC.
One Apple Park Way, Cupertino,
California 95014,
United States
- [74] CLT PATENT & TRADEMARK (H.K.) LIMITED
Unit 09, 34/F., Office Tower, Convention Plaza,
No. 1 Harbour Road,
Wanchai, Hong Kong



-
- [11] 2016201.8M009
- [15] 22-05-2020
- [30] 22-11-2019 / US / 29/714,473
- [51] Cl. 14-03
Cl. 14-02
Cl. 14-01
- [54] 電子裝置
Electronic device
- [73] 蘋果公司
APPLE INC.
One Apple Park Way, Cupertino,
California 95014,
United States
- [74] CLT PATENT & TRADEMARK (H.K.) LIMITED
Unit 09, 34/F., Office Tower, Convention Plaza,
No. 1 Harbour Road,
Wanchai, Hong Kong



[11] 2016201.8M010

[15] 22-05-2020

[30] 22-11-2019 / US / 29/714,473

[51] Cl. 14-03

Cl. 14-02

Cl. 14-01

[54] 電子裝置

Electronic device

[73] 蘋果公司

APPLE INC.

One Apple Park Way, Cupertino,

California 95014,

United States

[74] CLT PATENT & TRADEMARK (H.K.) LIMITED

Unit 09, 34/F., Office Tower, Convention Plaza,

No. 1 Harbour Road,

Wanchai, Hong Kong



[11] 2016201.8M011

[15] 22-05-2020

[30] 22-11-2019 / US / 29/714,473

[51] Cl. 14-03
Cl. 14-02
Cl. 14-01

[54] 電子裝置
Electronic device

[73] 蘋果公司
APPLE INC.
One Apple Park Way, Cupertino,
California 95014,
United States

[74] CLT PATENT & TRADEMARK (H.K.) LIMITED
Unit 09, 34/F., Office Tower, Convention Plaza,
No. 1 Harbour Road,
Wanchai, Hong Kong



[11] 2016201.8M012

[15] 22-05-2020

[30] 22-11-2019 / US / 29/714,473

[51] Cl. 14-03
Cl. 14-02
Cl. 14-01

[54] 電子裝置
Electronic device

[73] 蘋果公司
APPLE INC.
One Apple Park Way, Cupertino,
California 95014,
United States

[74] CLT PATENT & TRADEMARK (H.K.) LIMITED
Unit 09, 34/F., Office Tower, Convention Plaza,
No. 1 Harbour Road,
Wanchai, Hong Kong



[11] 2016201.8M013

[15] 22-05-2020

[30] 22-11-2019 / US / 29/714,473

[51] Cl. 14-03

Cl. 14-02

Cl. 14-01

[54] 電子裝置

Electronic device

[73] 蘋果公司

APPLE INC.

One Apple Park Way, Cupertino,

California 95014,

United States

[74] CLT PATENT & TRADEMARK (H.K.) LIMITED

Unit 09, 34/F., Office Tower, Convention Plaza,

No. 1 Harbour Road,

Wanchai, Hong Kong



[11] 2016201.8M014

[15] 22-05-2020

[30] 22-11-2019 / US / 29/714,473

[51] Cl. 14-03

Cl. 14-02

Cl. 14-01

[54] 電子裝置

Electronic device

[73] 蘋果公司

APPLE INC.

One Apple Park Way, Cupertino,

California 95014,

United States

[74] CLT PATENT & TRADEMARK (H.K.) LIMITED

Unit 09, 34/F., Office Tower, Convention Plaza,

No. 1 Harbour Road,

Wanchai, Hong Kong



[11] 2016201.8M015

[15] 22-05-2020

[30] 22-11-2019 / US / 29/714,473

[51] Cl. 14-03

Cl. 14-02

Cl. 14-01

[54] 電子裝置

Electronic device

[73] 蘋果公司

APPLE INC.

One Apple Park Way, Cupertino,

California 95014,

United States

[74] CLT PATENT & TRADEMARK (H.K.) LIMITED

Unit 09, 34/F., Office Tower, Convention Plaza,

No. 1 Harbour Road,

Wanchai, Hong Kong

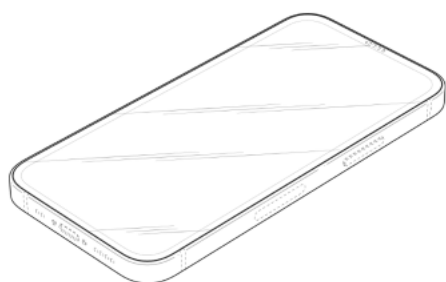

[11] 2016201.8M016

[15] 22-05-2020

[30] 22-11-2019 / US / 29/714,473

[51] Cl. 14-03

Cl. 14-02

Cl. 14-01

[54] 電子裝置

Electronic device

[73] 蘋果公司

APPLE INC.

One Apple Park Way, Cupertino,

California 95014,

United States

[74] CLT PATENT & TRADEMARK (H.K.) LIMITED

Unit 09, 34/F., Office Tower, Convention Plaza,

No. 1 Harbour Road,

Wanchai, Hong Kong



[11] 2016201.8M017

[15] 22-05-2020

[30] 22-11-2019 / US / 29/714,473

[51] Cl. 14-03
Cl. 14-02
Cl. 14-01

[54] 電子裝置
Electronic device

[73] 蘋果公司
APPLE INC.
One Apple Park Way, Cupertino,
California 95014,
United States

[74] CLT PATENT & TRADEMARK (H.K.) LIMITED
Unit 09, 34/F., Office Tower, Convention Plaza,
No. 1 Harbour Road,
Wanchai, Hong Kong

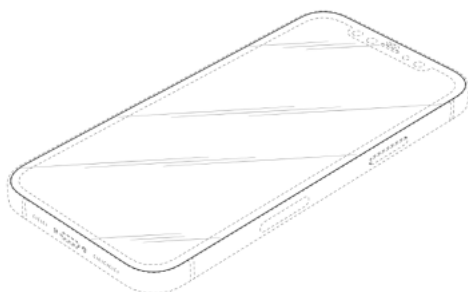

[11] 2016273.9M001

[15] 04-06-2020

[30] 04-12-2019 / EU / 007338355-0001

[51] Cl. 9-03

[54] 包裝用的紋飾
Ornamentation for packaging

[73] Essity Hygiene and Health Aktiebolag
405 03 Göteborg,
Sweden

[74] DEACONS
5th Floor, Alexandra House,
Central,
Hong Kong



[11] 2016273.9M002

[15] 04-06-2020

[30] 04-12-2019 / EU / 007338355-0002

[51] Cl. 9-03

[54] 包裝用的紋飾

Ornamentation for packaging

[73] Essity Hygiene and Health Aktiebolag

405 03 Göteborg,

Sweden

[74] DEACONS

5th Floor, Alexandra House,

Central,

Hong Kong

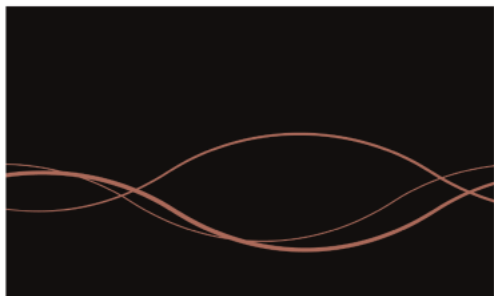

[11] 2016273.9M003

[15] 04-06-2020

[30] 04-12-2019 / EU / 007338355-0003

[51] Cl. 9-03

[54] 包裝用的紋飾

Ornamentation for packaging

[73] Essity Hygiene and Health Aktiebolag

405 03 Göteborg,

Sweden

- [74] DEACONS
5th Floor, Alexandra House,
Central,
Hong Kong

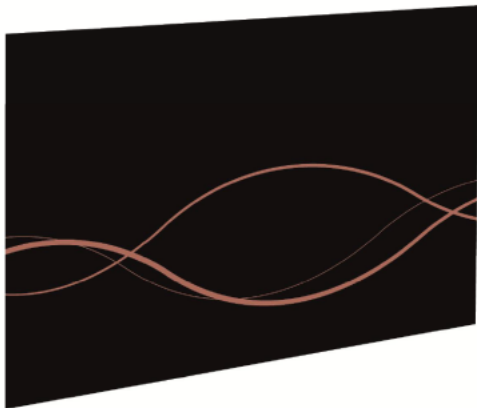

-
- [11] 2016273.9M004
[15] 04-06-2020
[30] 04-12-2019 / EU / 007338355-0004
[51] Cl. 9-03
[54] 包裝用的紋飾
Ornamentation for packaging
[73] Essity Hygiene and Health Aktiebolag
405 03 Göteborg,
Sweden
[74] DEACONS
5th Floor, Alexandra House,
Central,
Hong Kong

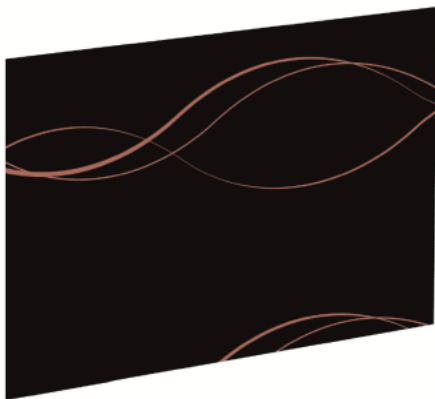

- [11] 2016273.9M005
[15] 04-06-2020
[30] 04-12-2019 / EU / 007338355-0021
[51] Cl. 9-03
[54] 包裝用的紋飾
Ornamentation for packaging
[73] Essity Hygiene and Health Aktiebolag
405 03 Göteborg,
Sweden
[74] DEACONS
5th Floor, Alexandra House,
Central,
Hong Kong

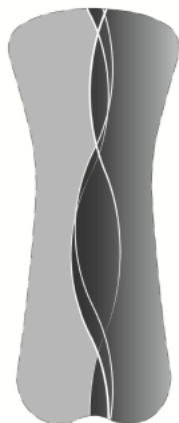

-
- [11] 2016712.2
[15] 26-08-2020
[51] Cl. 21-01
[54] 立體金屬拼圖
3-Dimensional metallic puzzle
[73] 華山國際貿易有限公司
Hanayama International Trading Limited
Flat A, 7/F,
No.1 Chatham Road South,
Tsim Sha Tsui, Kowloon, Hong Kong
[74] Ms Cansi Wong (Hanayama International Trading Limited)
Flat A, 7/F,
No.1 Chatham Road South,
Tsim Sha Tsui, Kowloon, Hong Kong



[11] 2016716.1

[15] 27-08-2020

[51] Cl. 19-02

[54] 伸縮式扣件
Retractable buckle

[73] 蔡海濱
TSAI HAI PIN
香港九龍觀塘
鴻圖道 57 號
南洋廣場 1805 室

[74] TOMBO INDUSTRIES CO., LTD.
香港九龍
觀塘鴻圖道 57 號
南洋廣場 1805 室

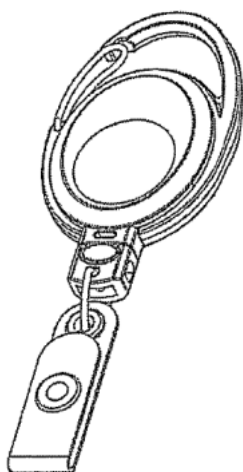

[11] 2016717.3

[15] 27-08-2020

[30] 10-03-2020 / DE / 40 2020 100 241.0

[51] Cl. 21-01

[54] 玩具車

Toy vehicle

[73] VOLKSWAGEN AKTIENGESELLSCHAFT

Berliner Ring 2,

38440 Wolfsburg,

Germany

[74] CHINA PATENT AGENT (HONG KONG) LIMITED

22/F, Great Eagle Centre,

23 Harbour Road,

Wanchai, Hong Kong



[11] 2016718.5

[15] 27-08-2020

[30] 10-03-2020 / DE / 40 2020 100 241.0

[51] Cl. 12-08

[54] 汽車

Motor vehicle

[73] VOLKSWAGEN AKTIENGESELLSCHAFT

Berliner Ring 2,

38440 Wolfsburg,

Germany

[74] CHINA PATENT AGENT (HONG KONG) LIMITED

22/F, Great Eagle Centre,

23 Harbour Road,

Wanchai, Hong Kong



[11] 2016719.7M001

[15] 27-08-2020

[30] 27-03-2020 / CA, AM, AZ, BZ, BA, GE, LI, MK, MD, MC, MN, ME,
NO, OM, SG, CH, TN, TR, UA, GB, EU, AL, KG / DM/207 214

[51] Cl. 11-01

[54] 項鍊

Necklace

[73] Harry Winston SA

Chemin du Tourbillon 8,
CH-1228 Plan-les-Ouates,
Switzerland

[74] SPRUSON & FERGUSON (HONG KONG) LIMITED

5001 Hopewell Centre,
183 Queen's Road East,
Wan Chai, Hong Kong



[11] 2016719.7M002

[15] 27-08-2020

[30] 27-03-2020 / CA, AM, AZ, BZ, BA, GE, LI, MK, MD, MC, MN, ME,
NO, OM, SG, CH, TN, TR, UA, GB, EU, AL, KG / DM/207 214

[51] Cl. 11-01

[54] 項鍊

Necklace

[73] Harry Winston SA

Chemin du Tourbillon 8,
CH-1228 Plan-les-Ouates,
Switzerland

[74] SPRUSON & FERGUSON (HONG KONG) LIMITED

5001 Hopewell Centre,
183 Queen's Road East,
Wan Chai, Hong Kong



[11] 2016719.7M003

[15] 27-08-2020

[30] 27-03-2020 / CA, AM, AZ, BZ, BA, GE, LI, MK, MD, MC, MN, ME,
NO, OM, SG, CH, TN, TR, UA, GB, EU, AL, KG / DM/207 214

[51] Cl. 11-01

[54] 指環
Ring

[73] Harry Winston SA
Chemin du Tourbillon 8,
CH-1228 Plan-les-Ouates,
Switzerland

[74] SPRUSON & FERGUSON (HONG KONG) LIMITED
5001 Hopewell Centre,
183 Queen's Road East,
Wan Chai, Hong Kong



[11] 2016719.7M004

[15] 27-08-2020

[30] 27-03-2020 / CA, AM, AZ, BZ, BA, GE, LI, MK, MD, MC, MN, ME,
NO, OM, SG, CH, TN, TR, UA, GB, EU, AL, KG / DM/207 214

[51] Cl. 11-01

[54] 手鐲
Bracelet

- [73] Harry Winston SA
Chemin du Tourbillon 8,
CH-1228 Plan-les-Ouates,
Switzerland
- [74] SPRUSON & FERGUSON (HONG KONG) LIMITED
5001 Hopewell Centre,
183 Queen's Road East,
Wan Chai, Hong Kong



-
- [11] 2016719.7M005
- [15] 27-08-2020
- [30] 27-03-2020 / CA, AM, AZ, BZ, BA, GE, LI, MK, MD, MC, MN, ME,
NO, OM, SG, CH, TN, TR, UA, GB, EU, AL, KG / DM/207 214
- [51] Cl. 11-01
- [54] 手鐲
Bracelet
- [73] Harry Winston SA
Chemin du Tourbillon 8,
CH-1228 Plan-les-Ouates,
Switzerland
- [74] SPRUSON & FERGUSON (HONG KONG) LIMITED
5001 Hopewell Centre,
183 Queen's Road East,
Wan Chai, Hong Kong



- [11] 2016719.7M006
- [15] 27-08-2020
- [30] 27-03-2020 / CA, AM, AZ, BZ, BA, GE, LI, MK, MD, MC, MN, ME, NO, OM, SG, CH, TN, TR, UA, GB, EU, AL, KG / DM/207 214
- [51] Cl. 11-01
- [54] 項鍊
Necklace
- [73] Harry Winston SA
Chemin du Tourbillon 8,
CH-1228 Plan-les-Ouates,
Switzerland
- [74] SPRUSON & FERGUSON (HONG KONG) LIMITED
5001 Hopewell Centre,
183 Queen's Road East,
Wan Chai, Hong Kong



-
- [11] 2016719.7M007
- [15] 27-08-2020
- [30] 27-03-2020 / CA, AM, AZ, BZ, BA, GE, LI, MK, MD, MC, MN, ME, NO, OM, SG, CH, TN, TR, UA, GB, EU, AL, KG / DM/207 214
- [51] Cl. 11-01
- [54] 耳環
Earring
- [73] Harry Winston SA
Chemin du Tourbillon 8,
CH-1228 Plan-les-Ouates,
Switzerland
- [74] SPRUSON & FERGUSON (HONG KONG) LIMITED
5001 Hopewell Centre,
183 Queen's Road East,
Wan Chai, Hong Kong

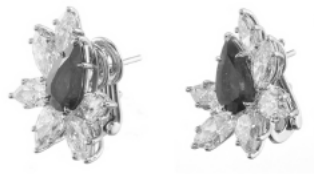

[11] 2016719.7M008

[15] 27-08-2020

[30] 27-03-2020 / CA, AM, AZ, BZ, BA, GE, LI, MK, MD, MC, MN, ME,
NO, OM, SG, CH, TN, TR, UA, GB, EU, AL, KG / DM/207 214

[51] Cl. 11-01

[54] 指環
Ring

[73] Harry Winston SA
Chemin du Tourbillon 8,
CH-1228 Plan-les-Ouates,
Switzerland

[74] SPRUSON & FERGUSON (HONG KONG) LIMITED
5001 Hopewell Centre,
183 Queen's Road East,
Wan Chai, Hong Kong



[11] 2016720.9

[15] 27-08-2020

[30] 28-02-2020 / EU / 007722715-0001

[51] Cl. 3-01

[54] 手袋
Handbag

[73] BALENCIAGA
40 rue de Sèvres,
75007 Paris,
France

[74] DEACONS
5th Floor, Alexandra House,
Central,
Hong Kong



[11] 2016721.1

[15] 27-08-2020

[51] Cl. 14-02

[54] 讀卡器
Card reader

[73] 瑞柏科技控股有限公司
SPECTRA TECHNOLOGIES HOLDINGS
香港九龍
旺角太子道西 193 號
新世紀廣場二期 13 樓 1301-09, 19-20 室

[74] PEGGIE MA
香港九龍
旺角太子道西 193 號
新世紀廣場二期 13 樓 1301-09, 19-20 室



[11] 2016722.3

[15] 27-08-2020

[51] Cl. 13-02

[54] 移動電源

Power bank

[73] DESIGN POOL LIMITED

(Attention : Legal Officer)

2/F, East Town Building,

41 Lockhart Road,

Wanchai, Hong Kong

[74] DESIGN POOL LIMITED (Attention : Legal Officer)

2/F, East Town Building,

41 Lockhart Road,

Wanchai, Hong Kong

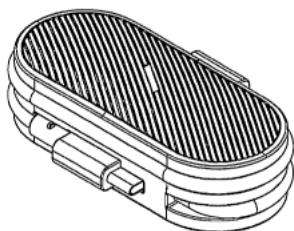

[11] 2016723.5

[15] 27-08-2020

[51] Cl. 10-07

[54] 手錶帶

Watch band

[73] DESIGN POOL LIMITED

(Attention : Legal Officer)

2/F, East Town Building,

41 Lockhart Road,

Wanchai, Hong Kong

[74] DESIGN POOL LIMITED (Attention : Legal Officer)

2/F, East Town Building,

41 Lockhart Road,

Wanchai, Hong Kong

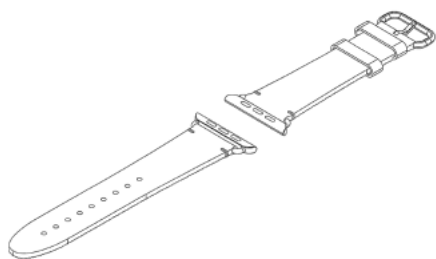

[11] 2016724.7M001

[15] 27-08-2020

[51] Cl. 7-04

[54] 砧板

Chopping board

[73] 百家企業國際集團有限公司

100 Enterprises International Group Co. Ltd.

香港九龍

觀塘海濱道 133 號

萬兆豐中心 15 樓 G 室

[74] 江炳滔律師事務所

香港灣仔

告士打道 160 號

海外信託銀行大廈 19 樓 B 室

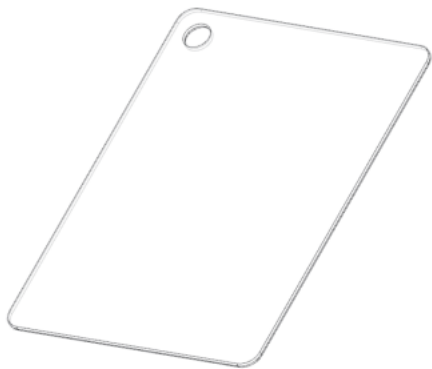

[11] 2016724.7M002

[15] 27-08-2020

[51] Cl. 7-04

[54] 砧板

Chopping board

[73] 百家企業國際集團有限公司

100 Enterprises International Group Co. Ltd.

香港九龍

觀塘海濱道 133 號

萬兆豐中心 15 樓 G 室

[74] 江炳滔律師事務所

香港灣仔

告士打道 160 號

海外信託銀行大廈 19 樓 B 室

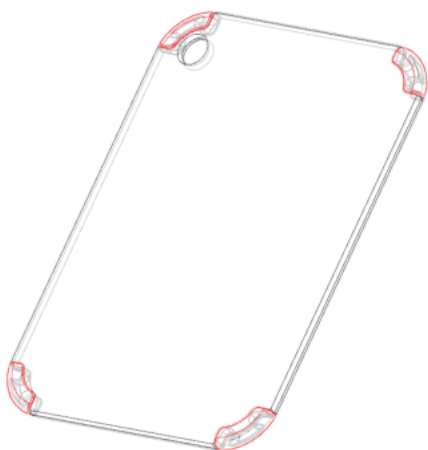

[11] 2016724.7M003

[15] 27-08-2020

[51] Cl. 7-04

- [54] 砧板
Chopping board
- [73] 百家企業國際集團有限公司
100 Enterprises International Group Co. Ltd.
香港九龍
觀塘海濱道 133 號
萬兆豐中心 15 樓 G 室
- [74] 江炳滔律師事務所
香港灣仔
告士打道 160 號
海外信託銀行大廈 19 樓 B 室

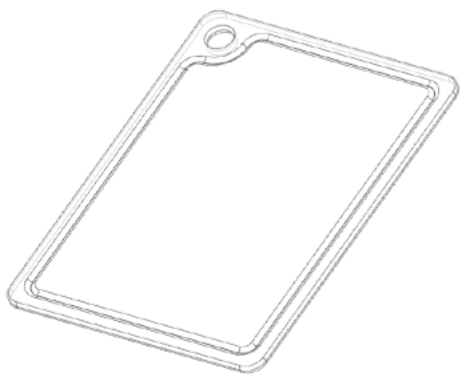

-
- [11] 2016724.7M004
- [15] 27-08-2020
- [51] Cl. 7-04
- [54] 砧板
Chopping board
- [73] 百家企業國際集團有限公司
100 Enterprises International Group Co. Ltd.
香港九龍
觀塘海濱道 133 號
萬兆豐中心 15 樓 G 室
- [74] 江炳滔律師事務所
香港灣仔
告士打道 160 號
海外信託銀行大廈 19 樓 B 室

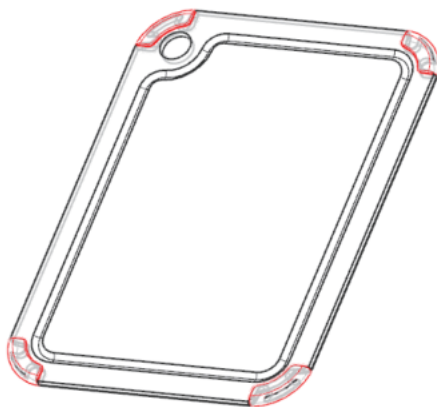

[11] 2016725.0

[15] 27-08-2020

[30] 28-02-2020 / JP / 003895 of 2020

[51] Cl. 23-04

[54] 頸部冷卻裝置

Neck cooling device

[73] Fujitsu General Limited

3-3-17, Suenaga, Takatsu-ku, Kawasaki-shi, Kanagawa, 213-8502,
Japan

[74] EMILY YIP & CO LIMITED

1st Floor, Kingsfield Centre,
18 Shell Street,
Fortress Hill, Hong Kong



[11] 2016727.4

[15] 27-08-2020

[30] 16-07-2020 / EU / 008042964-0001

[51] Cl. 8-08

[54] 鉤環

Carabiners

[73] FLASHBAY ELECTRONICS HONG KONG LTD

Rm A, 26/F., Loong Wan Building,

8 North Point Road,
North Point, Hong Kong

[74] ACCOLADE IP LIMITED
10/F, Fu Fai Comm. Ctr.,
27 Hillier Street,
Sheung Wan, Hong Kong

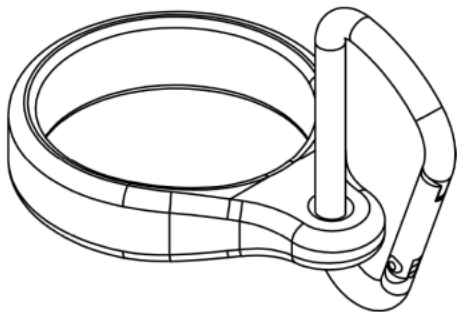

[11] 2016728.6M001

[15] 27-08-2020

[30] 28-02-2020 / IT / 402020000000742

[51] Cl. 3-01

[54] 袋
Bag

[73] VALENTINO S.p.A.
Via Turati, 16/18,
I-20121 Milano,
Italy

[74] BARRON & YOUNG INTELLECTUAL PROPERTY LIMITED
Suite 617, Lakeside 2,
No. 10 Science Park West Avenue,
Hong Kong Science Park, Shatin, N.T.,
Hong Kong

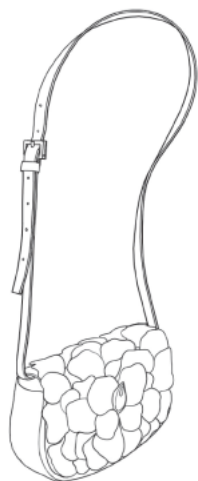

[11] 2016728.6M002

[15] 27-08-2020

[30] 28-02-2020 / IT / 402020000000742

[51] Cl. 3-01

[54] 袋
Bag

[73] VALENTINO S.p.A.
Via Turati, 16/18,
I-20121 Milano,
Italy

[74] BARRON & YOUNG INTELLECTUAL PROPERTY LIMITED
Suite 617, Lakeside 2,
No. 10 Science Park West Avenue,
Hong Kong Science Park, Shatin, N.T.,
Hong Kong

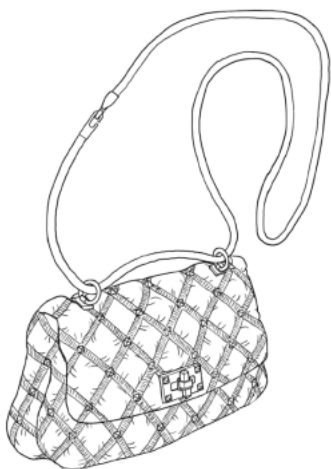

- [11] 2016729.8
[15] 27-08-2020
[30] 28-02-2020 / IT / 402020000000745
[51] Cl. 2-04
[54] 鞋
Shoe
[73] VALENTINO S.p.A.
Via Turati, 16/18,
I-20121 Milano,
Italy
[74] BARRON & YOUNG INTELLECTUAL PROPERTY LIMITED
Suite 617, Lakeside 2,
No. 10 Science Park West Avenue,
Hong Kong Science Park, Shatin, N.T.,
Hong Kong



- [11] 2016730.0
[15] 28-08-2020
[30] 10-03-2020 / DE / 40 2020 100 242.9
[51] Cl. 12-08
[54] 汽車
Motor vehicle
[73] VOLKSWAGEN AKTIENGESELLSCHAFT
Berliner Ring 2,
38440 Wolfsburg,
Germany
[74] CHINA PATENT AGENT (HONG KONG) LIMITED
22/F, Great Eagle Centre,
23 Harbour Road,
Wanchai, Hong Kong



[11] 2016731.2

[15] 28-08-2020

[30] 10-03-2020 / DE / 40 2020 100 242.9

[51] Cl. 21-01

[54] 玩具車

Toy vehicle

[73] VOLKSWAGEN AKTIENGESELLSCHAFT

Berliner Ring 2,

38440 Wolfsburg,

Germany

[74] CHINA PATENT AGENT (HONG KONG) LIMITED

22/F, Great Eagle Centre,

23 Harbour Road,

Wanchai, Hong Kong



[11] 2016732.4

[15] 28-08-2020

[51] Cl. 10-07

[54] 手錶玻璃

Watch glass

[73] 西鐵城時計株式會社

CITIZEN WATCH CO., LTD.

1-12, Tanashicho 6-chome, Nishitokyo-shi,

Tokyo 188-8511,

Japan

- [74] WILKINSON & GRIST
6th Floor, Prince's Building,
Chater Road,
Hong Kong

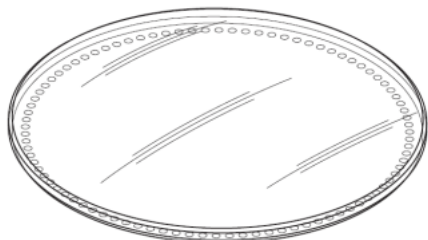

-
- [11] 2016733.6
[15] 28-08-2020
[30] 18-06-2020 / NO, CH, GB, US, EU, IS / WIPO95734
[51] Cl. 23-04
[54] 除濕機
Dehumidifier
[73] 美高(英國)有限公司
MEACO (U.K.) LIMITED
Meaco House, Parklands,
Guildford, GU2 9JX,
United Kingdom
[74] PANAWELL (HONG KONG) LIMITED
Unit C, 19/F., Gold Union Comm. Bldg.,
70-72 Connaught Rd West,
Western, Hong Kong

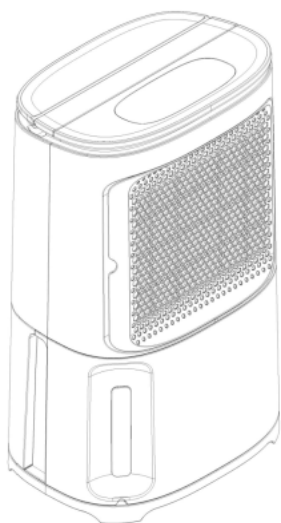

- [11] 2016734.8
[15] 28-08-2020
[30] 18-06-2020 / NO, CH, US, EU, IS / WIPO95734
[51] Cl. 23-04
[54] 除濕機
Dehumidifier
[73] 美高(英國)有限公司
MEACO (U.K.) LIMITED
Meaco House, Parklands,
Guildford, GU2 9JX,
United Kingdom
[74] PANAWELL (HONG KONG) LIMITED
Unit C, 19/F., Gold Union Comm. Bldg.,
70-72 Connaught Rd West,
Western, Hong Kong



-
- [11] 2016735.1
[15] 28-08-2020
[30] 18-06-2020 / NO, CH, GB, US, EU, IS / WIPO95734
[51] Cl. 23-04
[54] 控制面板
Control panel
[73] 美高(英國)有限公司
MEACO (U.K.) LIMITED
Meaco House, Parklands,
Guildford, GU2 9JX,
United Kingdom
[74] PANAWELL (HONG KONG) LIMITED
Unit C, 19/F., Gold Union Comm. Bldg.,

70-72 Connaught Rd West,
Western, Hong Kong

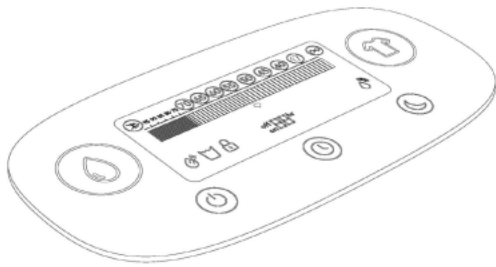

[11] 2016736.3

[15] 28-08-2020

[30] 18-06-2020 / WO / WIPO95734

[51] Cl. 23-04

[54] 除濕機的控制面板

Control panel of dehumidifier

[73] 美高(英國)有限公司

MEACO (U.K.) LIMITED

Meaco House, Parklands,

Guildford, GU2 9JX,

United Kingdom

[74] PANAWELL (HONG KONG) LIMITED

Unit C, 19/F., Gold Union Comm. Bldg.,

70-72 Connaught Rd West,

Western, Hong Kong

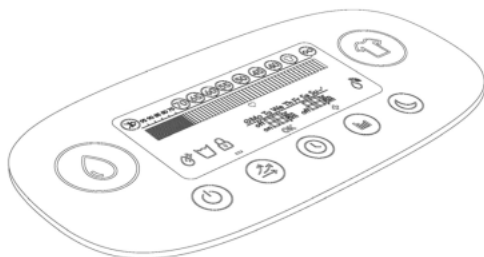

[11] 2016737.5

[15] 28-08-2020

[51] Cl. 29-02

[54] 可重用口罩

Reusable mask

[73] 源思國際有限公司

MANY THINKS INTERNATIONAL LIMITED

Unit 1008, 10/F, Yu Sung Boon Building,
107-111 Des Voeux Road,
Central, Hong Kong

[74] REG EASY INTELLECTUAL PROPERTY CO., LIMITED
14/F, China Hong Kong Tower,
8 Hennessy Road,
Wan Chai, Hong Kong

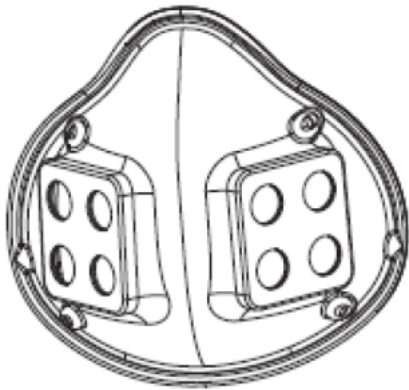

[11] 2016739.9

[15] 28-08-2020

[30] 06-03-2020 / AU / 202011402

[51] Cl. 9-01

[54] 瓶子
Bottle

[73] The Everleigh Bottling Co Pty Ltd
9/49 Smith Street, Fitzroy,
VIC 3065,
Australia

[74] Wong & Tang Solicitors
2001-2, 2012 & 2310, 20 & 23/F, CC Wu Bldg,
Nos. 302-308 Hennessy Road,
Wan Chai, Hong Kong



[11] 2016740.1

[15] 28-08-2020

[30] 06-03-2020 / AU / 202011403

[51] Cl. 9-01

[54] 瓶子

Bottle

[73] The Everleigh Bottling Co Pty Ltd

9/49 Smith Street, Fitzroy,

VIC 3065,

Australia

[74] Wong & Tang Solicitors

2001-2, 2012 & 2310, 20 & 23/F, CC Wu Bldg,

Nos. 302-308 Hennessy Road,

Wan Chai, Hong Kong



[11] 2016741.3

[15] 28-08-2020

[30] 06-03-2020 / AU / 202011404

[51] Cl. 9-01

[54] 瓶子

Bottle

[73] The Everleigh Bottling Co Pty Ltd

9/49 Smith Street, Fitzroy,

VIC 3065,

Australia

[74] Wong & Tang Solicitors

2001-2, 2012 & 2310, 20 & 23/F, CC Wu Bldg,

Nos. 302-308 Hennessy Road,

Wan Chai, Hong Kong

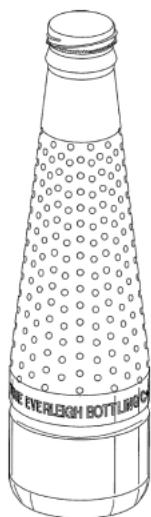

[11] 2016742.5

[15] 28-08-2020

[30] 06-03-2020 / AU / 202011405

[51] Cl. 9-01

[54] 瓶子

Bottle

[73] The Everleigh Bottling Co Pty Ltd

9/49 Smith Street, Fitzroy,

VIC 3065,

Australia

[74] Wong & Tang Solicitors

2001-2, 2012 & 2310, 20 & 23/F, CC Wu Bldg,

Nos. 302-308 Hennessy Road,

Wan Chai, Hong Kong

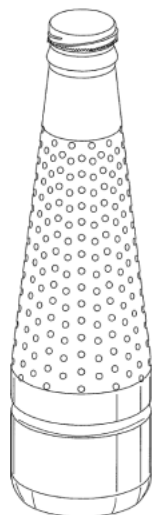

[11] 2016743.7

[15] 28-08-2020

[51] Cl. 25-01

[54] 金屬製盲導標示
Metal tactile marker

[73] 加藍誘導標示有限公司
香港北角
英皇道 89 號
桂洪集團中心 2802 室

[74] 加藍誘導標示有限公司
香港北角
英皇道 89 號
桂洪集團中心 2802 室



[11] 2016746.4

[15] 31-08-2020

[51] Cl. 9-01

[54] 容器

Container

[73] AXXZIA 股份有限公司

AXXZIA INC.

6-3-1 Nishi-Shinjuku,

Shinjuku-ku, Tokyo,

Japan

[74] CLT PATENT & TRADEMARK (H.K.) LIMITED

Unit 09, 34/F., Office Tower, Convention Plaza,

No. 1 Harbour Road,

Wanchai, Hong Kong



[11] 2016749.0M001

[15] 31-08-2020

[30] 08-07-2020 / EU / 008034540-0001

[51] Cl. 10-02

[54] 手錶的一部份

Part of watches

[73] Audemars Piguet (Marketing) SA

Route de France 16,

1348 Le Brassus,

Switzerland

[74] FAIRBAIRN CATLEY LOW & KONG

23/F, Shui On Centre,

6-8 Harbour Road,

Wanchai, Hong Kong



[11] 2016749.0M002

[15] 31-08-2020

[30] 08-07-2020 / EU / 008034540-0002

[51] Cl. 10-02

[54] 手錶的一部份

Part of watches

[73] Audemars Piguet (Marketing) SA

Route de France 16,

1348 Le Brassus,

Switzerland

[74] FAIRBAIRN CATLEY LOW & KONG

23/F, Shui On Centre,

6-8 Harbour Road,

Wanchai, Hong Kong



[11] 2016749.0M003

[15] 31-08-2020

[30] 08-07-2020 / EU / 008034540-0003

[51] Cl. 10-02

[54] 手錶的一部份

Part of watches

[73] Audemars Piguet (Marketing) SA

Route de France 16,
1348 Le Brassus,
Switzerland

[74] FAIRBAIRN CATLEY LOW & KONG

23/F, Shui On Centre,
6-8 Harbour Road,
Wanchai, Hong Kong



[11] 2016750.2

[15] 31-08-2020

[51] Cl. 10-07

[54] 錶盤

Watch dial

[73] Audemars Piguet (Marketing) SA

Route de France 16,
1348 Le Brassus,
Switzerland

[74] FAIRBAIRN CATLEY LOW & KONG

23/F, Shui On Centre,
6-8 Harbour Road,
Wanchai, Hong Kong

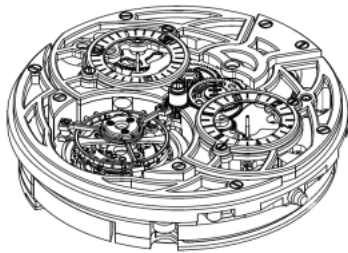

[11] 2016751.4

[15] 31-08-2020

[51] Cl. 7-01

[54] 染色式樣竹製盤

Dyed patterned bamboo tray

[73] 李淑貞

Lee Suk Ching

Room 2305, Mei Lai House,

Mei Tin Estate, Tai Wai,

Hong Kong

[74] ACCOLADE IP LIMITED

10/F, Fu Fai Comm. Ctr.,

27 Hillier Street,

Sheung Wan, Hong Kong



[11] 2016752.6M001

[15] 01-09-2020

[51] Cl. 3-01

[54] 行李箱

Luggage

[73] 新秀麗 IP 控股有限責任公司

Samsonite IP Holdings S.à r.l.

13-15 avenue de la Liberté,

L-1931, Luxembourg,

Luxembourg

[74] WILKINSON & GRIST

6th Floor, Prince's Building,

Chater Road,

Hong Kong

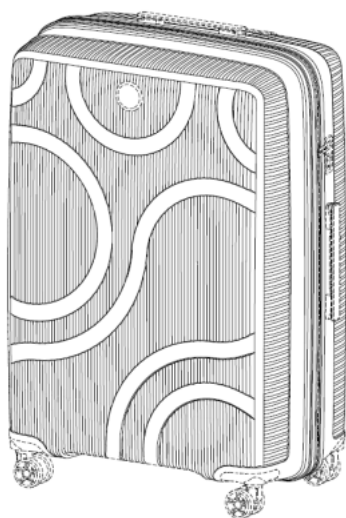

[11] 2016752.6M002

[15] 01-09-2020

[51] Cl. 3-01

[54] 行李箱

Luggage

[73] 新秀麗 IP 控股有限責任公司

Samsonite IP Holdings S.à r.l.

13-15 avenue de la Liberté,

L-1931, Luxembourg,

Luxembourg

[74] WILKINSON & GRIST

6th Floor, Prince's Building,

Chater Road,

Hong Kong

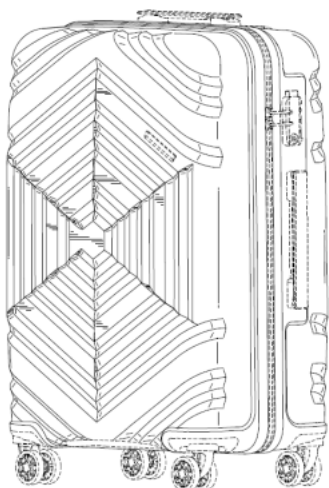

[11] 2016752.6M003

[15] 01-09-2020

[30] 20-03-2020 / EU / 007762786-0002

[51] Cl. 3-01

[54] 行李箱

Luggage

[73] 新秀麗 IP 控股有限責任公司

Samsonite IP Holdings S.à r.l.

13-15 avenue de la Liberté,

L-1931, Luxembourg,

Luxembourg

[74] WILKINSON & GRIST

6th Floor, Prince's Building,

Chater Road,

Hong Kong

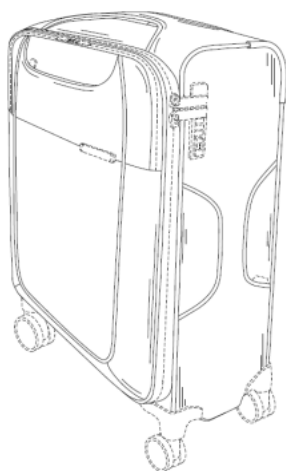

- [11] 2016754.0
[15] 02-09-2020
[51] Cl. 7-02
[54] 電蒸爐
Electric food steamer
[73] 新發電器製品(國際)有限公司
香港新界
屯門杯渡路76號
屯門工業中心E座一字樓二號室
[74] 新發電器製品(國際)有限公司
香港新界
屯門杯渡路76號
屯門工業中心E座一字樓二號室

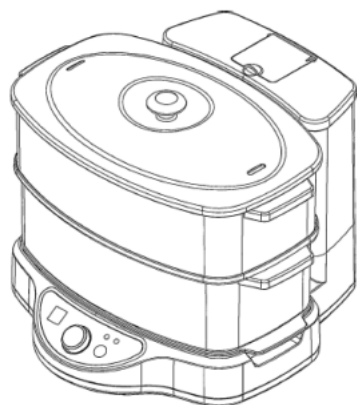

-
- [11] 2016756.5
[15] 02-09-2020
[30] 04-03-2020 / FR / 2020-1092
[51] Cl. 3-01
[54] 袋
Bag
[73] LOUIS VUITTON MALLETIER
2 rue du Pont-Neuf,
75001 Paris,
France
[74] BAKER & MCKENZIE
14th Floor, One Taikoo Place,
979 King's Road,
Quarry Bay, Hong Kong

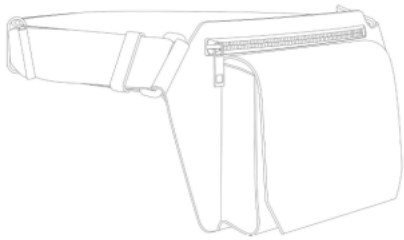

[11] 2016758.9

[15] 02-09-2020

[30] 03-03-2020 / FR / 2020-1062

[51] Cl. 3-01

[54] 袋
Bag

[73] LOUIS VUITTON MALLETIER
2 rue du Pont-Neuf,
75001 Paris,
France

[74] BAKER & MCKENZIE
14th Floor, One Taikoo Place,
979 King's Road,
Quarry Bay, Hong Kong



[11] 2016759.1

[15] 02-09-2020

[51] Cl. 19-08

[54] 包裝標籤
Packaging label

[73] 三正食品（香港）有限公司
SAN ZHENG FOODS (HONG KONG) CO., LTD
香港九龍城
新蒲崗大有街 34 號
新科技大廈 1711 室

[74] 李亦群
香港九龍城
土瓜灣新馬頭街 38 號
翔龍灣 2 座 31 樓 E 室



[11] 2016760.3

[15] 02-09-2020

[51] Cl. 19-08

[54] 包裝標籤
Packaging label

[73] 三正食品（香港）有限公司
SAN ZHENG FOODS (HONG KONG) CO., LTD
香港九龍城
新蒲崗大有街 34 號
新科技廣場 1711 室

[74] 李亦群
香港九龍城
土瓜灣新馬頭街 38 號
翔龍灣 2 座 31 樓 E 室



[11] 2016762.7

[15] 02-09-2020

[51] Cl. 29-02

[54] 口罩
Mask

[73] Ip, Paul Kung Ching
Workshop C, 8/F, Startex Industrial Building,
No. 14 Tai Yau Street,
San Po Kong, Hong Kong

[74] Ample Corporate Services Limited
Unit A, 17/F, Great Smart Tower,
230 Wanchai Road,
Wanchai, Hong Kong

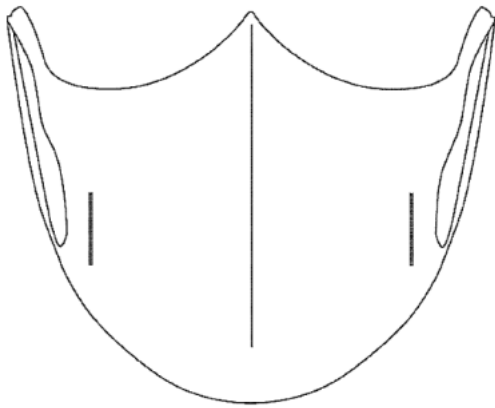

[11] 2016763.9

[15] 02-09-2020

[51] Cl. 25-02

[54] 塑膠欄河
Plastic barrier

[73] 順路交通科技(廣東)股份有限公司
Shunlu Traffic Technology (Guangdong) Co., Limited
Room 02-04, 3A Floor, 3327 Kaichuang Avenue, Huangpu District,
Guangzhou,
China

[74] HONG KONG INTELLECTUAL PROPERTY ADVISORY SERVICE LIMITED
Unit 1701, 17/F., Ew International Tower,
120 Texaco Road,
Tsuen Wan, New Territories, Hong Kong

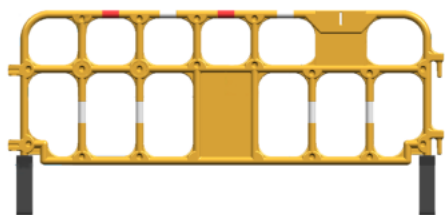

[11] 2016765.4

[15] 03-09-2020

[30] 04-03-2020 / EU / 007732227

[51] Cl. 5-06

[54] 人造或天然材料之片材

Sheet of artificial or natural material

[73] Salvatore Ferragamo S.p.A.

Via dei Tornabuoni 2,

50123 Firenze,

Italy

[74] GALLANT

5/F Jardine House,

1 Connaught Place,

Central, Hong Kong



[11] 2016767.8

[15] 04-09-2020

[51] Cl. 21-01

[54] 毛公仔

Plush toy

[73] GAPSK Limited
香港旺角
彌敦道 580A-F 號
周大福商業中心 16 樓 01 室

[74] GAPSK Limited
香港旺角
彌敦道 580A-F 號
周大福商業中心 16 樓 01 室



[11] 2016768.0

[15] 04-09-2020

[51] Cl. 15-99

[54] 機器人移動平台
Robotic mobile platform

[73] 奧馬迪機械人有限公司
O-Matic Intelligent Robot Limited
香港新界
沙田香港科學園科技大道西 19 號
19W 大樓 2 樓 227 室

[74] 奧馬迪機器人有限公司
香港新界
沙田香港科學園科技大道西 19 號
19W 大樓 2 樓 227 室

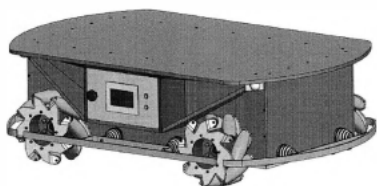

[11] 2016769.2M001

[15] 04-09-2020

[30] 06-03-2020 / US / 29/726,991

[51] Cl. 16-06

[54] 用於眼鏡的水平佈置鉚釘

Horizontal rivets for eyeglasses

[73] JAND, Inc.

233 Spring Street, 6th Floor East,

New York, NY 10013,

United States

[74] HNC INNOVATION LIMITED

Units 1205-1208, Cyberport 2,

No. 100 Cyberport Road,

Hong Kong



[11] 2016769.2M002

[15] 04-09-2020

[30] 06-03-2020 / US / 29/726,991

[51] Cl. 16-06

[54] 用於眼鏡的水平佈置鉚釘

Horizontal rivets for eyeglasses

[73] JAND, Inc.

233 Spring Street, 6th Floor East,

New York, NY 10013,

United States

[74] HNC INNOVATION LIMITED

Units 1205-1208, Cyberport 2,

No. 100 Cyberport Road,

Hong Kong



[11] 2016769.2M003

[15] 04-09-2020

[30] 06-03-2020 / US / 29/726,991

[51] Cl. 16-06

[54] 用於眼鏡的水平佈置鉚釘

Horizontal rivets for eyeglasses

[73] JAND, Inc.

233 Spring Street, 6th Floor East,
New York, NY 10013,
United States

[74] HNC INNOVATION LIMITED

Units 1205-1208, Cyberport 2,
No. 100 Cyberport Road,
Hong Kong



[11] 2016769.2M004

[15] 04-09-2020

[30] 06-03-2020 / US / 29/726,991

[51] Cl. 16-06

[54] 用於眼鏡的水平佈置鉚釘

Horizontal rivets for eyeglasses

[73] JAND, Inc.

233 Spring Street, 6th Floor East,
New York, NY 10013,
United States

[74] HNC INNOVATION LIMITED

Units 1205-1208, Cyberport 2,

No. 100 Cyberport Road,
Hong Kong



[11] 2016770.4M001

[15] 04-09-2020

[30] 06-03-2020 / US / 29/726,990

[51] Cl. 16-06

[54] 用於眼鏡的垂直佈置鉚釘
Vertical rivets for eyeglasses

[73] JAND, Inc.
233 Spring Street, 6th Floor East,
New York, NY 10013,
United States

[74] HNC INNOVATION LIMITED
Units 1205-1208, Cyberport 2,
No. 100 Cyberport Road,
Hong Kong



[11] 2016770.4M002

[15] 04-09-2020

[30] 06-03-2020 / US / 29/726,990

[51] Cl. 16-06

[54] 用於眼鏡的垂直佈置鉚釘
Vertical rivets for eyeglasses

[73] JAND, Inc.
233 Spring Street, 6th Floor East,
New York, NY 10013,
United States

- [74] HNC INNOVATION LIMITED
Units 1205-1208, Cyberport 2,
No. 100 Cyberport Road,
Hong Kong



-
- [11] 2016770.4M003
[15] 04-09-2020
[30] 06-03-2020 / US / 29/726,990
[51] Cl. 16-06
[54] 用於眼鏡的垂直佈置鉚釘
Vertical rivets for eyeglasses
[73] JAND, Inc.
233 Spring Street, 6th Floor East,
New York, NY 10013,
United States
[74] HNC INNOVATION LIMITED
Units 1205-1208, Cyberport 2,
No. 100 Cyberport Road,
Hong Kong



-
- [11] 2016770.4M004
[15] 04-09-2020
[30] 06-03-2020 / US / 29/726,990
[51] Cl. 16-06
[54] 用於眼鏡的垂直佈置鉚釘
Vertical rivets for eyeglasses
[73] JAND, Inc.
233 Spring Street, 6th Floor East,

New York, NY 10013,
United States

[74] HNC INNOVATION LIMITED
Units 1205-1208, Cyberport 2,
No. 100 Cyberport Road,
Hong Kong



[11] 2016771.6M001

[15] 04-09-2020

[30] 06-03-2020 / US / 29/727,000

[51] Cl. 16-06

[54] 用於眼鏡的鉸鏈

Hinge for eyeglasses

[73] JAND, Inc.

233 Spring Street, 6th Floor East,
New York, NY 10013,
United States

[74] HNC INNOVATION LIMITED

Units 1205-1208, Cyberport 2,
No. 100 Cyberport Road,
Hong Kong

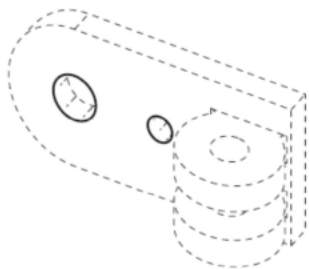

[11] 2016771.6M002

[15] 04-09-2020

[30] 06-03-2020 / US / 29/727,000

[51] Cl. 16-06

[54] 用於眼鏡的鉸鏈

Hinge for eyeglasses

[73] JAND, Inc.

233 Spring Street, 6th Floor East,

New York, NY 10013,

United States

[74] HNC INNOVATION LIMITED

Units 1205-1208, Cyberport 2,

No. 100 Cyberport Road,

Hong Kong

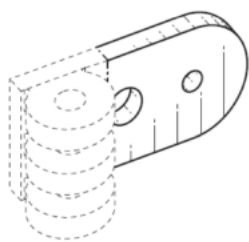

[11] 2016772.8M001

[15] 04-09-2020

[30] 06-03-2020 / US / 29/726,995

[51] Cl. 16-06

[54] 用於眼鏡的鉸鏈

Hinge for eyeglasses

[73] JAND, Inc.

233 Spring Street, 6th Floor East,

New York, NY 10013,

United States

[74] HNC INNOVATION LIMITED

Units 1205-1208, Cyberport 2,

No. 100 Cyberport Road,

Hong Kong

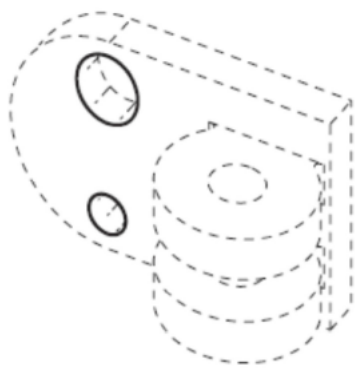

[11] 2016772.8M002

[15] 04-09-2020

[30] 06-03-2020 / US / 29/726,995

[51] Cl. 16-06

[54] 用於眼鏡的鉸鏈

Hinge for eyeglasses

[73] JAND, Inc.

233 Spring Street, 6th Floor East,
New York, NY 10013,
United States

[74] HNC INNOVATION LIMITED

Units 1205-1208, Cyberport 2,
No. 100 Cyberport Road,
Hong Kong

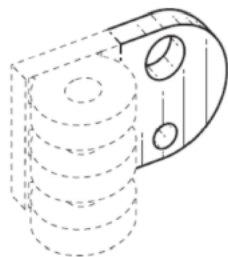

[11] 2016773.0

[15] 04-09-2020

[51] Cl. 2-07

[54] 扁平盒形扣
Flat box shaped buckle

[73] 廣州市天豐珠寶有限公司
Guangzhou TinFung Jewelry Limited
中國內地
廣州市番禺區沙頭街銀建路 34 號二樓

[74] RIGHT IP LIMITED
香港
木星街 9 號
永昇中心 2002

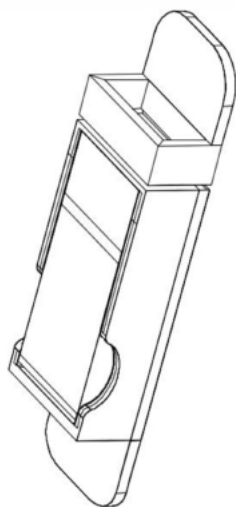

[11] 2016774.2

[15] 04-09-2020

[51] Cl. 2-07

[54] 可鑲嵌寶石的飾品扣
Accessories buckle for gemstones setting

[73] 廣州市天豐珠寶有限公司
Guangzhou TinFung Jewelry Limited
中國內地
廣州市番禺區沙頭街銀建路 34 號二樓

[74] RIGHT IP LIMITED
香港
木星街 9 號
永昇中心 2002

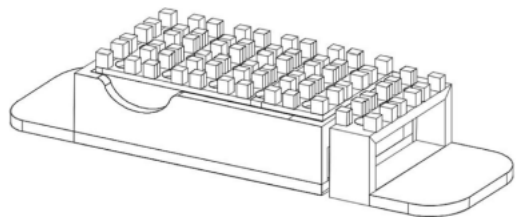

[11] 2016775.5

[15] 04-09-2020

[51] Cl. 9-03

[54] 碟形容器

Disc shaped container

[73] Sino Scots Trading HK Limited

Rm 1102, Tsui Wo House,

Tai Wo Estate,

Hong Kong

[74] Sino Scots Trading HK Limited

Rm 1102, Tsui Wo House,

Tai Wo Estate,

Hong Kong



[11] 2016776.7

[15] 04-09-2020

[30] 16-06-2020 / CN / 202030307080.1

[51] Cl. 16-01

[54] 舌象照相機
Tongue camera

[73] 岐黃在線（上海）智能科技有限公司
Bright AI Technology (Shanghai) Co., Ltd.
421 Newton Road, Pudong New District,
Shanghai 201203,
China

[74] FEDERATION OF HONG KONG INDUSTRIES
31/F, Billion Plaza,
8 Cheung Yue Street,
Cheung Sha Wan, Kowloon, Hong Kong



[11] 2016777.9

[15] 04-09-2020

[30] 01-07-2020 / CN / 202030347884.4

[51] Cl. 24-99

[54] 助聽器
Hearing aid

[73] 深圳市韶音科技有限公司
Shenzhen Voxtech Co., Ltd.
中國內地
廣東省深圳市寶安區石岩街道
浪心社區石新社區山城工業區 26 棟廠房一層至四層

[74] 百睿知識產權有限公司
香港新界
沙田香港科學園
科技大道西 10 號浚湖樓 617 室



[11] 2016780.5M001

[15] 07-09-2020

[30] 11-03-2020 / CH / 145227

[51] Cl. 14-99

[54] 用於操作和顯示的面板

Panel for operating and displaying

[73] 因温特奧股份公司

INVENTIO AG

Seestrasse 55,

CH-6052 Hergiswil NW,

Switzerland

[74] MARKS & CLERK

Level 9, Cyberport 1,

100 Cyberport Road,

Pok Fu Lam, Hong Kong

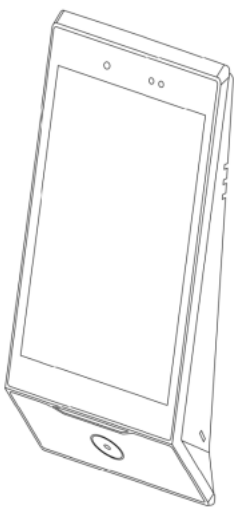

- [11] 2016780.5M002
[15] 07-09-2020
[30] 11-03-2020 / CH / 145227
[51] Cl. 14-99
[54] 用於操作和顯示的面板
Panel for operating and displaying
[73] 因温特奧股份公司
INVENTIO AG
Seestrasse 55,
CH-6052 Hergiswil NW,
Switzerland
[74] MARKS & CLERK
Level 9, Cyberport 1,
100 Cyberport Road,
Pok Fu Lam, Hong Kong

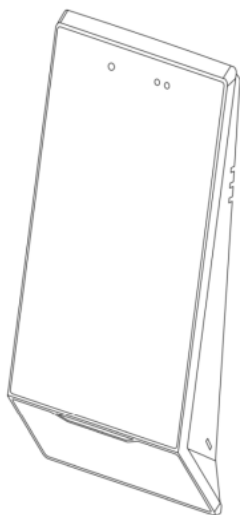

-
- [11] 2016780.5M003
[15] 07-09-2020
[30] 11-03-2020 / CH / 145227
[51] Cl. 14-99
[54] 用於操作和顯示的面板
Panel for operating and displaying
[73] 因温特奧股份公司
INVENTIO AG
Seestrasse 55,
CH-6052 Hergiswil NW,
Switzerland
[74] MARKS & CLERK
Level 9, Cyberport 1,

100 Cyberport Road,
Pok Fu Lam, Hong Kong

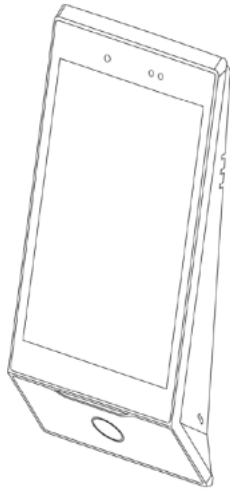

[11] 2016784.3

[15] 07-09-2020

[51] Cl. 21-01

[54] 玩具
Toy

[73] Dragon Rainbow Limited
Level 2, 1 Lam Wah Street,
Kowloon Bay, Kowloon,
Hong Kong

[74] CHINAHONGKONG IP LIMITED
3011, 30/F, Office Tower, Convention Plaza,
1 Harbour Road,
Hong Kong



[11] 2016785.6

[15] 07-09-2020

[51] Cl. 12-08

[54] 巴士
Bus

[73] Dragon Rainbow Limited
Level 2, 1 Lam Wah Street,
Kowloon Bay, Kowloon,
Hong Kong

[74] CHINAHONGKONG IP LIMITED
3011, 30/F, Office Tower, Convention Plaza,
1 Harbour Road,
Hong Kong



[11] 2016788.2

[15] 07-09-2020

[51] Cl. 28-03

[54] 指甲油烘乾器
Nail polish dryer

[73] 周鄂林
中國內地
深圳市南山區西麗街道曙光社區中山園路 1001 號
TCL 科學園區 F5 棟 601、602

[74] 海思國際知識產權有限公司
香港灣仔
皇后大道東 183 號
合和中心 54 樓

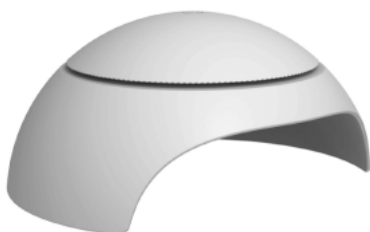

[11] 2016789.4M001

- [15] 07-09-2020
- [30] 10-03-2020 / JP / 004806 of 2020
- [51] Cl. 24-01
- [54] 細胞回收裝置
Cell recovery apparatus
- [73] 樂敦製藥株式會社
ROHTO PHARMACEUTICAL CO., LTD.
1-8-1, Tatsumi-nishi, Ikuno-ku,
Osaka-shi, Osaka,
Japan
- [74] UNION PATENT SERVICE CENTRE
Units E-F, 20th Floor, Neich Tower,
128 Gloucester Road,
Hong Kong

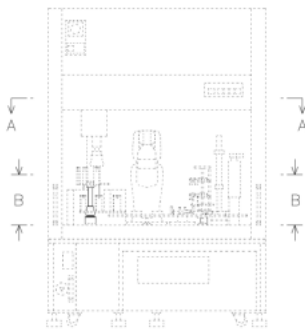

-
- [11] 2016789.4M002
- [15] 07-09-2020
- [30] 10-03-2020 / JP / 004807 of 2020
- [51] Cl. 24-02
- [54] 容器保持座
Container holder
- [73] 樂敦製藥株式會社
ROHTO PHARMACEUTICAL CO., LTD.
1-8-1, Tatsumi-nishi, Ikuno-ku,
Osaka-shi, Osaka,
Japan
- [74] UNION PATENT SERVICE CENTRE
Units E-F, 20th Floor, Neich Tower,
128 Gloucester Road,
Hong Kong

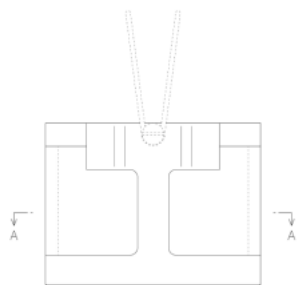

[11] 2016789.4M003

[15] 07-09-2020

[30] 10-03-2020 / JP / 004808 of 2020

[51] C1. 24-02

[54] 容器保持座

Container holder

[73] 樂敦製藥株式會社

ROHTO PHARMACEUTICAL CO., LTD.

1-8-1, Tatsumi-nishi, Ikuno-ku,

Osaka-shi, Osaka,

Japan

[74] UNION PATENT SERVICE CENTRE

Units E-F, 20th Floor, Neich Tower,

128 Gloucester Road,

Hong Kong

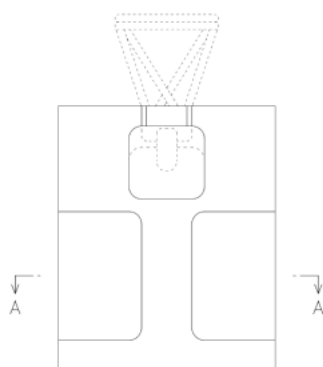

[11] 2016789.4M004

[15] 07-09-2020

[30] 10-03-2020 / JP / 004804 of 2020

[51] C1. 24-01

[54] 細胞回收裝置

Cell recovery apparatus

[73] 樂敦製藥株式會社

ROHTO PHARMACEUTICAL CO., LTD.
1-8-1, Tatsumi-nishi, Ikuno-ku,
Osaka-shi, Osaka,
Japan

[74] UNION PATENT SERVICE CENTRE

Units E-F, 20th Floor, Neich Tower,
128 Gloucester Road,
Hong Kong

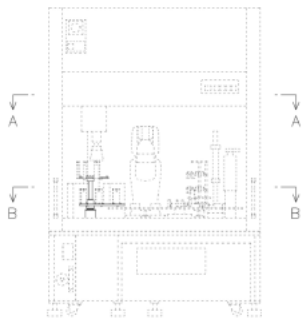

[11] 2016790.6

[15] 07-09-2020

[30] 10-03-2020 / JP / 004805 of 2020

[51] Cl. 15-99

[54] 用於機械臂的保持器

Holding device for robot arm

[73] 樂敦製藥株式會社

ROHTO PHARMACEUTICAL CO., LTD.
1-8-1, Tatsumi-nishi, Ikuno-ku,
Osaka-shi, Osaka,
Japan

[74] UNION PATENT SERVICE CENTRE

Units E-F, 20th Floor, Neich Tower,
128 Gloucester Road,
Hong Kong

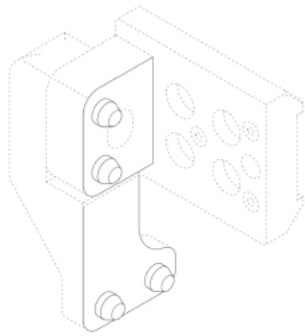

[11] 2016791.8M001

[15] 07-09-2020

[30] 16-03-2020 / CN / 202030087773.4

[51] Cl. 23-07

[54] 座便器蓋板

Toilet lid

[73] 吉博力國際股份公司

Geberit International AG

Schachenstrasse 77,

Ch-8645 Jona,

Switzerland

[74] BARRON & YOUNG INTELLECTUAL PROPERTY LIMITED

Suite 617, Lakeside 2,

No. 10 Science Park West Avenue,

Hong Kong Science Park, Shatin, N.T.,

Hong Kong



[11] 2016791.8M002

[15] 07-09-2020

[30] 16-03-2020 / CN / 202030087773.4

[51] Cl. 23-07

- [54] 座便器蓋板
Toilet lid
- [73] 吉博力國際股份公司
Geberit International AG
Schachenstrasse 77,
Ch-8645 Jona,
Switzerland
- [74] BARRON & YOUNG INTELLECTUAL PROPERTY LIMITED
Suite 617, Lakeside 2,
No. 10 Science Park West Avenue,
Hong Kong Science Park, Shatin, N.T.,
Hong Kong



-
- [11] 2016797.1M001
- [15] 09-09-2020
- [51] Cl. 11-01
- [54] 多功能香薰夾
Multifunctional aroma diffusing clip
- [73] Love Light International Limited
10A, Connaught Harbourfront House,
35-36, Connaught Road West,
Sheung Wan, Hong Kong
- [74] CHINAHONGKONG PATENT LIMITED
3012, 30/F, Office Tower, Convention Plaza,
1 Harbour Road,
Hong Kong



[11] 2016797.1M002

[15] 09-09-2020

[51] Cl. 11-01

[54] 多功能香薰夾

Multifunctional aroma diffusing clip

[73] Love Light International Limited
10A, Connaught Harbourfront House,
35-36, Connaught Road West,
Sheung Wan, Hong Kong

[74] CHINAHONGKONG PATENT LIMITED
3012, 30/F, Office Tower, Convention Plaza,
1 Harbour Road,
Hong Kong



[11] 2016800.9

[15] 09-09-2020

[51] Cl. 7-04

[54] 食物切片裝置

Food slicer

[73] Wong Yan Kwong

Unit 403-404, 4th Floor, Po Lung Centre,
11 Wang Chiu Road,
Kowloon Bay, Kowloon, Hong Kong

[74] LEUNG KIN & CO

9/F Hang Seng Yuen Long Building,
91-93 Castle Peak Road,
Yuen Long, Hong Kong

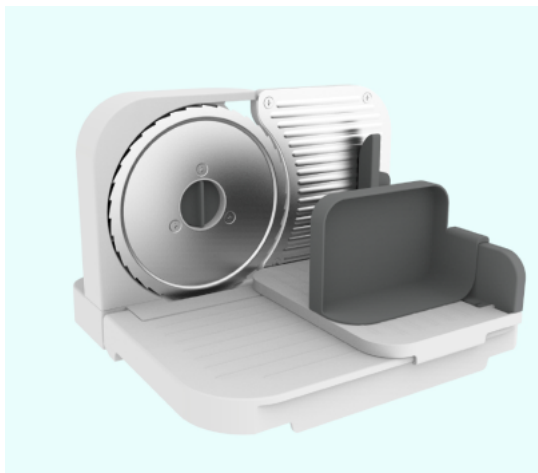

[11] 2016801.1

[15] 09-09-2020

[30] 18-06-2020 / NO, CH, GB, US, EU, IS / WIPO95734

[51] Cl. 23-04

[54] 控制面板

Control panel

[73] 美高(英國)有限公司

MEACO (U.K.) LIMITED
Meaco House, Parklands,
Guildford, GU2 9JX,
United Kingdom

[74] PANAWELL (HONG KONG) LIMITED

Unit C, 19/F., Gold Union Comm. Bldg.,
70-72 Connaught Rd West,
Western, Hong Kong

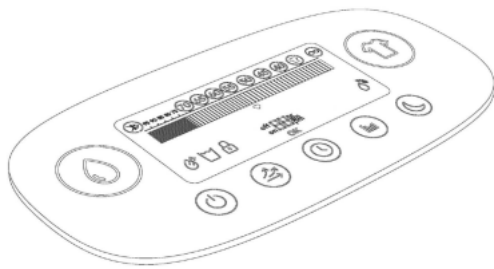

[11] 2016803.5M001

[15] 09-09-2020

[30] 29-07-2020 / GB / 6096531

[51] Cl. 24-02

[54] 測試套件

Test kit

[73] TESTCARD LTD

Unit 6, Betton Business Park,
Racecourse Road, East Ayton,
Scarborough YO13 9HT,
United Kingdom

[74] CHLOE LEE & CO.

1104 Tai Tung Building,
8 Fleming Road,
Wanchai, Hong Kong



[11] 2016803.5M002

[15] 09-09-2020

[30] 29-07-2020 / GB / 6096539

[51] Cl. 24-02

[54] 測試套件

Test kit

[73] TESTCARD LTD

Unit 6, Betton Business Park,
Racecourse Road, East Ayton,
Scarborough YO13 9HT,
United Kingdom

[74] CHLOE LEE & CO.

1104 Tai Tung Building,
8 Fleming Road,
Wanchai, Hong Kong



[11] 2016806.2

[15] 11-09-2020

[30] 13-03-2020 / EU / 007750773

[51] Cl. 12-11

[54] 三輪摩托車

Motor tricycle

[73] PIAGGIO & C. S.p.A.

Viale Rinaldo Piaggio,
25 - 56025 Pontedera (PI),
Italy

[74] CHINA PATENT AGENT (HONG KONG) LIMITED

22/F, Great Eagle Centre,
23 Harbour Road,
Wanchai, Hong Kong



[11] 2016808.6

[15] 11-09-2020

[30] 04-09-2020 / EU / 008159156-0001

[51] Cl. 21-01

[54] 玩具機械人

Toy robot

[73] 銀輝號有限公司

Silverlit Limited

Room 1704, World Trade Centre,

280 Gloucester Road,

Causeway Bay, Hong Kong

[74] Silverlit Limited

Room 1704, World Trade Centre,

280 Gloucester Road,

Causeway Bay, Hong Kong



[11] 2016809.8

[15] 11-09-2020

[51] Cl. 21-01

- [54] 玩具生物
Toy creature
- [73] 銀輝號有限公司
Silverlit Limited
Room 1704, World Trade Centre,
280 Gloucester Road,
Causeway Bay, Hong Kong
- [74] Silverlit Limited
Room 1704, World Trade Centre,
280 Gloucester Road,
Causeway Bay, Hong Kong



-
- [11] 2016814.8
- [15] 11-09-2020
- [30] 13-03-2020 / CN / 202030084024.6
- [51] Cl. 15-05
- [54] 清潔機器人
Cleaning robot
- [73] 北京小米移動軟件有限公司
Beijing Xiaomi Mobile Software Co., Ltd.
中國內地
北京市海澱區西二旗中路 33 號院
6 號樓 8 層 018 號
- [74] 隆天專利商標代理有限公司
香港長沙灣
青山道 485 號
九龍廣場 10 樓 11 室

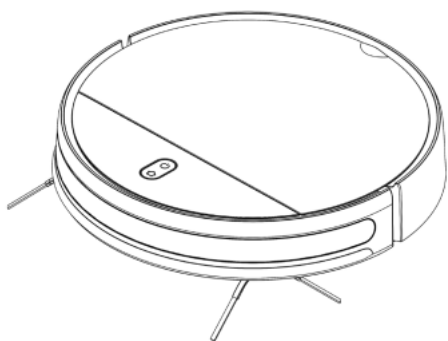

[11] 2016815.1

[15] 11-09-2020

[51] Cl. 7-02

[54] 煤氣爐用頂板

Top plate for gas stove

[73] 能率有限公司

NORITZ CORPORATION

93, Edomachi, Chuo-Ku,

Kobe-Shi, Hyogo 650-0033

Japan

和滿股份有限公司

KABUSHIKI KAISHA HARMAN (HARMAN CO., LTD.)

2-10, Kasugade-minami 3-chome, Konohana-ku,

Osaka

Japan

[74] CHINAHONGKONG PATENT LIMITED

3012, 30/F, Office Tower, Convention Plaza,

1 Harbour Road,

Hong Kong

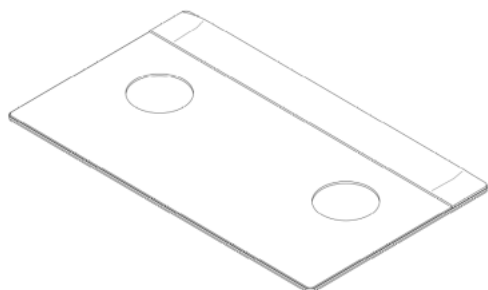



香港特別行政區政府知識產權署外觀設計註冊處

The Government of the Hong Kong Special Administrative Region

Designs Registry, Intellectual Property Department

根據註冊外觀設計條例第 28 條，下列註冊外觀設計因未繳續期費而停止有效。

各組記項按註冊外觀設計停止有效日期及註冊編號先後次序排列。

Registered designs ceased through non-payment of renewal fees under section 28 of the Registered Designs Ordinance. Entries are listed below under their expiry dates.

15-10-2020 - 20-10-2020**15-10-2020**

1502275.1M001

1502250.8

1502275.1M002

1502252.2

20-10-2020**16-10-2020**

1001936.8M001

0502498.1

1001936.8M002

17-10-2020

1001719.8

1001900.2M001

1001900.2M002

18-10-2020

0502522.4M002

0502522.4M003

0502522.4M004

0502523.6

0502526.3

0502529.9

1001909.1M001

1502257.3

1502261.1

19-10-2020

0011524.4M001

0502538.8

1001920.4

1001921.6M001

1001921.6M002

1001922.8

1502265.0

1502271.2

1502272.4

1502274.8



香港特別行政區政府知識產權署外觀設計註冊處

The Government of the Hong Kong Special Administrative Region

Designs Registry, Intellectual Property Department

根據註冊外觀設計規則第 31 條刪除的註冊外觀設計。各組記項按註冊外觀設計刪除日期及註冊編號先後次序排列。

Registered designs removed under section 31 of the Registered Designs Rules. Entries are listed below under their removal dates.

04-12-2020 - 09-12-2020**04-12-2020**

1000677.7
1000679.1M001
1000681.5
1000682.7
1000684.1M001
1000684.1M002
1000684.1M003
1000684.1M004
1500874.9

05-12-2020

1500879.0
1500880.2M001
1500880.2M002
1500880.2M003
1500883.8

06-12-2020

0500810.3
1500884.0
1500885.3
1500886.5M001
1500886.5M002
1500886.5M003

07-12-2020

0500859.6M001
0500859.6M002
0500859.6M003
1000692.8
1000693.0
1000695.5
1000701.9

08-12-2020

0500874.7
0500875.0M004
0500879.8
0500883.6
0500887.5
0500888.7
1000713.4
1000714.6
1500887.7
1500889.1
1500890.3

09-12-2020

0500903.0
1000725.0
1000726.2
1500893.9
1500894.1