

香港知識產權公報

Hong Kong Intellectual Property Journal

2022年2月25日
25 February 2022

目錄 Contents

根據註冊外觀設計條例第 25 條註冊的外觀設計

Designs Registered under section 25 of the Registered Designs Ordinance

按註冊編號排列

Arranged by Registration Number

根據註冊外觀設計條例(第 522 章)公布的其他公告

Other Notices Published under the Registered Designs Ordinance (Cap. 522)

根據註冊外觀設計條例第 28 條，註冊外觀設計因未繳續期費而停止有效

Registered designs ceased through non-payment of renewal fees under section 28 of the Registered Designs Ordinance

根據註冊外觀設計規則第 31 條刪除的註冊外觀設計

Registered designs removed under section 31 of the Registered Designs Rules

以下事項沒有記錄

No Records for the Following Matters

根據註冊外觀設計條例第 30 條放棄的外觀設計的註冊

Surrender of Registration of Design under section 30 of the Registered Designs Ordinance

根據註冊外觀設計規則第 37 條，向處長作出轉介

Reference to Registrar under section 37 of the Registered Designs Rules

根據註冊外觀設計條例第 45 條，撤銷註冊

Revocation of Registration under section 45 of the Registered Designs Ordinance

根據註冊外觀設計規則第 46 條，向法院作出轉介

Reference to Court under section 46 of the Registered Designs Rules

根據註冊外觀設計規則第 63 條對不符合規定之處作出糾正

Rectification of Irregularities under section 63 of the Registered Designs Rules

根據註冊外觀設計條例第 66 條，糾正註冊紀錄冊

Rectification of Register under section 66 of the Registered Designs Ordinance

根據註冊外觀設計條例第 67 條 更正註冊紀錄冊內的錯誤

Correction of errors in Register under section 67 of the Registered Designs Ordinance

根據註冊外觀設計條例第 67 及 76 條，更正註冊紀錄冊內及已提交文件中的錯誤

Correction of Errors in Register and in Filed Documents under sections 67 and 76 of the Registered Designs Ordinance

根據註冊外觀設計條例第 76 條，更正已提交文件中的錯誤

Correction of errors in filed documents under section 76 of the Registered Designs Ordinance

勘誤

Corrigendum

註冊外觀設計公告註釋

Notes on advertisements of registration of designs

方括號表示下列資料：

Square brackets indicate the following data：

[11] 註冊編號 Registration number / 聯合王國註冊編號 United Kingdom registration number

[15] 註冊日期 Registration date / 當作註冊日期 Deemed registration date / 聯合王國註冊日期 United Kingdom registration date

[17] 註冊有效期屆滿日期 Expiry date of the period of registration

[22] 提交日期 Filing date / 當作提交日期 Deemed filing date / 聯合王國提交日期 United Kingdom filing date

[30] 聲稱享有的優先權（提交日期 / 巴黎公約國或世界貿易組織成員 / 申請編號） Priority claimed (filing date / Paris Convention country or WTO member / application number)

[51] 國際外觀設計分類號（洛迦諾分類號） International Classification of designs (Locarno Classification)

[54] 物品 Article

[55] 外觀設計的表述 Representation of the design

[62] 分開前的申請編號及提交日期 Application number before division and filing date

[66] 過往註冊的聯繫外觀設計註冊編號 / 日期 Registration No. / Date of Previous Registration for Association

[72] 設計人 Designer

[73] 擁有人姓名和地址 Name and address of the owner

[74] 代理人 Agent /送達地址 Address for service



香港特別行政區政府知識產權署外觀設計註冊處

The Government of the Hong Kong Special Administrative Region

Designs Registry, Intellectual Property Department

根據註冊外觀設計條例第 25 條註冊的外觀設計

Designs registered under section 25 of the Registered Designs Ordinance

按註冊編號排列

Arranged by Registration Number

[11] 2118563.8M001

[15] 25-08-2021

[30] 25-02-2021 / AU / 202111037

[51] Cl. 4-02

[54] 牙刷

Toothbrush

[73] Dentismile Australia Pty Ltd
903, 279 Wellington Parade S,
East Melbourne, Victoria, 3002,
Australia

[74] RIBEIRO HUI
6/F, Wilson House,
19-27 Wyndham Street,
Central, Hong Kong



[11] 2118563.8M002

[15] 25-08-2021

[30] 25-02-2021 / AU / 202111037

[51] Cl. 4-02

[54] 牙刷頭

Toothbrush head

[73] Dentismile Australia Pty Ltd
903, 279 Wellington Parade S,
East Melbourne, Victoria, 3002,
Australia

[74] RIBEIRO HUI
6/F, Wilson House,
19-27 Wyndham Street,
Central, Hong Kong



[11] 2118563.8M003

[15] 25-08-2021

[30] 25-02-2021 / AU / 202111037

[51] Cl. 4-02

[54] 牙刷柄

Toothbrush handle

[73] Dentismile Australia Pty Ltd
903, 279 Wellington Parade S,
East Melbourne, Victoria, 3002,
Australia

[74] RIBEIRO HUI
6/F, Wilson House,
19-27 Wyndham Street,
Central, Hong Kong



[11] 2118563.8M004

[15] 25-08-2021

[30] 25-02-2021 / AU / 202111037

[51] Cl. 4-02

[54] 牙刷夾

Toothbrush clip

[73] Dentismile Australia Pty Ltd
903, 279 Wellington Parade S,
East Melbourne, Victoria, 3002,
Australia

[74] RIBEIRO HUI
6/F, Wilson House,
19-27 Wyndham Street,
Central, Hong Kong



- [11] 2118674.3
[15] 14-09-2021
[30] 15-03-2021 / CN / 202130138716.9
[51] Cl. 3-01
[54] 耳機盒
Earphone case
[73] 北京小米移動軟件有限公司
BEIJING XIAOMI MOBILE SOFTWARE CO., LTD.
中國內地
北京市海澱區西二旗中路 33 號院
6 號樓 8 層 018 號
[74] 香港派特恩知識產權代理有限公司
香港上環
永樂街 121-125 號
永達商業大廈 10 樓 C 室

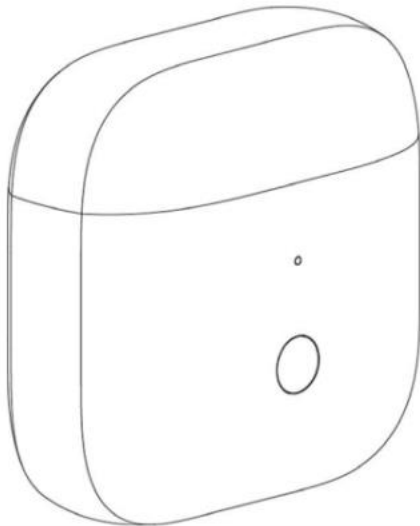

-
- [11] 2118676.8
[15] 14-09-2021
[30] 14-04-2021 / JP / 007868 of 2021
[51] Cl. 21-01
[54] 具有按鍵的玩具
Toy with buttons
[73] Kabushiki Kaisha Bandai (Bandai Co., Ltd.)
4-8, Komagata 1-chome,
Taito-ku, Tokyo,
Japan
[74] SIMMONS & SIMMONS
30th Floor, One Taikoo Place,

979 King's Road,
Hong Kong



-
- [11] 2118689.5
[15] 16-09-2021
[30] 16-03-2021 / CN / 202130141895.1
[51] Cl. 3-01
[54] 耳機盒
Earphone case
[73] 北京小米移動軟件有限公司
BEIJING XIAOMI MOBILE SOFTWARE CO., LTD.
中國內地
北京市海澱區西二旗中路 33 號院
6 號樓 8 層 018 號
[74] 香港派特恩知識產權代理有限公司
香港上環
永樂街 121-125 號
永達商業大廈 10 樓 C 室

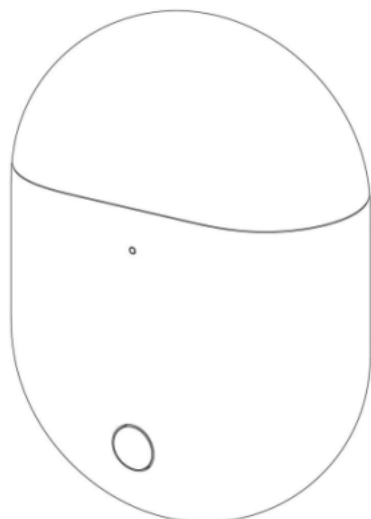

[11] 2118700.0

[15] 16-09-2021

[30] 17-03-2021 / CN / 202130144369.0

[51] Cl. 13-02

[54] 耳機充電盒

Earphone charging case

[73] 北京小米移動軟件有限公司

BEIJING XIAOMI MOBILE SOFTWARE CO., LTD.

中國內地

北京市海澱區西二旗中路 33 號院

6 號樓 8 層 018 號

[74] 香港派特恩知識產權代理有限公司

香港上環

永樂街 121-125 號

永達商業大廈 10 樓 C 室

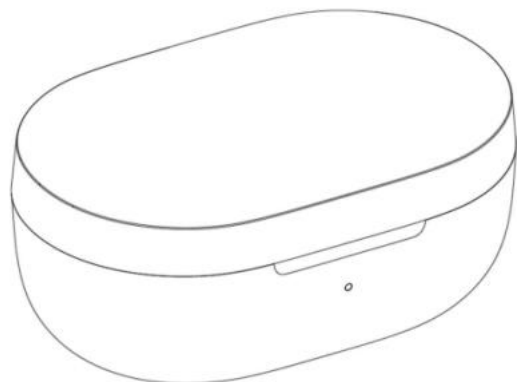

[11] 2118816.6

[15] 11-10-2021

[51] Cl. 11-01

[54] 手鐲

Bracelet

[73] 德利珠寶首飾有限公司

TAK LEI GOLD & JEWELLERY LIMITED

Flat 204, Ning Tai House, Fu Tai Estate,

Tuen Mun, New Territories,

Hong Kong

[74] RAYMOND CHAN SOLICITORS

15B Winsan Tower,

98 Thomson Road,

Wanchai, Hong Kong



[11] 2118817.8

[15] 11-10-2021

[51] Cl. 11-01

[54] 手鐲

Bracelet

[73] 德利珠寶首飾有限公司

TAK LEI GOLD & JEWELLERY LIMITED

Flat 204, Ning Tai House, Fu Tai Estate,

Tuen Mun, New Territories,

Hong Kong

[74] RAYMOND CHAN SOLICITORS

15B Winsan Tower,

98 Thomson Road,

Wanchai, Hong Kong



[11] 2118818.0

[15] 11-10-2021

[51] Cl. 9-03

[54] 啤酒包裝瓶

Beer packaging

[73] 酒譜有限公司

LAB BREWERY LIMITED

香港葵涌

葵喜街 13-29 號

永恆工業大廈 4 樓 5 室

[74] 酒譜有限公司

香港葵涌

葵喜街 13-29 號

永恆工業大廈 4 樓 5 室



[11] 2118859.6M001

[15] 20-10-2021

[30] 11-10-2021 / EU / 008722342

[51] Cl. 29-02

[54] 可拆卸護肩的戰術背心

Tactical vest with removable shoulder protection

[73] PROTECOP

33 boulevard Malesherbes,
75008 Paris,
France

[74] UNION PATENT SERVICE CENTRE

Units E-F, 20th Floor, Neich Tower,
128 Gloucester Road,
Hong Kong



[11] 2118859.6M002

[15] 20-10-2021

[30] 11-10-2021 / EU / 008722342

[51] Cl. 29-02

[54] 可拆卸護肩的戰術背心

Tactical vest with removable shoulder protection

[73] PROTECOP

33 boulevard Malesherbes,
75008 Paris,
France

[74] UNION PATENT SERVICE CENTRE

Units E-F, 20th Floor, Neich Tower,
128 Gloucester Road,
Hong Kong



[11] 2118859.6M003

[15] 20-10-2021

[30] 11-10-2021 / EU / 008722342

[51] Cl. 29-02

[54] 戰術背心

Tactical vest

[73] PROTECOP

33 boulevard Malesherbes,

75008 Paris,

France

[74] UNION PATENT SERVICE CENTRE

Units E-F, 20th Floor, Neich Tower,

128 Gloucester Road,

Hong Kong



- [11] 2118859.6M004
[15] 20-10-2021
[30] 11-10-2021 / EU / 008722342
[51] Cl. 29-02
[54] 戰術背心
Tactical vest
[73] PROTECOP
33 boulevard Malesherbes,
75008 Paris,
France
[74] UNION PATENT SERVICE CENTRE
Units E-F, 20th Floor, Neich Tower,
128 Gloucester Road,
Hong Kong



-
- [11] 2118875.0M001
[15] 22-10-2021
[30] 23-04-2021 / EU / 008515191
[51] Cl. 2-04
[54] 鞋子
Shoe
[73] ROGER VIVIER S.P.A.
Via Filippo Della Valle 1,
I-63811 Sant'Elpidio A Mare (Fermo),
Italy
[74] CHINA PATENT AGENT (HONG KONG) LIMITED
22/F, Great Eagle Centre,
23 Harbour Road,
Wanchai, Hong Kong



[11] 2118875.0M002

[15] 22-10-2021

[30] 23-04-2021 / EU / 008515191

[51] Cl. 2-07

[54] 扣件

Buckle

[73] ROGER VIVIER S.P.A.

Via Filippo Della Valle 1,

I-63811 Sant'Elpidio A Mare (Fermo),

Italy

[74] CHINA PATENT AGENT (HONG KONG) LIMITED

22/F, Great Eagle Centre,

23 Harbour Road,

Wanchai, Hong Kong



[11] 2118875.0M003

[15] 22-10-2021

[30] 23-04-2021 / EU / 008515191

[51] Cl. 2-07

[54] 扣件

Buckle

[73] ROGER VIVIER S.P.A.

Via Filippo Della Valle 1,

I-63811 Sant'Elpidio A Mare (Fermo),
Italy

[74] CHINA PATENT AGENT (HONG KONG) LIMITED
22/F, Great Eagle Centre,
23 Harbour Road,
Wanchai, Hong Kong



[11] 2118875.0M004

[15] 22-10-2021

[30] 23-04-2021 / EU / 008515191

[51] Cl. 2-07

[54] 扣件
Buckle

[73] ROGER VIVIER S.P.A.
Via Filippo Della Valle 1,
I-63811 Sant'Elpidio A Mare (Fermo),
Italy

[74] CHINA PATENT AGENT (HONG KONG) LIMITED
22/F, Great Eagle Centre,
23 Harbour Road,
Wanchai, Hong Kong



[11] 2118911.7

- [15] 01-11-2021
- [30] 07-05-2021 / DE / 40 2021 100 435.1
- [51] Cl. 21-01
- [54] 玩具或比例模型車
Toy or scale model vehicle
- [73] Bayerische Motoren Werke Aktiengesellschaft
Petuelring 130,
80809 Muenchen,
Germany
- [74] HASTINGS & CO
5/F, Gloucester Tower, The Landmark,
11 Pedder Street,
Central, Hong Kong



-
- [11] 2118943.4M001
- [15] 05-11-2021
- [30] 10-05-2021 / EU / 008534531-0001
- [51] Cl. 14-04
- [54] 動態圖形用戶界面
Animated graphical user interface
- [73] Koninklijke Philips N.V.
High Tech Campus 52,
5656 AG Eindhoven,
Netherlands
- [74] Rouse & Co. International (Overseas) Limited
26/F., Tesbury Centre,
28 Queen's Road East,
Hong Kong



[11] 2118943.4M002

[15] 05-11-2021

[30] 10-05-2021 / EU / 008534531-0002

[51] Cl. 14-04

[54] 動態圖形用戶界面

Animated graphical user interface

[73] Koninklijke Philips N.V.

High Tech Campus 52,

5656 AG Eindhoven,

Netherlands

[74] Rouse & Co. International (Overseas) Limited

26/F., Tesbury Centre,

28 Queen's Road East,

Hong Kong



[11] 2118943.4M003

[15] 05-11-2021

[30] 10-05-2021 / EU / 008534531-0003

[51] Cl. 14-04

- [54] 動態圖形用戶界面
Animated graphical user interface
- [73] Koninklijke Philips N.V.
High Tech Campus 52,
5656 AG Eindhoven,
Netherlands
- [74] Rouse & Co. International (Overseas) Limited
26/F., Tesbury Centre,
28 Queen's Road East,
Hong Kong



-
- [11] 2118943.4M004
- [15] 05-11-2021
- [30] 10-05-2021 / EU / 008534531-0004
- [51] Cl. 14-04
- [54] 動態圖形用戶界面
Animated graphical user interface
- [73] Koninklijke Philips N.V.
High Tech Campus 52,
5656 AG Eindhoven,
Netherlands
- [74] Rouse & Co. International (Overseas) Limited
26/F., Tesbury Centre,
28 Queen's Road East,
Hong Kong



-
- [11] 2118943.4M005
[15] 05-11-2021
[30] 10-05-2021 / EU / 008534531-0005
[51] Cl. 14-04
[54] 動態圖形用戶界面
Animated graphical user interface
[73] Koninklijke Philips N.V.
High Tech Campus 52,
5656 AG Eindhoven,
Netherlands
[74] Rouse & Co. International (Overseas) Limited
26/F., Tesbury Centre,
28 Queen's Road East,
Hong Kong



-
- [11] 2118943.4M006
[15] 05-11-2021
[30] 10-05-2021 / EU / 008534531-0006

- [51] Cl. 14-04
- [54] 動態圖形用戶界面
Animated graphical user interface
- [73] Koninklijke Philips N.V.
High Tech Campus 52,
5656 AG Eindhoven,
Netherlands
- [74] Rouse & Co. International (Overseas) Limited
26/F., Tesbury Centre,
28 Queen's Road East,
Hong Kong



-
- [11] 2118943.4M007
- [15] 05-11-2021
- [30] 10-05-2021 / EU / 008534531-0007
- [51] Cl. 14-04
- [54] 動態圖形用戶界面
Animated graphical user interface
- [73] Koninklijke Philips N.V.
High Tech Campus 52,
5656 AG Eindhoven,
Netherlands
- [74] Rouse & Co. International (Overseas) Limited
26/F., Tesbury Centre,
28 Queen's Road East,
Hong Kong



[11] 2118943.4M008

[15] 05-11-2021

[30] 10-05-2021 / EU / 008534531-0008

[51] Cl. 14-04

[54] 動態圖形用戶界面

Animated graphical user interface

[73] Koninklijke Philips N.V.

High Tech Campus 52,

5656 AG Eindhoven,

Netherlands

[74] Rouse & Co. International (Overseas) Limited

26/F., Tesbury Centre,

28 Queen's Road East,

Hong Kong



[11] 2118943.4M009

[15] 05-11-2021

[30] 10-05-2021 / EU / 008534531-0009

[51] Cl. 14-04

- [54] 動態圖形用戶界面
Animated graphical user interface
- [73] Koninklijke Philips N.V.
High Tech Campus 52,
5656 AG Eindhoven,
Netherlands
- [74] Rouse & Co. International (Overseas) Limited
26/F., Tesbury Centre,
28 Queen's Road East,
Hong Kong



-
- [11] 2118943.4M010
- [15] 05-11-2021
- [30] 10-05-2021 / EU / 008534531-0010
- [51] Cl. 14-04
- [54] 動態圖形用戶界面
Animated graphical user interface
- [73] Koninklijke Philips N.V.
High Tech Campus 52,
5656 AG Eindhoven,
Netherlands
- [74] Rouse & Co. International (Overseas) Limited
26/F., Tesbury Centre,
28 Queen's Road East,
Hong Kong



-
- [11] 2118984.0M001
- [15] 16-11-2021
- [30] 17-05-2021 / CH, GB, EU / WIPO104871
- [51] Cl. 9-01
- [54] 瓶
Flacon

[73] Cartier International AG
Hinterbergstrasse 22,
6312 Steinhausen,
Switzerland

[74] DEACONS
5th Floor, Alexandra House,
Central,
Hong Kong

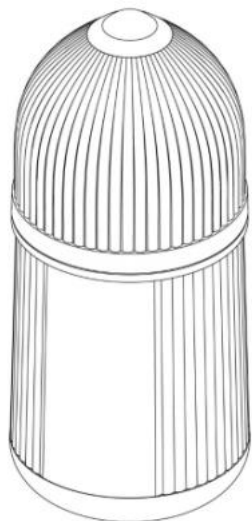

[11] 2118984.0M002

[15] 16-11-2021

[30] 17-05-2021 / CH, GB, EU / WIPO104871

[51] Cl. 9-07

[54] 瓶蓋

Cap for flacon

[73] Cartier International AG
Hinterbergstrasse 22,
6312 Steinhausen,
Switzerland

[74] DEACONS
5th Floor, Alexandra House,
Central,
Hong Kong

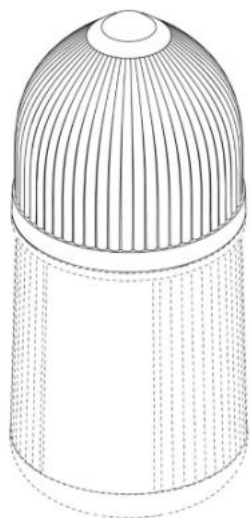

[11] 2118987.7

[15] 17-11-2021

[30] 17-05-2021 / EU / 008543938

[51] Cl. 2-04

[54] 鞋

Footwear

[73] INTERBASIC HOLDING S.R.L.

Strada Settecamini 116,

I-63811 Sant'Elpidio a Mare (FERMO),

Italy

[74] CHINA PATENT AGENT (HONG KONG) LIMITED

22/F, Great Eagle Centre,

23 Harbour Road,

Wanchai, Hong Kong

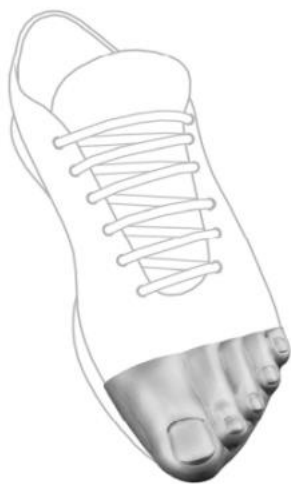

- [11] 2118989.1
[15] 17-11-2021
[30] 17-05-2021 / US / 29/783,949
[51] Cl. 9-01
[54] 容器
Container
[73] ANTIPODEAN PHARMACEUTICALS, INC.
Level 2, 16 Viaduct Harbour Avenue,
Auckland 1140,
New Zealand
[74] INSIGHT (HK) INTELLECTUAL PROPERTY LIMITED
Unit 503, 5/F., Tower 2, Lippo Centre,
89 Queensway,
Admiralty, Hong Kong

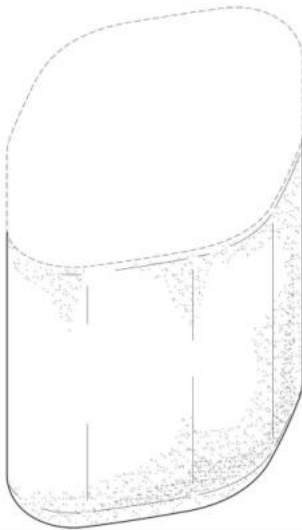

-
- [11] 2118990.3
[15] 17-11-2021
[30] 17-05-2021 / US / 29/783,950
[51] Cl. 9-01
[54] 容器
Container
[73] ANTIPODEAN PHARMACEUTICALS, INC.
Level 2, 16 Viaduct Harbour Avenue,
Auckland 1140,
New Zealand
[74] INSIGHT (HK) INTELLECTUAL PROPERTY LIMITED
Unit 503, 5/F., Tower 2, Lippo Centre,
89 Queensway,
Admiralty, Hong Kong

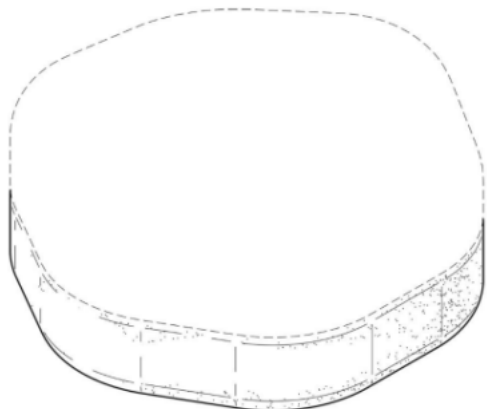

-
- [11] 2119012.1
[15] 24-11-2021
[30] 01-06-2021 / DE / 40 2021 100 497.1
[51] Cl. 21-01
[54] 玩具或比例模型車
Toy or scale model vehicle
[73] Bayerische Motoren Werke Aktiengesellschaft
Petuelring 130,
80809 Muenchen,
Germany
[74] HASTINGS & CO
5/F, Gloucester Tower, The Landmark,
11 Pedder Street,
Central, Hong Kong



-
- [11] 2119034.7
[15] 29-11-2021
[30] 25-06-2021 / US / 29/796,710
[51] Cl. 20-02
[54] 展示支架
Display stand
[73] 蘋果公司
APPLE INC.

One Apple Park Way, Cupertino,
California 95014
United States of America

[74] CLT PATENT & TRADEMARK (H.K.) LIMITED
Unit 09, 34/F., Office Tower,
Convention Plaza, 1 Harbour Road,
Wanchai, Hong Kong

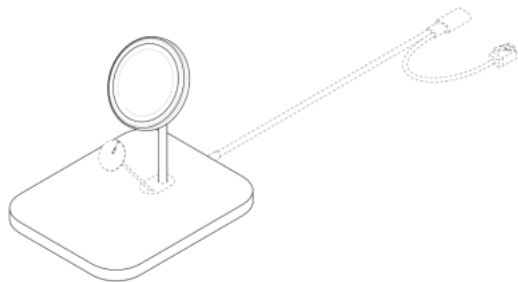

[11] 2119071.5M001

[15] 02-12-2021

[30] 26-08-2021 / AU / 202115086

[51] Cl. 8-08

[54] 管口法蘭盤
Blanking flange

[73] Hynds Limited
7 Arwen Place,
Auckland 2013,
New Zealand

[74] SPRUSON & FERGUSON (HONG KONG) LIMITED
5001 Hopewell Centre,
183 Queen's Road East,
Wan Chai, Hong Kong

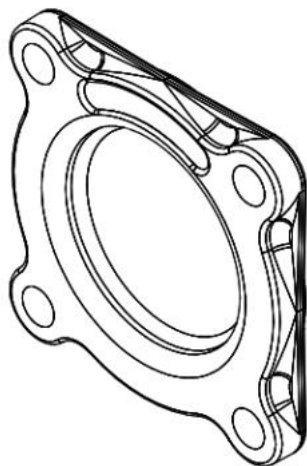

[11] 2119071.5M002

[15] 02-12-2021

[30] 26-08-2021 / AU / 202115087

[51] Cl. 8-08

[54] 管口法蘭盤

Blanking flange

[73] Hynds Limited

7 Arwen Place,

Auckland 2013,

New Zealand

[74] SPRUSON & FERGUSON (HONG KONG) LIMITED

5001 Hopewell Centre,

183 Queen's Road East,

Wan Chai, Hong Kong

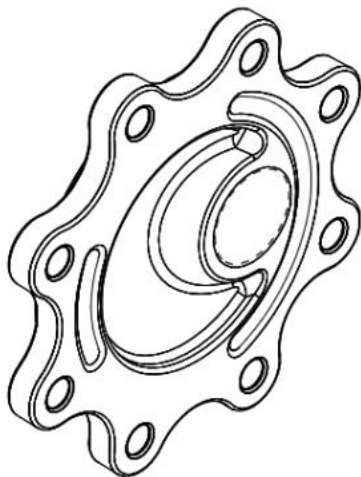

[11] 2119071.5M003

[15] 02-12-2021

[30] 26-08-2021 / AU / 202115088

[51] Cl. 8-08

[54] 管口法蘭盤

Blanking flange

[73] Hynds Limited

7 Arwen Place,

Auckland 2013,

New Zealand

[74] SPRUSON & FERGUSON (HONG KONG) LIMITED

5001 Hopewell Centre,

183 Queen's Road East,

Wan Chai, Hong Kong

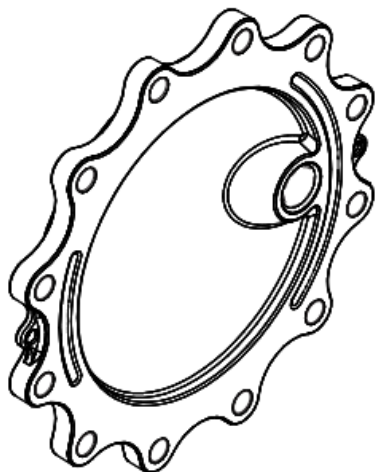

[11] 2119159.2

[15] 15-12-2021

[30] 16-06-2021 / US / 29/795,021

[51] Cl. 10-07

[54] 反寫傳感器盒

Retrographic sensor cartridge

[73] GELSIGHT, INC.

179 Bear Hill Road, UNIT #202,

Waltham, MA 02451,

United States of America

[74] CHINA PATENT AGENT (HONG KONG) LIMITED

22/F, Great Eagle Centre,

23 Harbour Road, Wanchai,

Hong Kong.

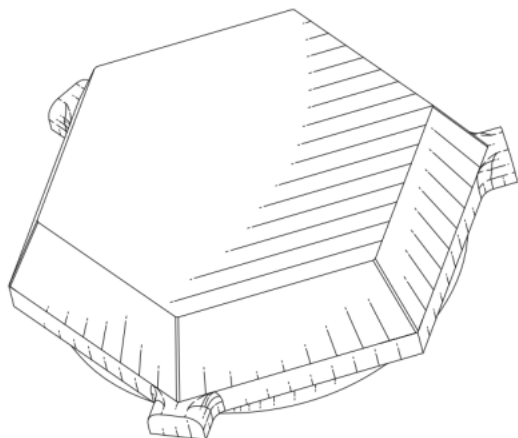

[11] 2119169.3

- [15] 16-12-2021
[30] 26-10-2021 / KR / 30-2021-0050638
[51] Cl. 4-02
[54] 電子牙刷刷頭
Head of electric toothbrush
[73] 株式會社普若希醫療保健
Proxihealthcare Inc.
大韓民國
蔚山廣域市蔚州郡清涼邑處容產業 3 街 135,
輕工業 2 號樓 3 層西區
[74] 衛好知識產權有限公司
香港
木星街 9 號
永昇中心 2002



-
- [11] 2119170.5
[15] 16-12-2021
[30] 26-10-2021 / KR / 30-2021-0050633
[51] Cl. 4-02
[54] 電子牙刷刷頭
Head of electric toothbrush
[73] 株式會社普若希醫療保健
Proxihealthcare Inc.
大韓民國
蔚山廣域市蔚州郡清涼邑處容產業 3 街 135,
輕工業 2 號樓 3 層西區
[74] 衛好知識產權有限公司
香港

木星街 9 號
永昇中心 2002



-
- [11] 2119171.7
[15] 16-12-2021
[30] 26-10-2021 / KR / 30-2021-0050631
[51] C1. 4-02
[54] 電子牙刷刷頭
Head of electric toothbrush
[73] 株式會社普若希醫療保健
Proxihealthcare Inc.
大韓民國
蔚山廣域市蔚州郡清涼邑處容產業 3 街 135
輕工業 2 號樓 3 層西區
[74] 衛好知識產權有限公司
香港
木星街 9 號
永昇中心 2002



[11] 2119182.0

[15] 17-12-2021

[30] 24-09-2021 / JP / 020571 of 2021

[51] Cl. 18-01

[54] 電子計算器

Electronic calculator

[73] 卡西歐計算機株式會社

CASIO KEISANKI KABUSHIKI KAISHA d.b.a. CASIO COMPUTER CO.,
LTD.

6-2, Honmachi 1-Chome,
Shibuya-Ku, Tokyo,
Japan

[74] CHINA PATENT AGENT (HONG KONG) LIMITED

22/F, Great Eagle Centre,
23 Harbour Road,
Wanchai, Hong Kong



- [11] 2119189.5
[15] 17-12-2021
[30] 14-09-2021 / CN / 202130607529.0
[51] Cl. 12-05
[54] 倉儲機器人
Warehouse robot
[73] 深圳市海柔創新科技有限公司
中國內地
廣東省深圳市寶安區西鄉街道南昌社區航城大道華豐國際機器人產業園 G 棟
G101-G111 號、二層 G201-G211 號 (郵編: 518000)
[74] 陳鄧郭律師行
香港灣仔
軒尼詩道 48-62 號
上海實業大廈 25 樓 2503-2504 室

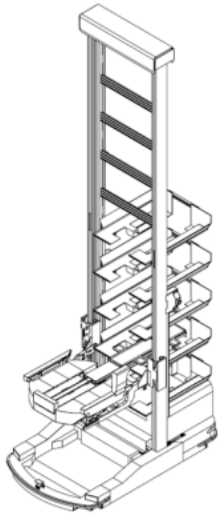

-
- [11] 2119218.8
[15] 23-12-2021
[51] Cl. 29-02
[54] 口罩
Mask
[73] 愛的家 (香港) 醫療器械防護科技有限公司
AIDEJIA (HONG KONG) MEDICAL DEVICE PROTECTION TECHNOLOGY
COMPANY LIMITED
香港九龍
紅磡凱旋工商中心三期
三樓 M1 室

- [74] 愛的家（香港）醫療器械防護科技有限公司
香港九龍
紅磡凱旋工商中心三期
三樓 M1 室



-
- [11] 2119242.8
[15] 30-12-2021
[51] C1. 9-05
[54] 包裝袋
Packaging bag
[73] 吳建明
NG KIN MING
香港柴灣
嘉業街 18 號
明報工業中心 B 座 1910-1911 室
[74] 卓遠知識產權有限公司
香港上環
禧利街 27 號
富輝商業中心 10 樓



-
- [11] 2119251.7
[15] 31-12-2021

[30] 12-11-2021 / CN / 202130745682.X

[51] Cl. 10-02

[54] 手錶表頭
Watch dial

[73] 深圳天舶腕表有限公司
中國內地
廣東省深圳市南山區西麗街道
白芒社區白芒村北 100 號
經緯大廈 204

[74] 普衡知識產權代理有限公司
香港上環
永樂街 72-74 號
永利大廈 9 字樓 C 室

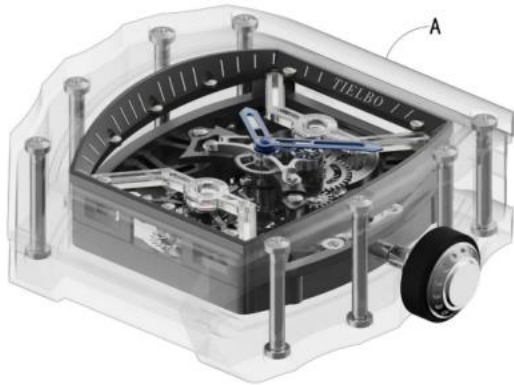

[11] 2219252.0M001

[15] 03-01-2022

[30] 14-10-2021 / MA, NO, OM, SG, CH, TN, TR, UA, GB, EU, AL /
DM/216 929

[51] Cl. 10-02

[54] 手錶
Wristwatch

[73] SWATCH AG (SWATCH SA) (SWATCH LTD.)
Nicolas G. Hayek Strasse 1,
2502 Biel/Bienne,
Switzerland

[74] SPRUSON & FERGUSON (HONG KONG) LIMITED
5001 Hopewell Centre,
183 Queen's Road East,
Wan Chai, Hong Kong



[11] 2219252.0M002

[15] 03-01-2022

[30] 14-10-2021 / MA, NO, OM, SG, CH, TN, TR, UA, GB, EU, AL /
DM/216 929

[51] Cl. 10-02

[54] 手錶

Wristwatch

[73] SWATCH AG (SWATCH SA) (SWATCH LTD.)

Nicolas G. Hayek Strasse 1,
2502 Biel/Bienne,
Switzerland

[74] SPRUSON & FERGUSON (HONG KONG) LIMITED

5001 Hopewell Centre,
183 Queen's Road East,
Wan Chai, Hong Kong



[11] 2219257.1

[15] 04-01-2022

[30] 06-07-2021 / EU / 008604466-0001

[51] Cl. 2-04

[54] 鞋

Shoes

[73] BALENCIAGA

40 rue de Sèvres,
75007 Paris,
France

[74] DEACONS

5th Floor, Alexandra House,

Central,
Hong Kong



[11] 2219260.7M001

[15] 04-01-2022

[30] 13-09-2021 / EU / 008679237-0001

[51] Cl. 12-16

[54] 汽車附件

Accessories for vehicles

[73] Dr. Ing. h.c. F. Porsche Aktiengesellschaft

Porscheplatz 1,

70435 Stuttgart,

Germany

[74] WENPING PATENT & TRADE MARK AGENT LIMITED

1701 Tung Wai Commercial Building,

111 Gloucester Road,

Hong Kong



[11] 2219260.7M002

[15] 04-01-2022

[30] 13-09-2021 / EU / 008679237-0003

[51] Cl. 12-16

[54] 汽車附件

Accessories for vehicles

[73] Dr. Ing. h.c. F. Porsche Aktiengesellschaft
Porscheplatz 1,
70435 Stuttgart,
Germany

[74] WENPING PATENT & TRADE MARK AGENT LIMITED
1701 Tung Wai Commercial Building,
111 Gloucester Road,
Hong Kong

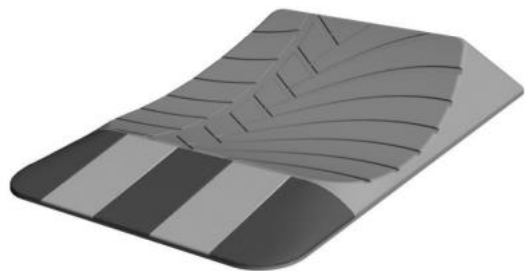

[11] 2219273.4

[15] 10-01-2022

[30] 09-07-2021 / US, EU, JP / WIPO106637

[51] Cl. 9-01

[54] 帶蓋子的瓶
Flask with lid

[73] 道達爾尤格靈有限責任公司
TOTAL JUGGLING S.R.L.
Via E. Mattei,
1/C 30020 Marcon (VE),
Italy

[74] CHINAHONGKONG IP LIMITED
1502, 15/F, Capital Centre,
151 Gloucester Road,
Wanchai, Hong Kong

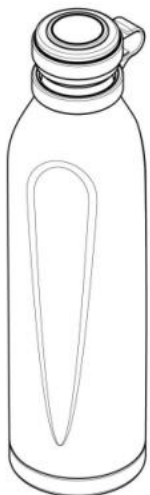

[11] 2219286.2

[15] 12-01-2022

[30] 16-07-2021 / JP / 015554 of 2021

[51] Cl. 7-02

[54] 咖啡機

Coffee maker

[73] SENGOKU WORKS, LTD.

395, Bessho-Cho, Kasai-Shi,

Hyogo 675-2462

Japan

[74] GLOBAL IP AGENT COMPANY LIMITED

9/F., Goodwill Industrial Building,

36-44 Pak Tin Par Street,

Tsuen Wan, Hong Kong



[11] 2219295.1

[15] 14-01-2022

[51] Cl. 2-02

[54] 長褲或短褲的切口袋

Slash pocket for pants or shorts

[73] United Colors International Limited

10/F, Edwick Industrial Centre,

4-30 Lei Muk Road,

Kwai Chung, Hong Kong

[74] SO KEUNG YIP & SIN

Room 1009-1012, 10/F., Nan Fung Tower,

No. 173 Des Voeux Road Central,

Hong Kong

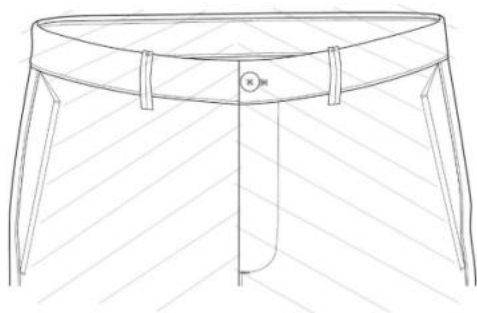

[11] 2219299.9M001

[15] 14-01-2022

[30] 19-07-2021 / CA, EG, MX, MC, MA, NO, RU, SG, CH, TN, TR, UA,
GB, US, VN, EU, JP, KR / DM/215 676

[51] Cl. 3-01

[54] 袋

Bag

[73] HERMES SELLIER

24, Rue du Faubourg Saint-Honoré,

75008 Paris,

France

[74] DEACONS

5th Floor,

Alexandra House,

Central, Hong Kong



[11] 2219299.9M002

[15] 14-01-2022

[30] 19-07-2021 / CA, EG, MX, MC, MA, NO, RU, SG, CH, TN, TR, UA,
GB, US, VN, EU, JP, KR / DM/215 522

[51] Cl. 3-01

[54] 袋
Bag

[73] HERMES SELIER
24, Rue du Faubourg Saint-Honoré,
75008 Paris,
France

[74] DEACONS
5th Floor,
Alexandra House,
Central, Hong Kong



[11] 2219299.9M003

[15] 14-01-2022

[30] 19-07-2021 / CA, EG, MX, MC, MA, NO, RU, SG, CH, TN, TR, UA,
GB, US, VN, EU, JP, KR / DM/215 668

[51] Cl. 3-01

[54] 袋

Bag

[73] HERMES SELLIER

24, Rue du Faubourg Saint-Honoré,

75008 Paris,

France

[74] DEACONS

5th Floor,

Alexandra House,

Central, Hong Kong



[11] 2219299.9M004

[15] 14-01-2022

[30] 19-07-2021 / CA, EG, MX, MC, MA, NO, RU, SG, CH, TN, TR, UA,
GB, US, VN, EU, JP, KR / DM/215 526

[51] Cl. 3-01

[54] 背包

Rucksack

[73] HERMES SELLIER

24, Rue du Faubourg Saint-Honoré,

75008 Paris,

France

[74] DEACONS

5th Floor,

Alexandra House,

Central, Hong Kong



[11] 2219299.9M005

[15] 14-01-2022

[30] 19-07-2021 / CA, EG, MX, MC, MA, NO, RU, SG, CH, TN, TR, UA,
GB, US, VN, EU, JP, KR / DM/215 523

[51] Cl. 3-01

[54] 卡片夾

Cards holder

[73] HERMES SELLIER

24, Rue du Faubourg Saint-Honoré,
75008 Paris,
France

[74] DEACONS

5th Floor,
Alexandra House,
Central, Hong Kong



[11] 2219299.9M006

[15] 14-01-2022

[30] 20-07-2021 / CA, EG, MX, MC, MA, NO, RU, SG, CH, TN, TR, UA,
GB, US, VN, EU, JP, KR / DM/215 546

[51] Cl. 3-01

[54] 眼鏡盒

Case for glasses

[73] HERMES SELLIER

24, Rue du Faubourg Saint-Honoré,
75008 Paris,
France

[74] DEACONS

5th Floor,
Alexandra House,
Central, Hong Kong



[11] 2219300.3

[15] 17-01-2022

[51] Cl. 9-01

[54] 容器

Container

[73] AXXZIA 股份有限公司

AXXZIA INC.
6-3-1 Nishi-Shinjuku,
Shinjuku-ku, Tokyo,
Japan

[74] CLT PATENT & TRADEMARK (H.K.) LIMITED

Unit 09, 34/F., Office Tower,
Convention Plaza, No. 1 Harbour Road,
Wanchai, Hong Kong



[11] 2219301.5

[15] 17-01-2022

[30] 21-07-2021 / CN / 202130464256.9

[51] Cl. 7-03

[54] 餐刀

Knife for table use

[73] 歌樂電磁(深圳)有限公司

Kolor Magnetic (Shenzhen) Co., Ltd.

中國內地

廣東省深圳市龍崗區

橫崗鎮六約鄉牛始埔村

[74] HK STANDARD INTELLECTUAL PROPERTY LIMITED

香港中環

干諾道中 64 號

中華廠商會大廈 21 樓



[11] 2219303.9M001

[15] 18-01-2022

[30] 11-08-2021 / JP / 017384 of 2021

[51] Cl. 9-03

[54] 包裝盒

Packing box

[73] 久光製藥株式會社

HISAMITSU PHARMACEUTICAL CO., INC.

408, Tashirodaikan-machi,

Tosu-shi, Saga 841-0017,

Japan

[74] WILKINSON & GRIST

6th Floor, Prince's Building,

Chater Road,

Hong Kong



[11] 2219303.9M002

[15] 18-01-2022

[30] 11-08-2021 / JP / 017384 of 2021

[51] Cl. 9-03

[54] 包裝盒

Packing box

[73] 久光製藥株式會社

HISAMITSU PHARMACEUTICAL CO., INC.

408, Tashirodaikan-machi,

Tosu-shi, Saga 841-0017,

Japan

[74] WILKINSON & GRIST

6th Floor, Prince's Building,

Chater Road,

Hong Kong



[11] 2219305.4M001

[15] 18-01-2022

[30] 20-08-2021 / CA, AM, AZ, BZ, BA, GE, LI, MK, MD, MC, MN, ME, MA, NO, OM, SG, CH, TN, TR, UA, GB, EU, AL, KG / DM/216 037

[51] Cl. 11-01

[54] 飾針

Brooch

[73] Harry Winston SA

Chemin du Tourbillon 8,
CH-1228 Plan-les-Ouates,
Switzerland

[74] SPRUSON & FERGUSON (HONG KONG) LIMITED

5001 Hopewell Centre,
183 Queen's Road East,
Wan Chai, Hong Kong



- [11] 2219305.4M002
[15] 18-01-2022
[30] 20-08-2021 / CA, AM, AZ, BZ, BA, GE, LI, MK, MD, MC, MN, ME, MA, NO, OM, SG, CH, TN, TR, UA, GB, EU, AL, KG / DM/216 037
[51] Cl. 11-01
[54] 飾針
Brooch
[73] Harry Winston SA
Chemin du Tourbillon 8,
CH-1228 Plan-les-Ouates,
Switzerland
[74] SPRUSON & FERGUSON (HONG KONG) LIMITED
5001 Hopewell Centre,
183 Queen's Road East,
Wan Chai, Hong Kong



-
- [11] 2219305.4M003
[15] 18-01-2022
[30] 20-08-2021 / CA, AM, AZ, BZ, BA, GE, LI, MK, MD, MC, MN, ME, MA, NO, OM, SG, CH, TN, TR, UA, GB, EU, AL, KG / DM/216 037
[51] Cl. 11-01
[54] 飾針
Brooch
[73] Harry Winston SA
Chemin du Tourbillon 8,
CH-1228 Plan-les-Ouates,
Switzerland
[74] SPRUSON & FERGUSON (HONG KONG) LIMITED
5001 Hopewell Centre,
183 Queen's Road East,
Wan Chai, Hong Kong



[11] 2219305.4M004

[15] 18-01-2022

[30] 20-08-2021 / CA, AM, AZ, BZ, BA, GE, LI, MK, MD, MC, MN, ME, MA, NO, OM, SG, CH, TN, TR, UA, GB, EU, AL, KG / DM/216 037

[51] Cl. 11-01

[54] 飾針

Brooch

[73] Harry Winston SA

Chemin du Tourbillon 8,
CH-1228 Plan-les-Ouates,
Switzerland

[74] SPRUSON & FERGUSON (HONG KONG) LIMITED

5001 Hopewell Centre,
183 Queen's Road East,
Wan Chai, Hong Kong



[11] 2219305.4M005

[15] 18-01-2022

[30] 20-08-2021 / CA, AM, AZ, BZ, BA, GE, LI, MK, MD, MC, MN, ME, MA, NO, OM, SG, CH, TN, TR, UA, GB, EU, AL, KG / DM/216 037

[51] Cl. 11-01

[54] 項鍊

Necklace

[73] Harry Winston SA

Chemin du Tourbillon 8,

CH-1228 Plan-les-Ouates,
Switzerland

- [74] SPRUSON & FERGUSON (HONG KONG) LIMITED
5001 Hopewell Centre,
183 Queen's Road East,
Wan Chai, Hong Kong



-
- [11] 2219305.4M006
[15] 18-01-2022
[30] 20-08-2021 / CA, AM, AZ, BZ, BA, GE, LI, MK, MD, MC, MN, ME,
MA, NO, OM, SG, CH, TN, TR, UA, GB, EU, AL, KG / DM/216 037
[51] Cl. 11-01
[54] 項鍊
Necklace
[73] Harry Winston SA
Chemin du Tourbillon 8,
CH-1228 Plan-les-Ouates,
Switzerland
[74] SPRUSON & FERGUSON (HONG KONG) LIMITED
5001 Hopewell Centre,
183 Queen's Road East,
Wan Chai, Hong Kong



-
- [11] 2219305.4M007
[15] 18-01-2022
[30] 20-08-2021 / CA, AM, AZ, BZ, BA, GE, LI, MK, MD, MC, MN, ME,
MA, NO, OM, SG, CH, TN, TR, UA, GB, EU, AL, KG / DM/216 037
[51] Cl. 11-01

[54] 吊墜

Pendant

[73] Harry Winston SA

Chemin du Tourbillon 8,
CH-1228 Plan-les-Ouates,
Switzerland

[74] SPRUSON & FERGUSON (HONG KONG) LIMITED

5001 Hopewell Centre,
183 Queen's Road East,
Wan Chai, Hong Kong



[11] 2219310.4M001

[15] 19-01-2022

[51] Cl. 10-02

[54] 手動上鏈陀飛輪腕錶

Manual-winding mechanical watch

[73] 萬希泉鐘錶有限公司

Memorigin Watch Company Limited

香港柴灣

永泰道 60 號

柴灣工業城一期 8 樓 803-4 室

[74] 萬希泉鐘錶有限公司

香港柴灣

永泰道 60 號

柴灣工業城一期 8 樓 803-4 室



[11] 2219310.4M002

[15] 19-01-2022

[51] Cl. 10-02

[54] 手動上鏈陀飛輪腕錶

Manual-winding mechanical watch

[73] 萬希泉鐘錶有限公司

Memorigin Watch Company Limited

香港柴灣

永泰道 60 號

柴灣工業城一期 8 樓 803-4 室

[74] 萬希泉鐘錶有限公司

香港柴灣

永泰道 60 號

柴灣工業城一期 8 樓 803-4 室



[11] 2219312.8M001

[15] 19-01-2022

[30] 05-08-2021 / EU / 008640189-0001

[51] Cl. 15-07

[54] 冷凍櫃

Freezer cabinet

[73] Unilever IP Holdings B.V.

Weena 455,
3013 AL Rotterdam,
Netherlands

[74] NTD PATENT & TRADE MARK AGENCY LIMITED

Units 1805-6, 18/F.,
Greenfield Tower, Concordia Plaza,
No. 1 Science Museum Road,
Tsim Sha Tsui East, Kowloon, Hong Kong

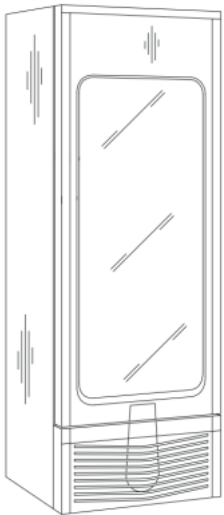

[11] 2219312.8M002

[15] 19-01-2022

[30] 05-08-2021 / EU / 008640171-0001

[51] Cl. 15-07

[54] 冷凍櫃

Freezer cabinet

[73] Unilever IP Holdings B.V.

Weena 455,
3013 AL Rotterdam,
Netherlands

[74] NTD PATENT & TRADE MARK AGENCY LIMITED

Units 1805-6, 18/F.,
Greenfield Tower, Concordia Plaza,

No. 1 Science Museum Road,
Tsim Sha Tsui East, Kowloon, Hong Kong

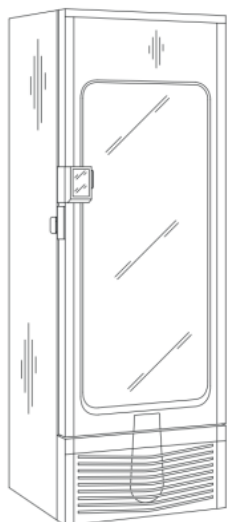

[11] 2219312.8M003

[15] 19-01-2022

[30] 05-08-2021 / EU / 008640155-0001

[51] Cl. 15-07

[54] 冷凍櫃

Freezer cabinet

[73] Unilever IP Holdings B.V.

Weena 455,

3013 AL Rotterdam,

Netherlands

[74] NTD PATENT & TRADE MARK AGENCY LIMITED

Units 1805-6, 18/F.,

Greenfield Tower, Concordia Plaza,

No. 1 Science Museum Road,

Tsim Sha Tsui East, Kowloon, Hong Kong

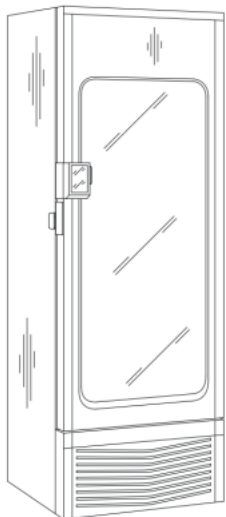

[11] 2219317.9

[15] 20-01-2022

[30] 16-11-2021 / EU / 008761217-0001

[51] Cl. 21-01

[54] 模型車

Model car

[73] Dr. Ing. h.c. F. Porsche Aktiengesellschaft

Porscheplatz 1,
70435 Stuttgart,
Germany

[74] WENPING PATENT & TRADE MARK AGENT LIMITED

1701 Tung Wai Commercial Building,
111 Gloucester Road,
Hong Kong





香港特別行政區政府知識產權署外觀設計註冊處

The Government of the Hong Kong Special Administrative Region

Designs Registry, Intellectual Property Department

根據註冊外觀設計條例第 28 條，下列註冊外觀設計因未繳續期費而停止有效。

各組記項按註冊外觀設計停止有效日期及註冊編號先後次序排列。

Registered designs ceased through non-payment of renewal fees under section 28 of the Registered Designs Ordinance. Entries are listed below under their expiry dates.

28-01-2022 - 02-02-2022

28-01-2022	1200167.7M003
0700256.9	1200168.9
0700257.1	1700187.4

1700189.8

30-01-2022

0700292.4	1700190.0
0700293.6	1700191.2
0700299.9M001	1700192.4
0700299.9M002	1700196.3
1200108.3	1700197.5M001
1200146.3M001	1700197.5M002
1200146.3M002	1700197.5M003
1200146.3M003	

31-01-2022

1200147.5M001
1200147.5M002
1200148.7
1200149.9
1200151.3
1700166.0M002
1700166.0M003
1700167.2

01-02-2022

0700317.9M001
1700177.3
1700178.5
1700181.1

02-02-2022

1200165.3
1200167.7M001
1200167.7M002



香港特別行政區政府知識產權署外觀設計註冊處

The Government of the Hong Kong Special Administrative Region

Designs Registry, Intellectual Property Department

根據註冊外觀設計規則第 31 條刪除的註冊外觀設計。各組記項按註冊外觀設計刪除日期及註冊編號先後次序排列。

Registered designs removed under section 31 of the Registered Designs Rules. Entries are listed below under their removal dates.

04-02-2022 - 10-02-2022

04-02-2022	1101314.9M003
1601466.6	1101314.9M004
1601467.8	1101314.9M005
	1101314.9M006

05-02-2022	1101315.2M001
1101287.1	1101315.2M002
1101291.9	1601479.3
1601470.4	1601481.7
1601473.0	1601482.9M001
1601474.2	1601482.9M002
	1601482.9M003

07-02-2022	1601482.9M004
0111106.9M003	1601482.9M005
0111106.9M004	1601482.9M006
0111106.9M005	1601482.9M007
0111106.9M006	1601482.9M008
0602004.6M001	

08-02-2022	
0111130.9	
1101298.4M001	
1101298.4M002	
1101298.4M003	
1601335.9M001	
1601335.9M002	
1601476.7M001	
1601476.7M002	

09-02-2022	
0602059.2	

10-02-2022	
1101314.9M001	
1101314.9M002	