

香港知識產權公報

Hong Kong Intellectual Property Journal

2019 年 7 月 26 日

26 July 2019

目錄

Contents

根據註冊外觀設計條例第 25 條註冊的外觀設計

Designs Registered under section 25 of the Registered Designs Ordinance

按註冊編號排列

Arranged by Registration Number

根據註冊外觀設計條例(第 522 章)公布的其他公告

Other Notices Published under the Registered Designs Ordinance (Cap. 522)

根據註冊外觀設計條例第 28 條, 註冊外觀設計因未繳續期費而停止有效

Registered designs ceased through non-payment of renewal fees under section 28 of the Registered Designs Ordinance

根據註冊外觀設計規則第 31 條刪除的註冊外觀設計

Registered designs removed under section 31 of the Registered Designs Rules

根據註冊外觀設計條例第 67 及 76 條, 更正註冊紀錄冊內及已提交文件中的錯誤

Correction of Errors in Register and in Filed Documents under sections 67 and 76 of the Registered Designs Ordinance

以下事項沒有記錄

No Records for the Following Matters

根據註冊外觀設計條例第 30 條放棄的外觀設計的註冊

Surrender of Registration of Design under section 30 of the Registered Designs Ordinance

根據註冊外觀設計規則第 37 條, 向處長作出轉介

Reference to Registrar under section 37 of the Registered Designs Rules

根據註冊外觀設計條例第 45 條, 撤銷註冊

Revocation of Registration under section 45 of the Registered Designs Ordinance

根據註冊外觀設計規則第 46 條, 向法院作出轉介

Reference to Court under section 46 of the Registered Designs Rules

根據註冊外觀設計規則第 63 條對不符合規定之處作出糾正

Rectification of Irregularities under section 63 of the Registered Designs Rules

根據註冊外觀設計條例第 66 條, 糾正註冊紀錄冊

Rectification of Register under section 66 of the Registered Designs Ordinance

根據註冊外觀設計條例第 67 條, 更正註冊紀錄冊內的錯誤

Correction of Errors in Register under section 67 of the Registered Designs Ordinance

根據註冊外觀設計條例第 76 條, 更正已提交文件中的錯誤

Correction of Errors in Filed Documents under section 76 of the Registered Designs Ordinance

勘誤

Corrigendum

註冊外觀設計公告註釋

Notes on advertisements of registration of designs

方括號表示下列資料：

Square brackets indicate the following data：

[11] 註冊編號 Registration number / 聯合王國註冊編號 United Kingdom registration number

[15] 註冊日期 Registration date / 當作註冊日期 Deemed registration date / 聯合王國註冊日期 United Kingdom registration date

[17] 註冊有效期屆滿日期 Expiry date of the period of registration

[22] 提交日期 Filing date / 當作提交日期 Deemed filing date / 聯合王國提交日期 United Kingdom filing date

[30] 聲稱享有的優先權 (提交日期 / 巴黎公約國或世界貿易組織成員 / 申請編號) Priority claimed (filing date / Paris Convention country or WTO member / application number)

[51] 國際外觀設計分類號 (洛迦諾分類號) International Classification of designs (Locarno Classification)

[54] 物品 Article

[55] 外觀設計的表述 Representation of the design

[62] 分開前的申請編號及提交日期 Application number before division and filing date

[66] 過往註冊的聯繫外觀設計註冊編號 / 日期 Registration No. / Date of Previous Registration for Association

[72] 設計人 Designer

[73] 擁有人姓名和地址 Name and address of the owner

[74] 代理人 Agent / 送達地址 Address for service



香港特別行政區政府知識產權署外觀設計註冊處

The Government of the Hong Kong Special Administrative Region

Designs Registry, Intellectual Property Department

根據註冊外觀設計條例第 25 條註冊的外觀設計

Designs registered under section 25 of the Registered Designs Ordinance

按註冊編號排列

Arranged by Registration Number

[11] 1900063.3M001

[15] 10-01-2019

[30] 10-07-2018 / US / 29/656,127

[51] Cl. 20-02

[54] 零售展示單元

Retail display unit

[73] 蘋果公司

APPLE INC.

ONE APPLE PARK WAY, CUPERTINO,

CALIFORNIA 95014, U.S.A.

UNITED STATES

[74] CLT Patent & Trademark (H.K.) Ltd.

Unit 09, 34/F., Office Tower,

Convention Plaza, No. 1 Harbour Road,

Wanchai, Hong Kong.

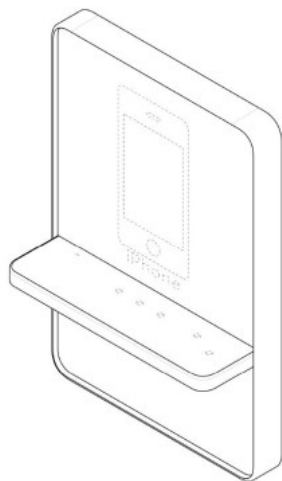

[11] 1900063.3M002

- [15] 10-01-2019
- [30] 10-07-2018 / US / 29/656,127
- [51] Cl. 20-02
- [54] 零售展示單元
Retail display unit
- [73] 蘋果公司
APPLE INC.
ONE APPLE PARK WAY, CUPERTINO,
CALIFORNIA 95014, U.S.A.
UNITED STATES
- [74] CLT Patent & Trademark (H.K.) Ltd.
Unit 09, 34/F., Office Tower,
Convention Plaza, No. 1 Harbour Road,
Wanchai, Hong Kong.

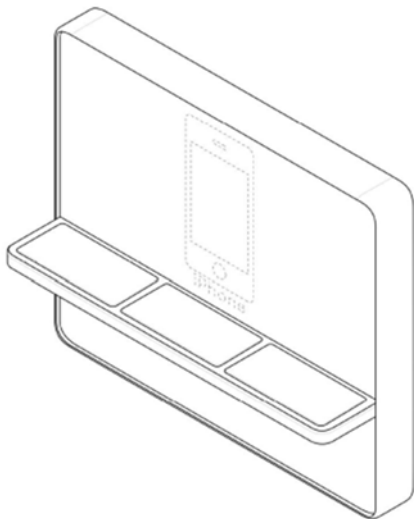

-
- [11] 1900063.3M003
- [15] 10-01-2019
- [30] 10-07-2018 / US / 29/656,127
- [51] Cl. 20-02
- [54] 零售展示單元
Retail display unit
- [73] 蘋果公司
APPLE INC.
ONE APPLE PARK WAY, CUPERTINO,
CALIFORNIA 95014, U.S.A.
UNITED STATES
- [74] CLT Patent & Trademark (H.K.) Ltd.
Unit 09, 34/F., Office Tower,
Convention Plaza, No. 1 Harbour Road,
Wanchai, Hong Kong.

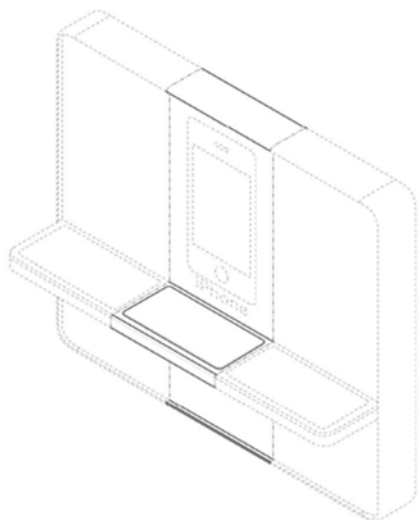

[11] 1900063.3M004

[15] 10-01-2019

[30] 10-07-2018 / US / 29/656,127

[51] Cl. 20-02

[54] 零售展示單元

Retail display unit

[73] 蘋果公司

APPLE INC.

ONE APPLE PARK WAY, CUPERTINO,

CALIFORNIA 95014, U.S.A.

UNITED STATES

[74] CLT Patent & Trademark (H.K.) Ltd.

Unit 09, 34/F., Office Tower,

Convention Plaza, No. 1 Harbour Road,

Wanchai, Hong Kong.

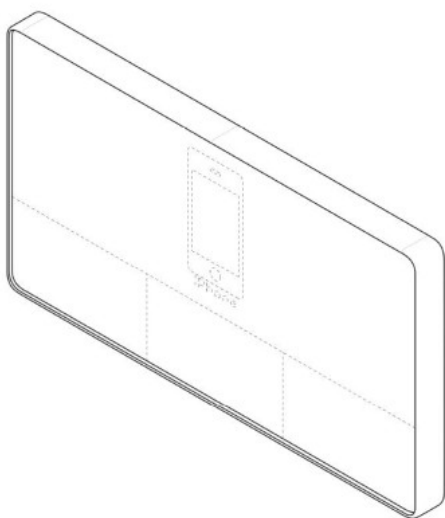

[11] 1900064.5M001

[15] 10-01-2019

[30] 10-07-2018 / US / 29/656,129

[51] Cl. 20-02

[54] 零售展示單元

Retail display unit

[73] 蘋果公司

APPLE INC.

ONE APPLE PARK WAY,

CUPERTINO, CALIFORNIA 95014,

UNITED STATES

[74] CLT Patent & Trademark (H.K.) Ltd.

Unit 09, 34/F., Office Tower,

Convention Plaza, No. 1 Harbour Road,

Wanchai, Hong Kong.

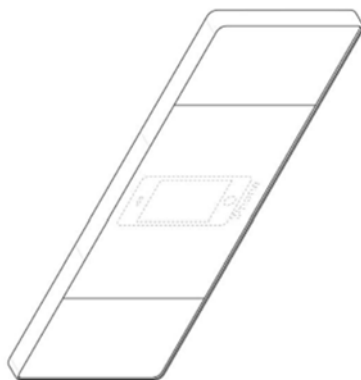

[11] 1900064.5M002

[15] 10-01-2019

[30] 10-07-2018 / US / 29/656,129

[51] Cl. 20-02

[54] 零售展示單元

Retail display unit

[73] 蘋果公司

APPLE INC.

ONE APPLE PARK WAY,

CUPERTINO, CALIFORNIA 95014,

UNITED STATES

[74] CLT Patent & Trademark (H.K.) Ltd.

Unit 09, 34/F., Office Tower,

Convention Plaza, No. 1 Harbour Road,
Wanchai, Hong Kong.

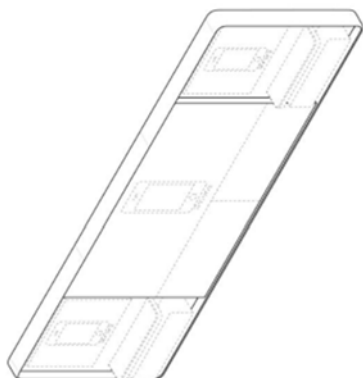

[11] 1900064.5M003

[15] 10-01-2019

[30] 10-07-2018 / US / 29/656,129

[51] Cl. 20-02

[54] 零售展示單元

Retail display unit

[73] 蘋果公司

APPLE INC.

ONE APPLE PARK WAY,

CUPERTINO, CALIFORNIA 95014,

UNITED STATES

[74] CLT Patent & Trademark (H.K.) Ltd.

Unit 09, 34/F., Office Tower,

Convention Plaza, No. 1 Harbour Road,

Wanchai, Hong Kong.

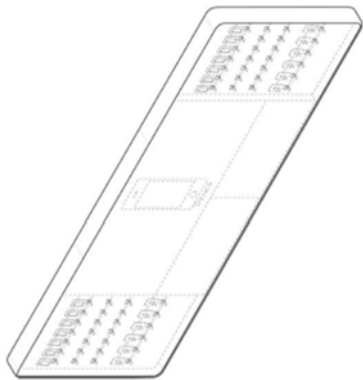

[11] 1900067.2M001

[15] 10-01-2019

[51] Cl. 6-01

[54] 椅子

Chair

[73] Prism Concept Limited

62, 7/F, Block 3,
140 Pokfulam Road,
Hong Kong

[74] Accolade IP Limited

Room 702, 7/F.,
Fu Fai Commercial Centre,
27 Hillier Street, Hong Kong.



[11] 1900067.2M002

[15] 10-01-2019

[51] Cl. 6-01

[54] 椅子

Chair

[73] Prism Concept Limited

62, 7/F, Block 3,
140 Pokfulam Road,
Hong Kong

[74] Accolade IP Limited

Room 702, 7/F.,
Fu Fai Commercial Centre,
27 Hillier Street, Hong Kong.



[11] 1900067.2M003

[15] 10-01-2019

[51] Cl. 6-01

[54] 椅子

Chair

[73] Prism Concept Limited

62, 7/F, Block 3,
140 Pokfulam Road,
Hong Kong

[74] Accolade IP Limited

Room 702, 7/F.,
Fu Fai Commercial Centre,
27 Hillier Street, Hong Kong.



[11] 1900076.1

[15] 11-01-2019

[51] Cl. 8-08

[54] 螺旋掛環

Spiral hanging rack

[73] 王維正

台灣台北市

瑞光路 268 號 7 樓

[74] 禡志忠

香港九龍牛頭角 樂

雅苑 D 座 808 室

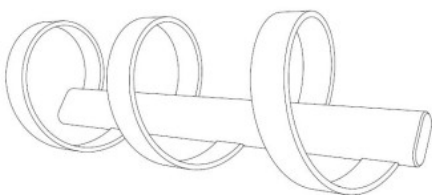

[11] 1900077.3

[15] 11-01-2019

[51] Cl. 7-07

[54] 腳踏式髒衣籃

Step-on laundry basket

[73] 王維正
台灣台北市
瑞光路 268 號 7 樓

[74] 禰志忠
香港九龍牛頭角 樂
雅苑 D 座 808 室

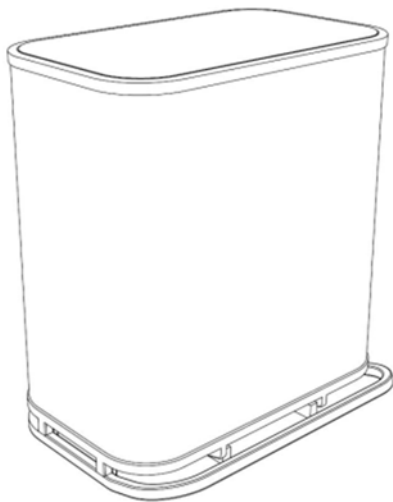

[11] 1900079.7M001

[15] 11-01-2019

[30] 13-07-2018 / US / 29/656,638

[51] Cl. 10-02

[54] 智能手錶
Smart watch

[73] Fitbit, Inc.
199 Fremont St., 14th Floor,
San Francisco, CA 94105,
UNITED STATES

[74] Barron & Young Intellectual Property Limited
Suite 617, Lakeside 2,
No. 10 Science Park West Avenue,
Hong Kong Science Park, N.T., Hong Kong.



[11] 1900079.7M002

[15] 11-01-2019

[30] 13-07-2018 / US / 29/656,638

[51] Cl. 10-07

[54] 智能手錶的錶帶

Band of smart watch

[73] Fitbit, Inc.

199 Fremont St., 14th Floor,

San Francisco, CA 94105,

UNITED STATES

[74] Barron & Young Intellectual Property Limited

Suite 617, Lakeside 2,

No. 10 Science Park West Avenue,

Hong Kong Science Park, N.T., Hong Kong.

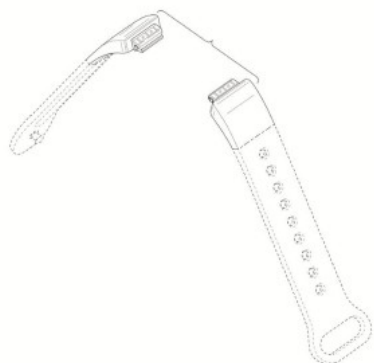

[11] 1900079.7M003

[15] 11-01-2019

[30] 13-07-2018 / US / 29/656,638

[51] Cl. 10-02

[54] 智能手錶的主體

Body of smart watch

[73] Fitbit, Inc.

199 Fremont St., 14th Floor,

San Francisco, CA 94105,

UNITED STATES

[74] Barron & Young Intellectual Property Limited

Suite 617, Lakeside 2,

No. 10 Science Park West Avenue,

Hong Kong Science Park, N.T., Hong Kong.



[11] 1900079.7M004

[15] 11-01-2019

[30] 13-07-2018 / US / 29/656,638

[51] Cl. 10-02

[54] 智能手錶的主體

Body of smart watch

[73] Fitbit, Inc.

199 Fremont St., 14th Floor,

San Francisco, CA 94105,

UNITED STATES

[74] Barron & Young Intellectual Property Limited

Suite 617, Lakeside 2,

No. 10 Science Park West Avenue,

Hong Kong Science Park, N.T., Hong Kong.



[11] 1900079.7M005

[15] 11-01-2019

[30] 13-07-2018 / US / 29/656,638

[51] Cl. 10-02

[54] 智能手錶

Smart watch

[73] Fitbit, Inc.

199 Fremont St., 14th Floor,

San Francisco, CA 94105,

UNITED STATES

[74] Barron & Young Intellectual Property Limited

Suite 617, Lakeside 2,

No. 10 Science Park West Avenue,

Hong Kong Science Park, N.T., Hong Kong.

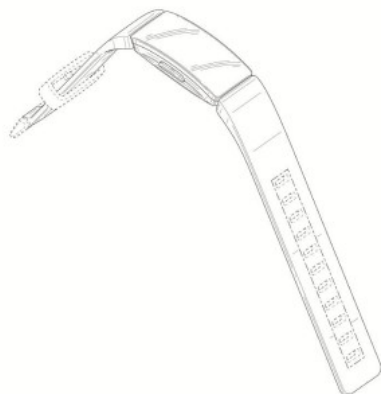

[11] 1900079.7M006

[15] 11-01-2019

[30] 13-07-2018 / US / 29/656,638

[51] Cl. 10-07

[54] 智能手錶的錶帶

Band of smart watch

- [73] Fitbit, Inc.
199 Fremont St., 14th Floor,
San Francisco, CA 94105,
UNITED STATES
- [74] Barron & Young Intellectual Property Limited
Suite 617, Lakeside 2,
No. 10 Science Park West Avenue,
Hong Kong Science Park, N.T., Hong Kong.



-
- [11] 1900079.7M007
- [15] 11-01-2019
- [30] 13-07-2018 / US / 29/656,638
- [51] Cl. 10-02
- [54] 智能手錶的主體
Body of smart watch
- [73] Fitbit, Inc.
199 Fremont St., 14th Floor,
San Francisco, CA 94105,
UNITED STATES
- [74] Barron & Young Intellectual Property Limited
Suite 617, Lakeside 2,
No. 10 Science Park West Avenue,
Hong Kong Science Park, N.T., Hong Kong.

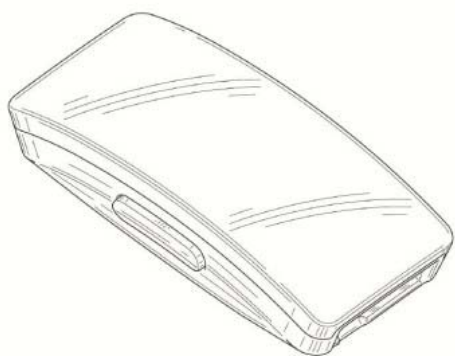

[11] 1900079.7M008

[15] 11-01-2019

[30] 13-07-2018 / US / 29/656,638

[51] Cl. 10-02

[54] 智能手錶的主體

Body of smart watch

[73] Fitbit, Inc.

199 Fremont St., 14th Floor,

San Francisco, CA 94105,

UNITED STATES

[74] Barron & Young Intellectual Property Limited

Suite 617, Lakeside 2,

No. 10 Science Park West Avenue,

Hong Kong Science Park, N.T., Hong Kong.



[11] 1900082.3

[15] 11-01-2019

[30] 09-01-2019 / EM / 005966504-003

[51] Cl. 11-01

[54] 手鐲

Bracelet

[73] CELINE
16 rue Vivienne - 75002 Paris,
FRANCE

[74] BAKER & MCKENZIE
14th Floor, One Taikoo Place
979 King's Road, Quarry Bay
HONG KONG

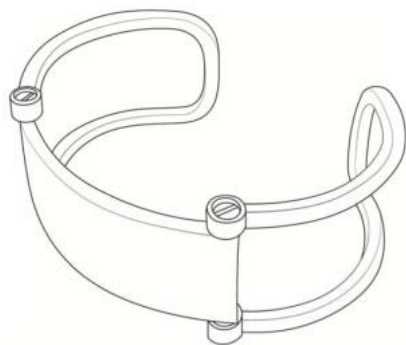

[11] 1900083.5

[15] 11-01-2019

[30] 09-01-2019 / EM / 005966504-004

[51] Cl. 11-01

[54] 手鐲

Bracelet

[73] CELINE
16 rue Vivienne - 75002 Paris,
FRANCE

[74] BAKER & MCKENZIE
14th Floor, One Taikoo Place
979 King's Road, Quarry Bay
HONG KONG

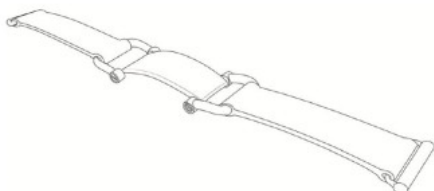

[11] 1900084.7M001

[15] 14-01-2019

[30] 13-07-2018 / US / 29/656,624

[51] Cl. 3-01

[54] 帶鍵盤的套

Cover with keyboard

[73] 蘋果公司

APPLE INC.

ONE APPLE PARK WAY, CUPERTINO,

CALIFORNIA 95014, U.S.A.

UNITED STATES

[74] CLT Patent & Trademark (H.K.) Ltd.

Unit 09, 34/F., Office Tower,

Convention Plaza, No. 1 Harbour Road,

Wanchai, Hong Kong.

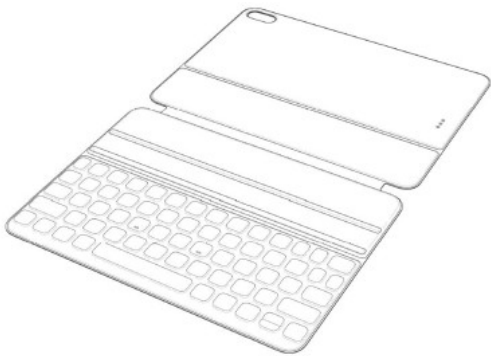

[11] 1900084.7M002

[15] 14-01-2019

[30] 13-07-2018 / US / 29/656,624

[51] Cl. 3-01

[54] 帶鍵盤的套

Cover with keyboard

[73] 蘋果公司

APPLE INC.

ONE APPLE PARK WAY, CUPERTINO,

CALIFORNIA 95014, U.S.A.

UNITED STATES

[74] CLT Patent & Trademark (H.K.) Ltd.

Unit 09, 34/F., Office Tower,

Convention Plaza, No. 1 Harbour Road,

Wanchai, Hong Kong.



[11] 1900084.7M003

[15] 14-01-2019

[30] 13-07-2018 / US / 29/656,624

[51] Cl. 3-01

[54] 帶鍵盤的套

Cover with keyboard

[73] 蘋果公司

APPLE INC.

ONE APPLE PARK WAY, CUPERTINO,

CALIFORNIA 95014, U.S.A.

UNITED STATES

[74] CLT Patent & Trademark (H.K.) Ltd.

Unit 09, 34/F., Office Tower,

Convention Plaza, No. 1 Harbour Road,

Wanchai, Hong Kong.

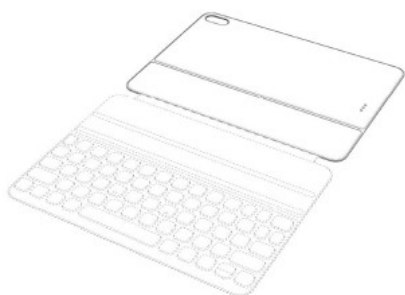

[11] 1900084.7M004

[15] 14-01-2019

[30] 13-07-2018 / US / 29/656,624

[51] Cl. 3-01

[54] 帶鍵盤的套
Cover with keyboard

[73] 蘋果公司
APPLE INC.
ONE APPLE PARK WAY, CUPERTINO,
CALIFORNIA 95014, U.S.A.
UNITED STATES

[74] CLT Patent & Trademark (H.K.) Ltd.
Unit 09, 34/F., Office Tower,
Convention Plaza, No. 1 Harbour Road,
Wanchai, Hong Kong.

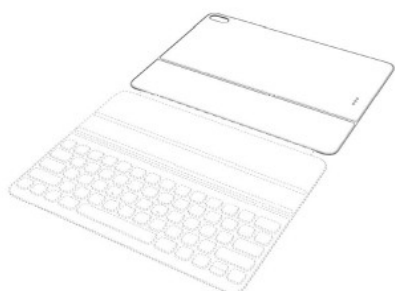

[11] 1900084.7M005

[15] 14-01-2019

[30] 13-07-2018 / US / 29/656,624

[51] Cl. 3-01

[54] 帶鍵盤的套
Cover with keyboard

[73] 蘋果公司
APPLE INC.
ONE APPLE PARK WAY, CUPERTINO,
CALIFORNIA 95014, U.S.A.
UNITED STATES

[74] CLT Patent & Trademark (H.K.) Ltd.
Unit 09, 34/F., Office Tower,
Convention Plaza, No. 1 Harbour Road,
Wanchai, Hong Kong.

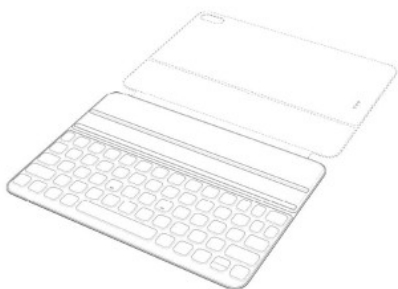

[11] 1900084.7M006

[15] 14-01-2019

[30] 13-07-2018 / US / 29/656,624

[51] Cl. 3-01

[54] 帶鍵盤的套

Cover with keyboard

[73] 蘋果公司

APPLE INC.

ONE APPLE PARK WAY, CUPERTINO,

CALIFORNIA 95014, U.S.A.

UNITED STATES

[74] CLT Patent & Trademark (H.K.) Ltd.

Unit 09, 34/F., Office Tower,

Convention Plaza, No. 1 Harbour Road,

Wanchai, Hong Kong.

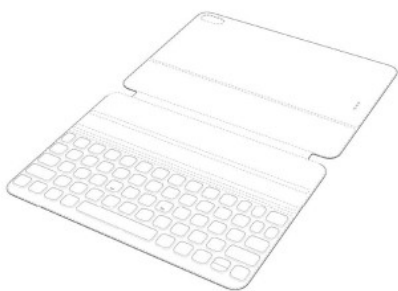

[11] 1900084.7M007

[15] 14-01-2019

[30] 13-07-2018 / US / 29/656,624

[51] Cl. 3-01

[54] 帶鍵盤的套
Cover with keyboard

[73] 蘋果公司
APPLE INC.
ONE APPLE PARK WAY, CUPERTINO,
CALIFORNIA 95014, U.S.A.
UNITED STATES

[74] CLT Patent & Trademark (H.K.) Ltd.
Unit 09, 34/F., Office Tower,
Convention Plaza, No. 1 Harbour Road,
Wanchai, Hong Kong.



[11] 1900084.7M008

[15] 14-01-2019

[30] 13-07-2018 / US / 29/656,624

[51] Cl. 3-01

[54] 帶鍵盤的套
Cover with keyboard

[73] 蘋果公司
APPLE INC.
ONE APPLE PARK WAY, CUPERTINO,
CALIFORNIA 95014, U.S.A.
UNITED STATES

[74] CLT Patent & Trademark (H.K.) Ltd.
Unit 09, 34/F., Office Tower,
Convention Plaza, No. 1 Harbour Road,
Wanchai, Hong Kong.

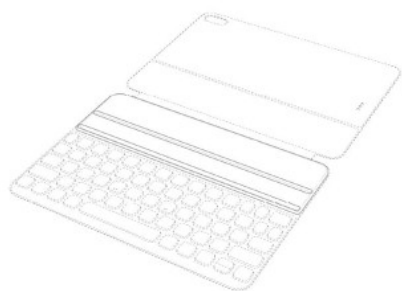

[11] 1900084.7M009

[15] 14-01-2019

[30] 13-07-2018 / US / 29/656,624

[51] Cl. 3-01

[54] 帶鍵盤的套

Cover with keyboard

[73] 蘋果公司

APPLE INC.

ONE APPLE PARK WAY, CUPERTINO,

CALIFORNIA 95014, U.S.A.

UNITED STATES

[74] CLT Patent & Trademark (H.K.) Ltd.

Unit 09, 34/F., Office Tower,

Convention Plaza, No. 1 Harbour Road,

Wanchai, Hong Kong.

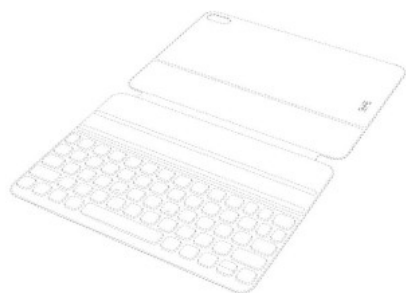

[11] 1900084.7M010

[15] 14-01-2019

[30] 13-07-2018 / US / 29/656,624

[51] Cl. 3-01

[54] 帶鍵盤的套
Cover with keyboard

[73] 蘋果公司
APPLE INC.
ONE APPLE PARK WAY, CUPERTINO,
CALIFORNIA 95014, U.S.A.
UNITED STATES

[74] CLT Patent & Trademark (H.K.) Ltd.
Unit 09, 34/F., Office Tower,
Convention Plaza, No. 1 Harbour Road,
Wanchai, Hong Kong.

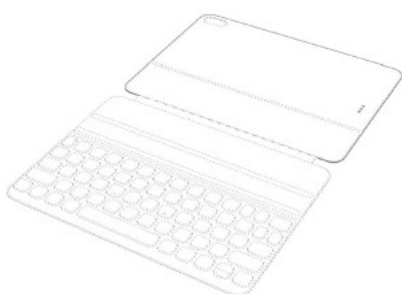

[11] 1900084.7M011

[15] 14-01-2019

[30] 13-07-2018 / US / 29/656,624

[51] Cl. 3-01

[54] 帶鍵盤的套
Cover with keyboard

[73] 蘋果公司
APPLE INC.
ONE APPLE PARK WAY, CUPERTINO,
CALIFORNIA 95014, U.S.A.
UNITED STATES

[74] CLT Patent & Trademark (H.K.) Ltd.
Unit 09, 34/F., Office Tower,
Convention Plaza, No. 1 Harbour Road,
Wanchai, Hong Kong.

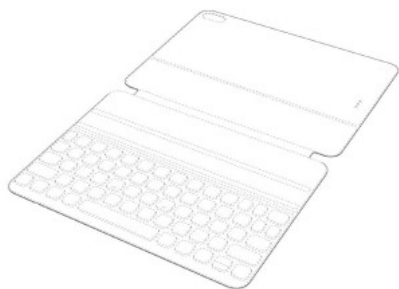

[11] 1900087.4

[15] 14-01-2019

[51] Cl. 11-01

[54] 搖擺戒指

Swing ring

[73] SURANA BROTHERS IP HOLDINGS LIMITED

Unit 2, 11/F., Tower B,

Hung Hom Commercial Centre,

37 Ma Tau Wai Road, Hunghom, Kowloon, Hong Kong

[74] CHAN, TANG & KWOK

Rooms 2503-04, 25/F.,

Shanghai Industrial Investment Building,

48-62 Hennessy Road, Wanchai, Hong Kong.



[11] 1900089.8

[15] 14-01-2019

[51] Cl. 21-01

[54] 玩具槍

Toy gun

[73] Buzz Bee Toys (HK) Co., Limited
Units 1206-1208, Tower B, New Mandarin Plaza,
14 Science Museum Road, Tsim Sha Tsui East,
Kowloon, Hong Kong

[74] INCOMPASS IP LIMITED
532B, 5/F, Core Building 2, Phase One,
Hong Kong Science Park, Pak Shek Kok, HONG KONG
HONG KONG



[11] 1900090.0

[15] 14-01-2019

[51] Cl. 21-01

[54] 玩具槍的彈夾

Magazine for toy gun

[73] Buzz Bee Toys (HK) Co., Limited
Units 1206-1208, Tower B, New Mandarin Plaza,
14 Science Museum Road, Tsim Sha Tsui East,
Kowloon, Hong Kong

[74] INCOMPASS IP LIMITED
532B, 5/F, Core Building 2, Phase One,
Hong Kong Science Park, Pak Shek Kok, HONG KONG
HONG KONG



[11] 1900091.2M001

[15] 14-01-2019

[51] Cl. 21-01

[54] 玩具麥克風

Toy microphone

[73] Gealex Toys Manufacturing Co. Ltd.

Blocks C & D, 6/F., Kwai Po Industrial Building,

40 Wong Chuk Hang Road, Aberdeen,

Hong Kong

[74] BENNY KONG & TSAI

Unit 19B, Overseas Trust Bank Building,

No. 160 Gloucester Road,

Wanchai, Hong Kong.



[11] 1900091.2M002

[15] 14-01-2019

[51] Cl. 21-01

[54] 玩具麥克風

Toy microphone

[73] Gealex Toys Manufacturing Co. Ltd.

Blocks C & D, 6/F., Kwai Po Industrial Building,

40 Wong Chuk Hang Road, Aberdeen,

Hong Kong

[74] BENNY KONG & TSAI

Unit 19B, Overseas Trust Bank Building,

No. 160 Gloucester Road,

Wanchai, Hong Kong.



[11] 1900111.6M001

[15] 18-01-2019

[51] Cl. 16-06

[54] 太陽眼鏡

Sunglasses

[73] CHRISTIAN DIOR COUTURE

30 Avenue Montaigne,

75008 Paris,

FRANCE

[74] Wilkinson & Grist

6th Floor, Prince's Building,

Chater Road,

Hong Kong.



[11] 1900111.6M002

[15] 18-01-2019

[51] Cl. 16-06

[54] 太陽眼鏡

Sunglasses

[73] CHRISTIAN DIOR COUTURE

30 Avenue Montaigne,
75008 Paris,
FRANCE

[74] Wilkinson & Grist

6th Floor, Prince's Building,
Chater Road,
Hong Kong.



[11] 1900113.0M001

[15] 18-01-2019

[30] 20-07-2018 / JP / 015974 of 2018

[51] Cl. 28-03

[54] 按摩器

Massage apparatus

[73] 株式會社 MTG

MTG Co., Ltd.

32, HONJIN-DORI 2-CHOME, NAKAMURA-KU,
NAGOYA-SHI, AICHI-KEN 453-0041,
JAPAN

[74] CHINAHONGKONG IP LIMITED

3011, 30/F, Office Tower,
Convention Plaza, 1 Harbour Road,
Hong Kong.

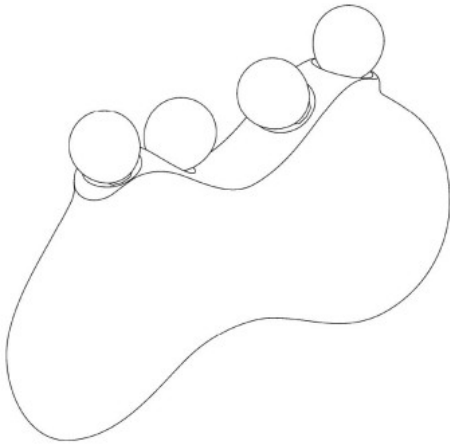

[11] 1900113.0M002

[15] 18-01-2019

[30] 20-07-2018 / JP / 015973 of 2018

[51] Cl. 28-03

[54] 按摩器

Massage apparatus

[73] 株式會社 MTG

MTG Co., Ltd.

32, HONJIN-DORI 2-CHOME, NAKAMURA-KU,

NAGOYA-SHI, AICHI-KEN 453-0041,

JAPAN

[74] CHINAHONGKONG IP LIMITED

3011, 30/F, Office Tower,

Convention Plaza, 1 Harbour Road,

Hong Kong.

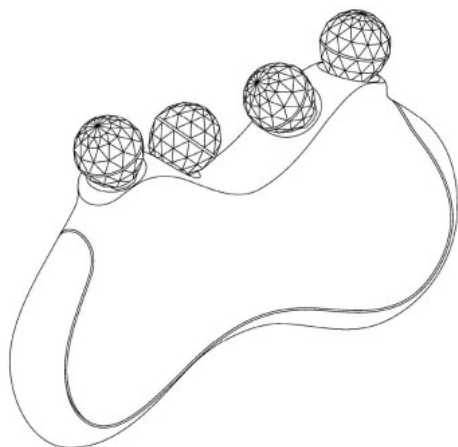

[11] 1900113.0M003

- [15] 18-01-2019
- [30] 14-09-2018 / JP / 020083 of 2018
- [51] Cl. 28-03
- [54] 按摩器
Massage apparatus
- [73] 株式會社 MTG
MTG Co., Ltd.
32, HONJIN-DORI 2-CHOME, NAKAMURA-KU,
NAGOYA-SHI, AICHI-KEN 453-0041,
JAPAN
- [74] CHINAHONGKONG IP LIMITED
3011, 30/F, Office Tower,
Convention Plaza, 1 Harbour Road,
Hong Kong.

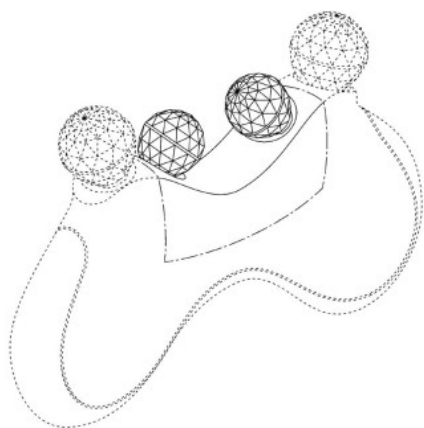

-
- [11] 1900122.9M001
- [15] 18-01-2019
- [30] 19-07-2018 / US / 29/657,170
- [51] Cl. 11-01
- [54] 手鐲
Bracelet
- [73] Michal Kadar LLC d/b/a Cadar
595 Madison Ave., 5th floor,
New York, NY 10022,
UNITED STATES
- [74] CHINAHONGKONG PATENT LIMITED
3012, 30/F, Office Tower,
Convention Plaza, 1 Harbour Road,
Hong Kong.



[11] 1900122.9M002

[15] 18-01-2019

[30] 19-07-2018 / US / 29/657,170

[51] Cl. 11-01

[54] 手鐲

Bracelet

[73] Michal Kadar LLC d/b/a Cadar
595 Madison Ave., 5th floor,
New York, NY 10022,
UNITED STATES

[74] CHINAHONGKONG PATENT LIMITED
3012, 30/F, Office Tower,
Convention Plaza, 1 Harbour Road,
Hong Kong.



- [11] 1900122.9M003
[15] 18-01-2019
[30] 19-07-2018 / US / 29/657,174
[51] Cl. 11-01
[54] 手鐲
Bracelet
[73] Michal Kadar LLC d/b/a Cadar
595 Madison Ave., 5th floor,
New York, NY 10022,
UNITED STATES
[74] CHINAHONGKONG PATENT LIMITED
3012, 30/F, Office Tower,
Convention Plaza, 1 Harbour Road,
Hong Kong.



-
- [11] 1900122.9M004
[15] 18-01-2019
[30] 19-07-2018 / US / 29/657,174
[51] Cl. 11-01
[54] 手鐲
Bracelet
[73] Michal Kadar LLC d/b/a Cadar
595 Madison Ave., 5th floor,
New York, NY 10022,
UNITED STATES
[74] CHINAHONGKONG PATENT LIMITED
3012, 30/F, Office Tower,
Convention Plaza, 1 Harbour Road,
Hong Kong.



[11] 1900124.3M001

[15] 18-01-2019

[30] 19-07-2018 / US / 29/657,165

[51] Cl. 11-01

[54] 戒指
Ring

[73] Michal Kadar LLC d/b/a Cadar
595 Madison Ave., 5th floor,
New York, NY 10022,
UNITED STATES

[74] CHINAHONGKONG PATENT LIMITED
3012, 30/F, Office Tower,
Convention Plaza, 1 Harbour Road,
Hong Kong.



- [11] 1900124.3M002
[15] 18-01-2019
[30] 19-07-2018 / US / 29/657,167
[51] Cl. 11-01
[54] 戒指
Ring
[73] Michal Kadar LLC d/b/a Cadar
595 Madison Ave., 5th floor,
New York, NY 10022,
UNITED STATES
[74] CHINAHONGKONG PATENT LIMITED
3012, 30/F, Office Tower,
Convention Plaza, 1 Harbour Road,
Hong Kong.



-
- [11] 1900125.6
[15] 19-01-2019
[51] Cl. 11-02
[54] 垂直綠牆容器
Vertical green wall container
[73] 李淑慧
Li Shuk Wai
Flat 2B, Parkford Garden,
6 Chi Fuk Circuit, Fanling,
NT, Hong Kong
香港新界粉嶺 置福
圍 6 號 百福花園 2
樓 B 室
[74] Hong Kong Trademark & Design Protection Agency Ltd.
Room 2802, 28/F.,

Lippo Centre Tower 2,
89 Queensway, Hong Kong.

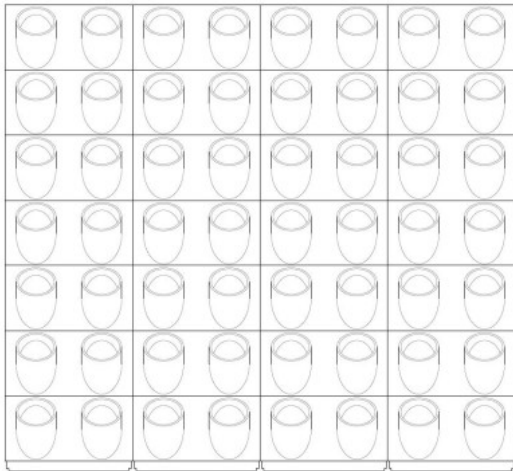

[11] 1900135.7

[15] 22-01-2019

[51] Cl. 3-01

[54] 海象形背包

Walrus shaped backpack

[73] Morn Creations Limited G/F,
No. 117 Apliu Street,
Sham Shui Po, Kowloon
Hong Kong

[74] Morn Creations Limited G/F,
No. 117 Apliu Street,
Sham Shui Po, Kowloon
Hong Kong



[11] 1900136.9

[15] 22-01-2019

[51] Cl. 3-01

[54] 蝠鱝形背包

Manta ray shaped backpack

[73] Morn Creations Limited G/F,
No. 117 Apliu Street,
Sham Shui Po, Kowloon
Hong Kong

[74] Morn Creations Limited G/F,
No. 117 Apliu Street,
Sham Shui Po, Kowloon
Hong Kong



[11] 1900146.0

[15] 22-01-2019

[30] 30-07-2018 / CN / 201830415187.0

[51] Cl. 3-04

[54] 風扇

Fan

[73] 深圳市同創創精密電子有限公司
中國內地深圳市 寶安區西鄉街
道三圍
華豐第一科技園 B 區一棟三樓、八樓北

[74] 金信智權有限公司
香港觀塘
偉業街 221 號
美德工業大廈 D 座 10/F 38 室

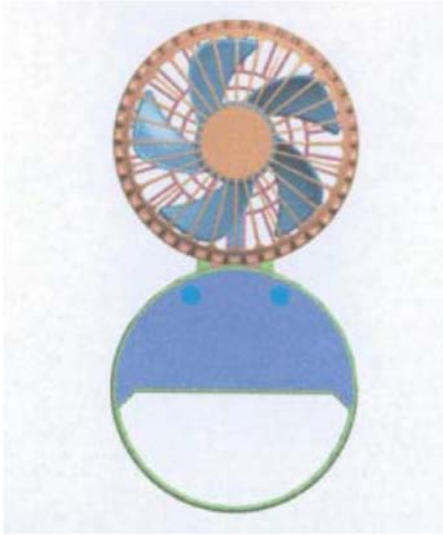

[11] 1900148.4

[15] 23-01-2019

[30] 21-01-2019 / EU / 006079711-0017

[51] Cl. 21-01

[54] 玩具機械人

Toy robot

[73] 銀輝號有限公司

SILVERLIT LIMITED

Room 1704, World Trade Centre,

280 Gloucester Road, Causeway Bay

Hong Kong

[74] SILVERLIT LIMITED

Room 1704, World Trade Centre,

280 Gloucester Road, Causeway Bay

Hong Kong

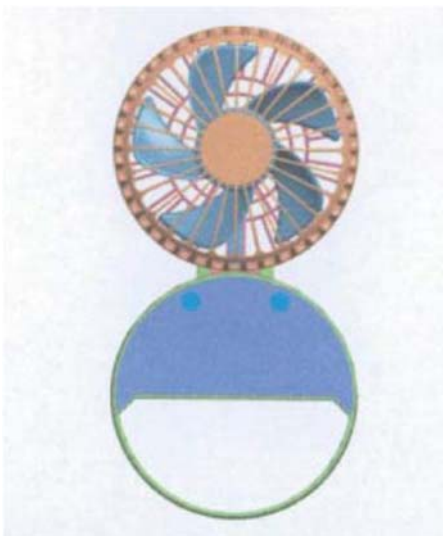

- [11] 1900151.0
[15] 23-01-2019
[30] 18-01-2019 / EU, MC, NO, SG, GB, US / WIPO79401
[51] Cl. 11-01
[54] 耳環
Earrings
[73] PROJECT LOUD FRANCE
24/32 rue Jean Goujon,
75008 Paris,
FRANCE
[74] Wilkinson & Grist
6th Floor, Prince's Building,
Chater Road,
Hong Kong.



-
- [11] 1900153.4
[15] 23-01-2019
[30] 24-07-2018 / EU, MA, SG, CH, TR / DM/102 340
[51] Cl. 3-01
[54] 手提包
Handbag
[73] CARTIER INTERNATIONAL AG
Hinterbergstrasse 22,
6312 Steinhausen,
SWITZERLAND
[74] WENPING & CO.
1701 Tung Wai Commercial Building,
111 Gloucester Road,
Hong Kong.



[11] 1900157.3

[15] 24-01-2019

[51] Cl. 9-01

[54] 包裝用容器

Packaging container

[73] KRACIE HOME PRODUCTS, LTD.

20-20, Kaigan 3-chome,
Minato-ku, 108-0022, Tokyo,
JAPAN

[74] UNION PATENT SERVICE CENTRE

Units E-F, 20th Floor, Neich Tower,
128 Gloucester Road,
Hong Kong.



[11] 1900158.5

[15] 24-01-2019

[51] Cl. 9-05

[54] 包裝用袋

Packaging bag

[73] KRACIE HOME PRODUCTS, LTD.

20-20, Kaigan 3-chome,
Minato-ku, 108-0022, Tokyo,
JAPAN

[74] UNION PATENT SERVICE CENTRE

Units E-F, 20th Floor, Neich Tower,
128 Gloucester Road,
Hong Kong.



[11] 1900159.7

[15] 24-01-2019

[51] Cl. 9-01

[54] 包裝用容器

Packaging container

[73] KRACIE HOME PRODUCTS, LTD.

20-20, Kaigan 3-chome,
Minato-ku, 108-0022, Tokyo,
JAPAN

[74] UNION PATENT SERVICE CENTRE

Units E-F, 20th Floor, Neich Tower,
128 Gloucester Road,
Hong Kong.

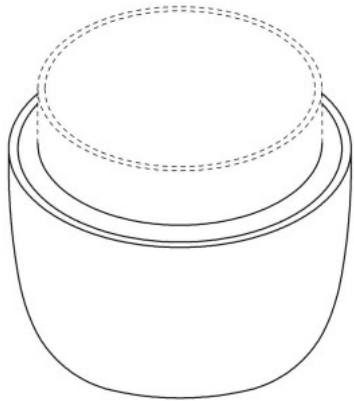

[11] 1900160.9

[15] 24-01-2019

[51] Cl. 9-05

[54] 包裝用容器

Packaging container

[73] KRACIE HOME PRODUCTS, LTD.

20-20, Kaigan 3-chome,
Minato-ku, 108-0022, Tokyo,
JAPAN

[74] UNION PATENT SERVICE CENTRE

Units E-F, 20th Floor, Neich Tower,
128 Gloucester Road,
Hong Kong.



[11] 1900161.1

[15] 24-01-2019

[51] Cl. 9-01

[54] 包裝用容器

Packaging container

[73] KRACIE HOME PRODUCTS, LTD.

20-20, Kaigan 3-chome,
Minato-ku, 108-0022, Tokyo,
JAPAN

[74] UNION PATENT SERVICE CENTRE

Units E-F, 20th Floor, Neich Tower,
128 Gloucester Road,
Hong Kong.



[11] 1900162.3

[15] 24-01-2019

[51] Cl. 10-06

[54] 緊急信號標誌

Emergency signalling signage

[73] Horticom Services Pty Ltd

PO Box 131 Ballina,
NSW, 2478
Australia

[74] Luo & Jia Intellectual Property Limited

9B, Cheong Tai Commercial Building,
66 Wing Lok Street, Sheung Wan
Hong Kong



[11] 1900165.0

[15] 24-01-2019

[30] 26-07-2018 / TH / 1802003051

[51] Cl. 10-05

[54] 溫度感應器

Temperature sensor

[73] DAIKIN INDUSTRIES (Thailand) LTD.

700/11, Amata Nakorn Industrial Estate, Bangna-Trad Road., Km.
57, Tambol Klontamru Ampure Muang, Chonburi, 20000, THAILAND

Daikin Kohgyo Kabushiki Gaisha (Daikin Industries Ltd.)

Umeda Center Building, Umeda Center Building, 4-12 Nakazaki
Nakazaki Nakazaki-Nishi 2-chome, Kita-ku, Osaka-shi, Osaka-fu
Japan

[74] MARKS & CLERK

Level 9, Cyberport 1, 100 Cyberport Road, Pok Fu Lam, Hong
Kong.

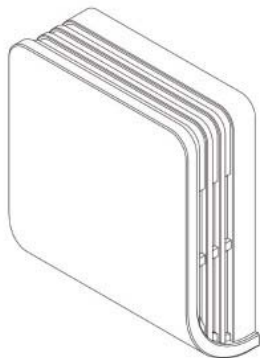

[11] 1900166.2

[15] 24-01-2019

[30] 29-11-2018 / CN / 201830684287.3

[51] Cl. 26-04

[54] 帶有激光指示器的筆形發光二極管燈

Pen shaped LED lamp with laser pointer

[73] 上海智匯電器有限公司

AEC Lighting Solutions Co., Ltd

中國內地上海市嘉定區

馬陸鎮寶安公路 2548 號

郵編 201801

- [74] 中港專利有限公司
香港
港灣道 1 號
會展廣場辦公大樓 30 樓 3012 室



-
- [11] 1900167.4M001
[15] 24-01-2019
[30] 13-08-2018 / US / 29/659,800
[51] Cl. 7-01
[54] 碗
Bowl
[73] DART INDUSTRIES INC.
14901 S. Orange Blossom Trail,
Orlando, Florida 32837,
UNITED STATES
[74] Wilkinson & Grist
6th Floor, Prince's Building,
Chater Road,
Hong Kong.

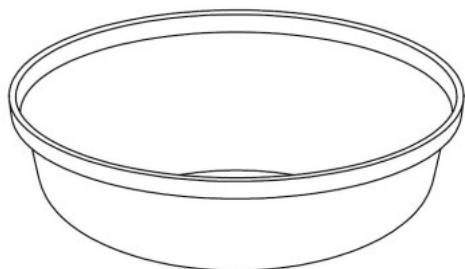

-
- [11] 1900167.4M002
[15] 24-01-2019

[30] 13-08-2018 / US / 29/659,800

[51] Cl. 7-01

[54] 碗

Bowl

[73] DART INDUSTRIES INC.

14901 S. Orange Blossom Trail,
Orlando, Florida 32837,
UNITED STATES

[74] Wilkinson & Grist

6th Floor, Prince's Building,
Chater Road,
Hong Kong.

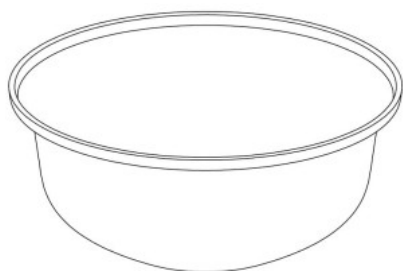

[11] 1900167.4M003

[15] 24-01-2019

[30] 13-08-2018 / US / 29/659,800

[51] Cl. 7-01

[54] 碗

Bowl

[73] DART INDUSTRIES INC.

14901 S. Orange Blossom Trail,
Orlando, Florida 32837,
UNITED STATES

[74] Wilkinson & Grist

6th Floor, Prince's Building,
Chater Road,
Hong Kong.

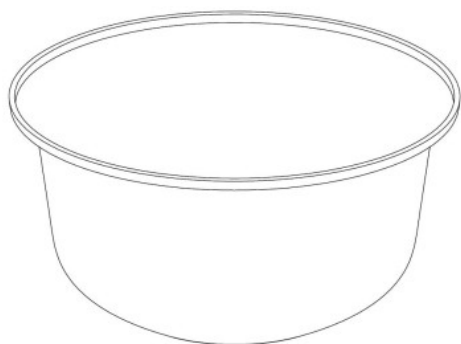

[11] 1900168.6

[15] 24-01-2019

[30] 13-08-2018 / US / 29/659,802

[51] Cl. 9-07

[54] 用於碗的密封蓋

Seal for bowl

[73] DART INDUSTRIES INC.

14901 S. Orange Blossom Trail,

Orlando, Florida 32837,

UNITED STATES

[74] Wilkinson & Grist

6th Floor, Prince's Building,

Chater Road,

Hong Kong.

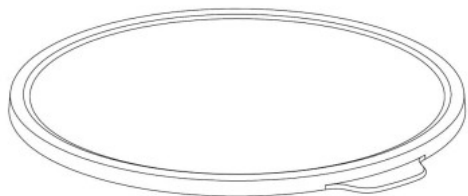

[11] 1900169.8

[15] 25-01-2019

[30] 26-07-2018 / EU / 005515632

[51] Cl. 12-08

[54] 車

Car

[73] FERRARI S.p.A.

VIA EMILIA EST 1163 I-41100 MODENA,

ITALY

[74] China Patent Agent (H.K.) Ltd.

22/F, Great Eagle Centre,

23 Harbour Road,

Wanchai, Hong Kong.

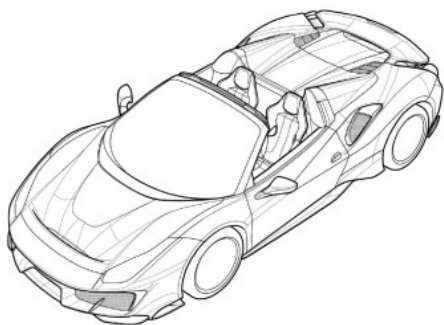

[11] 1900170.0

[15] 25-01-2019

[30] 26-07-2018 / EM / 005515392

[51] Cl. 21-01

[54] 玩具車

Toy car

[73] FERRARI S.p.A.

VIA EMILIA EST 1163 I-41100 MODENA,
ITALY

[74] China Patent Agent (H.K.) Ltd.

22/F, Great Eagle Centre,
23 Harbour Road,
Wanchai, Hong Kong.

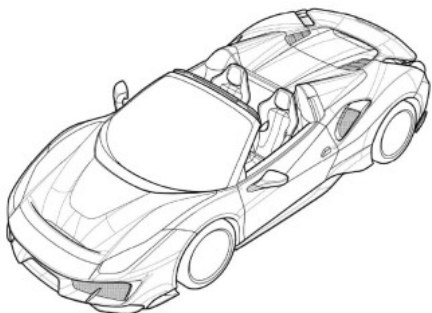

[11] 1900171.2M001

[15] 25-01-2019

[30] 16-08-2018 / EU / 005609344-0001

[51] Cl. 23-04

[54] 空氣淨化器

Air purifier

[73] Dyson Technology Limited

Tetbury Hill, Malmesbury,
Wiltshire, SN16 0RP,
UNITED KINGDOM

[74] Liu, Shen & Associates
Room 3716, 37th Floor,
Sun Hung Kai Centre,
30 Harbour Road, Wanchai, Hong Kong.

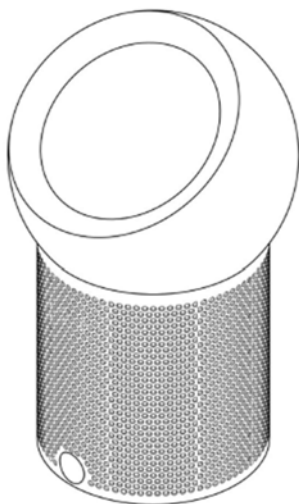

[11] 1900171.2M002

[15] 25-01-2019

[30] 16-08-2018 / EU / 005609344-0002

[51] Cl. 23-04

[54] 空氣淨化器

Air purifier

[73] Dyson Technology Limited
Tetbury Hill, Malmesbury,
Wiltshire, SN16 0RP,
UNITED KINGDOM

[74] Liu, Shen & Associates
Room 3716, 37th Floor,
Sun Hung Kai Centre,
30 Harbour Road, Wanchai, Hong Kong.

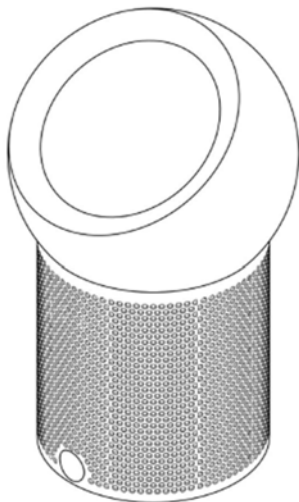

[11] 1900171.2M003

[15] 25-01-2019

[30] 16-08-2018 / EU / 005609344-0003

[51] Cl. 23-04

[54] 空氣淨化器

Air purifier

[73] Dyson Technology Limited
Tetbury Hill, Malmesbury,
Wiltshire, SN16 0RP,
UNITED KINGDOM

[74] Liu, Shen & Associates
Room 3716, 37th Floor,
Sun Hung Kai Centre,
30 Harbour Road, Wanchai, Hong Kong.

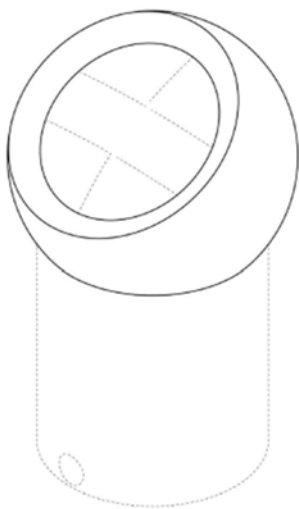

- [11] 1900171.2M004
[15] 25-01-2019
[30] 16-08-2018 / EU / 005609369-0001
[51] Cl. 23-04
[54] 空氣淨化器
Air purifier
[73] Dyson Technology Limited
Tetbury Hill, Malmesbury,
Wiltshire, SN16 0RP,
UNITED KINGDOM
[74] Liu, Shen & Associates
Room 3716, 37th Floor,
Sun Hung Kai Centre,
30 Harbour Road, Wanchai, Hong Kong.

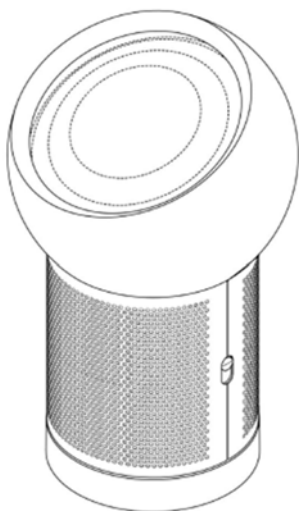

-
- [11] 1900172.4M001
[15] 25-01-2019
[30] 16-08-2018 / EM / 005610326-0001
[51] Cl. 28-03
[54] 頭髮造型和頭髮護理裝置
Hair styling and hair care apparatus
[73] Dyson Technology Limited
Tetbury Hill, Malmesbury,
Wiltshire, SN16 0RP,
UNITED KINGDOM
[74] Liu, Shen & Associates
Room 3716, 37th Floor,
Sun Hung Kai Centre,
30 Harbour Road, Wanchai, Hong Kong.

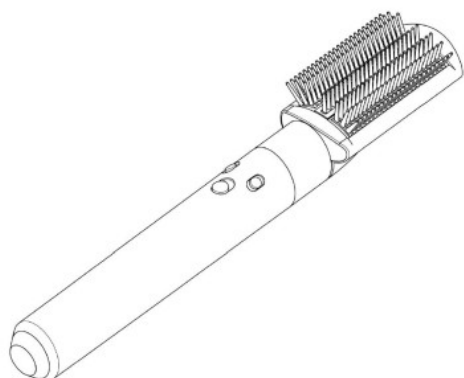

[11] 1900172.4M002

[15] 25-01-2019

[30] 16-08-2018 / EM / 005610326-0002

[51] Cl. 28-03

[54] 頭髮造型和頭髮護理裝置

Hair styling and hair care apparatus

[73] Dyson Technology Limited
Tetbury Hill, Malmesbury,
Wiltshire, SN16 0RP,
UNITED KINGDOM

[74] Liu, Shen & Associates
Room 3716, 37th Floor,
Sun Hung Kai Centre,
30 Harbour Road, Wanchai, Hong Kong.

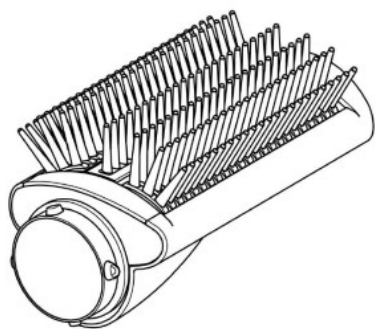

[11] 1900172.4M003

[15] 25-01-2019

[30] 16-08-2018 / EM / 005610334-0001

[51] Cl. 28-03

- [54] 頭髮造型和頭髮護理裝置
Hair styling and hair care apparatus
- [73] Dyson Technology Limited
Tetbury Hill, Malmesbury,
Wiltshire, SN16 0RP,
UNITED KINGDOM
- [74] Liu, Shen & Associates
Room 3716, 37th Floor,
Sun Hung Kai Centre,
30 Harbour Road, Wanchai, Hong Kong.

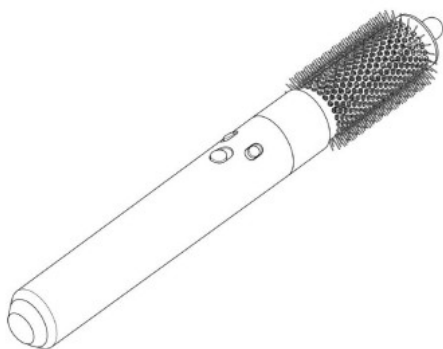

-
- [11] 1900172.4M004
- [15] 25-01-2019
- [30] 16-08-2018 / EM / 005610334-0002
- [51] Cl. 28-03
- [54] 頭髮造型和頭髮護理裝置
Hair styling and hair care apparatus
- [73] Dyson Technology Limited
Tetbury Hill, Malmesbury,
Wiltshire, SN16 0RP,
UNITED KINGDOM
- [74] Liu, Shen & Associates
Room 3716, 37th Floor,
Sun Hung Kai Centre,
30 Harbour Road, Wanchai, Hong Kong.

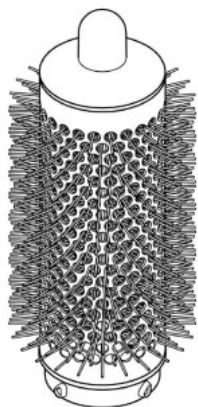

[11] 1900173.6

[15] 25-01-2019

[51] Cl. 21-01

[54] 投杯球遊戲桌

Beer pong gaming table

[73] Atalon IP limited

Room G, 29/F, Monterey Plaza,
15 Chong Yip Street, Kwun Tong,
Kowloon, Hong Kong

[74] Global Intellectual Property Company Limited

Unit 2205, 22/F, Sino Plaza,
255-257 Gloucester Road,
Causeway Bay, Hong Kong.

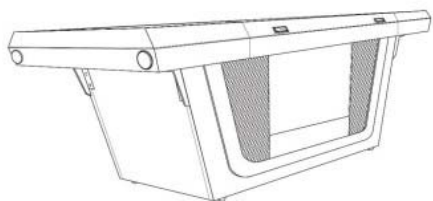

[11] 1900174.8

[15] 25-01-2019

[30] 07-08-2018 / KR / 30-2018-0036561

[51] Cl. 7-01

[54] 用完即棄杯的蓋

Lid for disposable cup

[73] Grip At Co., Ltd.
#104-904, 34, Sanhyeon-ro, Ilsanseo-gu,
Goyang-si, Gyeonggi-do,
KOREA, REPUBLIC OF

[74] WENPING & CO.
1701 Tung Wai Commercial Building,
111 Gloucester Road,
Hong Kong.

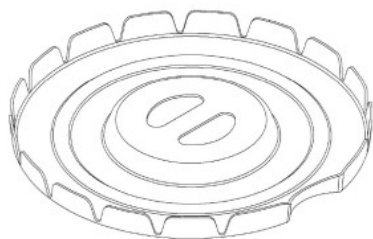

[11] 1900175.1

[15] 25-01-2019

[30] 05-10-2018 / KR / 30-2018-0045900

[51] Cl. 7-01

[54] 用完即棄杯的蓋

Lid for disposable cup

[73] Grip At Co., Ltd.
#104-904, 34, Sanhyeon-ro, Ilsanseo-gu,
Goyang-si, Gyeonggi-do,
KOREA, REPUBLIC OF

[74] WENPING & CO.
1701 Tung Wai Commercial Building,
111 Gloucester Road,
Hong Kong.

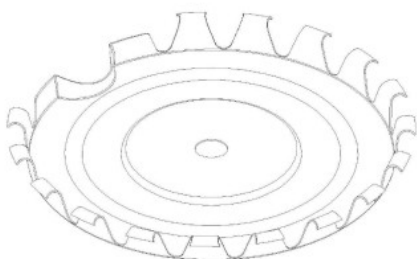

- [11] 1900179.9M001
[15] 25-01-2019
[30] 27-07-2018 / JP / 016466 of 2018
[51] Cl. 15-07
[54] 冰箱
Refrigerator
[73] Hoshizaki Corporation
3-16 Minamiyakata, Sakae-cho,
Toyoake-shi, Aichi,
JAPAN
[74] EMILY YIP & CO
1st Floor, Kingsfield Centre,
18 Shell Street, Fortress Hill,
Hong Kong.

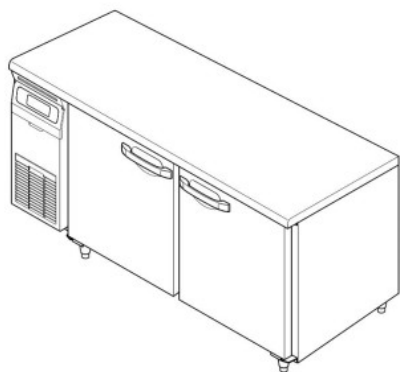

-
- [11] 1900179.9M002
[15] 25-01-2019
[30] 27-07-2018 / JP / 016467 of 2018
[51] Cl. 15-07
[54] 冰箱
Refrigerator
[73] Hoshizaki Corporation
3-16 Minamiyakata, Sakae-cho,
Toyoake-shi, Aichi,
JAPAN
[74] EMILY YIP & CO
1st Floor, Kingsfield Centre,
18 Shell Street, Fortress Hill,
Hong Kong.

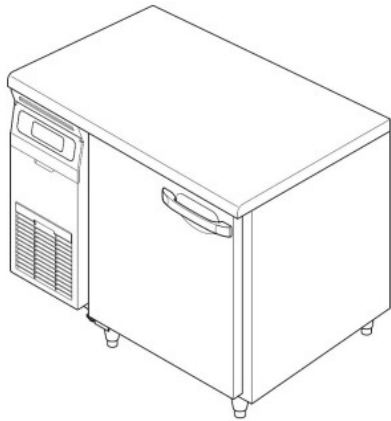

[11] 1900179.9M003

[15] 25-01-2019

[30] 27-07-2018 / JP / 016469 of 2018

[51] Cl. 15-07

[54] 冰箱

Refrigerator

[73] Hoshizaki Corporation
3-16 Minamiyakata, Sakae-cho,
Toyoake-shi, Aichi,
JAPAN

[74] EMILY YIP & CO
1st Floor, Kingsfield Centre,
18 Shell Street, Fortress Hill,
Hong Kong.



[11] 1900179.9M004

[15] 25-01-2019

[30] 28-09-2018 / JP / 021172 of 2018

[51] Cl. 15-07

[54] 冰箱

Refrigerator

[73] Hoshizaki Corporation

3-16 Minamiyakata, Sakae-cho,

Toyoake-shi, Aichi,

JAPAN

[74] EMILY YIP & CO

1st Floor, Kingsfield Centre,

18 Shell Street, Fortress Hill,

Hong Kong.

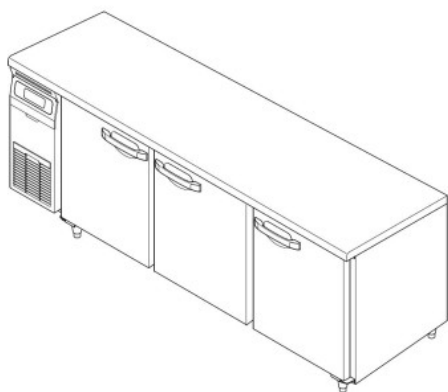

[11] 1900180.1M001

[15] 28-01-2019

[51] Cl. 11-01

[54] 飾物設計

Ornament design

[73] 金至尊國際有限公司

3D-GOLD INTERNATIONAL COMPANY LIMITED

UNITS 01-09, 17TH FLOOR,

PENINSULA SQUARE, NO.18 SUNG ON STREET,

HUNGHOM, KOWLOON, HONG KONG

[74] 3D-GOLD INTERNATIONAL COMPANY LIMITED (ATTENTION TO IRENE CHEUNG)

UNITS 01-09, 17TH FLOOR,

PENINSULA SQUARE, NO.18 SUNG ON STREET,

HUNGHOM, KOWLOON, HONG KONG



[11] 1900180.1M002

[15] 28-01-2019

[51] Cl. 11-01

[54] 飾物設計

Ornament design

[73] 金至尊國際有限公司

3D-GOLD INTERNATIONAL COMPANY LIMITED
UNITS 01-09, 17TH FLOOR,
PENINSULA SQUARE, NO.18 SUNG ON STREET,
HUNGHOM, KOWLOON, HONG KONG

[74] 3D-GOLD INTERNATIONAL COMPANY LIMITED (ATTENTION TO IRENE
CHEUNG)

UNITS 01-09, 17TH FLOOR,
PENINSULA SQUARE, NO.18 SUNG ON STREET,
HUNGHOM, KOWLOON, HONG KONG



[11] 1900180.1M003

[15] 28-01-2019

[51] Cl. 11-01

[54] 飾物設計

Ornament design

[73] 金至尊國際有限公司

3D-GOLD INTERNATIONAL COMPANY LIMITED
UNITS 01-09, 17TH FLOOR,
PENINSULA SQUARE, NO.18 SUNG ON STREET,
HUNGHOM, KOWLOON, HONG KONG

[74] 3D-GOLD INTERNATIONAL COMPANY LIMITED (ATTENTION TO IRENE
CHEUNG)

UNITS 01-09, 17TH FLOOR,
PENINSULA SQUARE, NO.18 SUNG ON STREET,
HUNGHOM, KOWLOON, HONG KONG



[11] 1900180.1M004

[15] 28-01-2019

[51] Cl. 11-01

[54] 飾物設計

Ornament design

[73] 金至尊國際有限公司

3D-GOLD INTERNATIONAL COMPANY LIMITED
UNITS 01-09, 17TH FLOOR,
PENINSULA SQUARE, NO.18 SUNG ON STREET,
HUNGHOM, KOWLOON, HONG KONG

[74] 3D-GOLD INTERNATIONAL COMPANY LIMITED (ATTENTION TO IRENE
CHEUNG)

UNITS 01-09, 17TH FLOOR,
PENINSULA SQUARE, NO.18 SUNG ON STREET,
HUNGHOM, KOWLOON, HONG KONG



[11] 1900180.1M005

[15] 28-01-2019

[51] Cl. 11-01

[54] 飾物設計

Ornament design

[73] 金至尊國際有限公司

3D-GOLD INTERNATIONAL COMPANY LIMITED
UNITS 01-09, 17TH FLOOR,
PENINSULA SQUARE, NO.18 SUNG ON STREET,
HUNGHOM, KOWLOON, HONG KONG

[74] 3D-GOLD INTERNATIONAL COMPANY LIMITED (ATTENTION TO IRENE
CHEUNG)

UNITS 01-09, 17TH FLOOR,
PENINSULA SQUARE, NO.18 SUNG ON STREET,
HUNGHOM, KOWLOON, HONG KONG



[11] 1900180.1M006

[15] 28-01-2019

[51] Cl. 11-01

[54] 飾物設計

Ornament design

[73] 金至尊國際有限公司

3D-GOLD INTERNATIONAL COMPANY LIMITED
UNITS 01-09, 17TH FLOOR,
PENINSULA SQUARE, NO.18 SUNG ON STREET,
HUNGHOM, KOWLOON, HONG KONG

[74] 3D-GOLD INTERNATIONAL COMPANY LIMITED (ATTENTION TO IRENE
CHEUNG)

UNITS 01-09, 17TH FLOOR,
PENINSULA SQUARE, NO.18 SUNG ON STREET,
HUNGHOM, KOWLOON, HONG KONG



[11] 1900180.1M007

[15] 28-01-2019

[51] Cl. 11-01

[54] 飾物設計

Ornament design

[73] 金至尊國際有限公司

3D-GOLD INTERNATIONAL COMPANY LIMITED
UNITS 01-09, 17TH FLOOR,
PENINSULA SQUARE, NO.18 SUNG ON STREET,
HUNGHOM, KOWLOON, HONG KONG

[74] 3D-GOLD INTERNATIONAL COMPANY LIMITED (ATTENTION TO IRENE
CHEUNG)

UNITS 01-09, 17TH FLOOR,
PENINSULA SQUARE, NO.18 SUNG ON STREET,
HUNGHOM, KOWLOON, HONG KONG



[11] 1900180.1M008

[15] 28-01-2019

[51] Cl. 11-01

[54] 飾物設計

Ornament design

[73] 金至尊國際有限公司

3D-GOLD INTERNATIONAL COMPANY LIMITED
UNITS 01-09, 17TH FLOOR,
PENINSULA SQUARE, NO.18 SUNG ON STREET,
HUNGHOM, KOWLOON, HONG KONG

[74] 3D-GOLD INTERNATIONAL COMPANY LIMITED (ATTENTION TO IRENE
CHEUNG)

UNITS 01-09, 17TH FLOOR,
PENINSULA SQUARE, NO.18 SUNG ON STREET,
HUNGHOM, KOWLOON, HONG KONG



[11] 1900180.1M009

[15] 28-01-2019

[51] Cl. 11-01

[54] 飾物設計

Ornament design

[73] 金至尊國際有限公司

3D-GOLD INTERNATIONAL COMPANY LIMITED
UNITS 01-09, 17TH FLOOR,
PENINSULA SQUARE, NO.18 SUNG ON STREET,
HUNGHOM, KOWLOON, HONG KONG

[74] 3D-GOLD INTERNATIONAL COMPANY LIMITED (ATTENTION TO IRENE
CHEUNG)

UNITS 01-09, 17TH FLOOR,
PENINSULA SQUARE, NO.18 SUNG ON STREET,
HUNGHOM, KOWLOON, HONG KONG

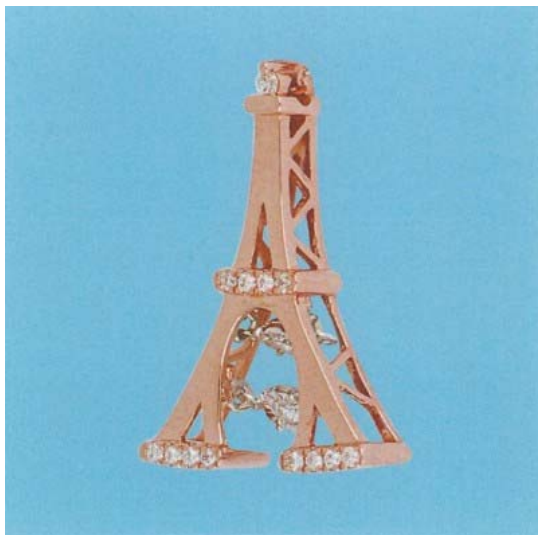

[11] 1900180.1M010

[15] 28-01-2019

[51] Cl. 11-01

[54] 飾物設計

Ornament design

[73] 金至尊國際有限公司

3D-GOLD INTERNATIONAL COMPANY LIMITED
UNITS 01-09, 17TH FLOOR,
PENINSULA SQUARE, NO.18 SUNG ON STREET,
HUNGHOM, KOWLOON, HONG KONG

[74] 3D-GOLD INTERNATIONAL COMPANY LIMITED (ATTENTION TO IRENE
CHEUNG)

UNITS 01-09, 17TH FLOOR,
PENINSULA SQUARE, NO.18 SUNG ON STREET,
HUNGHOM, KOWLOON, HONG KONG



[11] 1900182.5

[15] 28-01-2019

[30] 30-07-2018 / US / 29/658,335

[51] Cl. 14-01

[54] 耳機

Headphone

[73] Skullcandy, Inc.

6301 N. Landmark Dr. Park City,
UT 84098,
UNITED STATES

[74] CLT Patent & Trademark (H.K.) Ltd.

Unit 09, 34/F., Office Tower,
Convention Plaza, No. 1 Harbour Road,
Wanchai, Hong Kong.

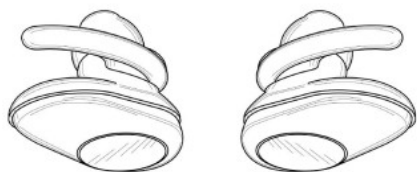

[11] 1900185.2M001

[15] 28-01-2019

[30] 27-11-2018 / EU / 005835238

[51] Cl. 19-06

[54] 書寫工具

Writing instrument

[73] Schneider Schreibgeräte GmbH
Schwarzenbach 9,
78144 Schramberg,
GERMANY

[74] Wilkinson & Grist
6th Floor, Prince's Building,
Chater Road,
Hong Kong.



[11] 1900185.2M002

[15] 28-01-2019

[30] 27-11-2018 / EU / 005835238

[51] Cl. 19-06

[54] 書寫工具連帽蓋

Writing instrument with cap

[73] Schneider Schreibgeräte GmbH
Schwarzenbach 9, 78144 Schramberg, GERMANY

[74] Wilkinson & Grist
6th Floor, Prince's Building, Chater Road, Hong Kong.



[11] 1900185.2M003

[15] 28-01-2019

[30] 27-11-2018 / EU / 005835238

[51] Cl. 19-06

[54] 書寫用具的帽蓋

Cap for writing instrument

[73] Schneider Schreibgeräte GmbH
Schwarzenbach 9, 78144 Schramberg, GERMANY

[74] Wilkinson & Grist
6th Floor, Prince's Building, Chater Road, Hong Kong.



[11] 1900186.4M001

[15] 28-01-2019

[51] Cl. 2-04

[54] 鞋類物品

Footwear article

[73] David Fu

Room 2911, 29/F., Tower 2,
The Gateway, 25 Canton Road,
Tsim Sha Tsui, Kowloon, Hong Kong

[74] Letters & Thoo Limited

Suite 1008,
Prosperity Millennia Plaza,
663 King's Road, Quarry Bay, Hong Kong.



[11] 1900186.4M002

[15] 28-01-2019

[51] Cl. 2-04

[54] 鞋類物品

Footwear article

[73] David Fu

Room 2911, 29/F., Tower 2,
The Gateway, 25 Canton Road,
Tsim Sha Tsui, Kowloon, Hong Kong.

[74] Letters & Thoo Limited

Suite 1008,
Prosperity Millennia Plaza,
663 King's Road, Quarry Bay, Hong Kong.



[11] 1900186.4M003

[15] 28-01-2019

[51] Cl. 2-04

[54] 鞋類物品

Footwear article

[73] David Fu

Room 2911, 29/F., Tower 2,
The Gateway, 25 Canton Road,
Tsim Sha Tsui, Kowloon, Hong Kong.

[74] Letters & Thoo Limited

Suite 1008,
Prosperity Millennia Plaza,
663 King's Road, Quarry Bay, Hong Kong.



[11] 1900188.8

[15] 29-01-2019

[51] Cl. 10-02

[54] 手錶

Watch

[73] THUMM & CO LLC

330 W Market Street, Suite B,

Warren, Ohio 44481,
UNITED STATES

[74] Wilkinson & Grist
6th Floor, Prince's Building,
Chater Road,
Hong Kong.



[11] 1900189.0

[15] 29-01-2019

[30] 08-08-2018 / JP / 017411 of 2018

[51] Cl. 7-02

[54] 保溫調理鍋

Thermal insulated cooking pot

[73] TIGER CORPORATION

3-1, Hayami-cho,
Kadoma City, Osaka,
JAPAN

[74] CHINAHONGKONG PATENT LIMITED

3012, 30/F, Office Tower,
Convention Plaza, 1 Harbour Road,
Hong Kong.

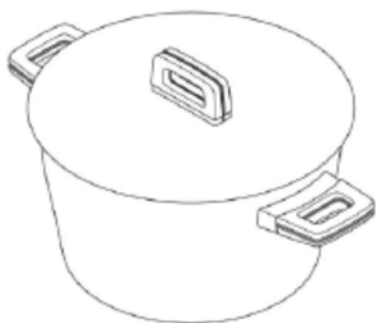



香港特別行政區政府知識產權署外觀設計註冊處

The Government of the Hong Kong Special Administrative Region

Designs Registry, Intellectual Property Department

根據註冊外觀設計條例第28條，下列註冊外觀設計因未繳續期費而停止有效。各組記項按註冊外觀設計停止有效日期及註冊編號先後次序排列。

Registered designs ceased through non-payment of renewal fees under section 28 of the Registered Designs Ordinance. Entries are listed below under their expiry dates.

29-06-2019 - 03-07-2019

29-06-2019	1401243.1M001
0901033.9	1401243.1M002
0901036.6M001	1401245.6
0901036.6M002	1401246.8
0901037.8	
0901039.2	03-07-2019
1401224.1	1401254.4M001
1401226.6	1401254.4M002
1401227.8	1401255.7
9910799.3	1401257.1
9910801.9	
9910802.1	

01-07-2019

0411448.6M001
0411448.6M002
0901045.5
1401237.9M001
1401237.9M002
1401237.9M003
1401237.9M004
1401237.9M005
1401237.9M006
1401237.9M007

02-07-2019

0901046.7
0901049.3
0901052.9
1401203.7
1401240.5
1401241.7
1401242.9M001
1401242.9M002



香港特別行政區政府知識產權署外觀設計註冊處

The Government of the Hong Kong Special Administrative Region

Designs Registry, Intellectual Property Department

根據註冊外觀設計規則第 31 條刪除的註冊外觀設計。各組記項按註冊外觀設計 刪除日期及註冊編號先後次序排列。

Registered designs removed under section 31 of the Registered Designs Rules. Entries are listed below under their removal dates.

06-07-2019 - 11-07-2019

06-07-2019

0803060.7M001
0803060.7M002
0803062.1
0803064.5M001
0803064.5M002

07-07-2019

0803070.8M001
0803071.0M001
0803071.0M002
1302321.7
1302324.3M001
1302324.3M002
1302325.6M002
1302325.6M004
1302325.6M006
1302325.6M008
1302325.6M009
1302325.6M010
1302326.8M002
1302326.8M004
1302326.8M005
1302326.8M006
1302326.8M007
1302326.8M008
1302326.8M010
1302327.0M002
1302327.0M004
1302327.0M005
1302327.0M006
1302327.0M008
1302327.0M010
1302329.4

08-07-2019

0312288.6
0312293.6M003
0803081.1
0803082.3
0803083.5
0803084.7
0803085.0
0803086.2
0803087.4
1302333.2
1302336.9

09-07-2019

0900003.5
1400002.0M001
1400002.0M002
1400002.0M003
1400003.2
1400007.1
1400008.3
1400009.5
1400010.7
1400011.9
1400012.1
1400013.3

11-07-2019

1400020.8
1400021.0
1400022.2
1400023.4
1400024.6

1400025.9



香港特別行政區政府知識產權署外觀設計註冊處

The Government of the Hong Kong Special Administrative Region

Designs Registry, Intellectual Property Department

根據註冊外觀設計條例第 67 及 76 條，更正註冊紀錄冊內及已提交文件中的錯誤

Correction of Errors in Register and in Filed Documents under sections 67 and 76 of the Registered Designs Ordinance

任何人士現可對下列更正錯誤的請求提出反對

Requests for correction of errors now open to opposition

如任何人士意欲反對下列請求，則須在本官方公報刊登是項更正請求的日期起計的兩個月內，根據註冊外觀設計規則第 51(3) 及 62(4) 條，採用指明外觀設計表格第 D9 號提交反對通知。如在限期內沒有收到任何反對通知，處長將依本公報刊登的更正請求的內容，准許是項更正請求。

If any person wishes to oppose the following requests, he shall file a notice of opposition in specified Designs Form D9 within two months from the date of advertisement in this official journal under sections 51(3) and 62(4) of the Registered Designs Rules. If no notice of opposition is received, the requests for correction will be allowed by the Registrar in the present advertised form.

1800108.9

[17] 05-07-2019