

香港知識產權公報

Hong Kong Intellectual Property Journal

2020年11月27日
27 November 2020

目錄 Contents

根據註冊外觀設計條例第 25 條註冊的外觀設計

Designs Registered under section 25 of the Registered Designs Ordinance

按註冊編號排列

Arranged by Registration Number

根據註冊外觀設計條例(第 522 章)公布的其他公告

Other Notices Published under the Registered Designs Ordinance (Cap. 522)

根據註冊外觀設計條例第 28 條，註冊外觀設計因未繳續期費而停止有效

Registered designs ceased through non-payment of renewal fees under section 28 of the Registered Designs Ordinance

根據註冊外觀設計規則第 31 條刪除的註冊外觀設計

Registered designs removed under section 31 of the Registered Designs Rules

以下事項沒有記錄

No Records for the Following Matters

根據註冊外觀設計條例第 30 條放棄的外觀設計的註冊

Surrender of Registration of Design under section 30 of the Registered Designs Ordinance

根據註冊外觀設計規則第 37 條，向處長作出轉介

Reference to Registrar under section 37 of the Registered Designs Rules

根據註冊外觀設計條例第 45 條，撤銷註冊

Revocation of Registration under section 45 of the Registered Designs Ordinance

根據註冊外觀設計規則第 46 條，向法院作出轉介

Reference to Court under section 46 of the Registered Designs Rules

根據註冊外觀設計規則第 63 條對不符合規定之處作出糾正

Rectification of Irregularities under section 63 of the Registered Designs Rules

根據註冊外觀設計條例第 66 條，糾正註冊紀錄冊

Rectification of Register under section 66 of the Registered Designs Ordinance

根據註冊外觀設計條例第 67 條 更正註冊紀錄冊內的錯誤

Correction of errors in Register under section 67 of the Registered Designs Ordinance

根據註冊外觀設計條例第 67 及 76 條，更正註冊紀錄冊內及已提交文件中的錯誤

Correction of Errors in Register and in Filed Documents under sections 67 and 76 of the Registered Designs Ordinance

根據註冊外觀設計條例第 76 條，更正已提交文件中的錯誤

Correction of errors in filed documents under section 76 of the Registered Designs Ordinance

勘誤

Corrigendum

註冊外觀設計公告註釋

Notes on advertisements of registration of designs

方括號表示下列資料：

Square brackets indicate the following data：

[11] 註冊編號 Registration number / 聯合王國註冊編號 United Kingdom registration number

[15] 註冊日期 Registration date / 當作註冊日期 Deemed registration date / 聯合王國註冊日期 United Kingdom registration date

[17] 註冊有效期屆滿日期 Expiry date of the period of registration

[22] 提交日期 Filing date / 當作提交日期 Deemed filing date / 聯合王國提交日期 United Kingdom filing date

[30] 聲稱享有的優先權（提交日期 / 巴黎公約國或世界貿易組織成員 / 申請編號） Priority claimed (filing date / Paris Convention country or WTO member / application number)

[51] 國際外觀設計分類號（洛迦諾分類號） International Classification of designs (Locarno Classification)

[54] 物品 Article

[55] 外觀設計的表述 Representation of the design

[62] 分開前的申請編號及提交日期 Application number before division and filing date

[66] 過往註冊的聯繫外觀設計註冊編號 / 日期 Registration No. / Date of Previous Registration for Association

[72] 設計人 Designer

[73] 擁有人姓名和地址 Name and address of the owner

[74] 代理人 Agent / 送達地址 Address for service



香港特別行政區政府知識產權署外觀設計註冊處

The Government of the Hong Kong Special Administrative Region

Designs Registry, Intellectual Property Department

根據註冊外觀設計條例第 25 條註冊的外觀設計

Designs registered under section 25 of the Registered Designs Ordinance

按註冊編號排列

Arranged by Registration Number

[11] 2015858.0

[15] 25-03-2020

[51] Cl. 16-06

[54] 頭帶連護眼罩

Head band with protective goggle

[73] 蕭國安

SIU KWOK ON, VINCENT

Rm. 607,

222 Queen's Road Central,

Hong Kong

[74] ACCOLADE IP LIMITED

10/F, Fu Fai Comm. Ctr.,

27 Hillier Street,

Sheung Wan, Hong Kong



[11] 2016051.9M001

[15] 24-04-2020

[51] Cl. 25-99

[54] 踢腳板

Toeboard

[73] 梁德成以準誠建材公司之名營業
LEUNG TAK SHING TRADING AS GOODWILL CONSTRUCTION MATERIAL
COMPANY
香港九龍
大角咀通州街 131 號
宜利大廈地下

[74] 卓遠知識產權有限公司
香港上環
禧利街 27 號
富輝商業中心 10 樓



[11] 2016051.9M002

[15] 24-04-2020

[51] Cl. 25-99

[54] 踢腳板
Toeboard

[73] 梁德成以準誠建材公司之名營業
LEUNG TAK SHING TRADING AS GOODWILL CONSTRUCTION MATERIAL
COMPANY
香港九龍
大角咀通州街 131 號
宜利大廈地下

[74] 卓遠知識產權有限公司
香港上環
禧利街 27 號
富輝商業中心 10 樓



[11] 2016051.9M003

[15] 24-04-2020

[51] Cl. 25-99

[54] 踢腳板

Toeboard

[73] 梁德成以準誠建材公司之名營業

LEUNG TAK SHING TRADING AS GOODWILL CONSTRUCTION MATERIAL
COMPANY

香港九龍

大角咀通州街 131 號

宜利大廈地下

[74] 卓遠知識產權有限公司

香港上環

禧利街 27 號

富輝商業中心 10 樓



[11] 2016217.2

[15] 25-05-2020

[30] 25-11-2019 / US / 29/714,599

[51] Cl. 7-04

[54] 攪拌機

Blender

[73] BlendJet Inc.

5159 Commercial Circle, Suite B,
Concord California 94520,
United States

[74] UNITALEN ATTORNEYS AT LAW LIMITED

Rm 1201, 12/F, Golden Era Plaza,
39-55 Sai Yee St,
Mongkok, Kln, Hong Kong



[11] 2016561.1

[15] 24-07-2020

[30] 29-01-2020 / CA, EG, MC, MA, NO, RU, SG, CH, TN, TR, UA, GB,
US, VN, EU, JP, KR / DM/208 074

[51] Cl. 3-01

[54] 行李箱

Suitcase

[73] HERMES SELLIER

24 Rue du Faubourg Saint Honoré,
75008 Paris,
France

[74] DEACONS

5th Floor, Alexandra House,
Central,
Hong Kong



[11] 2016599.1M001

[15] 04-08-2020

[30] 04-02-2020 / CN / 202030046902.5

[51] Cl. 13-02

[54] 充電器
Charger

[73] 北京小米移動軟件有限公司
BEIJING XIAOMI MOBILE SOFTWARE CO., LTD.
中國內地
北京市海澱區西二旗中路
33 號院 6 號樓 8 層 018 號

[74] 香港派特恩知識產權代理有限公司
香港上環
永樂街 121-125 號
永達商業大廈 10 樓 C 室



[11] 2016599.1M002

[15] 04-08-2020

[30] 04-02-2020 / CN / 202030046902.5

[51] Cl. 13-02

[54] 充電器
Charger

[73] 北京小米移動軟件有限公司
BEIJING XIAOMI MOBILE SOFTWARE CO., LTD.
中國內地
北京市海澱區西二旗中路
33 號院 6 號樓 8 層 018 號

[74] 香港派特恩知識產權代理有限公司
香港上環
永樂街 121-125 號
永達商業大廈 10 樓 C 室



[11] 2016600.5M001

[15] 04-08-2020

[30] 20-05-2020 / CN / 202030233412.6

[51] C1. 11-01

[54] 吊咀

Pendant

[73] 株式會社御木本

KABUSHIKI KAISHA MIKIMOTO (K. MIKIMOTO & Co., Ltd.)

5-5, Ginza 4-Chome,

Chuo-Ku, Tokyo,

Japan

[74] FAIRBAIRN CATLEY LOW & KONG

23/F, Shui On Centre,

6-8 Harbour Road,

Wanchai, Hong Kong

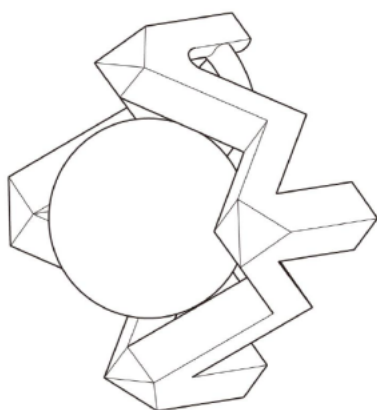

[11] 2016600.5M002

[15] 04-08-2020

[30] 20-05-2020 / CN / 202030233412.6

[51] Cl. 11-01

[54] 耳環
Earring

[73] 株式會社御木本
KABUSHIKI KAISHA MIKIMOTO (K. MIKIMOTO & Co., Ltd.)
5-5, Ginza 4-Chome,
Chuo-Ku, Tokyo,
Japan

[74] FAIRBAIRN CATLEY LOW & KONG
23/F, Shui On Centre,
6-8 Harbour Road,
Wanchai, Hong Kong

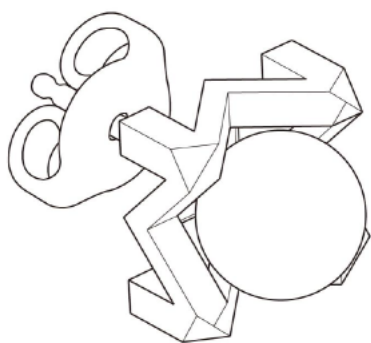

[11] 2016601.7M001

[15] 05-08-2020

[51] Cl. 11-01

[54] 飾物設計
Ornament design

[73] 六福集團有限公司
Luk Fook Holdings Company Limited
Floor 15, 20, 25 & 27, Metropole Square,
No.2 On Yiu Street,
Shatin, New Territories, Hong Kong

[74] Luk Fook Holdings Company Limited (Legal Affairs Department)
Floor 25, Metropole Square,
No.2 On Yiu Street,
Shatin, New Territories, Hong Kong



[11] 2016601.7M002

[15] 05-08-2020

[51] Cl. 11-01

[54] 飾物設計

Ornament design

[73] 六福集團有限公司

Luk Fook Holdings Company Limited

Floor 15, 20, 25 & 27, Metropole Square,

No.2 On Yiu Street,

Shatin, New Territories, Hong Kong

[74] Luk Fook Holdings Company Limited (Legal Affairs Department)

Floor 25, Metropole Square,

No.2 On Yiu Street,

Shatin, New Territories, Hong Kong



[11] 2016601.7M003

[15] 05-08-2020

[51] Cl. 11-01

[54] 飾物設計

Ornament design

[73] 六福集團有限公司

Luk Fook Holdings Company Limited
Floor 15, 20, 25 & 27, Metropole Square,
No.2 On Yiu Street,
Shatin, New Territories, Hong Kong

[74] Luk Fook Holdings Company Limited (Legal Affairs Department)

Floor 25, Metropole Square,
No.2 On Yiu Street,
Shatin, New Territories, Hong Kong



[11] 2016601.7M004

[15] 05-08-2020

[51] Cl. 11-01

[54] 飾物設計

Ornament design

[73] 六福集團有限公司

Luk Fook Holdings Company Limited
Floor 15, 20, 25 & 27, Metropole Square,
No.2 On Yiu Street,
Shatin, New Territories, Hong Kong

[74] Luk Fook Holdings Company Limited (Legal Affairs Department)

Floor 25, Metropole Square,
No.2 On Yiu Street,
Shatin, New Territories, Hong Kong



[11] 2016601.7M005

[15] 05-08-2020

[51] Cl. 11-01

[54] 飾物設計

Ornament design

[73] 六福集團有限公司

Luk Fook Holdings Company Limited

Floor 15, 20, 25 & 27, Metropole Square,

No.2 On Yiu Street,

Shatin, New Territories, Hong Kong

[74] Luk Fook Holdings Company Limited (Legal Affairs Department)

Floor 25, Metropole Square,

No.2 On Yiu Street,

Shatin, New Territories, Hong Kong



[11] 2016601.7M006

[15] 05-08-2020

[51] Cl. 11-01

[54] 飾物設計

Ornament design

[73] 六福集團有限公司

Luk Fook Holdings Company Limited

Floor 15, 20, 25 & 27, Metropole Square,

No.2 On Yiu Street,

Shatin, New Territories, Hong Kong

[74] Luk Fook Holdings Company Limited (Legal Affairs Department)

Floor 25, Metropole Square,

No.2 On Yiu Street,

Shatin, New Territories, Hong Kong



[11] 2016601.7M007

[15] 05-08-2020

[51] Cl. 11-01

[54] 飾物設計

Ornament design

[73] 六福集團有限公司

Luk Fook Holdings Company Limited

Floor 15, 20, 25 & 27, Metropole Square,

No.2 On Yiu Street,

Shatin, New Territories, Hong Kong

[74] Luk Fook Holdings Company Limited (Legal Affairs Department)

Floor 25, Metropole Square,

No.2 On Yiu Street,

Shatin, New Territories, Hong Kong



[11] 2016602.9

[15] 05-08-2020

[30] 05-02-2020 / US / 29/723,299

[51] Cl. 25-01

[54] 圓筒形樁連連接件

Cylindrical pile with connecting element

[73] 板樁有限責任公司

SHEET PILING LLC

P.O. Box 366, Austin, Texas 78767,
United States

- [74] CLT PATENT & TRADEMARK (H.K.) LIMITED
Unit 09, 34/F., Office Tower, Convention Plaza,
No. 1 Harbour Road,
Wanchai, Hong Kong

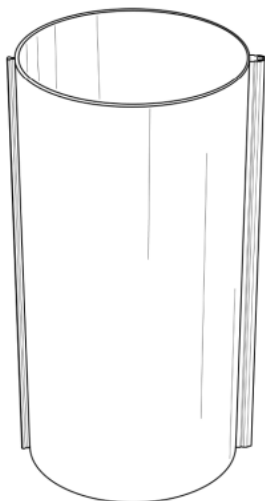

-
- [11] 2016603.1
[15] 05-08-2020
[30] 03-03-2020 / AM, AZ, BZ, BA, GE, LI, MK, MD, MC, MN, ME, MA,
NO, OM, SG, CH, TN, TR, UA, GB, EU, AL, KG / DM/206 525
[51] Cl. 10-07
[54] 錶面
Dial
[73] MONTRES JAQUET DROZ SA (MONTRES JAQUET DROZ AG) (MONTRES
JAQUET DROZ LTD.)
Allée du Tourbillon 2,
CH-2300 La Chaux-de-Fonds,
Switzerland
[74] SPRUSON & FERGUSON (HONG KONG) LIMITED
5001 Hopewell Centre,
183 Queen's Road East,
Wan Chai, Hong Kong



[11] 2016604.3

[15] 05-08-2020

[30] 28-02-2020 / JP / 003800 of 2020

[51] Cl. 16-03

[54] 炭粉容器

Toner container

[73] Toshiba Tec Kabushiki Kaisha

1-11-1, Osaki, Shinagawa-ku,

Tokyo,

Japan

[74] DEACONS

5th Floor, Alexandra House,

Central,

Hong Kong

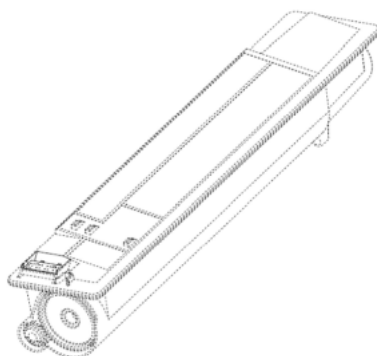

[11] 2016606.8

[15] 05-08-2020

[30] 17-03-2020 / CH / 145201

[51] Cl. 10-07

[54] 錶殼
Watch case

[73] Montres Tudor SA
3, rue François-Dussaud,
1211 Genève 26,
Switzerland

[74] DEACONS
5th Floor, Alexandra House,
Central,
Hong Kong

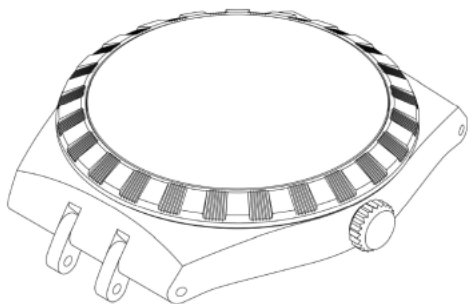

[11] 2016607.0

[15] 05-08-2020

[51] Cl. 14-01

[54] 耳機
Headphone

[73] 申鴻權
中國內地
吉林省和龍市文化街二居十組

[74] 滙誠知識產權有限公司
香港灣仔
軒尼詩道 397 號
東區商業大廈 1206 室



[11] 2016609.4

[15] 05-08-2020

[51] Cl. 9-03

[54] 包裝盒

Packaging box

[73] 卡萊美化妝品有限公司

Colourmix Cosmetics Company Limited

10th Floor, Wylar Centre Phase II,

192-200 Tai Lin Pai Road,

Kwai Chung, New Territories, Hong Kong

[74] MARKPAL IP LIMITED

Unit A, 11/F Amtel Building,

144-148 Des Voeux Road Central,

Hong Kong



- [11] 2016610.6
[15] 05-08-2020
[30] 06-02-2020 / US / 29/723,429
[51] Cl. 14-01
[54] 頭戴式耳機
Headphone
[73] Skullcandy, Inc.
6301 N. Landmark Dr. Park City, UT 84098,
United States
[74] CLT PATENT & TRADEMARK (H.K.) LIMITED
Unit 09, 34/F., Office Tower, Convention Plaza,
No. 1 Harbour Road,
Wanchai, Hong Kong



-
- [11] 2016611.8
[15] 05-08-2020
[51] Cl. 13-02
[54] 無線充電手機消毒盒
Disinfection box wireless charging of mobile phone
[73] 杰美泰實業（深圳）有限公司
中國內地
廣東省深圳市寶安區沙井街道
茅洲山工業園工業大廈全至科技創新園科創大廈 14 層 G
[74] 海思國際知識產權有限公司
香港
灣仔皇后大道東 183 號
合和中心 54 樓

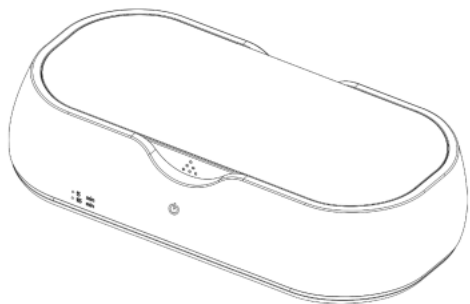

[11] 2016612.0

[15] 06-08-2020

[51] Cl. 23-04

[54] 空氣淨化器
Air purifier

[73] 樂活科技(國際)有限公司
Lohas Technology (International) Ltd
香港九龍
觀塘開源道 47 號
凱源工業大廈 7 樓 J 室

[74] 卓遠知識產權有限公司
香港上環
禧利街 27 號
富輝商業中心 10 樓



[11] 2016613.2

[15] 06-08-2020

[51] Cl. 9-01

[54] 容器

Container

[73] AXXZIA 股份有限公司

AXXZIA INC.

6-3-1 Nishi-Shinjuku,

Shinjuku-ku, Tokyo,

Japan

[74] CLT PATENT & TRADEMARK (H.K.) LIMITED

Unit 09, 34/F., Office Tower, Convention Plaza,

No. 1 Harbour Road,

Wanchai, Hong Kong



[11] 2016614.4

[15] 06-08-2020

[51] Cl. 9-03

[54] 包裝盒

Packaging box

[73] AXXZIA 股份有限公司

AXXZIA INC.

6-3-1 Nishi-Shinjuku,

Shinjuku-ku, Tokyo,

Japan

[74] CLT PATENT & TRADEMARK (H.K.) LIMITED

Unit 09, 34/F., Office Tower, Convention Plaza,

No. 1 Harbour Road,

Wanchai, Hong Kong



[11] 2016615.7M001

[15] 06-08-2020

[51] Cl. 23-04

[54] 香薰機

Aroma diffuser

[73] 璞真生活有限公司

PUZHEN LIFE CO., LTD

Unit 1112-1116, 11/F, Delta House,
3 On Yiu Street, Shatin,

Hong Kong

[74] FEDERATION OF HONG KONG INDUSTRIES

31/F, Billion Plaza,

8 Cheung Yue Street,

Cheung Sha Wan, Kowloon, Hong Kong

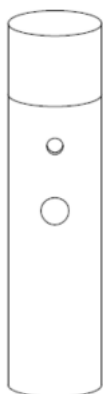

[11] 2016615.7M002

[15] 06-08-2020

[51] Cl. 23-04

[54] 香薰機

Aroma diffuser

[73] 璞真生活有限公司

PUZHEN LIFE CO., LTD

Unit 1112-1116, 11/F, Delta House,

3 On Yiu Street, Shatin,

Hong Kong

[74] FEDERATION OF HONG KONG INDUSTRIES

31/F, Billion Plaza,

8 Cheung Yue Street,

Cheung Sha Wan, Kowloon, Hong Kong

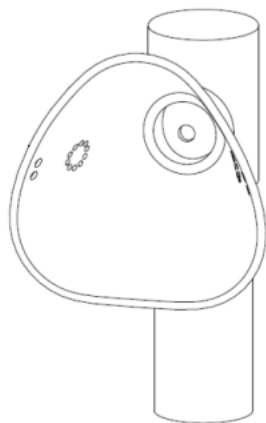

[11] 2016615.7M003

[15] 06-08-2020

[51] Cl. 23-04

[54] 香薰機

Aroma diffuser

[73] 璞真生活有限公司

PUZHEN LIFE CO., LTD

Unit 1112-1116, 11/F, Delta House,

3 On Yiu Street, Shatin,

Hong Kong

[74] FEDERATION OF HONG KONG INDUSTRIES

31/F, Billion Plaza,

8 Cheung Yue Street,

Cheung Sha Wan, Kowloon, Hong Kong

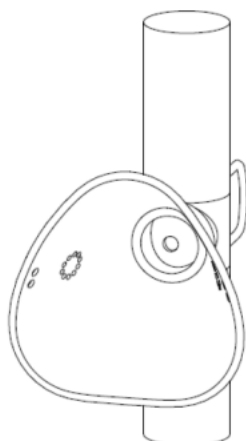

[11] 2016615.7M004

[15] 06-08-2020

[51] Cl. 23-04

[54] 香薰機

Aroma diffuser

[73] 璞真生活有限公司

PUZHEN LIFE CO., LTD

Unit 1112-1116, 11/F, Delta House,
3 On Yiu Street, Shatin,

Hong Kong

[74] FEDERATION OF HONG KONG INDUSTRIES

31/F, Billion Plaza,

8 Cheung Yue Street,

Cheung Sha Wan, Kowloon, Hong Kong



[11] 2016615.7M005

[15] 06-08-2020

[51] Cl. 23-04

[54] 香薰機

Aroma diffuser

[73] 璞真生活有限公司

PUZHEN LIFE CO., LTD

Unit 1112-1116, 11/F, Delta House,

3 On Yiu Street, Shatin,

Hong Kong

[74] FEDERATION OF HONG KONG INDUSTRIES

31/F, Billion Plaza,

8 Cheung Yue Street,

Cheung Sha Wan, Kowloon, Hong Kong



[11] 2016615.7M006

[15] 06-08-2020

[51] Cl. 23-04

[54] 香薰機

Aroma diffuser

[73] 璞真生活有限公司

PUZHEN LIFE CO., LTD

Unit 1112-1116, 11/F, Delta House,

3 On Yiu Street, Shatin,

Hong Kong

[74] FEDERATION OF HONG KONG INDUSTRIES

31/F, Billion Plaza,

8 Cheung Yue Street,

Cheung Sha Wan, Kowloon, Hong Kong



[11] 2016615.7M007

[15] 06-08-2020

[51] Cl. 23-04

[54] 香薰機

Aroma diffuser

[73] 璞真生活有限公司

PUZHEN LIFE CO., LTD

Unit 1112-1116, 11/F, Delta House,
3 On Yiu Street, Shatin,

Hong Kong

[74] FEDERATION OF HONG KONG INDUSTRIES

31/F, Billion Plaza,

8 Cheung Yue Street,

Cheung Sha Wan, Kowloon, Hong Kong



[11] 2016616.9

[15] 06-08-2020

[30] 07-02-2020 / EU / 007669791

[51] Cl. 21-01

[54] 玩具汽車
Toy car

[73] FERRARI S.p.A.
Via Emilia EST 1163,
I-41100 Modena,
Italy

[74] CHINA PATENT AGENT (HONG KONG) LIMITED
22/F, Great Eagle Centre,
23 Harbour Road,
Wanchai, Hong Kong

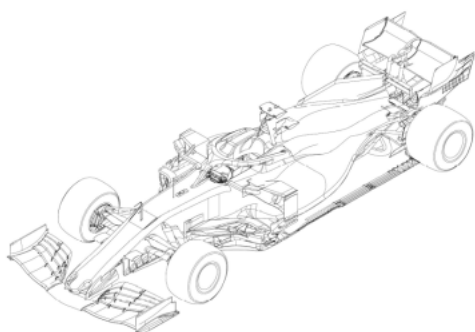

[11] 2016617.1

[15] 06-08-2020

[30] 07-02-2020 / EU / 007669767

[51] Cl. 12-08

[54] 汽車
Car

[73] FERRARI S.p.A.
Via Emilia EST 1163,
I-41100 Modena,
Italy

[74] CHINA PATENT AGENT (HONG KONG) LIMITED
22/F, Great Eagle Centre,
23 Harbour Road,
Wanchai, Hong Kong

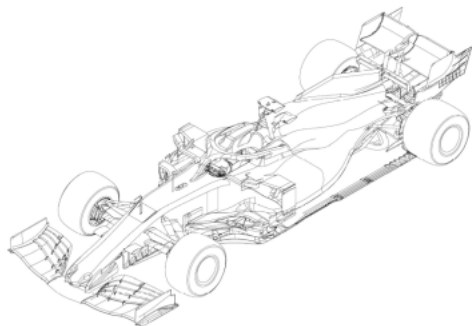

[11] 2016618.3

[15] 06-08-2020

[51] Cl. 23-03

[54] 便攜式浴室暖風機

Portable bathroom heater

[73] 新發電器製品（國際）有限公司

香港新界屯門

杯渡路 76 號

屯門工業中心 E 座一字樓二號室

[74] 新發電器製品（國際）有限公司

香港新界屯門

杯渡路 76 號

屯門工業中心 E 座一字樓二號室

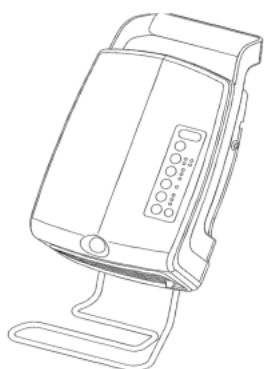

[11] 2016620.7

[15] 06-08-2020

[51] Cl. 23-06

[54] 衛生手帶

Sanitary wristband

[73] 紀力玩具製造有限公司
GEALEX TOYS MANUFACTURING CO. LTD.
Block C & D, 6/F., Kwai Bo Industrial Building,
40 Wong Chuk Hang Road,
Aberdeen, Hong Kong

[74] BENNY KONG & TSAI
Unit 19B, Overseas Trust Bank Building,
No. 160 Gloucester Road,
Wanchai, Hong Kong



[11] 2016622.1

[15] 07-08-2020

[30] 27-02-2020 / EU / 007719364-0001

[51] Cl. 31-00

[54] 啤酒分配器手柄
Handle of beer dispenser

[73] Asahi Group Holdings, Ltd.
23-1, Azumabashi 1-chome,
Sumida-ku, Tokyo 130-8602,
Japan

[74] DEACONS
5th Floor, Alexandra House,
Central,
Hong Kong



[11] 2016626.0

[15] 07-08-2020

[51] Cl. 13-02

[54] 充電底座
Charger base

[73] 渲美美健(深圳)科技股份有限公司
TOUCHBEAUTY BEAUTY & HEALTH (SHENZHEN) CO., LTD
中國內地
深圳市南山區西麗街道曙光社區中山園路
1001 號 TCL 科學園區 F5 棟 601、602

[74] 卓遠知識產權有限公司
香港上環
禧利街 27 號
富輝商業中心 10 樓

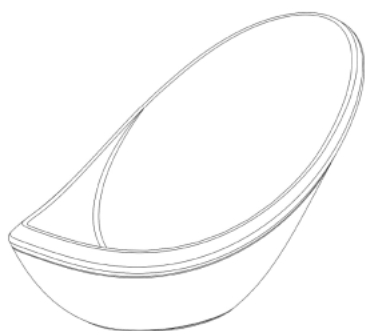

[11] 2016627.2

[15] 07-08-2020

[51] Cl. 28-03

[54] 光子射頻按摩儀

Photon radio frequency massager

[73] 渲美美健（深圳）科技股份有限公司

TOUCHBEAUTY BEAUTY & HEALTH (SHENZHEN) CO., LTD

中國內地

深圳市南山區西麗街道曙光社區中山園路

1001 號 TCL 科學園區 F5 棟 601、602

[74] 卓遠知識產權有限公司

香港上環

禧利街 27 號

富輝商業中心 10 樓

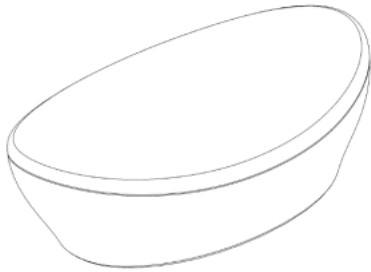

[11] 2016629.6

[15] 07-08-2020

[51] Cl. 7-01

[54] 圓形杯

Round shaped mug

[73] 鄭誠甲

CHENG Shing Kap

香港灣仔

皇后大道東 122-128 號

金港大廈 5 樓 A 室

[74] 鄭誠甲

香港灣仔

皇后大道東 122-128 號

金港大廈 5 樓 A 室



[11] 2016630.8M001

[15] 10-08-2020

[30] 03-03-2020 / CA, AM, AZ, BZ, BA, GE, LI, MK, MD, MC, MN, ME, MA, NO, OM, SG, CH, TN, TR, UA, GB, EU, AL, KG / DM/207 017

[51] Cl. 11-01

[54] 指環
Ring

[73] Harry Winston SA
Chemin du Tourbillon 8,
CH-1228 Plan-les-Ouates,
Switzerland

[74] SPRUSON & FERGUSON (HONG KONG) LIMITED
5001 Hopewell Centre,
183 Queen's Road East,
Wan Chai, Hong Kong



[11] 2016630.8M002

[15] 10-08-2020

[30] 03-03-2020 / CA, AM, AZ, BZ, BA, GE, LI, MK, MD, MC, MN, ME, MA, NO, OM, SG, CH, TN, TR, UA, GB, EU, AL, KG / DM/207 017

[51] Cl. 11-01

[54] 項鍊

Necklace

[73] Harry Winston SA

Chemin du Tourbillon 8,
CH-1228 Plan-les-Ouates,
Switzerland

[74] SPRUSON & FERGUSON (HONG KONG) LIMITED

5001 Hopewell Centre,
183 Queen's Road East,
Wan Chai, Hong Kong



[11] 2016630.8M003

[15] 10-08-2020

[30] 03-03-2020 / CA, AM, AZ, BZ, BA, GE, LI, MK, MD, MC, MN, ME,
MA, NO, OM, SG, CH, TN, TR, UA, GB, EU, AL, KG / DM/207 017

[51] Cl. 11-01

[54] 項鍊

Necklace

[73] Harry Winston SA

Chemin du Tourbillon 8,
CH-1228 Plan-les-Ouates,
Switzerland

[74] SPRUSON & FERGUSON (HONG KONG) LIMITED

5001 Hopewell Centre,
183 Queen's Road East,
Wan Chai, Hong Kong



[11] 2016630.8M004

[15] 10-08-2020

[30] 03-03-2020 / CA, AM, AZ, BZ, BA, GE, LI, MK, MD, MC, MN, ME, MA, NO, OM, SG, CH, TN, TR, UA, GB, EU, AL, KG / DM/207 017

[51] Cl. 11-01

[54] 項鍊

Necklace

[73] Harry Winston SA

Chemin du Tourbillon 8,
CH-1228 Plan-les-Ouates,
Switzerland

[74] SPRUSON & FERGUSON (HONG KONG) LIMITED

5001 Hopewell Centre,
183 Queen's Road East,
Wan Chai, Hong Kong



[11] 2016632.2M001

[15] 10-08-2020

[51] Cl. 21-01

[54] 玩具坦克車
Toy tank

[73] 集美塑膠玩具製品廠有限公司
CHAP MEI PLASTIC TOYS MANUFACTORY LIMITED
Unit 541, 5/F., Sino Industrial Plaza,
9 Kai Cheung Road,
Kowloon Bay, Kowloon, Hong Kong

[74] BENNY KONG & TSAI
Unit 19B, Overseas Trust Bank Building,
No. 160 Gloucester Road,
Wanchai, Hong Kong



[11] 2016632.2M002

[15] 10-08-2020

[51] Cl. 21-01

[54] 玩具鯊魚膠桶
Toy shark bucket

[73] 集美塑膠玩具製品廠有限公司
CHAP MEI PLASTIC TOYS MANUFACTORY LIMITED
Unit 541, 5/F., Sino Industrial Plaza,
9 Kai Cheung Road,
Kowloon Bay, Kowloon, Hong Kong

[74] BENNY KONG & TSAI
Unit 19B, Overseas Trust Bank Building,
No. 160 Gloucester Road,
Wanchai, Hong Kong



[11] 2016634.6

[15] 11-08-2020

[51] Cl. 2-04

[54] 拖鞋
Slipper

[73] 張嘉琪
CHEUNG KA KI
香港葵涌
梨木樹邨
桃樹樓 35 樓 19 室

[74] 卓遠知識產權有限公司
香港上環
禧利街 27 號
富輝商業中心 10 樓





香港特別行政區政府知識產權署外觀設計註冊處

The Government of the Hong Kong Special Administrative Region

Designs Registry, Intellectual Property Department

根據註冊外觀設計條例第 28 條，下列註冊外觀設計因未繳續期費而停止有效。

各組記項按註冊外觀設計停止有效日期及註冊編號先後次序排列。

Registered designs ceased through non-payment of renewal fees under section 28 of the Registered Designs Ordinance. Entries are listed below under their expiry dates.

17-09-2020 - 23-09-2020

| | |
|-------------------|-------------------|
| 17-09-2020 | 0502243.1 |
| 1502056.7M001 | 1502086.0 |
| 1502056.7M002 | |
| 1502056.7M003 | 23-09-2020 |
| 1502062.9 | 1001593.9 |
| 1502066.8M001 | 1001733.7 |
| 1502066.8M002 | 1001734.9 |
| 1502066.8M003 | 1001737.6 |
| 1502066.8M004 | 1001738.8 |
| 1502067.0 | 1502089.6 |
| | 1502107.6 |
| 19-09-2020 | 1502108.8 |
| 1100349.2M003 | |
| 1100349.2M004 | |

20-09-2020

1001709.7
1001713.5
1502070.6
1502071.8M001
1502071.8M002
1502072.0

21-09-2020

0502225.4
0502226.6
0502227.8M001
0502227.8M002
0502228.0
1001722.4
1502074.4
1502078.3

22-09-2020



香港特別行政區政府知識產權署外觀設計註冊處

The Government of the Hong Kong Special Administrative Region

Designs Registry, Intellectual Property Department

根據註冊外觀設計規則第 31 條刪除的註冊外觀設計。各組記項按註冊外觀設計刪除日期及註冊編號先後次序排列。

Registered designs removed under section 31 of the Registered Designs Rules. Entries are listed below under their removal dates.

06-11-2020 - 12-11-2020

| | | |
|-------------------|-------------------|-------------------|
| 06-11-2020 | 1500705.3M006 | 0010356.6 |
| 0500565.3M001 | 1500707.7 | 0500596.8 |
| 0500565.3M002 | 1500708.9M001 | 1000507.8 |
| 0500565.3M003 | 1500708.9M002 | 1500725.5 |
| 0500565.3M004 | 1500709.1 | 1500728.1 |
| 1000486.1 | 1500710.3 | 1500730.5 |
| 1000487.3 | | 1500731.7 |
| 1500697.4 | 08-11-2020 | 1500734.3 |
| 1500698.6 | 1500713.9 | 1500736.8 |
| 1500700.2M001 | 1500719.2M001 | |
| 1500700.2M002 | 1500719.2M002 | 12-11-2020 |
| 1500700.2M003 | 1500719.2M003 | 0500601.0M002 |
| 1500700.2M004 | 1500719.2M004 | 0500605.9M001 |
| 1500701.4M001 | 1500719.2M005 | 1000513.0 |
| 1500701.4M002 | 1500719.2M006 | 1000514.2 |
| 1500701.4M003 | 1500719.2M007 | 1000515.5 |
| 1500701.4M004 | 1500719.2M008 | 1000516.7 |
| 1500702.6M001 | 1500720.4 | 1000517.9 |
| 1500702.6M002 | 1500722.8M001 | 1000518.1 |
| 1500702.6M003 | 1500722.8M002 | 1500740.6 |
| 1500702.6M004 | 1500723.0 | 1500741.8M001 |
| | 1501921.1 | 1500741.8M002 |
| | | 1500742.0M002 |
| 07-11-2020 | 09-11-2020 | |
| 1000488.5 | 0500571.5M001 | |
| 1000493.5 | 0500571.5M002 | |
| 1000494.7 | | |
| 1000495.0 | 10-11-2020 | |
| 1500704.0M001 | 0500584.2M001 | |
| 1500704.0M002 | 0500584.2M002 | |
| 1500705.3M001 | 1000502.7 | |
| 1500705.3M002 | 1000503.9 | |
| 1500705.3M003 | | |
| 1500705.3M004 | 11-11-2020 | |
| 1500705.3M005 | | |