

香港知識產權公報

Hong Kong Intellectual Property Journal

2021年5月28日

28 May 2021

目錄 Contents

根據註冊外觀設計條例第 25 條註冊的外觀設計

Designs Registered under section 25 of the Registered Designs Ordinance

按註冊編號排列

Arranged by Registration Number

根據註冊外觀設計條例(第 522 章)公布的其他公告

Other Notices Published under the Registered Designs Ordinance (Cap. 522)

根據註冊外觀設計條例第 28 條，註冊外觀設計因未繳續期費而停止有效

Registered designs ceased through non-payment of renewal fees under section 28 of the Registered Designs Ordinance

根據註冊外觀設計規則第 31 條刪除的註冊外觀設計

Registered designs removed under section 31 of the Registered Designs Rules

以下事項沒有記錄

No Records for the Following Matters

根據註冊外觀設計條例第 30 條放棄的外觀設計的註冊

Surrender of Registration of Design under section 30 of the Registered Designs Ordinance

根據註冊外觀設計規則第 37 條，向處長作出轉介

Reference to Registrar under section 37 of the Registered Designs Rules

根據註冊外觀設計條例第 45 條，撤銷註冊

Revocation of Registration under section 45 of the Registered Designs Ordinance

根據註冊外觀設計規則第 46 條，向法院作出轉介

Reference to Court under section 46 of the Registered Designs Rules

根據註冊外觀設計規則第 63 條對不符合規定之處作出糾正

Rectification of Irregularities under section 63 of the Registered Designs Rules

根據註冊外觀設計條例第 66 條，糾正註冊紀錄冊

Rectification of Register under section 66 of the Registered Designs Ordinance

根據註冊外觀設計條例第 67 條 更正註冊紀錄冊內的錯誤

Correction of errors in Register under section 67 of the Registered Designs Ordinance

根據註冊外觀設計條例第 67 及 76 條，更正註冊紀錄冊內及已提交文件中的錯誤

Correction of Errors in Register and in Filed Documents under sections 67 and 76 of the Registered Designs Ordinance

根據註冊外觀設計條例第 76 條，更正已提交文件中的錯誤

Correction of errors in filed documents under section 76 of the Registered Designs Ordinance

勘誤

Corrigendum

註冊外觀設計公告註釋

Notes on advertisements of registration of designs

方括號表示下列資料：

Square brackets indicate the following data：

[11] 註冊編號 Registration number / 聯合王國註冊編號 United Kingdom registration number

[15] 註冊日期 Registration date / 當作註冊日期 Deemed registration date / 聯合王國註冊日期 United Kingdom registration date

[17] 註冊有效期屆滿日期 Expiry date of the period of registration

[22] 提交日期 Filing date / 當作提交日期 Deemed filing date / 聯合王國提交日期 United Kingdom filing date

[30] 聲稱享有的優先權（提交日期 / 巴黎公約國或世界貿易組織成員 / 申請編號） Priority claimed (filing date / Paris Convention country or WTO member / application number)

[51] 國際外觀設計分類號（洛迦諾分類號） International Classification of designs (Locarno Classification)

[54] 物品 Article

[55] 外觀設計的表述 Representation of the design

[62] 分開前的申請編號及提交日期 Application number before division and filing date

[66] 過往註冊的聯繫外觀設計註冊編號 / 日期 Registration No. / Date of Previous Registration for Association

[72] 設計人 Designer

[73] 擁有人姓名和地址 Name and address of the owner

[74] 代理人 Agent /送達地址 Address for service



香港特別行政區政府知識產權署外觀設計註冊處

The Government of the Hong Kong Special Administrative Region

Designs Registry, Intellectual Property Department

根據註冊外觀設計條例第 25 條註冊的外觀設計

Designs registered under section 25 of the Registered Designs Ordinance

按註冊編號排列

Arranged by Registration Number

[11] 1602015.2M001

[15] 24-10-2016

[51] Cl. 3-01

[54] 行李箱

The Luggage

[73] 唐文達

香港尖沙咀

漆咸道南 61-65 號

首都廣場 3 樓 T233

[74] 達明貿易公司

香港九龍

何文田恬文樓 416 室



[11] 1602015.2M002

[15] 24-10-2016

[51] Cl. 3-01

- [54] 行李箱
The Luggage
- [73] 唐文達
香港尖沙咀
漆咸道南 61-65 號
首都廣場 3 樓 T233
- [74] 達明貿易公司
香港九龍
何文田恬文樓 416 室



-
- [11] 1602015.2M003
- [15] 24-10-2016
- [51] Cl. 3-01
- [54] 行李箱
The Luggage
- [73] 唐文達
香港尖沙咀
漆咸道南 61-65 號
首都廣場 3 樓 T233
- [74] 達明貿易公司
香港九龍
何文田恬文樓 416 室



[11] 2117379.6

[15] 06-01-2021

[30] 07-07-2020 / US / 29/740,778

[51] Cl. 1-01

[54] 馬鈴薯切制食品

Food cut from a potato

[73] 蘭博韋斯頓有限責任公司

Lamb Weston, Inc.

599S. Rivershore Lane,

Eagle, ID83616,

United States

[74] MARKS & CLERK

Level 9, Cyberport 1,

100 Cyberport Road,

Pok Fu Lam, Hong Kong

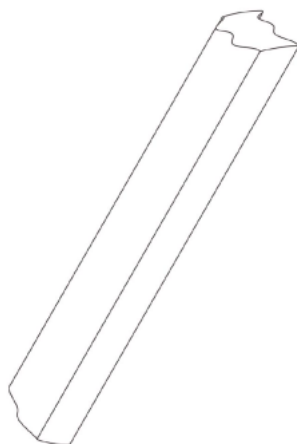

- [11] 2117540.9
[15] 05-02-2021
[30] 05-08-2020 / KR / 30-2020-0036511
[51] Cl. 24-01
[54] 舒緩身體痛楚的裝置
Device for pain scrambler body
[73] LG Jeon za Joo-sik-hoi-sa (LG Electronics Inc.)
128, Yeoui-daero,
Yeongdeungpo-gu, Seoul, 150-721,
Korea, Republic of
[74] SPRUSON & FERGUSON (HONG KONG) LIMITED
5001 Hopewell Centre,
183 Queen's Road East,
Wan Chai, Hong Kong

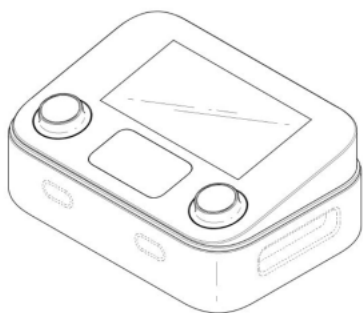

-
- [11] 2117653.8
[15] 03-03-2021
[30] 03-09-2020 / EU / 008157556
[51] Cl. 13-03
[54] 旋轉燈開關
Rotary light switch
[73] Plejd AB
Göteborgsvägen 52,
431 37 Mölndal,
Sweden
[74] VIVIEN CHAN & CO
32/F, Harbour Centre,
25 Harbour Road,
Wanchai, Hong Kong

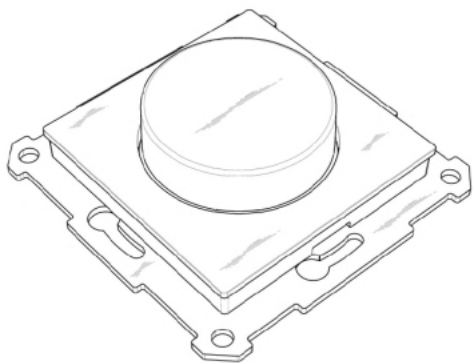

[11] 2117669.2M001

[15] 08-03-2021

[30] 03-03-2021 / US / 29/772,747
07-09-2020 / US / 29/749,525

[51] Cl. 21-02

[54] 健身腳踏車
Exercise bicycle

[73] PELOTON INTERACTIVE, INC.
125 West 25th Street,
11th Floor, New York, New York 10001,
United States

[74] HNC INNOVATION LIMITED
Units 1205-1208, Cyberport 2,
No. 100 Cyberport Road,
Hong Kong



[11] 2117669.2M002

[15] 08-03-2021

[30] 03-03-2021 / US / 29/772,747
07-09-2020 / US / 29/749,525

[51] Cl. 21-02

[54] 健身腳踏車

Exercise bicycle

[73] PELOTON INTERACTIVE, INC.

125 West 25th Street,
11th Floor, New York, New York 10001,
United States

[74] HNC INNOVATION LIMITED

Units 1205-1208, Cyberport 2,
No. 100 Cyberport Road,
Hong Kong

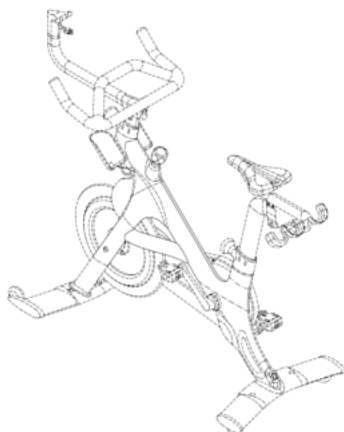

[11] 2117669.2M003

[15] 08-03-2021

[30] 03-03-2021 / US / 29/772,747
07-09-2020 / US / 29/749,525

[51] Cl. 21-02

[54] 健身腳踏車

Exercise bicycle

[73] PELOTON INTERACTIVE, INC.

125 West 25th Street,
11th Floor, New York, New York 10001,
United States

[74] HNC INNOVATION LIMITED

Units 1205-1208, Cyberport 2,
No. 100 Cyberport Road,
Hong Kong



[11] 2117731.4M001

[15] 22-03-2021

[51] C1. 6-08

[54] 空間衣架
Space hanger

[73] 張裕
香港九龍
油塘油麗邨
康麗樓 612 室

[74] 張裕
香港九龍
油塘油麗邨
康麗樓 612 室

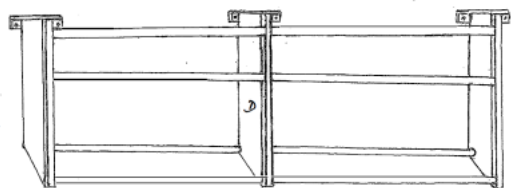

[11] 2117731.4M002

[15] 22-03-2021

[51] C1. 6-08

[54] 空間衣架
Space hanger

[73] 張裕
香港九龍
油塘油麗邨
康麗樓 612 室

[74] 張裕
香港九龍
油塘油麗邨
康麗樓 612 室

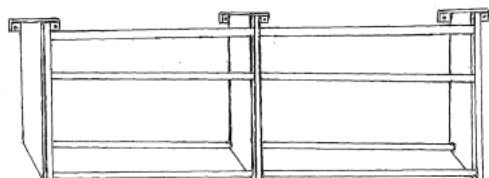

[11] 2117731.4M003

[15] 22-03-2021

[51] Cl. 6-08

[54] 空間衣架
Space hanger

[73] 張裕
香港九龍
油塘油麗邨
康麗樓 612 室

[74] 張裕
香港九龍
油塘油麗邨
康麗樓 612 室

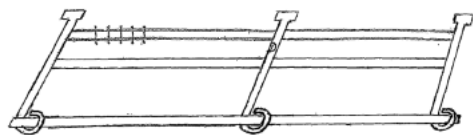

[11] 2117762.9M001

[15] 26-03-2021

[30] 02-10-2020 / EU / 008193809-0001

[51] Cl. 12-08

[54] 汽車
Automobile

[73] Bugatti International S.A.
412F route d'Esch,

1030 Luxembourg,
Luxembourg

[74] WENPING PATENT & TRADE MARK AGENT LIMITED
1701 Tung Wai Commercial Building,
111 Gloucester Road,
Hong Kong



[11] 2117762.9M002

[15] 26-03-2021

[30] 02-10-2020 / EU / 008193809-0006

[51] Cl. 12-16

[54] 汽車車身零件

Body part for vehicles

[73] Bugatti International S.A.

412F route d'Esch,

1030 Luxembourg,

Luxembourg

[74] WENPING PATENT & TRADE MARK AGENT LIMITED

1701 Tung Wai Commercial Building,

111 Gloucester Road,

Hong Kong

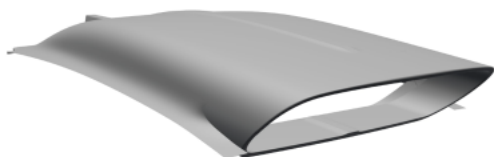

[11] 2117762.9M003

[15] 26-03-2021

[30] 02-10-2020 / EU / 008193809-0007

[51] Cl. 12-16

[54] 汽車車身零件

Body part for vehicles

[73] Bugatti International S.A.

412F route d'Esch,

1030 Luxembourg,

Luxembourg

[74] WENPING PATENT & TRADE MARK AGENT LIMITED

1701 Tung Wai Commercial Building,

111 Gloucester Road,

Hong Kong



[11] 2117762.9M004

[15] 26-03-2021

[30] 02-10-2020 / EU / 008193809-0008

[51] Cl. 12-16

[54] 汽車車身零件

Body part for vehicles

[73] Bugatti International S.A.

412F route d'Esch,

1030 Luxembourg,

Luxembourg

[74] WENPING PATENT & TRADE MARK AGENT LIMITED

1701 Tung Wai Commercial Building,

111 Gloucester Road,

Hong Kong



[11] 2117762.9M005

[15] 26-03-2021

[30] 02-10-2020 / EU / 008193809-0009

[51] Cl. 12-16

[54] 汽車車身零件

Body part for vehicles

[73] Bugatti International S.A.

412F route d'Esch,

1030 Luxembourg,

Luxembourg

[74] WENPING PATENT & TRADE MARK AGENT LIMITED

1701 Tung Wai Commercial Building,

111 Gloucester Road,

Hong Kong

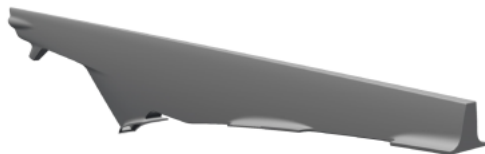

[11] 2117762.9M006

[15] 26-03-2021

[30] 02-10-2020 / EU / 008193809-0010

[51] Cl. 12-16

[54] 汽車車身零件

Body part for vehicles

[73] Bugatti International S.A.

412F route d'Esch,

1030 Luxembourg,

Luxembourg

[74] WENPING PATENT & TRADE MARK AGENT LIMITED

1701 Tung Wai Commercial Building,

111 Gloucester Road,

Hong Kong

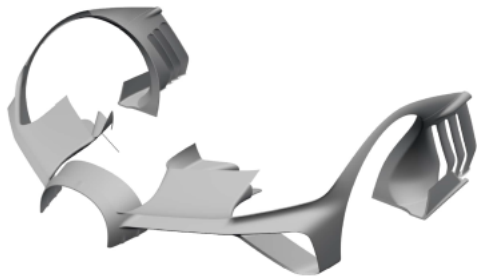

[11] 2117762.9M007

[15] 26-03-2021

[30] 02-10-2020 / EU / 008193809-0011

[51] Cl. 12-16

[54] 汽車輪輞

Wheel rim for vehicles

[73] Bugatti International S.A.

412F route d'Esch,

1030 Luxembourg,

Luxembourg

[74] WENPING PATENT & TRADE MARK AGENT LIMITED

1701 Tung Wai Commercial Building,

111 Gloucester Road,

Hong Kong

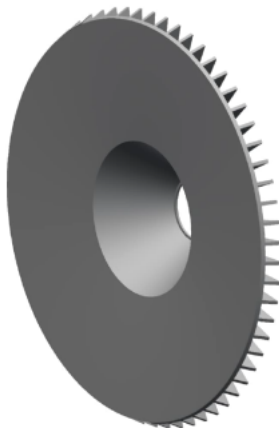

[11] 2117762.9M008

[15] 26-03-2021

[30] 02-10-2020 / EU / 008193809-0012

[51] Cl. 12-16

[54] 汽車車身零件

Body part for vehicles

[73] Bugatti International S.A.

412F route d'Esch,

1030 Luxembourg,

Luxembourg

[74] WENPING PATENT & TRADE MARK AGENT LIMITED

1701 Tung Wai Commercial Building,

111 Gloucester Road,

Hong Kong

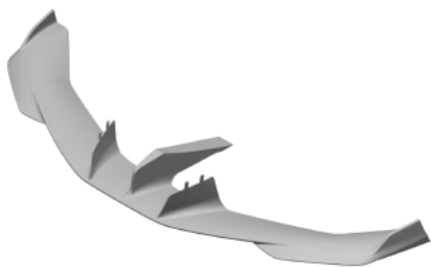

[11] 2117762.9M009

[15] 26-03-2021

[30] 02-10-2020 / EU / 008193809-0013

[51] Cl. 12-16

[54] 汽車車身零件

Body part for vehicles

[73] Bugatti International S.A.

412F route d'Esch,

1030 Luxembourg,

Luxembourg

[74] WENPING PATENT & TRADE MARK AGENT LIMITED

1701 Tung Wai Commercial Building,

111 Gloucester Road,

Hong Kong



[11] 2117762.9M010

[15] 26-03-2021

[30] 02-10-2020 / EU / 008193809-0014

[51] Cl. 12-16

[54] 汽車車身零件

Body part for vehicles

[73] Bugatti International S.A.

412F route d'Esch,

1030 Luxembourg,

Luxembourg

[74] WENPING PATENT & TRADE MARK AGENT LIMITED

1701 Tung Wai Commercial Building,

111 Gloucester Road,

Hong Kong



[11] 2117762.9M011

[15] 26-03-2021

[30] 02-10-2020 / EU / 008193809-0015

[51] Cl. 12-16

[54] 汽車車身零件

Body part for vehicles

[73] Bugatti International S.A.

412F route d'Esch,

1030 Luxembourg,

Luxembourg

[74] WENPING PATENT & TRADE MARK AGENT LIMITED

1701 Tung Wai Commercial Building,

111 Gloucester Road,

Hong Kong



[11] 2117762.9M012

[15] 26-03-2021

[30] 02-10-2020 / EU / 008193809-0016

[51] Cl. 12-16

[54] 汽車車身零件

Body part of vehicles

[73] Bugatti International S.A.

412F route d'Esch,

1030 Luxembourg,

Luxembourg

[74] WENPING PATENT & TRADE MARK AGENT LIMITED

1701 Tung Wai Commercial Building,

111 Gloucester Road,

Hong Kong

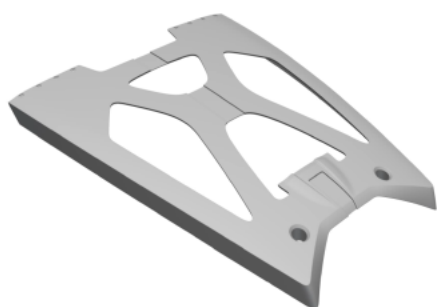

- [11] 2117828.0
[15] 09-04-2021
[30] 30-12-2020 / EU / 008374417-0001
[51] Cl. 3-01
[54] 袋
Bag
[73] Fendi S.r.l.
Palazzo della Civiltà Italiana,
Quadrato della Concordia 3,
00144 Roma,
Italy
[74] BAKER & MCKENZIE
14th Floor, One Taikoo Place,
979 King's Road,
Quarry Bay, Hong Kong



-
- [11] 2117829.2
[15] 09-04-2021
[30] 30-12-2020 / EU / 008374409-0001
[51] Cl. 3-01
[54] 袋
Bag
[73] Fendi S.r.l.
Palazzo della Civiltà Italiana,
Quadrato della Concordia 3,
00144 Roma,
Italy
[74] BAKER & MCKENZIE
14th Floor, One Taikoo Place,

979 King's Road,
Quarry Bay, Hong Kong



[11] 2117831.6

[15] 09-04-2021

[30] 26-10-2020 / CN / 202030640019.9

[51] Cl. 14-01

[54] 耳機

Earphone

[73] 北京小米移動軟件有限公司

BEIJING XIAOMI MOBILE SOFTWARE CO., LTD.

中國內地

北京市海澱區西二旗中路

33 號院 6 號樓 8 層 018 號

[74] 香港派特恩知識產權代理有限公司

香港上環

永樂街 121-125 號

永達商業大廈 10 樓 C 室

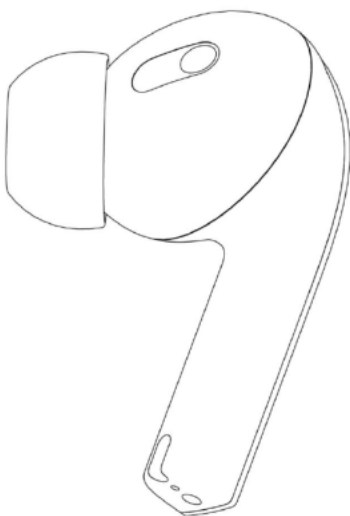

- [11] 2117832.8
[15] 09-04-2021
[30] 26-10-2020 / CN / 202030639425.3
[51] C1. 14-01
[54] 耳機
Earphone
[73] 北京小米移動軟件有限公司
BEIJING XIAOMI MOBILE SOFTWARE CO., LTD.
中國內地
北京市海澱區西二旗中路
33 號院 6 號樓 8 層 018 號
[74] 香港派特恩知識產權代理有限公司
香港上環
永樂街 121-125 號
永達商業大廈 10 樓 C 室

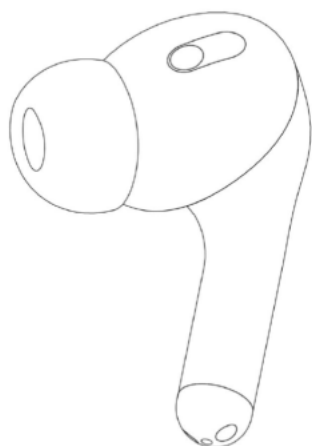

-
- [11] 2117833.0
[15] 09-04-2021
[51] C1. 24-04
[54] 痔瘡治療墊
Hemorrhoids treatment pad
[73] 陳永強
CHAN, Wing Keung
香港
柴灣柴灣邨
灣映樓 1102 室
[74] 智群科技設計（香港）有限公司
香港九龍

九龍灣宏光道 8 號
創豪坊 7 樓 706 室

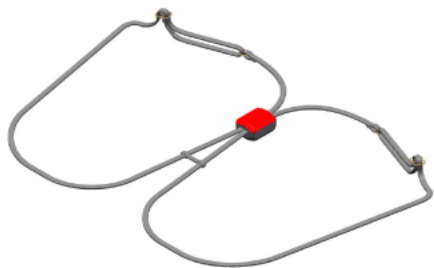

[11] 2117834.2M001

[15] 09-04-2021

[51] Cl. 28-03

[54] 磁性梳

Magnetic comb

[73] Sumchi Limited

10C, Gaylord Commercial Building,

114-118 Lockhart Road,

Wanchai, Hong Kong

[74] ACCOLADE IP LIMITED

10/F, Fu Fai Comm. Ctr.,

27 Hillier Street,

Sheung Wan, Hong Kong

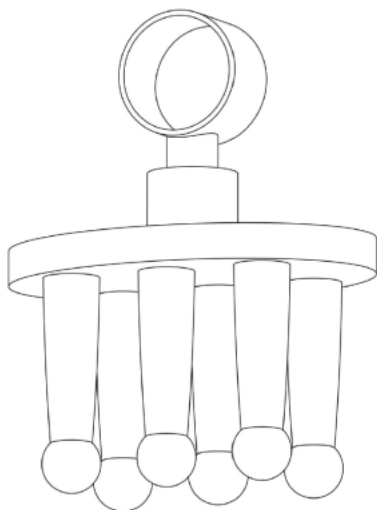

[11] 2117834.2M002

[15] 09-04-2021

[51] Cl. 28-03

[54] 磁性梳

Magnetic comb

[73] Sumchi Limited

10C, Gaylord Commercial Building,
114-118 Lockhart Road,
Wanchai, Hong Kong

[74] ACCOLADE IP LIMITED

10/F, Fu Fai Comm. Ctr.,
27 Hillier Street,
Sheung Wan, Hong Kong

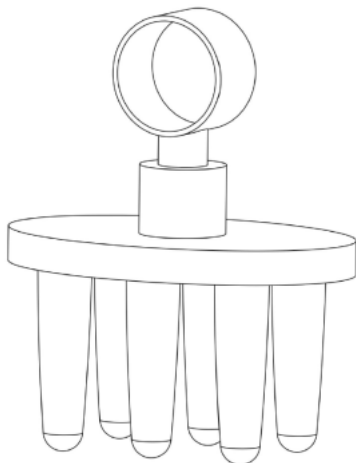

[11] 2117836.7

[15] 09-04-2021

[30] 13-10-2020 / CN / 202030608532.X

[51] Cl. 13-02

[54] 手遊裝置的無線充電器

Wireless charger for mobile game device

[73] 廣東高普達集團股份有限公司

GUANGDONG GOPOD GROUP HOLDING CO., LTD.

中國內地

廣東省深圳市龍華新區大浪街道同勝社區華榮路

聯建科技工業園廠房 8 棟 4, 5, 6 樓

[74] 中港專利有限公司

香港

港灣道 1 號會展廣場

辦公大樓 30 樓 3012 室

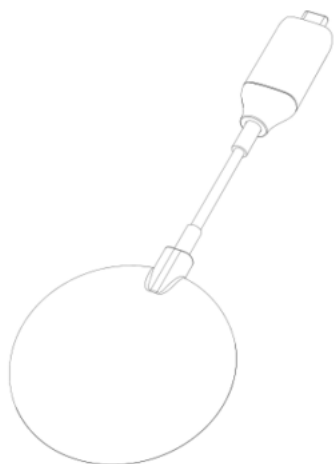

[11] 2117837.9

[15] 09-04-2021

[30] 13-10-2020 / CN / 202030607954.5

[51] C1. 13-02

[54] 無線充電行動電源

Portable wireless charging power bank

[73] 廣東高普達集團股份有限公司

GUANGDONG GOPOD GROUP HOLDING CO., LTD.

中國內地

廣東省深圳市龍華新區大浪街道同勝社區華榮路

聯建科技工業園廠房 8 棟 4, 5, 6 樓

[74] 中港專利有限公司

香港

港灣道 1 號會展廣場

辦公大樓 30 樓 3012 室



[11] 2117839.3

[15] 12-04-2021

[30] 04-11-2020 / JP / 023813 of 2020

[51] Cl. 9-05

[54] 包裝用袋

Packaging bag

[73] FUTAMURA KAGAKU KABUSHIKI KAISHA
29-16, Meieki 2-Chome, Nakamura-Ku,
Nagoya-Shi, Aichi,
Japan

[74] CHINA PATENT AGENT (HONG KONG) LIMITED
22/F, Great Eagle Centre,
23 Harbour Road,
Wanchai, Hong Kong

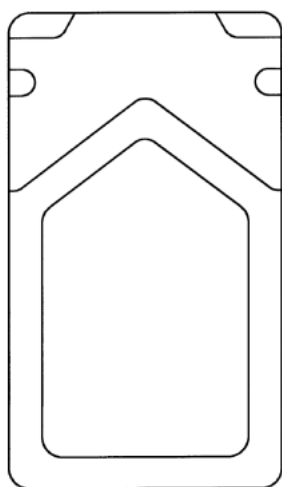

[11] 2117840.5M001

[15] 12-04-2021

[30] 22-10-2020 / EU / 008211742

[51] Cl. 23-06

[54] 手提花灑

Hand shower

[73] Hansgrohe SE
Auestr. 5-9,
77761 Schiltach,
Germany

[74] Rouse & Co. International (Overseas) Limited
18/F., Golden Centre,
188 Des Voeux Road Central,
Hong Kong



[11] 2117840.5M002

[15] 12-04-2021

[30] 22-10-2020 / EU / 008211742

[51] Cl. 23-06

[54] 手提花灑

Hand shower

[73] Hansgrohe SE

Auestr. 5-9,

77761 Schiltach,

Germany

[74] Rouse & Co. International (Overseas) Limited

18/F., Golden Centre,

188 Des Voeux Road Central,

Hong Kong



[11] 2117840.5M003

[15] 12-04-2021

[30] 22-10-2020 / EU / 008211742

[51] Cl. 23-06

[54] 花灑頭的一部分

Part of shower head

[73] Hansgrohe SE

Auestr. 5-9,

77761 Schiltach,

Germany

[74] Rouse & Co. International (Overseas) Limited

18/F., Golden Centre,

188 Des Voeux Road Central,

Hong Kong

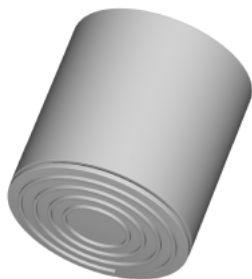

[11] 2117840.5M004

[15] 12-04-2021

[30] 22-10-2020 / EU / 008211742

[51] Cl. 23-06

[54] 花灑頭的一部分

Part of shower head

[73] Hansgrohe SE

Auestr. 5-9,

77761 Schiltach,

Germany

[74] Rouse & Co. International (Overseas) Limited

18/F., Golden Centre,

188 Des Voeux Road Central,

Hong Kong

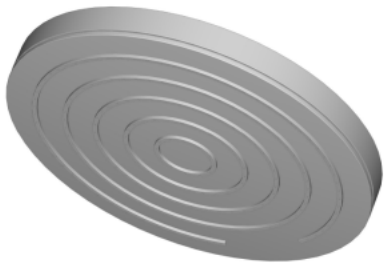

[11] 2117840.5M005

[15] 12-04-2021

[30] 22-10-2020 / EU / 008211742

[51] Cl. 23-06

[54] 花灑頭的一部分

Part of shower head

[73] Hansgrohe SE

Austr. 5-9,
77761 Schiltach,
Germany

[74] Rouse & Co. International (Overseas) Limited

18/F., Golden Centre,
188 Des Voeux Road Central,
Hong Kong

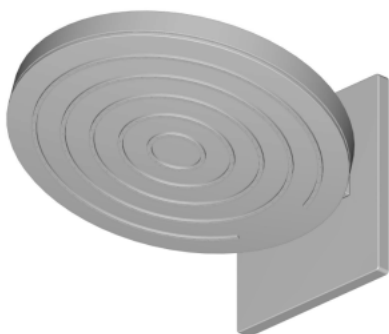

[11] 2117840.5M006

[15] 12-04-2021

[30] 22-10-2020 / EU / 008211742

[51] Cl. 23-01

[54] 調節溫度混合器

Thermostatic mixer

[73] Hansgrohe SE

Auestr. 5-9,

77761 Schiltach,

Germany

[74] Rouse & Co. International (Overseas) Limited

18/F., Golden Centre,

188 Des Voeux Road Central,

Hong Kong

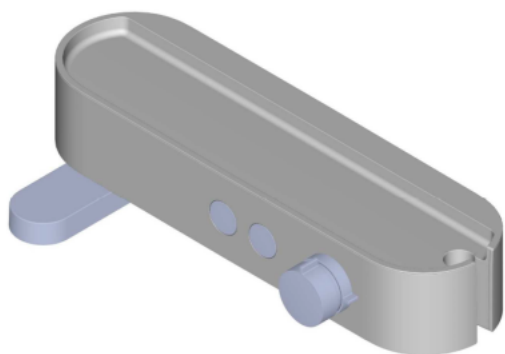

[11] 2117840.5M007

[15] 12-04-2021

[30] 22-10-2020 / EU / 008211742

[51] Cl. 23-06

[54] 花灑裝置

Shower installation

[73] Hansgrohe SE

Auestr. 5-9,

77761 Schiltach,

Germany

[74] Rouse & Co. International (Overseas) Limited

18/F., Golden Centre,

188 Des Voeux Road Central,

Hong Kong



[11] 2117841.7

[15] 12-04-2021

[30] 27-10-2020 / AU / 202015851

[51] Cl. 13-02

[54] 電動車輛充電設備

A charging station for electric vehicles

[73] Tritium Holdings Pty Ltd

Unit 1, 31 Archimedes Place,

Murarrie, QLD 4172,

Australia

[74] DEACONS

5th Floor, Alexandra House,

Central,

Hong Kong

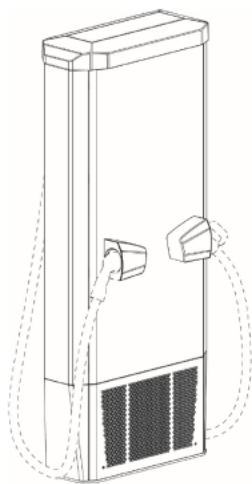

[11] 2117842.9

- [15] 12-04-2021
- [30] 22-11-2020 / CN / 202030708947.4
- [51] Cl. 12-13
- [54] 飛機牽引車
Aircraft tractor
- [73] 威海廣泰空港設備股份有限公司
Weihai Guangtai Airport Equipment Co., Ltd.
中國內地
山東省威海市
環翠區黃河街16號
- [74] 旻貝國際知識產權代理有限公司
香港新界
白石角香港科學園
第三期科技大道西12號2樓230室



-
- [11] 2117844.3M001
- [15] 13-04-2021
- [30] 04-11-2020 / CA, AM, AZ, BZ, BA, GE, LI, MK, MD, MC, MN, ME, MA, NO, OM, SG, CH, TN, TR, UA, GB, EU, AL, KG / DM/211 165
- [51] Cl. 11-01
- [54] 手鏈
Bracelet
- [73] Harry Winston SA
Chemin du Tourbillon 8,
CH-1228 Plan-les-Ouates,
Switzerland
- [74] SPRUSON & FERGUSON (HONG KONG) LIMITED
5001 Hopewell Centre,
183 Queen's Road East,
Wan Chai, Hong Kong



[11] 2117844.3M002

[15] 13-04-2021

[30] 04-11-2020 / CA, AM, AZ, BZ, BA, GE, LI, MK, MD, MC, MN, ME, MA, NO, OM, SG, CH, TN, TR, UA, GB, EU, AL, KG / DM/211 165

[51] Cl. 11-01

[54] 指環
Ring

[73] Harry Winston SA
Chemin du Tourbillon 8,
CH-1228 Plan-les-Ouates,
Switzerland

[74] SPRUSON & FERGUSON (HONG KONG) LIMITED
5001 Hopewell Centre,
183 Queen's Road East,
Wan Chai, Hong Kong



[11] 2117844.3M003

[15] 13-04-2021

[30] 04-11-2020 / CA, AM, AZ, BZ, BA, GE, LI, MK, MD, MC, MN, ME, MA, NO, OM, SG, CH, TN, TR, UA, GB, EU, AL, KG / DM/211 165

[51] Cl. 11-01

[54] 指環
Ring

[73] Harry Winston SA
Chemin du Tourbillon 8,
CH-1228 Plan-les-Ouates,
Switzerland

[74] SPRUSON & FERGUSON (HONG KONG) LIMITED
5001 Hopewell Centre,
183 Queen's Road East,
Wan Chai, Hong Kong



[11] 2117844.3M004

[15] 13-04-2021

[30] 04-11-2020 / CA, AM, AZ, BZ, BA, GE, LI, MK, MD, MC, MN, ME, MA, NO, OM, SG, CH, TN, TR, UA, GB, EU, AL, KG / DM/211 165

[51] Cl. 11-01

[54] 指環
Ring

[73] Harry Winston SA
Chemin du Tourbillon 8,
CH-1228 Plan-les-Ouates,
Switzerland

[74] SPRUSON & FERGUSON (HONG KONG) LIMITED
5001 Hopewell Centre,
183 Queen's Road East,
Wan Chai, Hong Kong



[11] 2117844.3M005

[15] 13-04-2021

[30] 04-11-2020 / CA, AM, AZ, BZ, BA, GE, LI, MK, MD, MC, MN, ME, MA, NO, OM, SG, CH, TN, TR, UA, GB, EU, AL, KG / DM/211 165

[51] Cl. 11-01

[54] 指環
Ring

[73] Harry Winston SA
Chemin du Tourbillon 8,
CH-1228 Plan-les-Ouates,
Switzerland

[74] SPRUSON & FERGUSON (HONG KONG) LIMITED
5001 Hopewell Centre,
183 Queen's Road East,
Wan Chai, Hong Kong



[11] 2117844.3M006

[15] 13-04-2021

[30] 04-11-2020 / CA, AM, AZ, BZ, BA, GE, LI, MK, MD, MC, MN, ME,
MA, NO, OM, SG, CH, TN, TR, UA, GB, EU, AL, KG / DM/211 165

[51] Cl. 11-01

[54] 指環
Ring

[73] Harry Winston SA
Chemin du Tourbillon 8,
CH-1228 Plan-les-Ouates,
Switzerland

[74] SPRUSON & FERGUSON (HONG KONG) LIMITED
5001 Hopewell Centre,
183 Queen's Road East,
Wan Chai, Hong Kong



- [11] 2117845.6
[15] 13-04-2021
[51] Cl. 28-03
[54] 美容儀器底座
Beauty apparatus base
[73] 璞真生活有限公司
Puzhen Life Co., Limited
Unit 1112-1116, 11/F, Delta House,
3 On Yiu Street,
Shatin, Hong Kong
[74] FEDERATION OF HONG KONG INDUSTRIES
31/F, Billion Plaza,
8 Cheung Yue Street,
Cheung Sha Wan, Kowloon, Hong Kong

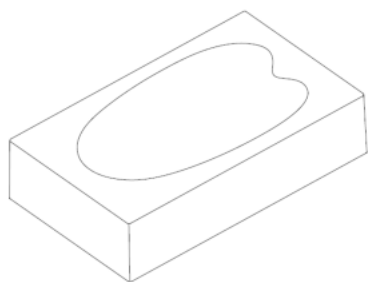

-
- [11] 2117848.2
[15] 13-04-2021
[30] 13-11-2020 / KR / 30-2020-0055167
[51] Cl. 29-02
[54] 面具式空氣淨化器的面部接觸墊
Facial contact pad for mask type air purifiers
[73] LG Jeon za Joo-sik-hoi-sa (LG ELECTRONICS INC.)
128, Yeoui-daero,
Yeongdeungpo-gu, Seoul, 150-721,
Korea, Republic of
[74] SPRUSON & FERGUSON (HONG KONG) LIMITED
5001 Hopewell Centre,
183 Queen's Road East,
Wan Chai, Hong Kong

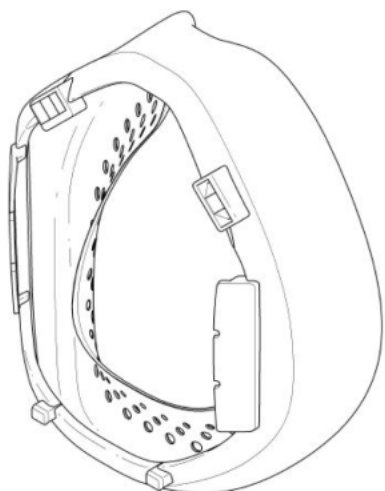

[11] 2117851.8

[15] 14-04-2021

[51] Cl. 9-03

[54] 包裝盒

Packaging box

[73] 內蒙古蒙牛乳業（集團）股份有限公司

INNER MONGOLIA MENGNIU DAIRY (GROUP) CO., LTD.

中國內地

內蒙古自治區呼和浩特市和林格爾盛樂經濟園區 011500

[74] 海思國際知識產權有限公司

香港灣仔

皇后大道東 183 號

合和中心 54 樓



- [11] 2117853.2
[15] 15-04-2021
[51] Cl. 9-05
[54] 包裝袋
Packing bag
[73] 聯耀食品有限公司
LUEN YIU FOOD TRADING LIMITED
Room 10, 9th Floor, Block A2,
Yau Tong Industrial City,
17 Ko Fai Road,
Yau Tong, Kowloon, Hong Kong
[74] VINCENT LUK & ASSOCIATES
Unit A, 13th Floor, Nathan Commercial Building,
430 Nathan Road, Kowloon,
Hong Kong



-
- [11] 2117854.4
[15] 15-04-2021
[51] Cl. 9-05
[54] 包裝袋
Packing bag
[73] 聯耀食品有限公司
LUEN YIU FOOD TRADING LIMITED
Room 10, 9th Floor, Block A2,
Yau Tong Industrial City,
17 Ko Fai Road,
Yau Tong, Kowloon, Hong Kong
[74] VINCENT LUK & ASSOCIATES
Unit A, 13th Floor, Nathan Commercial Building,
430 Nathan Road,
Kowloon, Hong Kong



[11] 2117855.7

[15] 15-04-2021

[30] 11-11-2020 / EU / 008264576-0001

[51] Cl. 3-01

[54] 行李箱
Suitcase

[73] RIMOWA GmbH
Richard-Byrd-Str. 13,
50829 Cologne,
Germany

[74] ROBIN BRIDGE & JOHN LIU
6th Floor, Emperor Commercial Centre,
39 Des Voeux Road Central,
Hong Kong



[11] 2117856.9M001

[15] 15-04-2021

[30] 10-02-2021 / CH, GB, US, VN, EU, KR / WIPO101500

[51] Cl. 31-00

[54] 咖啡研磨機

Coffee grinder

[73] Hemro AG

Länggenstrasse 34,

8184 Bachenbülach,

Switzerland

[74] DEACONS

5th Floor, Alexandra House,

Central,

Hong Kong



[11] 2117856.9M002

[15] 15-04-2021

[30] 10-02-2021 / CH, GB, US, VN, EU, KR / WIPO101500

[51] Cl. 31-00

[54] 咖啡研磨機

Coffee grinder

[73] Hemro AG

Länggenstrasse 34,

8184 Bachenbülach,

Switzerland

[74] DEACONS

5th Floor, Alexandra House,

Central,

Hong Kong



[11] 2117857.1M001

[15] 15-04-2021

[30] 20-10-2020 / US / 29/755,448

[51] Cl. 24-02

[54] 安瓿粉碎工具

Ampule crush tool

[73] VERRICA PHARMACEUTICALS INC.

44 West Gay Street, Suite 400

West Chester, PA 19380

UNITED STATES OF AMERICA

[74] DEACONS

5th Floor, Alexandra House,

Central,

Hong Kong

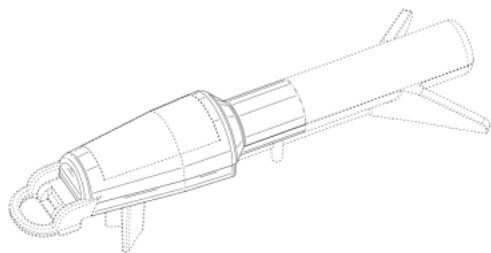

[11] 2117857.1M002

[15] 15-04-2021

[30] 20-10-2020 / US / 29/755,448

[51] Cl. 24-02

[54] 安瓿粉碎工具

Ampule crush tool

[73] VERRICA PHARMACEUTICALS INC.
44 West Gay Street, Suite 400
West Chester, PA 19380
UNITED STATES OF AMERICA

[74] DEACONS
5th Floor, Alexandra House,
Central,
Hong Kong

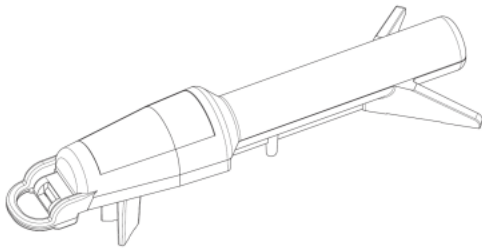

[11] 2117858.3

[15] 16-04-2021

[51] Cl. 9-03

[54] 藥品包裝盒
Medicine packaging box

[73] 德勝藥妝有限公司
TAK SHING COSMECEUTICAL LIMITED
Room 37, Unit 8-12, 12/F, Lladro Centre,
72 Hoi Yuen Road,
Kwun Tong, Kowloon, Hong Kong

[74] 企正服務有限公司
香港九龍
旺角亞皆老街 109 號
皆旺商業大廈 2202 室





香港特別行政區政府知識產權署外觀設計註冊處

The Government of the Hong Kong Special Administrative Region

Designs Registry, Intellectual Property Department

根據註冊外觀設計條例第 28 條，下列註冊外觀設計因未繳續期費而停止有效。

各組記項按註冊外觀設計停止有效日期及註冊編號先後次序排列。

Registered designs ceased through non-payment of renewal fees under section 28 of the Registered Designs Ordinance. Entries are listed below under their expiry dates.

05-03-2021 - 10-03-2021**05-03-2021**

0600513.4
0600514.6
0600518.5M002
0600518.5M003
0600518.5M004
0600518.5M005
0600518.5M006
0600519.7
0600524.7

06-03-2021

1600382.6
1600383.8M001
1600383.8M002
1600383.8M003
1600384.0
1600385.3
1600386.5

07-03-2021

0600536.3
1100393.4M001
1100393.4M002
1100393.4M003
1600392.7M001
1600392.7M002
1600395.4

08-03-2021

0600543.7
1600397.8
1600398.0

09-03-2021

1100406.4M003
1100406.4M004
1100406.4M005
1100406.4M006
1100406.4M008
1100406.4M009
1100406.4M010
1100406.4M011
1100406.4M012

1600396.6

1600402.0

1600406.9

1600407.1

1600415.8

10-03-2021

1100419.1
1600411.9M001
1600411.9M002
1600411.9M003
1600411.9M004
1600413.3
1600414.5
1600417.2
1600422.2M001
1600422.2M002
1600422.2M003
1600422.2M004

1600424.6

1600427.3

1600430.9



香港特別行政區政府知識產權署外觀設計註冊處

The Government of the Hong Kong Special Administrative Region

Designs Registry, Intellectual Property Department

根據註冊外觀設計規則第 31 條刪除的註冊外觀設計。各組記項按註冊外觀設計刪除日期及註冊編號先後次序排列。

Registered designs removed under section 31 of the Registered Designs Rules. Entries are listed below under their removal dates.

08-05-2021 - 13-05-2021

08-05-2021 0502095.7M001
1001607.1M003 0502095.7M002

1001626.1M001

09-05-2021 1001626.1M002

0011223.5 1001626.1M003

0502067.8 1001626.1M004

1001609.5 1001626.1M005

1001615.8M001 1001628.5M001

1001615.8M002 1001628.5M002

1001616.0 1001628.5M003

1501963.9 1001628.5M004

1501965.4 1501994.4

1501966.6 1501995.7M001

1501968.0 1501995.7M002

1501969.2 1502006.2

1501970.4 1502010.0

1501971.6

1501972.8

1501973.0

12-05-2021

1001632.3

1001640.0M001

1001640.0M002

10-05-2021

0502079.3 1001640.0M003

0502081.7 1001640.0M004

1501667.2 1502014.8

1501668.4 1502015.1M001

1501669.6 1502015.1M002

1501670.8

1501984.3

13-05-2021

1501985.6 0011237.5

1501986.8 1502016.3M001

1501989.4 1502016.3M002

1502025.2

11-05-2021

0502094.4 1502028.8

1502029.0