



香港特別行政區政府  
知識產權署  
Intellectual Property Department  
The Government of the Hong Kong  
Special Administrative Region

# 香港知識產權公報

Hong Kong Intellectual Property Journal

2019 年 6 月 28 日

28 June 2019

## 目錄 Contents

### 根據註冊外觀設計條例第 25 條註冊的外觀設計

#### **Designs Registered under section 25 of the Registered Designs Ordinance**

按註冊編號排列

Arranged by Registration Number

### 根據註冊外觀設計條例(第 522 章)公布的其他公告

#### **Other Notices Published under the Registered Designs Ordinance (Cap. 522)**

根據註冊外觀設計條例第 28 條, 註冊外觀設計因未繳續期費而停止有效

Registered designs ceased through non-payment of renewal fees under section 28 of the Registered Designs Ordinance

根據註冊外觀設計規則第 31 條刪除的註冊外觀設計

Registered designs removed under section 31 of the Registered Designs Rules

根據註冊外觀設計條例第 67 及 76 條, 更正註冊紀錄冊內及已提交文件中的錯誤

Correction of Errors in Register and in Filed Documents under sections 67 and 76 of the Registered Designs Ordinance

### 以下事項沒有記錄

#### **No Records for the Following Matters**

根據註冊外觀設計條例第 30 條放棄的外觀設計的註冊

Surrender of Registration of Design under section 30 of the Registered Designs Ordinance

根據註冊外觀設計規則第 37 條, 向處長作出轉介

Reference to Registrar under section 37 of the Registered Designs Rules

根據註冊外觀設計條例第 45 條，撤銷註冊

Revocation of Registration under section 45 of the Registered Designs Ordinance

根據註冊外觀設計規則第 46 條，向法院作出轉介

Reference to Court under section 46 of the Registered Designs Rules

根據註冊外觀設計規則第 63 條對不符合規定之處作出糾正

Rectification of Irregularities under section 63 of the Registered Designs Rules

根據註冊外觀設計條例第 66 條，糾正註冊紀錄冊

Rectification of Register under section 66 of the Registered Designs Ordinance

根據註冊外觀設計條例第 67 條，更正註冊紀錄冊內的錯誤

Correction of Errors in Register under section 67 of the Registered Designs Ordinance

根據註冊外觀設計條例第 76 條，更正已提交文件中的錯誤

Correction of Errors in Filed Documents under section 76 of the Registered Designs Ordinance

勘誤

Corrigendum

## 註冊外觀設計公告註釋

### Notes on advertisements of registration of designs

方括號表示下列資料：

Square brackets indicate the following data：

[11] 註冊編號 Registration number / 聯合王國註冊編號 United Kingdom registration number

[15] 註冊日期 Registration date / 當作註冊日期 Deemed registration date / 聯合王國註冊日期 United Kingdom registration date

[17] 註冊有效期屆滿日期 Expiry date of the period of registration

[22] 提交日期 Filing date / 當作提交日期 Deemed filing date / 聯合王國提交日期 United Kingdom filing date

[30] 聲稱享有的優先權 ( 提交日期 / 巴黎公約國或世界貿易組織成員 / 申請編號 ) Priority claimed (filing date / Paris Convention country or WTO member / application number)

[51] 國際外觀設計分類號 ( 洛迦諾分類號 ) International Classification of designs (Locarno Classification)

[54] 物品 Article

[55] 外觀設計的表述 Representation of the design

[62] 分開前的申請編號及提交日期 Application number before division and filing date

[66] 過往註冊的聯繫外觀設計註冊編號 / 日期 Registration No. / Date of Previous Registration for Association

[72] 設計人 Designer

[73] 擁有人姓名和地址 Name and address of the owner

[74] 代理人 Agent / 送達地址 Address for service



香港特別行政區政府知識產權署外觀設計註冊處

The Government of the Hong Kong Special Administrative Region

Designs Registry, Intellectual Property Department

## 根據註冊外觀設計條例第 25 條註冊的外觀設計

### Designs registered under section 25 of the Registered Designs Ordinance

按註冊編號排列

Arranged by Registration Number

[11] 1802195.4

[15] 07-11-2018

[51] Cl. 5-05

[54] 用於床笠、枕袋及被袋的針活性印花純棉

Thread count reactive print for fitted sheet, pillow case and quilt cover

[73] Casablanca International Limited

香港新界 沙田火炭黃竹洋

街 9-13 號 仁興中心五樓

[74] Casablanca International Limited

香港新界 沙田火炭黃竹洋

街 9-13 號 仁興中心五樓



---

[11] 1802210.7

[15] 09-11-2018

[30] 11-05-2018 / CN / 201830215308 .7

[51] Cl. 9-02

[54] 真空存儲罐

Vacuum storage tank

[73] 丫互科技(深圳)有限公司

中國內地廣東省深圳市羅湖區

黃貝街道沿河北路 1002 號

瑞思國際大廈 A 座五層

[74] 港智國際知識產權代理有限公司

香港屯門

震寰路 3 號

德榮工業大廈 20 字樓 B6 室

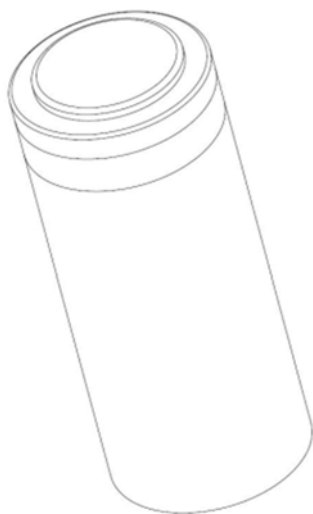

---

[11] 1802211.9

[15] 09-11-2018

[30] 11-05-2018 / CN / 201830215309.1

[51] Cl. 9-02

[54] 真空存儲罐

Vacuum storage tank

[73] 丫互科技(深圳)有限公司

中國內地廣東省深圳市羅湖區

黃貝街道沿河北路 1002 號

瑞思國際大廈 A 座五層

[74] 港智國際知識產權代理有限公司

香港屯門

震寰路 3 號

德榮工業大廈 20 字樓 B6 室

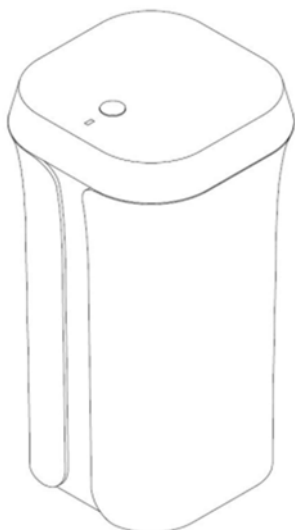

---

[11] 1802348.9

[15] 28-11-2018

[51] Cl. 26-05

[54] 玩字

Scrabble lamp

[73] 陳焯婷

香港新界

沙田安麗街 11 號

企業中心 10 樓 1003&1005 室

龔翊豪

香港新界

沙田安麗街 11 號

企業中心 10 樓 1003&1005 室

賈智 香

港新界

沙田安麗街 11 號

企業中心 10 樓 1003&1005 室

張兆嫻

香港新界

沙田安麗街 11 號

企業中心 10 樓 1003&1005 室

[74] 陳焯婷

香港新界 沙田安

麗街 11 號

企業中心 10 樓 1003&1005 室



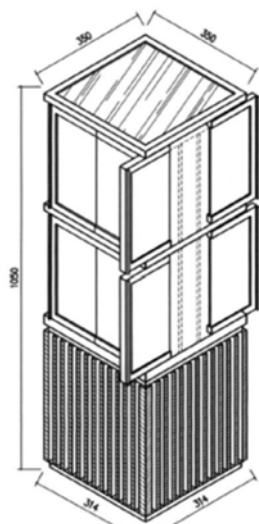

---

[11] 1802378.2M001

[15] 03-12-2018

[30] 03-06-2018 / US / 29/649,907

[51] Cl. 14-04

[54] 用於電子裝置的圖標

Icon for electronic device

[73] 蘋果公司

APPLE INC.

ONE APPLE PARK WAY,

CUPERTINO, CALIFORNIA 95014,

UNITED STATES

[74] CLT Patent & Trademark (H.K.) Ltd.

Unit 09, 34/F., Office Tower, Convention Plaza,

No. 1 Harbour Road, Wanchai,

Hong Kong.



---

[11] 1802378.2M002

[15] 03-12-2018

[30] 03-06-2018 / US / 29/649,907

[51] Cl. 14-04

[54] 用於電子裝置的圖標

Icon for electronic device

[73] 蘋果公司

APPLE INC.

ONE APPLE PARK WAY,

CUPERTINO, CALIFORNIA 95014,

UNITED STATES

[74] CLT Patent & Trademark (H.K.) Ltd.

Unit 09, 34/F., Office Tower, Convention Plaza,

No. 1 Harbour Road, Wanchai,

Hong Kong.



---

[11] 1802378.2M003

[15] 03-12-2018

[30] 03-06-2018 / US / 29/649,907

[51] Cl. 14-04

[54] 用於電子裝置的圖標

Icon for electronic device

[73] 蘋果公司

APPLE INC.

ONE APPLE PARK WAY,

CUPERTINO, CALIFORNIA 95014,

UNITED STATES

[74] CLT Patent & Trademark (H.K.) Ltd.

Unit 09, 34/F., Office Tower, Convention Plaza,

No. 1 Harbour Road, Wanchai,

Hong Kong.



---

[11] 1802378.2M004

[15] 03-12-2018

[30] 03-06-2018 / US / 29/649,907

[51] Cl. 14-04

[54] 用於電子裝置的圖形用戶界面

Graphical user interface for electronic device

[73] 蘋果公司

APPLE INC.

ONE APPLE PARK WAY,

CUPERTINO, CALIFORNIA 95014,

UNITED STATES

[74] CLT Patent & Trademark (H.K.) Ltd.

Unit 09, 34/F., Office Tower, Convention Plaza,

No. 1 Harbour Road, Wanchai,

Hong Kong.



---

[11] 1802378.2M005

[15] 03-12-2018

[30] 03-06-2018 / US / 29/649,907

[51] Cl. 14-04

[54] 用於電子裝置的圖形用戶界面

Graphical user interface for electronic device

[73] 蘋果公司

APPLE INC.

ONE APPLE PARK WAY,

CUPERTINO, CALIFORNIA 95014,

UNITED STATES

[74] CLT Patent & Trademark (H.K.) Ltd.

Unit 09, 34/F., Office Tower, Convention Plaza,

No. 1 Harbour Road, Wanchai,

Hong Kong.



---

[11] 1802378.2M006

[15] 03-12-2018

[30] 03-06-2018 / US / 29/649,907

[51] Cl. 14-04

[54] 用於電子裝置的圖形用戶界面

Graphical user interface for electronic device

[73] 蘋果公司

APPLE INC.

ONE APPLE PARK WAY,

CUPERTINO, CALIFORNIA 95014,

UNITED STATES

[74] CLT Patent & Trademark (H.K.) Ltd.

Unit 09, 34/F., Office Tower, Convention Plaza,

No. 1 Harbour Road, Wanchai,

Hong Kong.



---

[11] 1802378.2M007

[15] 03-12-2018

[30] 03-06-2018 / US / 29/649,907

[51] Cl. 14-04

[54] 用於電子裝置的圖形用戶界面

Graphical user interface for electronic device

[73] 蘋果公司

APPLE INC.

ONE APPLE PARK WAY,

CUPERTINO, CALIFORNIA 95014,

UNITED STATES

[74] CLT Patent & Trademark (H.K.) Ltd.

Unit 09, 34/F., Office Tower, Convention Plaza,

No. 1 Harbour Road, Wanchai,

Hong Kong.

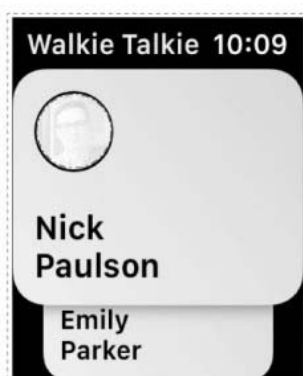

---

[11] 1802378.2M008

[15] 03-12-2018

[30] 03-06-2018 / US / 29/649,907

[51] Cl. 14-04

[54] 用於電子裝置的圖形用戶界面  
Graphical user interface for electronic device

[73] 蘋果公司  
APPLE INC.  
ONE APPLE PARK WAY,  
CUPERTINO, CALIFORNIA 95014,  
UNITED STATES

[74] CLT Patent & Trademark (H.K.) Ltd.  
Unit 09, 34/F., Office Tower, Convention Plaza,  
No. 1 Harbour Road, Wanchai,  
Hong Kong.

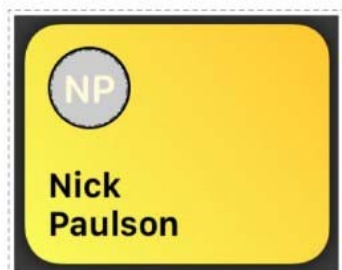

---

[11] 1802378.2M009

[15] 03-12-2018

[30] 03-06-2018 / US / 29/649,907

[51] Cl. 14-04

[54] 用於電子裝置的圖形用戶界面  
Graphical user interface for electronic device

[73] 蘋果公司  
APPLE INC.  
ONE APPLE PARK WAY,  
CUPERTINO, CALIFORNIA 95014,  
UNITED STATES

[74] CLT Patent & Trademark (H.K.) Ltd.  
Unit 09, 34/F., Office Tower, Convention Plaza,  
No. 1 Harbour Road, Wanchai,  
Hong Kong.

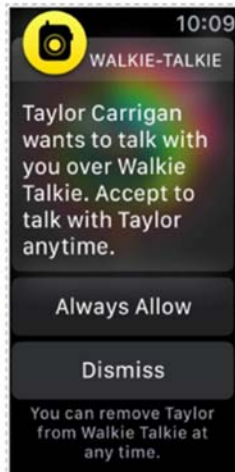

---

[11] 1802378.2M010

[15] 03-12-2018

[30] 03-06-2018 / US / 29/649,907

[51] Cl. 14-04

[54] 用於電子裝置的圖形用戶界面

Graphical user interface for electronic device

[73] 蘋果公司

APPLE INC.

ONE APPLE PARK WAY,

CUPERTINO, CALIFORNIA 95014,

UNITED STATES

[74] CLT Patent & Trademark (H.K.) Ltd.

Unit 09, 34/F., Office Tower, Convention Plaza,

No. 1 Harbour Road, Wanchai,

Hong Kong.



[11] 1802378.2M011

[15] 03-12-2018

[30] 03-06-2018 / US / 29/649,907

[51] Cl. 14-04

[54] 用於電子裝置的動態圖形用戶界面

Animated graphical user interface for electronic device

[73] 蘋果公司

APPLE INC.

ONE APPLE PARK WAY,

CUPERTINO, CALIFORNIA 95014,

UNITED STATES

[74] CLT Patent & Trademark (H.K.) Ltd.

Unit 09, 34/F., Office Tower, Convention Plaza,

No. 1 Harbour Road, Wanchai,

Hong Kong.



[11] 1802378.2M012

[15] 03-12-2018

[30] 03-06-2018 / US / 29/649,907

[51] Cl. 14-04

[54] 用於電子裝置的動態圖形用戶界面

Animated graphical user interface for electronic device

[73] 蘋果公司

APPLE INC.

ONE APPLE PARK WAY,

CUPERTINO, CALIFORNIA 95014,

UNITED STATES

[74] CLT Patent & Trademark (H.K.) Ltd.

Unit 09, 34/F., Office Tower, Convention Plaza,

No. 1 Harbour Road, Wanchai,

Hong Kong.





[11] 1802412.5

[15] 07-12-2018

[51] Cl. 9-03

[54] 牙刷包裝盒

Packaging for toothbrush

[73] 劉華珍

香港九龍

新蒲崗大有街 2 號 旺景工業大

樓 10 樓 E-02 室

[74] 劉華珍

香港新蒲崗大有街 旺景工業

大樓 10 樓 E-02 室



[11] 1802426.5

[15] 10-12-2018

[51] Cl. 20-02

[54] 展示盒

Display box

[73] BOXZES LIMITED

10/F, Cheung Hing Industrial Building,  
12P Smithfield Road, Kennedy Town,  
Hong Kong

[74] Accolade IP Limited

Room 702, 7/F.,  
Fu Fai Commercial Centre,  
27 Hillier Street, Hong Kong.



---

[11] 1802446.7

[15] 12-12-2018

[51] Cl. 9-03

[54] 包裝盒

Packaging

[73] 4M Industrial Development Limited

Suite 2104-7, Shui On Centre,  
6-8 Harbour Road,  
Wanchai, Hong Kong

[74] Deacons

5th Floor,  
Alexandra House,  
Central, Hong Kong.



[11] 1802448.1

[15] 12-12-2018

[51] Cl. 21-01

[54] 帶有棋子和卡牌的教育系統

Educational system with token and cards

[73] 4M Industrial Development Limited

Suite 2104-7, Shui On Centre,

6-8 Harbour Road,

Wanchai, Hong Kong

[74] Deacons

5th Floor,

Alexandra House,

Central, Hong Kong.



[11] 1802472.1

[15] 17-12-2018

[30] 19-06-2018 / DE / 40 2018 100 599.1

[51] Cl. 21-01

[54] 玩具汽車

Toy vehicle

[73] VOLKSWAGEN AKTIENGESELLSCHAFT

38436 WOLFSBURG,

GERMANY

[74] China Patent Agent (H.K.) Ltd.

22/F, Great Eagle Centre,

23 Harbour Road, Wanchai,

Hong Kong.



---

[11] 1802474.5M001

[15] 17-12-2018

[30] 19-06-2018 / DE / 40 2018 100 599.1

[51] Cl. 12-08

[54] 汽車

Motor vehicle

[73] VOLKSWAGEN AKTIENGESELLSCHAFT

38436 WOLFSBURG,

GERMANY

[74] China Patent Agent (H.K.) Ltd.

22/F, Great Eagle Centre,

23 Harbour Road, Wanchai,

Hong Kong.



---

[11] 1802474.5M002

[15] 17-12-2018

[30] 19-06-2018 / DE / 40 2018 100 599.1

[51] Cl. 12-08

[54] 汽車

Motor vehicle

[73] VOLKSWAGEN AKTIENGESELLSCHAFT

38436 WOLFSBURG,

GERMANY

[74] China Patent Agent (H.K.) Ltd.

22/F, Great Eagle Centre,

23 Harbour Road, Wanchai,

Hong Kong.



---

[11] 1802474.5M003

[15] 17-12-2018

[30] 19-06-2018 / DE / 40 2018 100 599.1

[51] Cl. 12-08

[54] 汽車

Motor vehicle

[73] VOLKSWAGEN AKTIENGESELLSCHAFT

38436 WOLFSBURG,

GERMANY

[74] China Patent Agent (H.K.) Ltd.

22/F, Great Eagle Centre,

23 Harbour Road, Wanchai,

Hong Kong.



---

[11] 1802492.3

[15] 19-12-2018

[51] Cl. 9-03

[54] 盒子

Box

[73] 呂佩橋

香港西環

干諾道西 188 號

香港商業中心 36 樓 02-09 室

[74] 呂佩橋

香港西環 香港干諾道

西 188 號

香港商業中心 36 樓 02-09 室



[11] 1802496.2

[15] 20-12-2018

[51] Cl. 3-01

[54] 袋

Bag

[73] LOUIS VUITTON MALLETIER

2, rue du Pont-Neuf 75001 Paris,

FRANCE

[74] BAKER & MCKENZIE

14th Floor, One Taikoo Place

979 King's Road, Quarry Bay

HONG KONG

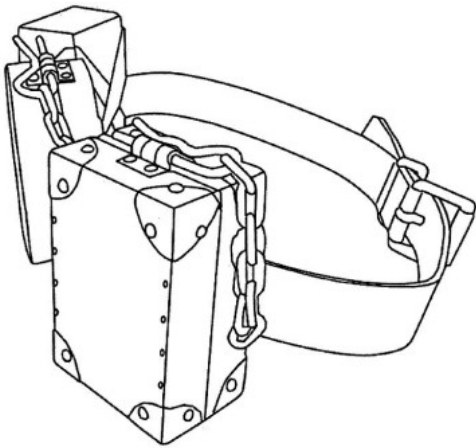

---

[11] 1802496.2

[15] 20-12-2018

[51] Cl. 3-01

[54] 袋

Bag

[73] LOUIS VUITTON MALLETIER

2, rue du Pont-Neuf 75001 Paris,  
FRANCE

[74] BAKER & MCKENZIE

14th Floor, One Taikoo Place  
979 King's Road, Quarry Bay  
HONG KONG

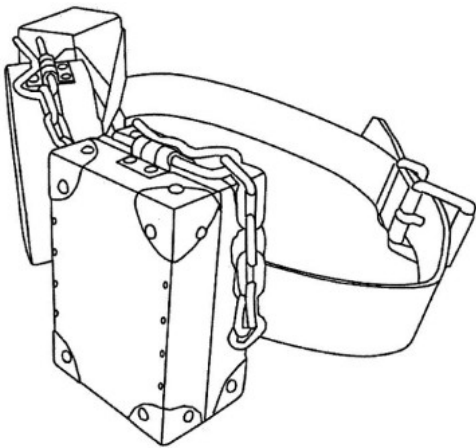

---

[11] 1802522.9

[15] 21-12-2018

[30] 19-11-2018 / CN / 201830657791.4

[51] Cl. 13-03

[54] 多功能轉化器

Multi-function converter

[73] 廣東高普達集團股份有限公司

中國內地廣東省深圳市

龍華新區大浪街道同勝社區華榮路 聯

建科技工業園廠房 8 棟 4,5,6 樓

[74] 中一聯合國際知識產權有限公司

香港九龍尖沙咀

漆咸道南 45-51 號

其士大廈 803 室



---

[11] 1802524.3

[15] 21-12-2018

[51] Cl. 12-08

[54] 車輛塗裝

Vehicle livery

[73] HARVEST HEART LIMITED

Room 12, 8/F, Block B,

Hunghom Commercial Centre,

37 Ma Tau Wai Road, Kowloon, Hong Kong

[74] Accolade IP Limited

Room 702, 7/F.,

Fu Fai Commercial Centre,

27 Hillier Street, Hong Kong.



---

[11] 1802532.0M001

[15] 24-12-2018

[30] 26-06-2018 / US / 29/654,659

[51] Cl. 19-06



[54] 鉛筆

Pencil

[73] 蘋果公司

APPLE INC.

ONE APPLE PARK WAY,

CUPERTINO, CALIFORNIA 95014,

UNITED STATES

[74] CLT Patent & Trademark (H.K.) Ltd.

Unit 09, 34/F., Office Tower,

Convention Plaza, No. 1 Harbour Road,

Wanchai, Hong Kong.



---

[11] 1802532.0M002

[15] 24-12-2018

[30] 26-06-2018 / US / 29/654,659

[51] Cl. 19-06

[54] 鉛筆

Pencil

[73] 蘋果公司

APPLE INC.

ONE APPLE PARK WAY,

CUPERTINO, CALIFORNIA 95014,

UNITED STATES

[74] CLT Patent & Trademark (H.K.) Ltd.

Unit 09, 34/F., Office Tower,

Convention Plaza, No. 1 Harbour Road,

Wanchai, Hong Kong.



[11] 1802532.0M003

[15] 24-12-2018

[30] 26-06-2018 / US / 29/654,659

[51] Cl. 19-06

[54] 鉛筆

Pencil

[73] 蘋果公司

APPLE INC.

ONE APPLE PARK WAY,

CUPERTINO, CALIFORNIA 95014,

UNITED STATES

[74] CLT Patent & Trademark (H.K.) Ltd.

Unit 09, 34/F., Office Tower,

Convention Plaza, No. 1 Harbour Road,

Wanchai, Hong Kong.



---

[11] 1802532.0M004

[15] 24-12-2018

[30] 26-06-2018 / US / 29/654,659

[51] Cl. 19-06

[54] 鉛筆

Pencil

[73] 蘋果公司

APPLE INC.

ONE APPLE PARK WAY,

CUPERTINO, CALIFORNIA 95014,

UNITED STATES

[74] CLT Patent & Trademark (H.K.) Ltd.

Unit 09, 34/F., Office Tower,

Convention Plaza, No. 1 Harbour Road,

Wanchai, Hong Kong.



---

[11] 1802532.0M005

[15] 24-12-2018

[30] 26-06-2018 / US / 29/654,659

[51] Cl. 19-06

[54] 鉛筆

Pencil

[73] 蘋果公司

APPLE INC.

ONE APPLE PARK WAY,

CUPERTINO, CALIFORNIA 95014,

UNITED STATES

[74] CLT Patent & Trademark (H.K.) Ltd.

Unit 09, 34/F., Office Tower,

Convention Plaza, No. 1 Harbour Road,

Wanchai, Hong Kong.



---

[11] 1802533.2

[15] 24-12-2018

[51] Cl. 10-02

[54] 錶

Watch

[73] RICHEMONT INTERNATIONAL SA

Route des Biches 10,

CH - 1752 Villars-sur-Glâne,

SWITZERLAND

[74] WENPING & CO.

1701 Tung Wai Commercial Building,

111 Gloucester Road,

Hong Kong.



---

[11] 1802547.2M001

[15] 27-12-2018

[30] 23-08-2018 / US / 29/661,010  
27-06-2018 / US / 29/654,825

[51] Cl. 27-99

[54] 具動畫指示物的噴霧器

Vaporizer device with animated indicator

[73] Juul Labs, Inc.

560 20th Street, Building 104,  
San Francisco, CA 94107,  
UNITED STATES

[74] HONG KONG INTELLECTUAL PROPERTY AGENT LIMITED

Unit 230, 2/F, Building 12W,  
No.12 Science Park West Avenue,  
Phase 3, Hong Kong Science Park, Pak Shek Kok, N.T., Hong  
Kong.



---

[11] 1802547.2M002

[15] 27-12-2018

[30] 23-08-2018 / US / 29/661,010  
27-06-2018 / US / 29/654,825

[51] Cl. 27-99

[54] 具動畫指示物的噴霧器

Vaporizer device with animated indicator

[73] Juul Labs, Inc.

560 20th Street, Building 104,

San Francisco, CA 94107,

UNITED STATES

[74] HONG KONG INTELLECTUAL PROPERTY AGENT LIMITED

Unit 230, 2/F, Building 12W,

No.12 Science Park West Avenue,

Phase 3, Hong Kong Science Park, Pak Shek Kok, N.T., Hong

Kong.



---

[11] 1802547.2M003

[15] 27-12-2018

[30] 23-08-2018 / US / 29/661,010

27-06-2018 / US / 29/654,825

[51] Cl. 27-99

[54] 具動畫指示物的噴霧器

Vaporizer device with animated indicator

[73] Juul Labs, Inc.

560 20th Street, Building 104,

San Francisco, CA 94107,

UNITED STATES

[74] HONG KONG INTELLECTUAL PROPERTY AGENT LIMITED

Unit 230, 2/F, Building 12W,

No.12 Science Park West Avenue,

Phase 3, Hong Kong Science Park, Pak Shek Kok, N.T., Hong

Kong.



---

[11] 1802547.2M004

[15] 27-12-2018

[30] 23-08-2018 / US / 29/661,010  
27-06-2018 / US / 29/654,825

[51] Cl. 27-99

[54] 具動畫指示物的噴霧器

Vaporizer device with animated indicator

[73] Juul Labs, Inc.

560 20th Street, Building 104,

San Francisco, CA 94107,

UNITED STATES

[74] HONG KONG INTELLECTUAL PROPERTY AGENT LIMITED

Unit 230, 2/F, Building 12W,

No.12 Science Park West Avenue,

Phase 3, Hong Kong Science Park, Pak Shek Kok, N.T., Hong

Kong.



---

[11] 1802547.2M005

[15] 27-12-2018

[30] 23-08-2018 / US / 29/661,010  
27-06-2018 / US / 29/654,825

[51] Cl. 27-99

[54] 具動畫指示物的噴霧器

Vaporizer device with animated indicator

[73] Juul Labs, Inc.

560 20th Street, Building 104,

San Francisco, CA 94107,

UNITED STATES

[74] HONG KONG INTELLECTUAL PROPERTY AGENT LIMITED

Unit 230, 2/F, Building 12W,

No.12 Science Park West Avenue,

Phase 3, Hong Kong Science Park, Pak Shek Kok, N.T., Hong

Kong.



---

[11] 1802547.2M006

[15] 27-12-2018

[30] 23-08-2018 / US / 29/661,010

27-06-2018 / US / 29/654,825

[51] Cl. 27-99

[54] 具動畫指示物的噴霧器

Vaporizer device with animated indicator

[73] Juul Labs, Inc.

560 20th Street, Building 104,

San Francisco, CA 94107,

UNITED STATES

[74] HONG KONG INTELLECTUAL PROPERTY AGENT LIMITED

Unit 230, 2/F, Building 12W,

No.12 Science Park West Avenue,

Phase 3, Hong Kong Science Park, Pak Shek Kok, N.T., Hong

Kong.



---

[11] 1802547.2M007

[15] 27-12-2018

[30] 23-08-2018 / US / 29/661,010  
27-06-2018 / US / 29/654,825

[51] Cl. 27-99

[54] 具動畫指示物的噴霧器

Vaporizer device with animated indicator

[73] Juul Labs, Inc.

560 20th Street, Building 104,  
San Francisco, CA 94107,  
UNITED STATES

[74] HONG KONG INTELLECTUAL PROPERTY AGENT LIMITED

Unit 230, 2/F, Building 12W,  
No.12 Science Park West Avenue,  
Phase 3, Hong Kong Science Park, Pak Shek Kok, N.T., Hong  
Kong.



---

[11] 1802547.2M008

[15] 27-12-2018

[30] 23-08-2018 / US / 29/661,010  
27-06-2018 / US / 29/654,825



[51] Cl. 27-99

[54] 具動畫指示物的噴霧器

Vaporizer device with animated indicator

[73] Juul Labs, Inc.

560 20th Street, Building 104,

San Francisco, CA 94107,

UNITED STATES

[74] HONG KONG INTELLECTUAL PROPERTY AGENT LIMITED

Unit 230, 2/F, Building 12W,

No.12 Science Park West Avenue,

Phase 3, Hong Kong Science Park, Pak Shek Kok, N.T., Hong

Kong.



---

[11] 1802547.2M009

[15] 27-12-2018

[30] 23-08-2018 / US / 29/661,010

27-06-2018 / US / 29/654,825

[51] Cl. 27-99

[54] 具動畫指示物的噴霧器

Vaporizer device with animated indicator

[73] Juul Labs, Inc.

560 20th Street, Building 104,

San Francisco, CA 94107,

UNITED STATES

[74] HONG KONG INTELLECTUAL PROPERTY AGENT LIMITED

Unit 230, 2/F, Building 12W,

No.12 Science Park West Avenue,

Phase 3, Hong Kong Science Park, Pak Shek Kok, N.T., Hong

Kong.



---

[11] 1802547.2M010

[15] 27-12-2018

[30] 23-08-2018 / US / 29/661,010  
27-06-2018 / US / 29/654,825

[51] Cl. 27-99

[54] 具動畫指示物的噴霧器

Vaporizer device with animated indicator

[73] Juul Labs, Inc.

560 20th Street, Building 104,  
San Francisco, CA 94107,  
UNITED STATES

[74] HONG KONG INTELLECTUAL PROPERTY AGENT LIMITED

Unit 230, 2/F, Building 12W,  
No.12 Science Park West Avenue,  
Phase 3, Hong Kong Science Park, Pak Shek Kok, N.T., Hong  
Kong.



---

[11] 1802547.2M011

[15] 27-12-2018

[30] 23-08-2018 / US / 29/661,010  
27-06-2018 / US / 29/654,825

[51] Cl. 27-99

[54] 具動畫指示物的噴霧器

Vaporizer device with animated indicator

[73] Juul Labs, Inc.  
560 20th Street, Building 104,  
San Francisco, CA 94107,  
UNITED STATES

[74] HONG KONG INTELLECTUAL PROPERTY AGENT LIMITED  
Unit 230, 2/F, Building 12W,  
No.12 Science Park West Avenue,  
Phase 3, Hong Kong Science Park, Pak Shek Kok, N.T., Hong  
Kong.



---

[11] 1802547.2M012

[15] 27-12-2018

[30] 23-08-2018 / US / 29/661,010  
27-06-2018 / US / 29/654,825

[51] Cl. 27-99

[54] 具動畫指示物的噴霧器  
Vaporizer device with animated indicator

[73] Juul Labs, Inc.  
560 20th Street, Building 104,  
San Francisco, CA 94107,  
UNITED STATES

[74] HONG KONG INTELLECTUAL PROPERTY AGENT LIMITED  
Unit 230, 2/F, Building 12W,  
No.12 Science Park West Avenue,  
Phase 3, Hong Kong Science Park, Pak Shek Kok, N.T., Hong  
Kong.



---

[11] 1802547.2M013

[15] 27-12-2018

[30] 23-08-2018 / US / 29/661,010  
27-06-2018 / US / 29/654,825

[51] Cl. 27-99

[54] 具動畫指示物的噴霧器

Vaporizer device with animated indicator

[73] Juul Labs, Inc.

560 20th Street, Building 104,

San Francisco, CA 94107,

UNITED STATES

[74] HONG KONG INTELLECTUAL PROPERTY AGENT LIMITED

Unit 230, 2/F, Building 12W,

No.12 Science Park West Avenue,

Phase 3, Hong Kong Science Park, Pak Shek Kok, N.T., Hong

Kong.



---

[11] 1802547.2M014

[15] 27-12-2018

[30] 23-08-2018 / US / 29/661,010  
27-06-2018 / US / 29/654,825

[51] Cl. 27-99

[54] 具動畫指示物的噴霧器

Vaporizer device with animated indicator

[73] Juul Labs, Inc.

560 20th Street, Building 104,

San Francisco, CA 94107,

UNITED STATES

[74] HONG KONG INTELLECTUAL PROPERTY AGENT LIMITED

Unit 230, 2/F, Building 12W,

No.12 Science Park West Avenue,

Phase 3, Hong Kong Science Park, Pak Shek Kok, N.T., Hong

Kong.



---

[11] 1802547.2M015

[15] 27-12-2018

[30] 23-08-2018 / US / 29/661,010

27-06-2018 / US / 29/654,825

[51] Cl. 27-99

[54] 具動畫指示物的噴霧器

Vaporizer device with animated indicator

[73] Juul Labs, Inc.

560 20th Street, Building 104,

San Francisco, CA 94107,

UNITED STATES

[74] HONG KONG INTELLECTUAL PROPERTY AGENT LIMITED

Unit 230, 2/F, Building 12W,

No.12 Science Park West Avenue,

Phase 3, Hong Kong Science Park, Pak Shek Kok, N.T., Hong

Kong.



---

[11] 1802547.2M016

[15] 27-12-2018

[30] 23-08-2018 / US / 29/661,010  
27-06-2018 / US / 29/654,825

[51] Cl. 27-99

[54] 具動畫指示物的噴霧器

Vaporizer device with animated indicator

[73] Juul Labs, Inc.

560 20th Street, Building 104,

San Francisco, CA 94107,

UNITED STATES

[74] HONG KONG INTELLECTUAL PROPERTY AGENT LIMITED

Unit 230, 2/F, Building 12W,

No.12 Science Park West Avenue,

Phase 3, Hong Kong Science Park, Pak Shek Kok, N.T., Hong

Kong.



---

[11] 1802547.2M017

[15] 27-12-2018

[30] 23-08-2018 / US / 29/661,010  
27-06-2018 / US / 29/654,825

[51] Cl. 27-99

[54] 具動畫指示物的噴霧器

Vaporizer device with animated indicator

[73] Juul Labs, Inc.

560 20th Street, Building 104,

San Francisco, CA 94107,

UNITED STATES

[74] HONG KONG INTELLECTUAL PROPERTY AGENT LIMITED

Unit 230, 2/F, Building 12W,

No.12 Science Park West Avenue,

Phase 3, Hong Kong Science Park, Pak Shek Kok, N.T., Hong

Kong.



---

[11] 1802547.2M018

[15] 27-12-2018

[30] 23-08-2018 / US / 29/661,010

27-06-2018 / US / 29/654,825

[51] Cl. 27-99

[54] 具動畫指示物的噴霧器

Vaporizer device with animated indicator

[73] Juul Labs, Inc.

560 20th Street, Building 104,

San Francisco, CA 94107,

UNITED STATES

[74] HONG KONG INTELLECTUAL PROPERTY AGENT LIMITED

Unit 230, 2/F, Building 12W,

No.12 Science Park West Avenue,

Phase 3, Hong Kong Science Park, Pak Shek Kok, N.T., Hong

Kong.



---

[11] 1802547.2M020

[15] 27-12-2018

[30] 23-08-2018 / US / 29/661,010  
27-06-2018 / US / 29/654,825

[51] Cl. 27-99

[54] 具動畫指示物的噴霧器

Vaporizer device with animated indicator

[73] Juul Labs, Inc.

560 20th Street, Building 104,

San Francisco, CA 94107,

UNITED STATES

[74] HONG KONG INTELLECTUAL PROPERTY AGENT LIMITED

Unit 230, 2/F, Building 12W,

No.12 Science Park West Avenue,

Phase 3, Hong Kong Science Park, Pak Shek Kok, N.T., Hong

Kong.



---

[11] 1802548.4

[15] 27-12-2018

[51] Cl. 23-04



[54] 香薰機

Aroma diffuser

[73] Bloomy Lotus Ltd

Unit 4711, 47/F., The Center,  
99 Queen's Road Central,  
Central, Hong Kong

[74] FEDERATION OF HONG KONG INDUSTRIES

31/F, BILLION PLAZA,  
8 CHEUNG YUE STREET,  
CHEUNG SHA WAN, KOWLOON, HONG KONG



---

[11] 1802549.6

[15] 27-12-2018

[51] Cl. 23-04

[54] 香薰機

Aroma diffuser

[73] Bloomy Lotus Ltd

Unit 4711, 47/F., The Center,  
99 Queen's Road Central,  
Central, Hong Kong

[74] FEDERATION OF HONG KONG INDUSTRIES

31/F, BILLION PLAZA,  
8 CHEUNG YUE STREET,  
CHEUNG SHA WAN, KOWLOON, HONG KONG



---

[11] 1802550.8

[15] 27-12-2018

[30] 30-11-2018 / CN / 201830689283.4

[51] Cl. 13-03

[54] 多功能轉換器

Multi-function converter

[73] 廣東高普達集團股份有限公司

中國內地廣東省深圳市龍華新區

大浪街道同勝社區華榮路 聯建科技工

業園廠房 8 棟 4,5,6 樓

[74] 中一聯合國際知識產權有限公司

香港九龍尖沙咀

漆咸道南 45-51 號

其士大廈 803 室



---

[11] 1802551.0M001

[15] 27-12-2018

[30] 30-11-2018 / CN / 201830689286.8

[51] Cl. 13-02

[54] 適配器

Adapter

[73] 廣東高普達集團股份有限公司 中國

內地廣東省深圳市龍華新區 大浪街

道同勝社區華榮路 聯建科技工業園

廠房 8 棟 4,5,6 樓

[74] 中一聯合國際知識產權有限公司

香港九龍尖沙咀

漆咸道南 45-51 號

其士大廈 803 室



---

[11] 1802551.0M002

[15] 27-12-2018

[30] 30-11-2018 / CN / 201830689286.8

[51] Cl. 13-02

[54] 適配器

Adapter

[73] 廣東高普達集團股份有限公司 中國  
內地廣東省深圳市龍華新區 大浪街  
道同勝社區華榮路 聯建科技工業園  
廠房 8 棟 4,5,6 樓

[74] 中一聯合國際知識產權有限公司  
香港九龍尖沙咀  
漆咸道南 45-51 號  
其士大廈 803 室



---

[11] 1802558.5

[15] 28-12-2018

[51] Cl. 21-01

[54] 積木玩具

Toy building block

[73] Royal Toys (HK) Co., Limited  
香港新界荃灣 橫  
龍街 55-57 號  
利時工業大廈 7 樓

[74] Royal Toys (HK) Co., Limited  
香港新界荃灣 橫  
龍街 55-57 號  
利時工業大廈 7 樓



---

[11] 1802559.7

[15] 28-12-2018

[51] Cl. 21-01

[54] 積木玩具

Toy building block

[73] Royal Toys (HK) Co., Limited

香港新界荃灣 橫

龍街 55-57 號

利時工業大廈 7 樓

[74] Royal Toys (HK) Co., Limited

香港新界荃灣 橫

龍街 55-57 號

利時工業大廈 7 樓



---

[11] 1802560.9

[15] 28-12-2018

[30] 28-06-2018 / CN / 201830341811.7

[51] Cl. 12-07

[54] 無人機

Unmanned aerial vehicle

[73] 北京京東尚科信息技術有限公司  
BEIJING JINGDONG SHANGKE INFORMATION TECHNOLOGY CO., LTD.  
中國內地 北京市  
海淀區 知春路 76  
號 8 層

北京京東世紀貿易有限公司  
BEIJING JINGDONG CENTURY TRADING CO., LTD.  
中國內地 北京市  
大興區  
北京經濟技術開發區科創十一街 18 號 C 座 2 層 201 室

[74] 隆天專利商標代理有限公司  
香港九龍  
青山道 485 號  
九龍廣場 10 樓 11 室

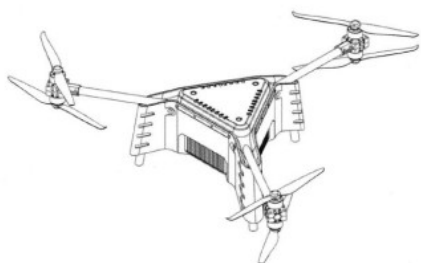

- 
- [11] 1802568.6  
[15] 28-12-2018  
[30] 20-12-2018 / CN / 201830743502.2  
[51] C1. 3-04  
[54] 風扇  
Fan  
[73] 深圳市同創創精密電子有限公司  
中國內地深圳市 寶安區西鄉街道  
三圍華豐 第一科技園 B 區一棟三  
樓、八樓北  
[74] 金信智權有限公司  
香港  
觀塘偉業街 221 號 美德工業大  
廈 D 座 10/F 38 室



---

[11] 1802569.8

[15] 28-12-2018

[30] 29-06-2018 / JP / 014383 of 2018

[51] Cl. 14-02

[54] 數字內容再生裝置

Digital content reproduction apparatus

[73] GATEBOX INC.

NREG akihabara Bld. 7F, 1-8-13,  
Sotokanda, Chiyoda-ku, Tokyo 1010021,  
JAPAN

[74] Barron & Young Intellectual Property Limited

Suite 617, Lakeside 2,  
No. 10 Science Park West Avenue,  
Hong Kong Science Park, N.T., Hong Kong.



---

[11] 1802574.8

[15] 29-12-2018

[30] 06-12-2018 / CN / 201830702382.1

[51] Cl. 13-02

[54] 無線充電器

Wireless charger

[73] 廣東高普達集團股份有限公司 中國內地廣東省深圳市 龍華新區大浪街道同勝社區華榮路 聯建科技工業園廠房 8 棟 4、5、6 樓

[74] 中一聯合國際知識產權有限公司  
香港九龍尖沙咀  
漆咸道南 45-51 號  
其士大廈 803 室



---

[11] 1802575.1

[15] 29-12-2018

[30] 06-12-2018 / CN / 201830702291.8

[51] Cl. 13-02

[54] 移動電源

Portable power source

[73] 廣東高普達集團股份有限公司  
中國內地廣東省深圳市  
龍華新區大浪街道同勝社區華榮路 聯建科技工業園廠房 8 棟 4、5、6 樓

[74] 中一聯合國際知識產權有限公司  
香港九龍尖沙咀  
漆咸道南 45-51 號  
其士大廈 803 室



---

[11] 1802577.5

- [15] 29-12-2018
- [30] 06-12-2018 / CN / 201830702280.X
- [51] C1. 13-02
- [54] 無線充電器  
Wireless charger
- [73] 廣東高普達集團股份有限公司 中國內地廣東省深圳市 龍華新區大浪街道同勝社區華榮路 聯建科技工業園廠房 8 棟 4、5、6 樓
- [74] 中一聯合國際知識產權有限公司  
香港九龍尖沙咀  
漆咸道南 45-51 號  
其士大廈 803 室



- 
- [11] 1802578.7
- [15] 29-12-2018
- [30] 06-12-2018 / CN / 201830702277.8
- [51] C1. 13-02
- [54] 無線充電器  
Wireless charger
- [73] 廣東高普達集團股份有限公司 中國內地廣東省深圳市 龍華新區大浪街道同勝社區華榮路 聯建科技工業園廠房 8 棟 4、5、6 樓
- [74] 中一聯合國際知識產權有限公司  
香港九龍尖沙咀  
漆咸道南 45-51 號  
其士大廈 803 室





---

[11] 1802579.9

[15] 31-12-2018

[30] 04-07-2018 / EM / 005401528

[51] Cl. 3-01

[54] 袋

Bag

[73] FURLA S.p.A.

Via Bellaria, 3-5,

I-40068 San Lazzaro di Savena (Bologna),

ITALY

[74] Barron & Young Intellectual Property Limited

Suite 617, Lakeside 2,

No. 10 Science Park West Avenue,

Hong Kong Science Park, N.T., Hong Kong.



---

[11] 1802582.5

[15] 31-12-2018

[30] 29-12-2018 / CN / 201830772066.1

[51] Cl. 10-05

[54] 自動閘門

Automated gate

- [73] 航天信息股份有限公司  
中國內地北京市 海澱區  
杏石口路甲 18 號
- [74] 陳偉傑知識產權有限公司  
香港上環  
蘇杭街 23 號 永昌商業大廈 10 樓 D 室



- 
- [11] 1802583.7
- [15] 31-12-2018
- [51] Cl. 13-02
- [54] 黑匣子儲能電源  
Black box power station
- [73] 深圳派立通科技有限公司  
Shenzhen Pilot Technology Co., LTD  
中國內地廣東省深圳市龍崗區 平湖街道山廈社區杉坑工業區杉坑路 7 號 A1 廠房二樓、三樓  
(在杉坑三路 B20 廠房一樓、三樓、四樓設有經營場所)
- [74] 中港專利有限公司  
香港港灣道 1 號  
會展廣場辦公大樓  
30 樓 3012 室



- 
- [11] 1900009.0
- [15] 02-01-2019

[30] 18-10-2018 / EM / 005801651-0004

[51] Cl. 7-02

[54] 煮食勺子

Cooking ladle

[73] Brabantia Nederland B.V.

De Haak 14,

5555 XK Valkenswaard,

NETHERLANDS

[74] NTD Patent & Trade Mark Agency Ltd.

Units 1805-6, 18/F., Greenfield Tower,

Concordia Plaza, No.1 Science Museum Road,

Tsimshatsui East, Kowloon, Hong Kong.



---

[11] 1900011.4

[15] 02-01-2019

[30] 02-07-2018 / EM / 005352507

[51] Cl. 3-01

[54] 包

Bag

[73] INTERBASIC HOLDING S.R.L.

STRADA SETTECAMINI 116 I-63811 SANT'ELPIDIO A MARE (FERMO)

ITALY,

ITALY

[74] China Patent Agent (H.K.) Ltd.

22/F, Great Eagle Centre,

23 Harbour Road, Wanchai,

Hong Kong.



---

[11] 1900012.6

[15] 02-01-2019

[30] 02-07-2018 / EM / 005352507

[51] Cl. 8-07

[54] 用於包的扣環

Clasp for bags

[73] INTERBASIC HOLDING S.R.L.

STRADA SETTECAMINI 116 I-63811 SANT'ELPIDIO A MARE (FERMO)

ITALY,

ITALY

[74] China Patent Agent (H.K.) Ltd.

22/F, Great Eagle Centre,

23 Harbour Road, Wanchai,

Hong Kong.



---

[11] 1900014.0

[15] 02-01-2019

[30] 16-07-2018 / CN / 201830383118.6

[51] Cl. 23-04

[54] 空氣淨化器

Air purifier

[73] REHAU Limited  
Level 8 Admiralty Centre Tower II,  
18 Harcourt Rd, Admiralty,  
Hong Kong

[74] Wilkinson & Grist  
6th Floor, Prince's Building,  
Chater Road,  
Hong Kong.



---

[11] 1900021.5

[15] 03-01-2019

[51] Cl. 14-01

[54] 耳機

Headphone

[73] 一兆數碼科技（深圳）有限公司  
Yizhao Digital Technology (Shenzhen) co., Ltd  
中國內地廣東省深圳市寶安區  
西鄉街道寶安大道 5010 號  
佳兆納創意大廈 6 樓 601

[74] 千里馬知識產權有限公司  
香港新界荃灣  
白田壩街 36-44 號 信義  
工業大廈 9 樓 A3 室



[11] 1900027.8

[15] 04-01-2019

[51] Cl. 3-01

[54] 袋

Handbag

[73] Seekerz Summit Limited

Room 2301, 23/F., Futura Plaza,  
111-113 How Ming Street, Kwun Tong,  
Kowloon, Hong Kong

[74] Seekerz Summit Limited

Room 2301, 23/F., Futura Plaza,  
111-113 How Ming Street, Kwun Tong,  
Kowloon, Hong Kong



---

[11] 1900032.8

[15] 07-01-2019

[30] 12-07-2018 / US / 29/656,444

[51] Cl. 14-01

[54] 耳機

Headphone

[73] Skullcandy, Inc.

6301 N. Landmark Dr. Park City,  
UT 84098,  
UNITED STATES

[74] CLT Patent & Trademark (H.K.) Ltd.

Unit 09, 34/F., Office Tower,  
Convention Plaza, No. 1 Harbour Road,  
Wanchai, Hong Kong.



- 
- [11] 1900035.5  
[15] 08-01-2019  
[30] 10-07-2018 / EM, MA, SG, CH, TR / DM/102 077  
[51] Cl. 10-07  
[54] 錶面  
Watch dial  
[73] CARTIER INTERNATIONAL AG  
Hinterbergstrasse 22,  
6312 Steinhausen,  
SWITZERLAND  
[74] WENPING & CO.  
1701 Tung Wai Commercial Building,  
111 Gloucester Road,  
Hong Kong.



- 
- [11] 1900041.7  
[15] 09-01-2019  
[51] Cl. 9-05  
[54] 化妝品用軟管包裝  
Packaging tube for cosmetics

[73] COLOURMIX COSMETICS COMPANY LIMITED  
10TH Floor, Wyler Centre Phase II,  
192-200 Tai Lin Pai Road, Kwai Chung,  
New Territories, Hong Kong.

[74] Markpal IP Limited  
Unit A, 11/F Amtel Building,  
144-148 Des Voeux Road Central,  
Hong Kong.



---

[11] 1900042.9

[15] 09-01-2019

[51] Cl. 9-03

[54] 包裝盒  
Packing box

[73] 高遠  
香港九龍  
大有街 1 號  
勤達中心 1207 室

[74] 卓遠知識產權有限公司  
香港上環  
禧利街 27 號  
富輝商業中心 7 樓 701-702 室





- [11] 1900045.6  
[15] 09-01-2019  
[30] 05-11-2018 / EM / 005816899-0001  
[51] Cl. 2-04  
[54] 鞋  
Shoes  
[73] adidas AG  
Adi-Dassler-Strasse 1,  
91074 Herzogenaurach,  
GERMANY  
[74] Mayer Brown  
16th-19th Floors, Prince's Building,  
10 Chater Road, Central,  
Hong Kong.



- 
- [11] 1900051.8  
[15] 09-01-2019  
[30] 28-12-2018 / CN / 201830764994.3  
[51] Cl. 13-03  
[54] 轉接器  
Adapter  
[73] 廣東高普達集團股份有限公司 中國  
內地廣東省深圳市 龍華新區大浪街  
道同勝社區華榮路 聯建科技工業園  
廠房 8 棟 4,5,6 樓  
[74] 中一聯合國際知識產權有限公司  
香港九龍尖沙咀  
漆咸道南 45-51 號  
其士大廈 803 室



---

[11] 1900056.9

[15] 09-01-2019

[51] Cl. 21-01

[54] 玩具槍

Toy gun

[73] Buzz Bee Toys (HK) Co., Limited

Units 1206-1208, Tower B, New Mandarin Plaza,  
14 Science Museum Road, Tsim Sha Tsui East,  
Kowloon, Hong Kong

[74] INCOMPASS IP LIMITED

532B, 5/F, Core Building 2, Phase One,  
Hong Kong Science Park, Pak Shek Kok, HONG KONG  
HONG KONG



---

[11] 1900057.1

[15] 09-01-2019

[51] Cl. 21-01

[54] 玩具槍

Toy gun

[73] Buzz Bee Toys (HK) Co., Limited

Units 1206-1208, Tower B, New Mandarin Plaza,  
14 Science Museum Road, Tsim Sha Tsui East,  
Kowloon, Hong Kong

[74] INCOMPASS IP LIMITED

532B, 5/F, Core Building 2, Phase One,

Hong Kong Science Park, Pak Shek Kok, HONG KONG  
HONG KONG



---

[11] 1900058.3

[15] 09-01-2019

[51] Cl. 21-01

[54] 玩具槍

Toy gun

[73] Buzz Bee Toys (HK) Co., Limited

Units 1206-1208, Tower B, New Mandarin Plaza,  
14 Science Museum Road, Tsim Sha Tsui East,  
Kowloon, Hong Kong

[74] INCOMPASS IP LIMITED

532B, 5/F, Core Building 2, Phase One,  
Hong Kong Science Park, Pak Shek Kok, HONG KONG  
HONG KONG



---

[11] 1900059.5

[15] 09-01-2019

[51] Cl. 21-01

[54] 玩具槍

Toy gun

[73] Buzz Bee Toys (HK) Co., Limited

Units 1206-1208, Tower B, New Mandarin Plaza,  
14 Science Museum Road, Tsim Sha Tsui East,  
Kowloon, Hong Kong

[74] INCOMPASS IP LIMITED

532B, 5/F, Core Building 2, Phase One,

Hong Kong Science Park, Pak Shek Kok, HONG KONG  
HONG KONG



---

[11] 1900061.9

[15] 09-01-2019

[51] Cl. 21-01

[54] 玩具槍

Toy gun

[73] Buzz Bee Toys (HK) Co., Limited

Units 1206-1208, Tower B, New Mandarin Plaza,  
14 Science Museum Road, Tsim Sha Tsui East,  
Kowloon, Hong Kong

[74] INCOMPASS IP LIMITED

532B, 5/F, Core Building 2, Phase One,  
Hong Kong Science Park, Pak Shek Kok, HONG KONG  
HONG KONG



---

[11] 1900065.8

[15] 10-01-2019

[30] 21-07-2018 / JP / 016006 of 2018

[51] Cl. 28-03

[54] 鍛煉用器具

Training apparatus

[73] 株式會社 MTG

MTG Co., Ltd.  
32, HONJIN-DORI 2-CHOME,  
NAKAMURA-KU, NAGOYA-SHI,  
AICHI-KEN 453-0041, JAPAN

- [74] CHINAHONGKONG IP LIMITED  
3011, 30/F, Office Tower,  
Convention Plaza, 1 Harbour Road,  
Hong Kong.

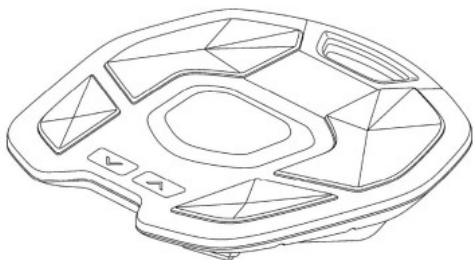

- 
- [11] 1900066.0  
[15] 10-01-2019  
[30] 17-08-2018 / EM / 005612025-0001  
[51] Cl. 2-04  
[54] 鞋  
Shoes
- [73] adidas AG  
Adi-Dassler-Strasse 1,  
91074 Herzogenaurach,  
GERMANY
- [74] Mayer Brown  
16th-19th Floors, Prince's Building,  
10 Chater Road, Central,  
Hong Kong.



- 
- [11] 1900075.9  
[15] 10-01-2019  
[30] 27-07-2018 / CN / 201830411321.X  
[51] Cl. 6-09  
[54] 枕頭  
Pillow

[73] 深圳艾素科技有限公司 中國內地  
廣東省深圳市 寶安區福永街  
道塘尾社區 第二工業區第 8、  
9 棟 518103

[74] 何升偉律師事務所  
香港皇后大道東 28 號  
金鐘匯中心 9 樓 902 室

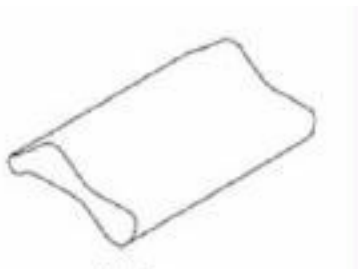

---

[11] 1913059.0

[15] 20-02-2019

[30] 15-01-2019 / TW / 108300277

[51] Cl. 9-03

[54] 盒體展開板之部分  
Part of the box expansion board

[73] 林志勳  
LIN, CHIH-HSUN  
台灣高雄市 鳳  
山區 大東二路  
58 號

[74] 智雅知識產權代理公司  
香港荃灣  
青山道 264-298 號  
南豐中心 1522 室

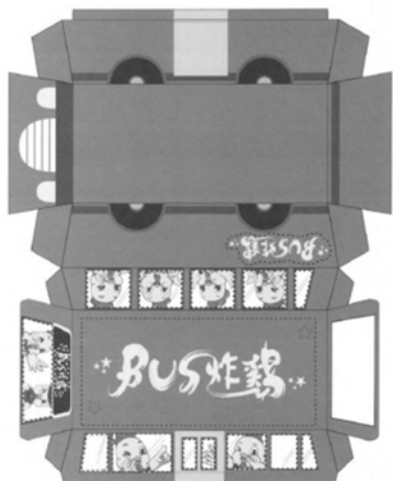

[11] 1913060.2

[15] 20-02-2019

[30] 15-01-2019 / TW / 108300276

[51] C1. 9-03

[54] 盒體展開板之部份

Part of the box expansion board

[73] 林志勳

LIN, CHIN-HSUN

台灣高雄市 鳳

山區 大東二路

58 號

[74] 智雅知識產權代理公司

香港荃灣

青山道 264-298 號

南豐中心 1522 室

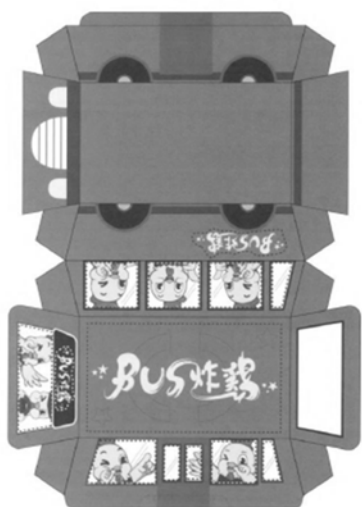

- [11] 1913061.4  
[15] 20-02-2019  
[30] 15-01-2019 / TW / 108300275  
[51] Cl. 7-01  
[54] 餐盒之部分  
Part of the food container  
[73] 林志勳  
LIN, CHIN-HSUN  
台灣高雄市 鳳  
山區 大東二路  
58 號  
[74] 智雅知識產權代理公司  
香港荃灣  
青山道 264-298 號  
南豐中心 1522 室



- 
- [11] 1913069.1  
[15] 21-02-2019  
[30] 31-08-2018 / US / 29/662,028  
[51] Cl. 14-03  
[54] 通訊頭戴式送受話器或耳機  
Communications Headset Or Headphones  
[73] 續特力股份有限公司  
PLANTRONICS, INC.  
345 Encinal St., Santa Cruz, CA 95060  
UNITED STATES  
[74] SHANGHAI INTELLECTUAL PROPERTY OFFICE  
Unit F, 20th Floor, Neich Tower,  
128 Gloucester Road,  
HONG KONG





---

[11] 1913072.7M001

[15] 21-02-2019

[30] 22-08-2018 / US / 29/660,831

[51] Cl. 9-01

[54] 用於採樣裝置的瓶子

VIAL FOR SAMPLING APPARATUS

[73] QUEST DIAGNOSTICS INVESTMENTS LLC

500 PLAZA DRIVE, SECAUCUS, NEW JERSEY 07094

UNITED STATES OF AMERICA

[74] CHINAHONGKONG IP LIMITED

3011, 30/F, Office Tower, Convention Plaza, 1 Harbour Road

HONG KONG

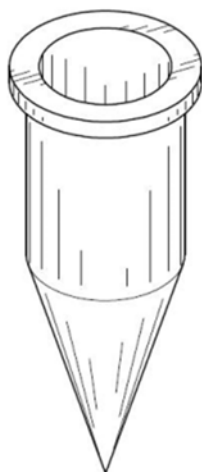

---

[11] 1913072.7M002

[15] 21-02-2019

[30] 22-08-2018 / US / 29/660,831

[51] Cl. 9-01

[54] 用於採樣裝置的瓶子

VIAL FOR SAMPLING APPARATUS

[73] QUEST DIAGNOSTICS INVESTMENTS LLC

500 PLAZA DRIVE, SECAUCUS, NEW JERSEY 07094

UNITED STATES OF AMERICA

[74] CHINAHONGKONG IP LIMITED

3011, 30/F, Office Tower, Convention Plaza, 1 Harbour Road

HONG KONG

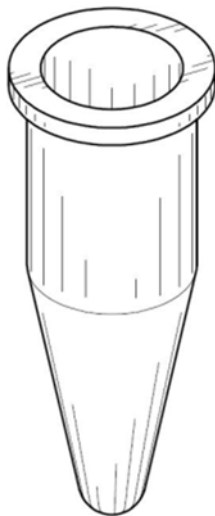

---

[11] 1913072.7M003

[15] 21-02-2019

[30] 22-08-2018 / US / 29/660,831

[51] Cl. 9-01

[54] 用於採樣裝置的瓶子

VIAL FOR SAMPLING APPARATUS

[73] QUEST DIAGNOSTICS INVESTMENTS LLC

500 PLAZA DRIVE, SECAUCUS, NEW JERSEY 07094

UNITED STATES OF AMERICA

[74] CHINAHONGKONG IP LIMITED

3011, 30/F, Office Tower, Convention Plaza, 1 Harbour Road

HONG KONG

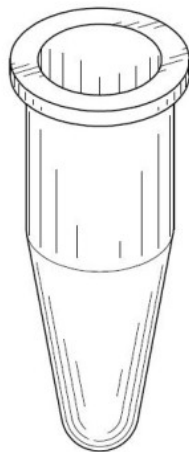

---

[11] 1913072.7M004

[15] 21-02-2019

[30] 22-08-2018 / US / 29/660,831

[51] Cl. 9-01

[54] 用於採樣裝置的瓶子

VIAL FOR SAMPLING APPARATUS

[73] QUEST DIAGNOSTICS INVESTMENTS LLC

500 PLAZA DRIVE, SECAUCUS, NEW JERSEY 07094

UNITED STATES OF AMERICA

[74] CHINAHONGKONG IP LIMITED

3011, 30/F, Office Tower, Convention Plaza, 1 Harbour Road

HONG KONG

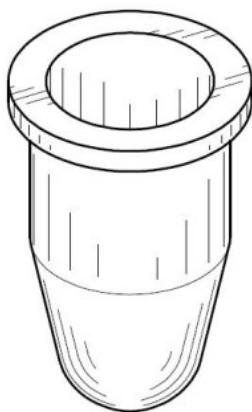

---

[11] 1913072.7M005

[15] 21-02-2019

[30] 22-08-2018 / US / 29/660,831

[51] Cl. 9-01

[54] 用於採樣裝置的瓶子

VIAL FOR SAMPLING APPARATUS

[73] QUEST DIAGNOSTICS INVESTMENTS LLC

500 PLAZA DRIVE, SECAUCUS, NEW JERSEY 07094

UNITED STATES OF AMERICA

[74] CHINAHONGKONG IP LIMITED

3011, 30/F, Office Tower, Convention Plaza, 1 Harbour Road

HONG KONG

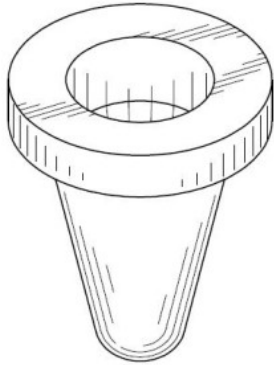

---

[11] 1913073.9

[15] 21-02-2019

[30] 10-09-2018 / CN / 201830507574.7

[51] Cl. 14-03

[54] 手機

Phone

[73] Blackshark Technologies(Nanchang) Co., Ltd.

Room 815-1, 8th Floor, Block A, Huajiang Building

No. 1 Tsinghua Science Park, No. 299, Yupingdong Street,

Nanchang Economic And Technological Development Zone, Nanchang

City, Jiangxi Province

CHINA

[74] CHINAHONGKONG IP LIMITED

3011, 30/F, Office Tower, Convention Plaza, 1 Harbour Road

HONG KONG



---

[11] 1913074.1

[15] 21-02-2019

[30] 12-10-2018 / CN / 201830571345.1

[51] Cl. 14-03

[54] 手機

Phone

[73] Blackshark Technologies(Nanchang) Co., Ltd.

Room 815-1, 8th Floor, Block A, Huajiang Building

No. 1 Tsinghua Science Park, No. 299, Yupingdong Street,

Nanchang Economic And Technological Development Zone, Nanchang

City, Jiangxi Province

CHINA

[74] CHINAHONGKONG IP LIMITED

3011, 30/F, Office Tower, Convention Plaza

1 Harbour Road

HONG KONG



[11] 1913077.8M001

[15] 22-02-2019

[51] Cl. 11-01

[54] 戒指

Ring

[73] Futago Jewelry Workshop Limited

FLAT 21, 16/F, ONE MIDTOWN

11 HOI SHING ROAD, TSUEN WAN

HONG KONG

[74] Tactics Intellectual Property Company Limited

Units 1205-08, Level 12, Cyberport 2,

No. 100 Cyberport Road,

HONG KONG



---

[11] 1913077.8M002

[15] 22-02-2019

[51] Cl. 11-01

[54] 戒指

Ring

[73] Futago Jewelry Workshop Limited

FLAT 21, 16/F, ONE MIDTOWN

11 HOI SHING ROAD, TSUEN WAN

HONG KONG

[74] Tactics Intellectual Property Company Limited

Units 1205-08, Level 12, Cyberport 2,

No. 100 Cyberport Road,

HONG KONG



---

[11] 1913077.8M003

[15] 22-02-2019

[51] Cl. 11-01

[54] 戒指

Ring

[73] Futago Jewelry Workshop Limited

FLAT 21, 16/F, ONE MIDTOWN

11 HOI SHING ROAD, TSUEN WAN

HONG KONG

[74] Tactics Intellectual Property Company Limited

Units 1205-08, Level 12, Cyberport 2,

No. 100 Cyberport Road,

HONG KONG



---

[11] 1913077.8M004

[15] 22-02-2019

[51] Cl. 11-01

[54] 戒指

Ring

[73] Futago Jewelry Workshop Limited  
FLAT 21, 16/F, ONE MIDTOWN  
11 HOI SHING ROAD, TSUEN WAN  
HONG KONG

[74] Tactics Intellectual Property Company Limited  
Units 1205-08, Level 12, Cyberport 2,  
No. 100 Cyberport Road,  
HONG KONG



---

[11] 1913077.8M005

[15] 22-02-2019

[51] Cl. 11-01

[54] 戒指

Ring

[73] Futago Jewelry Workshop Limited  
FLAT 21, 16/F, ONE MIDTOWN  
11 HOI SHING ROAD, TSUEN WAN  
HONG KONG

[74] Tactics Intellectual Property Company Limited  
Units 1205-08, Level 12, Cyberport 2,  
No. 100 Cyberport Road,  
HONG KONG



---

[11] 1913077.8M006



[15] 22-02-2019

[51] Cl. 11-01

[54] 戒指

Ring

[73] Futago Jewelry Workshop Limited

FLAT 21, 16/F, ONE MIDTOWN

11 HOI SHING ROAD, TSUEN WAN

HONG KONG

[74] Tactics Intellectual Property Company Limited

Units 1205-08, Level 12, Cyberport 2,

No. 100 Cyberport Road,

HONG KONG



---

[11] 1913077.8M007

[15] 22-02-2019

[51] Cl. 11-01

[54] 戒指

Ring

[73] Futago Jewelry Workshop Limited

FLAT 21, 16/F, ONE MIDTOWN

11 HOI SHING ROAD, TSUEN WAN

HONG KONG

[74] Tactics Intellectual Property Company Limited

Units 1205-08, Level 12, Cyberport 2,

No. 100 Cyberport Road,

HONG KONG





香港特別行政區政府知識產權署外觀設計註冊處

The Government of the Hong Kong Special Administrative Region

Designs Registry, Intellectual Property Department

根據註冊外觀設計條例第28條，下列註冊外觀設計因未繳續期費而停止有效。各組記項按註冊外觀設計停止有效日期及註冊編號先後次序排列。

Registered designs ceased through non-payment of renewal fees under section 28 of the Registered Designs Ordinance. Entries are listed below under their expiry dates.

## 29-05-2019 - 05-06-2019

29-05-2019	0900902.2M003	1401055.3
1401012.2	1401005.8M002	1401056.5M001
1401013.4	1401027.4	1401056.5M002
1401014.6M001	1401028.6	1401060.3M003
1401014.6M002	1401034.8	1401063.9M001
1401019.7		1401063.9M002
1401021.1	<b>03-06-2019</b>	1401063.9M003

0411250.6 1401063.9M004

**30-05-2019**

	0900906.1	1401064.1
9910663.5M003	0900920.0M003	1401067.8

9910663.5M004

9910663.5M005

**31-05-2019**

	1401037.5	
	1401038.7	
0411205.2	1401039.9M001	
0900892.9	1401039.9M002	
1401025.0	1401041.3	
9910669.8	9910681.3	
9910670.0	9910682.5	
	9910683.7	

**01-06-2019**

0411213.8M003	<b>04-06-2019</b>	
0411225.4M001	0411264.5	
0411225.4M002	0900926.3M001	
0411229.2	0900926.3M002	
0411230.4	1401043.7	
0411231.6	1401046.4M003	
0411232.8	1401048.8	
0900895.6	1401049.0	
0900896.8M001	1401050.2	
0900896.8M002	1401053.8	
	1401054.0	

**02-06-2019**

0900902.2M001

**05-06-2019**



香港特別行政區政府知識產權署外觀設計註冊處

The Government of the Hong Kong Special Administrative Region

Designs Registry, Intellectual Property Department

**根據註冊外觀設計規則第31條刪除的註冊外觀設計。各組記項按註冊外觀設計 刪除日期及註冊編號先後次序排列。**

**Registered designs removed under section 31 of the Registered Designs Rules. Entries are listed below under their removal dates.**

**07-06-2019 - 13-06-2019**

<b>07-06-2019</b>	0802862.7	0312124.9M002
0312073.0	1302143.9	0312124.9M003
0802837.5M001	1302145.4	0312124.9M004
0802837.5M002	1302146.6	0312124.9M005
0802837.5M003		0312124.9M006
0802837.5M004	<b>11-06-2019</b>	0312124.9M007
0802837.5M005	0312111.2	1302169.4
0802837.5M006	0312114.8M002	
0802837.5M007	1302147.8M001	
0802837.5M008	1302147.8M002	
0802837.5M010	1302148.0M001	
0802837.5M011	1302148.0M002	
0802837.5M012	1302151.6M001	
0802837.5M013	1302151.6M002	
0802837.5M014	1302154.2M001	
0802837.5M015	1302154.2M002	
0802837.5M018	1302154.2M003	
0802837.5M019		
0802837.5M020	<b>12-06-2019</b>	
0802837.5M021	0312123.7M001	
0802837.5M022	0312123.7M002	
0802837.5M023	0802896.9M001	
0802837.5M024	0802896.9M002	
0802837.5M025	1302159.3M001	
0802840.1	1302159.3M002	
	1302162.9	
	1302165.6	
<b>09-06-2019</b>		
0802843.7M001	1302166.8M001	
0802843.7M002	1302166.8M002	
1302138.9	1302166.8M003	
1302139.1	1302166.8M004	
1302141.5		
	<b>13-06-2019</b>	
<b>10-06-2019</b>	0312124.9M001	



香港特別行政區政府知識產權署外觀設計註冊處

The Government of the Hong Kong Special Administrative Region

Designs Registry, Intellectual Property Department

**根據註冊外觀設計條例第 67 及 76 條, 更正註冊紀錄冊內及已提交文件中的錯誤**

**Correction of errors in register and in filed documents under sections 67 and 76 of the Registered Designs Ordinance**

下列在 22.03.2019 官方公報刊登的更正錯誤的請求已在 23.05.2019 獲准許

The following request for correction of error advertised in the official journal on 22.03.2019 was allowed on 23.05.2019

[11] 1600002.2M003

[55] Representation(s) of the Design