

# 香港知識產權公報

Hong Kong Intellectual Property Journal

2020年8月28日

28 August 2020



## 目錄 Contents

### 根據註冊外觀設計條例第 25 條註冊的外觀設計

#### **Designs Registered under section 25 of the Registered Designs Ordinance**

按註冊編號排列

Arranged by Registration Number

### 根據註冊外觀設計條例(第 522 章)公布的其他公告

#### **Other Notices Published under the Registered Designs Ordinance (Cap. 522)**

根據註冊外觀設計條例第 28 條, 註冊外觀設計因未繳續期費而停止有效

Registered designs ceased through non-payment of renewal fees under section 28 of the Registered Designs Ordinance

根據註冊外觀設計規則第 31 條刪除的註冊外觀設計

Registered designs removed under section 31 of the Registered Designs Rules

### 以下事項沒有記錄

#### **No Records for the Following Matters**

根據註冊外觀設計條例第 30 條放棄的外觀設計的註冊

Surrender of Registration of Design under section 30 of the Registered Designs Ordinance

根據註冊外觀設計規則第 37 條, 向處長作出轉介

Reference to Registrar under section 37 of the Registered Designs Rules

根據註冊外觀設計條例第 45 條, 撤銷註冊

Revocation of Registration under section 45 of the Registered Designs Ordinance

根據註冊外觀設計規則第 46 條，向法院作出轉介

Reference to Court under section 46 of the Registered Designs Rules

根據註冊外觀設計規則第 63 條對不符合規定之處作出糾正

Rectification of Irregularities under section 63 of the Registered Designs Rules

根據註冊外觀設計條例第 66 條，糾正註冊紀錄冊

Rectification of Register under section 66 of the Registered Designs Ordinance

根據註冊外觀設計條例第 67 條 更正註冊紀錄冊內的錯誤

Correction of errors in Register under section 67 of the Registered Designs Ordinance

根據註冊外觀設計條例第 67 及 76 條，更正註冊紀錄冊內及已提交文件中的錯誤

Correction of Errors in Register and in Filed Documents under sections 67 and 76 of the Registered Designs Ordinance

根據註冊外觀設計條例第 76 條，更正已提交文件中的錯誤

Correction of errors in filed documents under section 76 of the Registered Designs Ordinance

勘誤

Corrigendum

## 註冊外觀設計公告註釋

### Notes on advertisements of registration of designs

方括號表示下列資料：

Square brackets indicate the following data：

[11] 註冊編號 Registration number / 聯合王國註冊編號 United Kingdom registration number

[15] 註冊日期 Registration date / 當作註冊日期 Deemed registration date / 聯合王國註冊日期 United Kingdom registration date

[17] 註冊有效期屆滿日期 Expiry date of the period of registration

[22] 提交日期 Filing date / 當作提交日期 Deemed filing date / 聯合王國提交日期 United Kingdom filing date

[30] 聲稱享有的優先權（提交日期 / 巴黎公約國或世界貿易組織成員 / 申請編號） Priority claimed (filing date / Paris Convention country or WTO member / application number)

[51] 國際外觀設計分類號（洛迦諾分類號） International Classification of designs (Locarno Classification)

[54] 物品 Article

[55] 外觀設計的表述 Representation of the design

[62] 分開前的申請編號及提交日期 Application number before division and filing date

[66] 過往註冊的聯繫外觀設計註冊編號 / 日期 Registration No. / Date of Previous Registration for Association

[72] 設計人 Designer

[73] 擁有人姓名和地址 Name and address of the owner

[74] 代理人 Agent / 送達地址 Address for service



香港特別行政區政府知識產權署外觀設計註冊處  
The Government of the Hong Kong Special Administrative Region  
Designs Registry, Intellectual Property Department

## 根據註冊外觀設計條例第 25 條註冊的外觀設計

### Designs registered under section 25 of the Registered Designs Ordinance

按註冊編號排列

Arranged by Registration Number

[11] 1913573.0

[15] 02-05-2019

[51] Cl. 20-02

Cl. 20-03

[54] 用於廣告宣傳和展示的吉祥物

Mascot for promotion and advertisement

[73] 推廣易有限公司

EZ Promo Limited

香港九龍

觀塘敬業街

利維大廈 1 樓 102C 室

[74] 推廣易有限公司

香港九龍

觀塘敬業街

利維大廈 1 樓 102C 室



---

[11] 2015637.2

[15] 20-02-2020

[30] 21-08-2019 / CN / 201930455005.7

[51] Cl. 14-02

[54] 臉容識別支付設備

Facial recognition payment device

[73] Alibaba Group Holding Limited

Fourth Floor, One Capital Place, P.O. Box 847, George Town,

Grand Cayman,

CAYMAN ISLANDS

[74] SPRUSON & FERGUSON (HONG KONG) LIMITED

5001 Hopewell Centre

183 Queen's Road East,

Wan Chai, Hong Kong

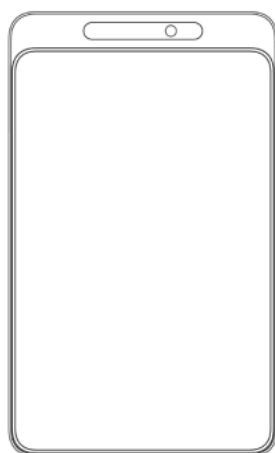

---

[11] 2015664.8M001

[15] 26-02-2020

[51] Cl. 3-01

[54] 行李箱支持物

Supporting device of the luggage

[73] 高新科技園有限公司

香港九龍長沙灣

元州街 265 號

昌發工廠大廈 2 樓 A 室

[74] 高新科技園有限公司

香港九龍長沙灣

元州街 265 號

昌發工廠大廈 2 樓 A 室



---

[11] 2015664.8M002

[15] 26-02-2020

[51] Cl. 3-99

[54] 行李箱輪子  
Wheel of the luggage

[73] 高新科技園有限公司  
香港九龍長沙灣  
元州街 265 號  
昌發工廠大廈 2 樓 A 室

[74] 高新科技園有限公司  
香港九龍長沙灣  
元州街 265 號  
昌發工廠大廈 2 樓 A 室



---

[11] 2015664.8M003

[15] 26-02-2020

[51] Cl. 3-01



[54] 行李箱

Luggage

[73] 高新科技園有限公司

香港九龍長沙灣

元州街 265 號

昌發工廠大廈 2 樓 A 室

[74] 高新科技園有限公司

香港九龍長沙灣

元州街 265 號

昌發工廠大廈 2 樓 A 室



---

[11] 2015900.0M001

[15] 01-04-2020

[30] 08-11-2019 / CN / 201930613470.9

[51] Cl. 6-01

[54] 沙發套件

Sofa set

[73] 莫安琪

中國內地

廣東省中山市南區永安三路 31 號

上苑花園 4 幢 606 房

[74] 百睿知識產權有限公司

香港新界

沙田香港科學園

科技大道西 10 號浚湖樓 617 室



---

[11] 2015900.0M002

[15] 01-04-2020

[30] 08-11-2019 / CN / 201930613595.1

[51] Cl. 6-01

[54] 沙發套件

Sofa set

[73] 莫安琪

中國內地

廣東省中山市南區永安三路 31 號

上苑花園 4 幢 606 房

[74] 百睿知識產權有限公司

香港新界

沙田香港科學園

科技大道西 10 號浚湖樓 617 室



- [11] 2015933.9  
[15] 08-04-2020  
[51] Cl. 23-04  
[54] 香薰器  
Aroma pod  
[73] 帝紀亞洲有限公司  
DK-ASIA.COM LIMITED  
香港  
上環新街市街 19 號  
地下  
[74] CTR PRODUCT DEVELOPMENT LIMITED  
香港九龍  
九龍灣宏光道 8 號  
創豪坊 7 樓 706 室

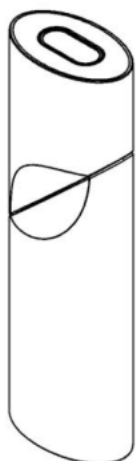

- 
- [11] 2015939.2  
[15] 08-04-2020  
[30] 09-10-2019 / EU / 007002134-0003  
[51] Cl. 8-04  
[54] 充電式鑽孔螺絲刀  
Battery drilling screwdriver  
[73] Würth International AG  
Aspermontstrasse 1,  
7000 Chur,  
SWITZERLAND  
[74] TRADEMARKCN COMPANY LIMITED  
Block A, 4/F., Granville Building,  
14 Granville Road,  
Tsim Sha Tsui, Kowloon,  
Hong Kong



---

[11] 2015945.5

[15] 08-04-2020

[30] 09-10-2019 / EU / 007002134-0009

[51] Cl. 8-01

[54] 旋轉錘鑽

Rotary hammer drill

[73] Würth International AG

Aspermontstrasse 1,

7000 Chur,

SWITZERLAND

[74] TRADEMARKCN COMPANY LIMITED

Block A, 4/F., Granville Building,

14 Granville Road,

Tsim Sha Tsui, Kowloon,

Hong Kong



---

[11] 2015954.3

[15] 09-04-2020

[51] Cl. 8-08

- [54] 防拆螺絲加強配件  
Stiffener of tamper-proof screw
- [73] 古永善  
KOO WING SIN RICKY  
Flat J, 18/F., Blk 2, Sunningdale Garden,  
No.8 Chi Cheong Road,  
Sheung Shui, New Territories, Hong Kong
- [74] K.Y. LO & CO., SOLICITORS  
UNIT 1709-10, 17/F., WING ON HOUSE,  
NO.71 DES VOEUX ROAD CENTRAL,  
HONG KONG

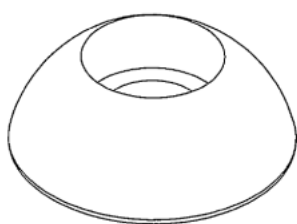

- 
- [11] 2015966.9
- [15] 10-04-2020
- [51] Cl. 2-02
- [54] T 恤  
T-shirt
- [73] 廣州瑞查進出口服務有限公司  
中國內地  
廣州市天河區  
珠江西路 8 號 1501 房自編 1517
- [74] 滙誠知識產權有限公司  
香港灣仔  
軒尼詩道 397 號  
東區商業大廈 1206 室



- 
- [11] 2015969.5  
[15] 14-04-2020  
[51] Cl. 23-04  
[54] 通風系統  
Ventilation system  
[73] Sino Innovation Laboratory Limited  
11-12/F Tsim Sha Tsui Centre,  
Salisbury Road,  
Tsim Sha Tsui, Kowloon, Hong Kong  
[74] DEACONS  
5th Floor, Alexandra House,  
Central,  
Hong Kong

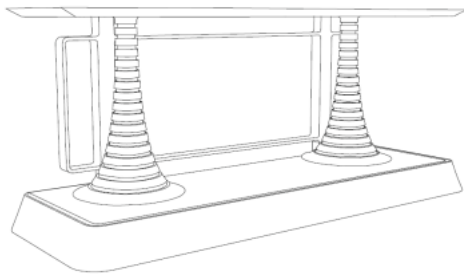

- 
- [11] 2015971.9  
[15] 14-04-2020  
[30] 18-11-2019 / JP / 025506 of 2019  
[51] Cl. 26-05  
[54] 舞台用照明器具  
Stage lighting apparatus  
[73] ISA 股份有限公司  
ISA CO., LTD.  
1493-1, Kozukuecho, Kohoku-ku,

Yokohama-shi,  
Kanagawa, 2220036,  
JAPAN

- [74] BARRON & YOUNG INTELLECTUAL PROPERTY LIMITED  
Suite 617, Lakeside 2,  
No. 10 Science Park West Avenue,  
Hong Kong Science Park,  
Shatin, N.T., Hong Kong

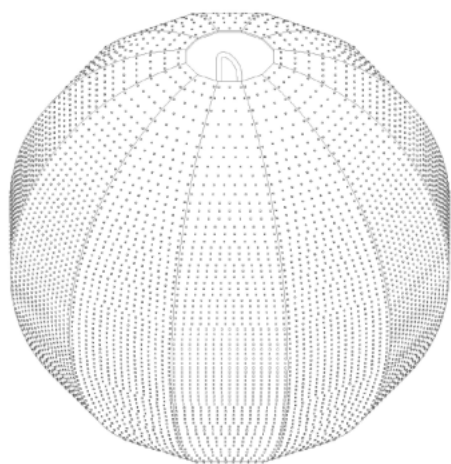

- 
- [11] 2015998.6  
[15] 16-04-2020  
[51] Cl. 23-04  
[54] 空氣淨化機  
Air purifier  
[73] 尤枝偉  
YAU, Chi Wai Jeffery  
香港九龍  
荔枝角永康街  
永康中心 16 樓 D 室  
[74] 旻貝國際知識產權代理有限公司  
香港新界  
白石角香港科學園  
第三期科技大道西 12 號 2 樓 230 室

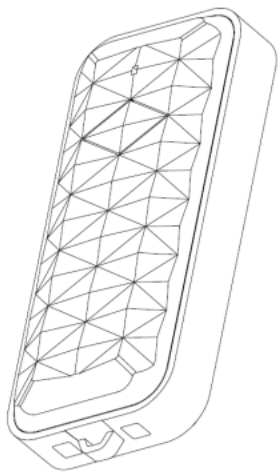

---

[11] 2016020.4M001

[15] 21-04-2020

[30] 04-03-2020 / IB / WIPO92525

[51] Cl. 10-07

[54] 錶面

Watch dial

[73] RICHEMONT INTERNATIONAL SA

Route des Biches 10,  
1752 Villars-sur-Glâne,  
SWITZERLAND

[74] MINTERELLISON LLP

Level 32, Wu Chung House,  
213 Queen's Road East,  
Hong Kong

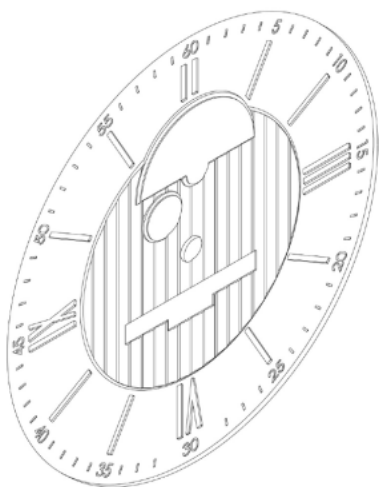



- [11] 2016020.4M002
- [15] 21-04-2020
- [30] 04-03-2020 / IB / WIPO92525
- [51] Cl. 10-07
- [54] 錶面  
Watch dial
- [73] RICHEMONT INTERNATIONAL SA  
Route des Biches 10,  
1752 Villars-sur-Glâne,  
SWITZERLAND
- [74] MINTERELLISON LLP  
Level 32, Wu Chung House,  
213 Queen's Road East,  
Hong Kong

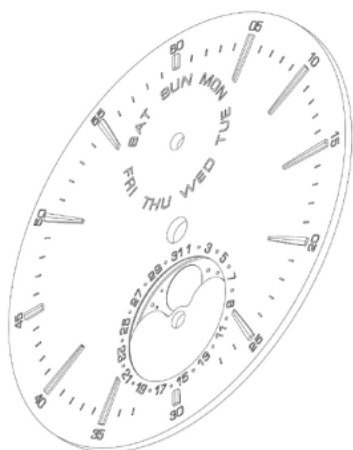

- 
- [11] 2016020.4M003
  - [15] 21-04-2020
  - [30] 04-03-2020 / IB / WIPO92525
  - [51] Cl. 10-07
  - [54] 錶面  
Watch dial
  - [73] RICHEMONT INTERNATIONAL SA  
Route des Biches 10,  
1752 Villars-sur-Glâne,  
SWITZERLAND
  - [74] MINTERELLISON LLP  
Level 32, Wu Chung House,  
213 Queen's Road East,  
Hong Kong



---

[11] 2016020.4M004

[15] 21-04-2020

[30] 04-03-2020 / IB / WIPO92525

[51] Cl. 10-07

[54] 錶面

Watch dial

[73] RICHEMONT INTERNATIONAL SA

Route des Biches 10,  
1752 Villars-sur-Glâne,  
SWITZERLAND

[74] MINTERELLISON LLP

Level 32, Wu Chung House,  
213 Queen's Road East,  
Hong Kong

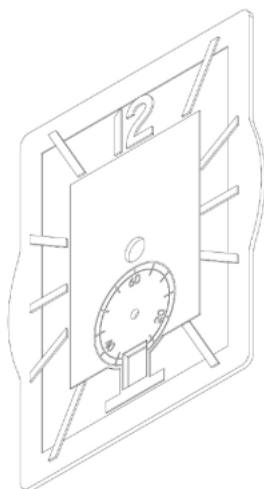

- [11] 2016020.4M005  
[15] 21-04-2020  
[30] 04-03-2020 / IB / WIPO92525  
[51] Cl. 10-07  
[54] 錶面  
Watch dial  
[73] RICHEMONT INTERNATIONAL SA  
Route des Biches 10,  
1752 Villars-sur-Glâne,  
SWITZERLAND  
[74] MINTERELLISON LLP  
Level 32, Wu Chung House,  
213 Queen's Road East,  
Hong Kong

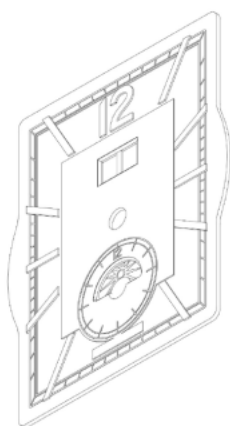

- 
- [11] 2016020.4M006  
[15] 21-04-2020  
[30] 04-03-2020 / IB / WIPO92525  
[51] Cl. 10-07  
[54] 錶面  
Watch dial  
[73] RICHEMONT INTERNATIONAL SA  
Route des Biches 10,  
1752 Villars-sur-Glâne,  
SWITZERLAND  
[74] MINTERELLISON LLP  
Level 32, Wu Chung House,  
213 Queen's Road East,  
Hong Kong

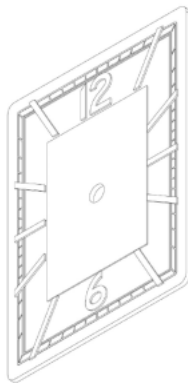

---

[11] 2016020.4M007

[15] 21-04-2020

[30] 04-03-2020 / IB / WIPO92525

[51] Cl. 10-07

[54] 錶面

Watch dial

[73] RICHEMONT INTERNATIONAL SA

Route des Biches 10,  
1752 Villars-sur-Glâne,  
SWITZERLAND

[74] MINTERELLISON LLP

Level 32, Wu Chung House,  
213 Queen's Road East,  
Hong Kong

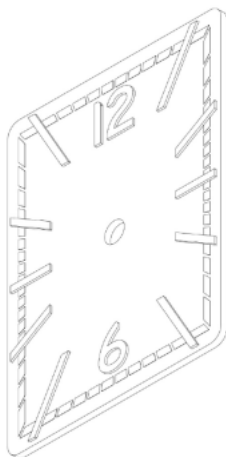

---

[11] 2016020.4M008

[15] 21-04-2020

[30] 04-03-2020 / IB / WIPO92525

[51] Cl. 10-07

[54] 錶面

Watch dial

[73] RICHEMONT INTERNATIONAL SA

Route des Biches 10,  
1752 Villars-sur-Glâne,  
SWITZERLAND

[74] MINTERELLISON LLP

Level 32, Wu Chung House,  
213 Queen's Road East,  
Hong Kong

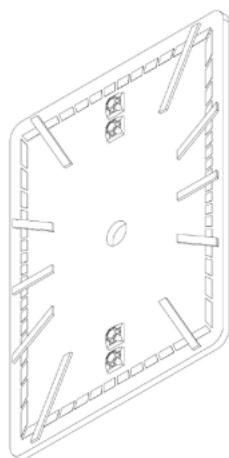

[11] 2016032.9

[15] 22-04-2020

[30] 22-10-2019 / AU / 201916036

[51] Cl. 12-03

[54] 鐵軌轉向架的板簧

Leaf springs of the railway bogie

[73] 福迪諾私人有限公司

Fordyno Pty Ltd

澳大利亞

新南威爾士州聖倫納茲克里

斯蒂大街 118 號 301 室

[74] IPWELL INTERNATIONAL INTELLECTUAL PROPERTY COMPANY LIMITED

香港九龍

尖沙咀廣東道 5 號

海港城海洋中心 8 樓 826 室

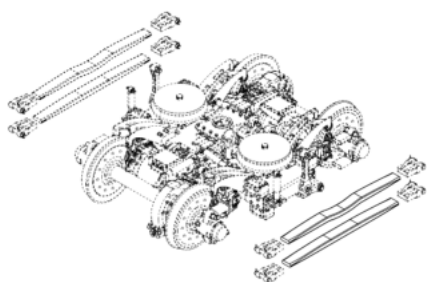

---

[11] 2016036.8

[15] 22-04-2020

[51] Cl. 3-01

[54] 信封形套

Envelope shaped holder

[73] 世攜有限公司

ZETO LIMITED

Rm E, 10/F, Full Win Comm Ctr,

573 Nathan Rd,

Mongkok, Kowloon, Hong Kong

[74] REG EASY INTELLECTUAL PROPERTY CO., LIMITED

14/F, China Hong Kong Tower,

8 Hennessy Road,

Wan Chai, Hong Kong



---

[11] 2016042.0M001

[15] 23-04-2020

[30] 20-12-2019 / US / 29/718,138

[51] Cl. 9-03

[54] 食品容器  
Food container

[73] 祖美股份有限公司  
ZUME, Inc.  
250 Polaris Avenue Mountain View,  
California 94043,  
United States

[74] CHINAHONGKONG IP LIMITED  
3011, 30/F, Office Tower, Convention Plaza,  
1 Harbour Road,  
Hong Kong

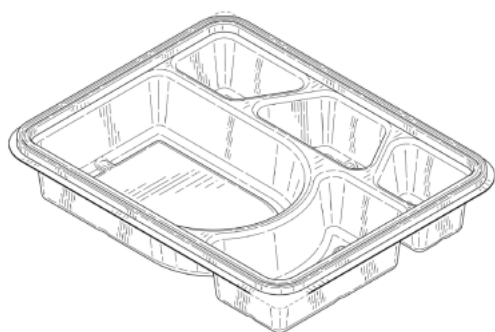

---

[11] 2016042.0M002

[15] 23-04-2020

[30] 20-12-2019 / US / 29/718,138

[51] Cl. 9-03

[54] 食品容器  
Food container

[73] 祖美股份有限公司  
ZUME, Inc.  
250 Polaris Avenue Mountain View,  
California 94043,  
United States

[74] CHINAHONGKONG IP LIMITED  
3011, 30/F, Office Tower, Convention Plaza,  
1 Harbour Road,  
Hong Kong

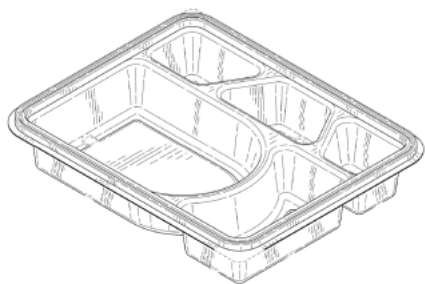

---

[11] 2016042.0M003

[15] 23-04-2020

[30] 20-12-2019 / US / 29/718,138

[51] Cl. 9-03

[54] 食品容器  
Food container

[73] 祖美股份有限公司  
ZUME, Inc.  
250 Polaris Avenue Mountain View,  
California 94043,  
United States

[74] CHINAHONGKONG IP LIMITED  
3011, 30/F, Office Tower, Convention Plaza,  
1 Harbour Road,  
Hong Kong

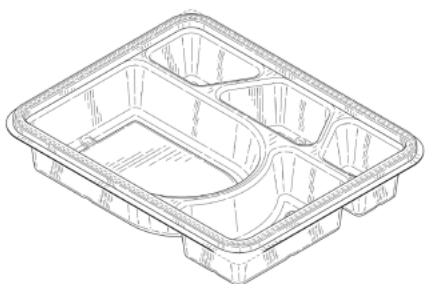

---

[11] 2016042.0M004

[15] 23-04-2020

[30] 20-12-2019 / US / 29/718,138

[51] Cl. 9-03

[54] 食品容器  
Food container

[73] 祖美股份有限公司  
ZUME, Inc.  
250 Polaris Avenue Mountain View,



California 94043,  
United States

- [74] CHINAHONGKONG IP LIMITED  
3011, 30/F, Office Tower, Convention Plaza,  
1 Harbour Road,  
Hong Kong

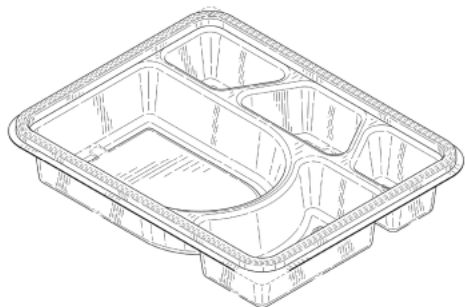

---

[11] 2016043.2

[15] 24-04-2020

[51] Cl. 7-02

[54] 透視、雙層真空咖啡濾杯、內層有特定旋渦紋

A transparent double layer vacuum coffee dripper with ripple spiral in the inner layer

[73] 柏澗有限公司

D Throwing Pebble Limited  
RM 1306, 13/F., ALLIANCE BUILDING,  
130 CONNAUGHT RD CENTRAL,  
HONG KONG

[74] Hsu Hung Yao

RM A, 13/F., ALLIANCE BUILDING,  
130-136 CONNAUGHT ROAD CENTRAL,  
HONG KONG



- [11] 2016055.8  
[15] 24-04-2020  
[51] Cl. 23-04  
[54] 隨身帶光電子空氣淨化器  
Portable optoelectronic air purifier  
[73] 中興科技集團有限公司  
John Technology Holdings Limited  
Flat B, 7/F, Everwin Centre,  
72 Hung To Road,  
Kwun Tong, Kowloon, Hong Kong

袁仕傑

YUEN SE KIT  
Flat B, 7/F, Everwin Centre,  
72 Hung To Road,  
Kwun Tong, Kowloon, Hong Kong

- [74] JOHN MANUFACTURING LIMITED  
Flat B, 7/F, Everwin Centre,  
72 Hung To Road,  
Kwun Tong, Kowloon, Hong Kong

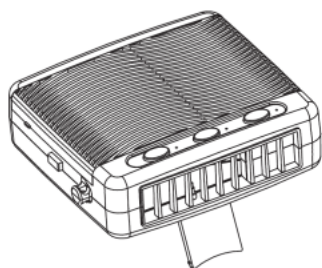

- 
- [11] 2016056.0  
[15] 24-04-2020  
[51] Cl. 21-01  
[54] 玩具巴士  
Toy bus  
[73] NEW WORLD FIRST BUS SERVICES LIMITED  
8 Chong Fu Road,  
Chai Wan, Hong Kong  
[74] IPMS CONSULTANTS LIMITED  
Unit 2004B, 20/F, Tower 5,  
China Hong Kong City,  
33 Canton Road, Tsim Sha Tsui, Kowloon,  
Hong Kong



---

[11] 2016058.4M001

[15] 24-04-2020

[51] Cl. 21-01

[54] 玩具獅子

Toy lion

[73] 譽鋒玩具有限公司

Fame Master International Limited  
Unit 541, 5/F., Sino Industrial Plaza,  
9 Kai Cheung Road,  
Kowloon Bay, Kowloon, Hong Kong

[74] HONG KONG INTELLECTUAL PROPERTY ADVISORY SERVICE LIMITED

Unit 1701, 17/F., Ew International Tower,  
120 Texaco Road, Tsuen Wan,  
New Territories, Hong Kong

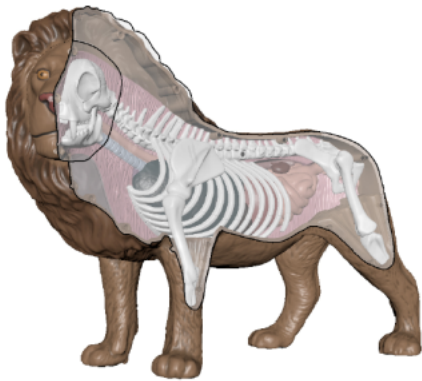

---

[11] 2016058.4M002

[15] 24-04-2020

[51] Cl. 21-01

[54] 玩具大象

Toy elephant

[73] 譽鋒玩具有限公司

Fame Master International Limited  
Unit 541, 5/F., Sino Industrial Plaza,  
9 Kai Cheung Road,  
Kowloon Bay, Kowloon, Hong Kong

[74] HONG KONG INTELLECTUAL PROPERTY ADVISORY SERVICE LIMITED

Unit 1701, 17/F., Ew International Tower,  
120 Texaco Road, Tsuen Wan,  
New Territories, Hong Kong

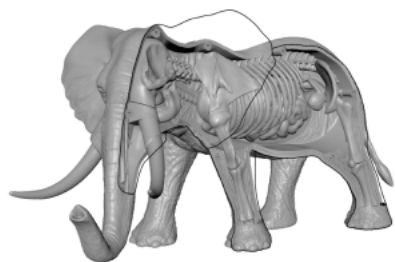

---

[11] 2016058.4M003

[15] 24-04-2020

[51] Cl. 21-01

[54] 玩具噬菌體模型

Toy bacteriophage model

[73] 譽鋒玩具有限公司

Fame Master International Limited  
Unit 541, 5/F., Sino Industrial Plaza,  
9 Kai Cheung Road,  
Kowloon Bay, Kowloon, Hong Kong

[74] HONG KONG INTELLECTUAL PROPERTY ADVISORY SERVICE LIMITED

Unit 1701, 17/F., Ew International Tower,  
120 Texaco Road, Tsuen Wan,  
New Territories, Hong Kong

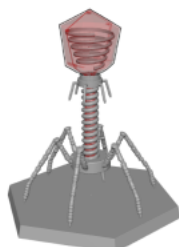

- [11] 2016066.1  
[15] 28-04-2020  
[51] Cl. 7-02  
[54] 用於鑊的圖案  
Pattern for wok  
[73] 陳鍾鴻  
CHAN CHUNG HUNG  
香港油塘  
高輝道 17 號  
油塘工業城 A2 座 13 樓 1313-16 室  
[74] 卓遠知識產權有限公司  
香港上環  
禧利街 27 號  
富輝商業中心 10 樓



- 
- [11] 2016073.5  
[15] 28-04-2020  
[30] 30-10-2019 / JP / 024174 of 2019  
[51] Cl. 9-01  
[54] 包裝用容器  
Packaging container  
[73] 株式會社 MTG  
MTG Co., Ltd.  
32, Honjin-Dori 2-Chome, Nakamura-Ku, Nagoya-Shi, Aichi-Ken  
453-0041,  
Japan  
[74] CHINAHONGKONG IP LIMITED  
3011, 30/F, Office Tower, Convention Plaza,  
1 Harbour Road,  
Hong Kong

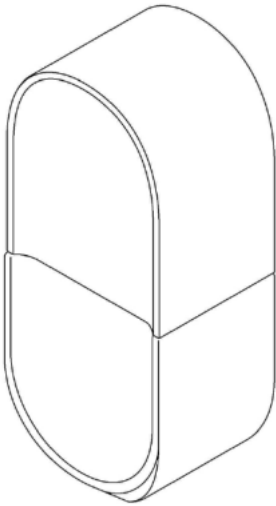

[11] 2016077.4

[15] 29-04-2020

[51] Cl. 11-03

[54] 獎座  
Medal

[73] 國鑫獎品及禮品有限公司  
KK TROPHY & GIFTS COMPANY LIMITED  
Flat D, 16/F, Block 7, Richland Gardens,  
80 Wang Kwong Rd,  
Kowloon Bay, Hong Kong

[74] CONPAK INTELLECTUAL PROPERTY LIMITED  
Rooms 05-15, 13A/F, South Tower,  
World Finance Centre, Harbour City,  
17 Canton Road,  
Tsim Sha Tsui, Kowloon, Hong Kong



- 
- [11] 2016079.8  
[15] 29-04-2020  
[51] Cl. 9-03  
[54] 包裝紙盒子  
Packaging cardboard box  
[73] 天譽新科技有限公司  
JBC New Technology Co. Limited  
Flat D, 19/F., V Ga Building,  
532 Castle Peak Road,  
Cheung Sha Wan, Kowloon, Hong Kong  
[74] Wong & Tang Solicitors  
2001-2, 2012 & 2310, 20 & 23/F, CC Wu Bldg,  
Nos. 302-308 Hennessy Road,  
Wan Chai, Hong Kong



- 
- [11] 2016091.3  
[15] 04-05-2020  
[30] 26-12-2019 / CH / DM/205 838  
[51] Cl. 10-07  
[54] 擺錘  
Oscillating weight  
[73] LVMH SWISS MANUFACTURES SA  
Rue Louis-Joseph Chevrolet 6A,  
2300 La Chaux-de-Fonds,  
Switzerland  
[74] WENPING PATENT & TRADE MARK AGENT LIMITED  
1701 Tung Wai Commercial Building,  
111 Gloucester Road,  
Hong Kong

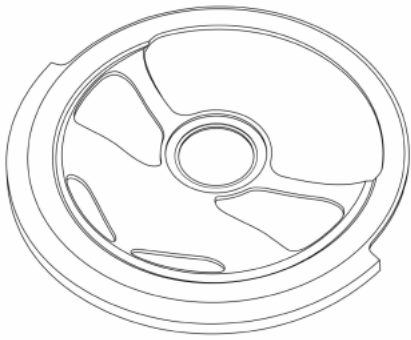

---

[11] 2016098.8M001

[15] 05-05-2020

[51] Cl. 7-01

[54] 圓形碗  
Round bowl

[73] 惠州市冠展實業有限公司  
中國內地  
廣東省惠州市仲愷高新區惠環街道  
西坑工業區 38 號 1、2 號廠房

[74] 卓遠知識產權有限公司  
香港上環  
禧利街 27 號  
富輝商業中心 10 樓

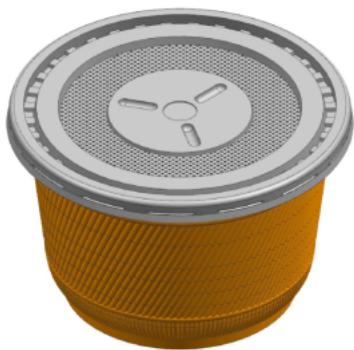

---

[11] 2016098.8M002

[15] 05-05-2020

[51] Cl. 7-01

[54] 分體三格餐盒  
Split lunch box with 3 compartments



[73] 惠州市冠展實業有限公司  
中國內地  
廣東省惠州市仲愷高新區惠環街道  
西坑工業區 38 號 1、2 號廠房

[74] 卓遠知識產權有限公司  
香港上環  
禧利街 27 號  
富輝商業中心 10 樓

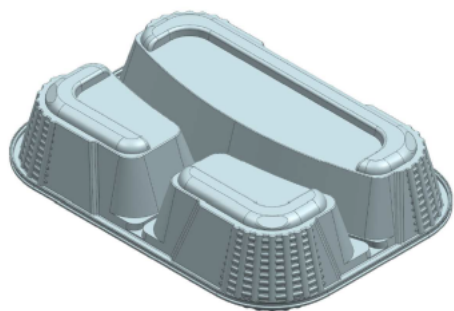

---

[11] 2016098.8M003

[15] 05-05-2020

[51] Cl. 7-01

[54] 分體兩格餐盒  
Split lunch box with 2 compartments

[73] 惠州市冠展實業有限公司  
中國內地  
廣東省惠州市仲愷高新區惠環街道  
西坑工業區 38 號 1、2 號廠房

[74] 卓遠知識產權有限公司  
香港上環  
禧利街 27 號  
富輝商業中心 10 樓

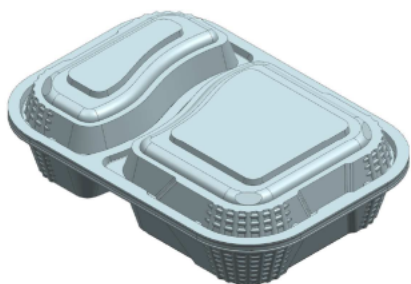

- [11] 2016098.8M004  
[15] 05-05-2020  
[51] Cl. 7-01  
[54] 分體單格餐盒  
Split lunch box with 1 compartment  
[73] 惠州市冠展實業有限公司  
中國內地  
廣東省惠州市仲愷高新區惠環街道  
西坑工業區 38 號 1、2 號廠房  
[74] 卓遠知識產權有限公司  
香港上環  
禧利街 27 號  
富輝商業中心 10 樓

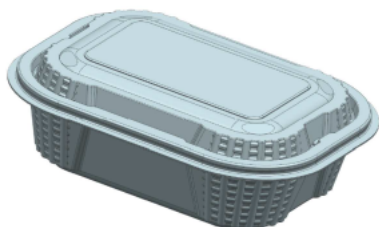

- 
- [11] 2016098.8M005  
[15] 05-05-2020  
[51] Cl. 7-01  
[54] 連體三格餐盒  
Conjoined lunch box with 3 compartments  
[73] 惠州市冠展實業有限公司  
中國內地  
廣東省惠州市仲愷高新區惠環街道  
西坑工業區 38 號 1、2 號廠房  
[74] 卓遠知識產權有限公司  
香港上環  
禧利街 27 號  
富輝商業中心 10 樓



---

[11] 2016098.8M006

[15] 05-05-2020

[51] Cl. 7-01

[54] 連體兩格餐盒

Conjoined lunch box with 2 compartments

[73] 惠州市冠展實業有限公司

中國內地

廣東省惠州市仲愷高新區惠環街道

西坑工業區 38 號 1、2 號廠房

[74] 卓遠知識產權有限公司

香港上環

禧利街 27 號

富輝商業中心 10 樓



---

[11] 2016098.8M007

[15] 05-05-2020

[51] Cl. 7-01

[54] 連體單格餐盒

Conjoined lunch box with 1 compartment

[73] 惠州市冠展實業有限公司

中國內地

廣東省惠州市仲愷高新區惠環街道  
西坑工業區 38 號 1、2 號廠房

- [74] 卓遠知識產權有限公司  
香港上環  
禧利街 27 號  
富輝商業中心 10 樓

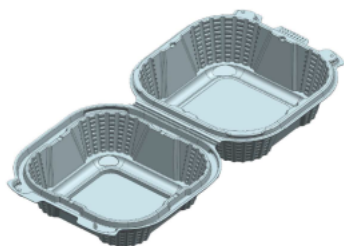

- 
- [11] 2016099.0  
[15] 06-05-2020  
[30] 29-01-2020 / CA, LI, MC, OM, RU, SG, CH, TR, UA, GB, VN, EU,  
IS, JP, KR / WIPO91577  
[51] Cl. 10-02  
[54] 手錶  
Watch  
[73] Turlen Holding SA  
Rue du Jura 11,  
2345 Les Breuleux,  
Switzerland  
[74] WILKINSON & GRIST  
6th Floor, Prince's Building,  
Chater Road,  
Hong Kong



---

[11] 2016100.4M001

[15] 06-05-2020

[30] 26-11-2019 / EU / 007297486

[51] Cl. 24-02

[54] 母乳泵

Breast pump

[73] Koninklijke Philips N.V.

High Tech Campus 52,

5656 AG Eindhoven,

Netherlands

[74] WILKINSON & GRIST

6th Floor, Prince's Building,

Chater Road,

Hong Kong

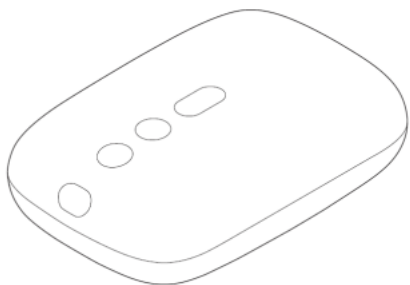

---

[11] 2016100.4M002

[15] 06-05-2020

[30] 26-11-2019 / EU / 007297486

[51] Cl. 24-02

[54] 母乳泵

Breast pump

[73] Koninklijke Philips N.V.

High Tech Campus 52,

5656 AG Eindhoven,

Netherlands

[74] WILKINSON & GRIST

6th Floor, Prince's Building,

Chater Road,

Hong Kong

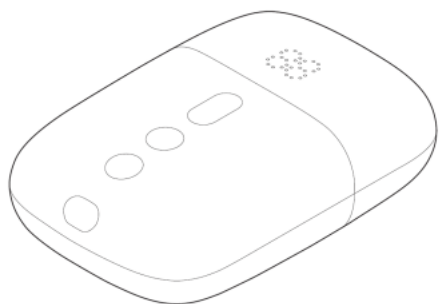

---

[11] 2016100.4M003

[15] 06-05-2020

[30] 26-11-2019 / EU / 007297486

[51] Cl. 24-02

[54] 母乳泵

Breast pump

[73] Koninklijke Philips N.V.

High Tech Campus 52,

5656 AG Eindhoven,

Netherlands

[74] WILKINSON & GRIST

6th Floor, Prince's Building,

Chater Road,

Hong Kong

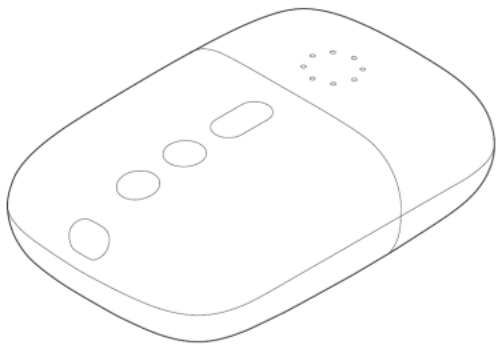

---

[11] 2016100.4M004

[15] 06-05-2020

[30] 26-11-2019 / EU / 007297486

[51] Cl. 24-02

[54] 母乳泵

Breast pump

[73] Koninklijke Philips N.V.

High Tech Campus 52,

5656 AG Eindhoven,

Netherlands

[74] WILKINSON & GRIST

6th Floor, Prince's Building,

Chater Road,

Hong Kong

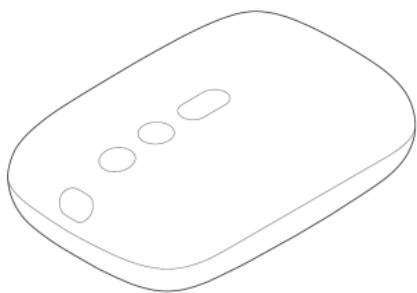

---

[11] 2016101.6

[15] 06-05-2020

[51] Cl. 9-03

[54] 急凍帶子包裝袋

Packaging bag of frozen scallop

[73] 利達海產貿易有限公司

Leader Marine Products Trading Ltd.

香港香港仔田灣  
海旁道 7 號  
興偉工業中心 6 樓 613B 室

[74] Leader Marine Products Trading Ltd.

香港香港仔田灣  
海旁道 7 號  
興偉工業中心 6 樓 613B 室



---

[11] 2016102.8

[15] 06-05-2020

[30] 30-01-2020 / NO, SG, CH, EU, JP, KR / DM/206 086

[51] Cl. 7-02

[54] 煮咖啡器  
Coffee maker

[73] Pi-Design AG  
Kantonsstrasse 100,  
CH-6234 Triengen,  
Switzerland

[74] WENPING PATENT & TRADE MARK AGENT LIMITED  
1701 Tung Wai Commercial Building,  
111 Gloucester Road,  
Hong Kong



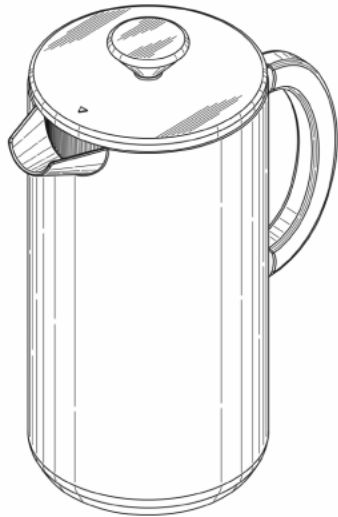

---

[11] 2016103.0

[15] 06-05-2020

[30] 30-12-2019 / CN / 201930744177.6

[51] Cl. 6-09

[54] 糾正枕

Correction pillow

[73] 深圳市翹翹抗衰老生物科技有限公司

Shenzhen Qiaoqiao Anti-aging Biotechnology Co., Ltd.

中國內地

深圳市羅湖區南湖街道人民南路

佳寧娜廣場 A 座 1403

[74] 旻貝國際知識產權代理有限公司

香港新界

白石角香港科學園

第三期科技大道西 12 號 2 樓 230 室



- [11] 2016104.2  
[15] 06-05-2020  
[30] 22-11-2019 / CN / 201930647604.9  
[51] Cl. 15-99  
[54] 船身爬行機器人  
Hull crawling robot  
[73] 納百創新科技有限公司  
Neptune Robotics Limited  
香港上環  
文咸東街 135 號  
文咸東街 135 商業中心 14 樓 1405 室  
[74] 中港專利有限公司  
香港  
港灣道 1 號會展廣場  
辦公大樓 30 樓 3012 室

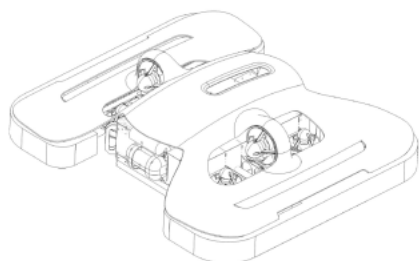

- 
- [11] 2016105.5  
[15] 06-05-2020  
[51] Cl. 29-02  
[54] 全棉口罩套  
Cotton mask cover  
[73] 沙永林  
Sha Wing Lam  
Flat C, 33/F., Tower 5, The Beaumont,  
8 Shek Kok Rd.,  
Tseung Kwan O, N.T. Hong Kong  
[74] ACCOLADE IP LIMITED  
10/F, Fu Fai Comm. Ctr.,  
27 Hillier Street,  
Sheung Wan, Hong Kong

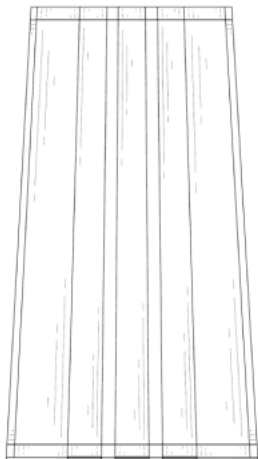

---

[11] 2016106.7

[15] 07-05-2020

[51] Cl. 7-02

[54] 奶泡機

Milk frother

[73] TUNBOW GROUP LIMITED

10/F, Block A, Chung Mei Centre,  
No.15 Hing Yip Street,  
Kwun Tong, Hong Kong

[74] MR SIMON LEE

10/F, Block A, Chung Mei Centre,  
15 Hing Yip Street,  
Kwun Tong, Hong Kong



- [11] 2016111.7M001  
[15] 07-05-2020  
[30] 07-11-2019 / EU / 007199674  
[51] Cl. 3-01  
[54] 袋  
Bag  
[73] FURLA S.p.A.  
Via Bellaria 3-5,  
I-40068 S. Lazzaro di Savena (Bologna),  
Italy  
[74] Bird & Bird  
6/F, The Annex, Central Plaza  
18 Harbour Road  
Hong Kong



- 
- [11] 2016111.7M002  
[15] 07-05-2020  
[30] 07-11-2019 / EU / 007199674  
[51] Cl. 3-01  
[54] 袋  
Bag  
[73] FURLA S.p.A.  
Via Bellaria 3-5,  
I-40068 S. Lazzaro di Savena (Bologna),  
Italy  
[74] Bird & Bird  
6/F, The Annex, Central Plaza  
18 Harbour Road  
Hong Kong



---

[11] 2016112.9

[15] 07-05-2020

[51] Cl. 24-01

[54] 可摺疊紫外線 C 消毒盒  
Foldable UV-C sterilizing box

[73] 瑞士歐斯科控股有限公司  
Travelmall Switzerland Holdings Limited  
Flat C, 2/F, Kin Ga Industrial Building,  
9 San On Street,  
Tuen Mun, Hong Kong

[74] LEUNG KIN & CO  
9/F Hang Seng Yuen Long Building,  
91-93 Castle Peak Road,  
Yuen Long, Hong Kong

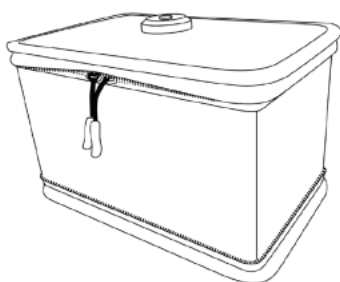

---

[11] 2016113.1

[15] 07-05-2020

[30] 31-03-2020 / CA, NO, RU, SG, CH, US, EU, JP / WIPO93570

[51] Cl. 20-02

[54] 手錶支架  
Watch stand

[73] The Watch Stand Global AG  
Östermalmsgatan 67,114 50 Stockholm,  
Sweden

[74] WILKINSON & GRIST  
6th Floor, Prince's Building,  
Chater Road,  
Hong Kong

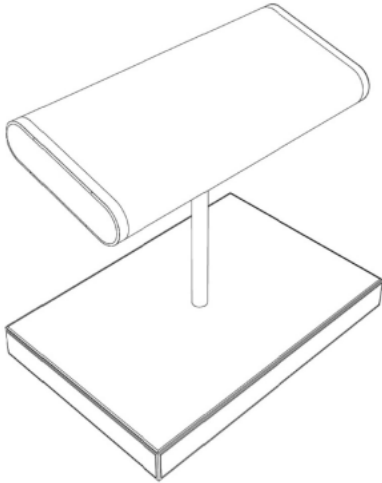

---

[11] 2016114.3

[15] 08-05-2020

[51] Cl. 7-01

[54] 餐具  
Tableware

[73] 株式會社利其爾  
RICHELL CORPORATION  
136 Mizuhashi sakuragi,  
Toyama-shi, Toyama, 939-0592,  
Japan

[74] CHINA PATENT AGENT (HONG KONG) LIMITED  
22/F, Great Eagle Centre,  
23 Harbour Road,  
Wanchai, Hong Kong

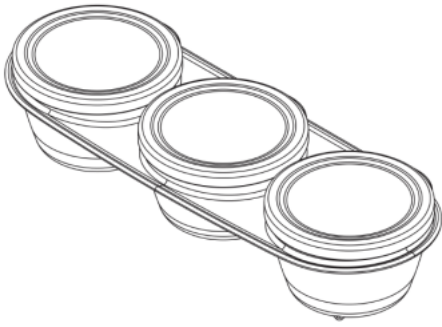

---

[11] 2016115.6

[15] 08-05-2020

[51] Cl. 7-01

[54] 餐具  
Tableware

[73] 株式會社利其爾  
RICHELL CORPORATION  
136 Mizuhashi sakuragi, Toyama-shi,  
Toyama, 939-0592,  
Japan

[74] 中國專利代理(香港)有限公司  
香港灣仔  
港灣道 23 號  
鷹君中心 22 字樓



---

[11] 2016116.8

[15] 08-05-2020

[51] Cl. 23-04

[54] 空氣淨化器  
Air purifier

[73] 盛開蓮花有限公司  
Bloomy Lotus Ltd  
Unit 4711, 47/F., The Center,

99 Queen's Road Central,  
Central, Hong Kong

- [74] FEDERATION OF HONG KONG INDUSTRIES  
31/F, Billion Plaza,  
8 Cheung Yue Street,  
Cheung Sha Wan, Kowloon,  
Hong Kong

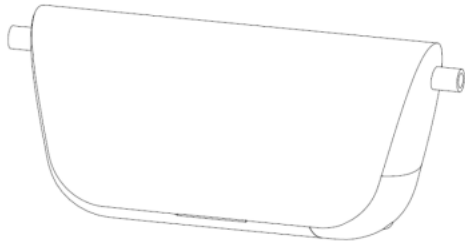

---

[11] 2016117.0

[15] 08-05-2020

[51] Cl. 23-04

[54] 空氣淨化器  
Air purifier

[73] 盛開蓮花有限公司  
Bloomy Lotus Ltd  
Unit 4711, 47/F., The Center,  
99 Queen's Road Central, Central,  
Hong Kong

[74] FEDERATION OF HONG KONG INDUSTRIES  
31/F, Billion Plaza,  
8 Cheung Yue Street, Cheung Sha Wan,  
Kowloon, Hong Kong





- [11] 2016118.2  
[15] 08-05-2020  
[30] 08-11-2019 / EU / 007207766  
[51] C1. 21-01  
[54] 玩具車  
Toy car  
[73] FERRARI S.p.A.  
Via Emilia Est 1163,  
I-41100 Modena,  
Italy  
[74] CHINA PATENT AGENT (HONG KONG) LIMITED  
22/F, Great Eagle Centre,  
23 Harbour Road,  
Wanchai, Hong Kong

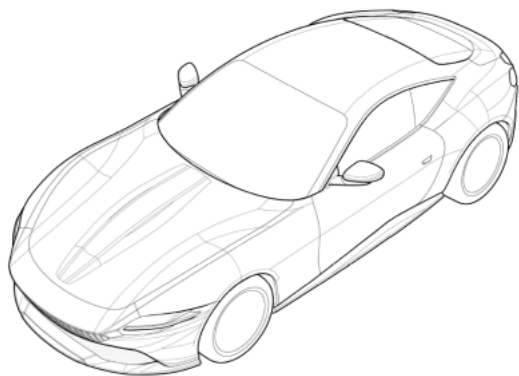

- 
- [11] 2016119.4M001  
[15] 08-05-2020  
[30] 11-12-2019 / EU / 007383674-0001  
[51] C1. 15-05  
[54] 吸塵器  
Vacuum cleaner  
[73] Dyson Technology Limited  
Tetbury Hill, Malmesbury,  
Wiltshire, SN16 0RP,  
United Kingdom  
[74] LIU, SHEN & ASSOCIATES  
Room 3716, 37/F, Sun Hung Kai Centre,  
30 Harbour Road,  
Wanchai, Hong Kong

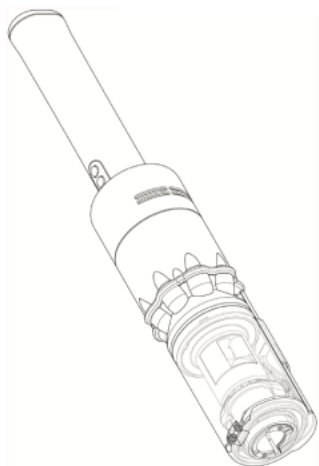

---

[11] 2016119.4M002

[15] 08-05-2020

[30] 11-12-2019 / EU / 007383674-0003

[51] Cl. 15-05

[54] 吸塵器

Vacuum cleaner

[73] Dyson Technology Limited  
Tetbury Hill, Malmesbury,  
Wiltshire, SN16 0RP,  
United Kingdom

[74] LIU, SHEN & ASSOCIATES  
Room 3716, 37/F, Sun Hung Kai Centre,  
30 Harbour Road,  
Wanchai, Hong Kong

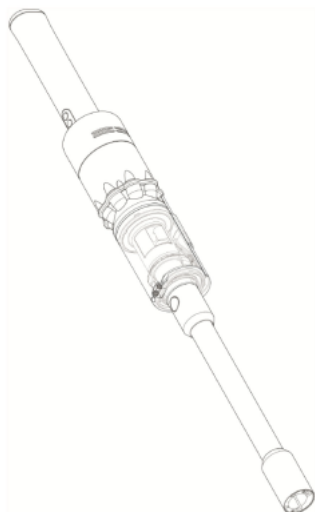

[11] 2016120.6M001

[15] 08-05-2020

[30] 08-11-2019 / EU / 007207303

[51] Cl. 12-08

[54] 車

Car

[73] FERRARI S.p.A.

Via Emilia Est 1163,

I-41100 Modena,

Italy

[74] CHINA PATENT AGENT (HONG KONG) LIMITED

22/F, Great Eagle Centre,

23 Harbour Road,

Wanchai, Hong Kong

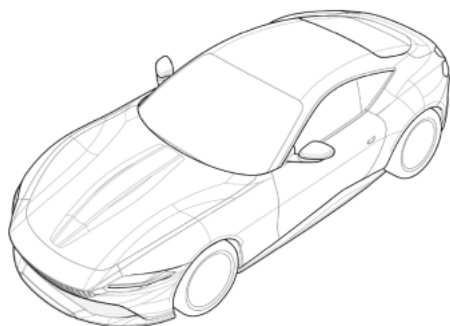

---

[11] 2016120.6M002

[15] 08-05-2020

[30] 08-11-2019 / EU / 007207303

[51] Cl. 12-08

[54] 車

Car

[73] FERRARI S.p.A.

Via Emilia Est 1163,

I-41100 Modena,

Italy

[74] CHINA PATENT AGENT (HONG KONG) LIMITED

22/F, Great Eagle Centre,

23 Harbour Road,

Wanchai, Hong Kong

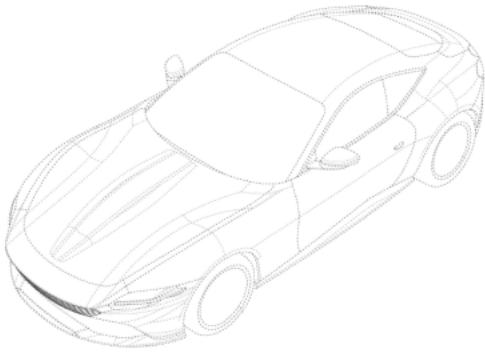

---

[11] 2016120.6M003

[15] 08-05-2020

[30] 08-11-2019 / EU / 007207303

[51] Cl. 12-16

[54] 車內飾

Car interior

[73] FERRARI S.p.A.

Via Emilia Est 1163,

I-41100 Modena,

Italy

[74] CHINA PATENT AGENT (HONG KONG) LIMITED

22/F, Great Eagle Centre,

23 Harbour Road,

Wanchai, Hong Kong

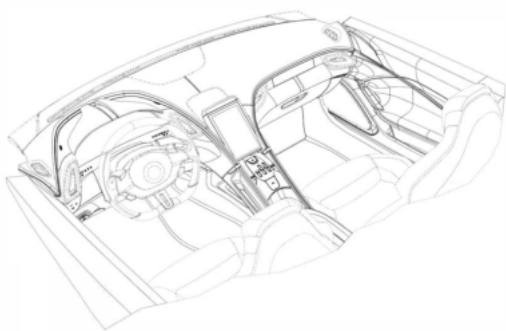

---

[11] 2016121.8M001

[15] 08-05-2020

[30] 08-11-2019 / EU / 007207790

[51] Cl. 12-08

[54] 車

Car

- [73] FERRARI S.p.A.  
Via Emilia Est 1163,  
I-41100 Modena,  
Italy
- [74] CHINA PATENT AGENT (HONG KONG) LIMITED  
22/F, Great Eagle Centre,  
23 Harbour Road,  
Wanchai, Hong Kong

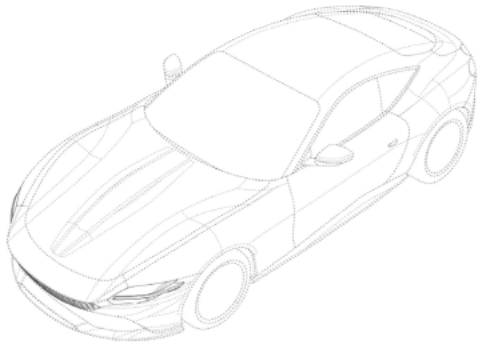

- 
- [11] 2016121.8M002
- [15] 08-05-2020
- [30] 08-11-2019 / EU / 007207790
- [51] Cl. 12-08
- [54] 車  
Car
- [73] FERRARI S.p.A.  
Via Emilia Est 1163,  
I-41100 Modena,  
Italy
- [74] CHINA PATENT AGENT (HONG KONG) LIMITED  
22/F, Great Eagle Centre,  
23 Harbour Road,  
Wanchai, Hong Kong

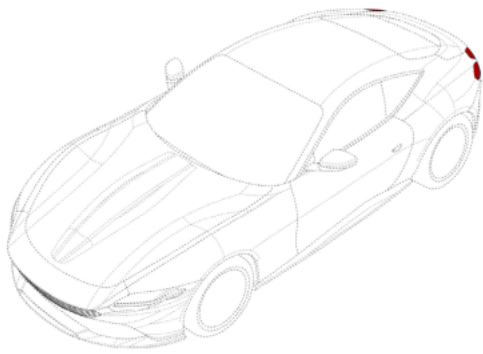

- 
- [11] 2016122.0
  - [15] 08-05-2020
  - [51] Cl. 15-99
  - [54] 智慧型機器人  
Intelligent robot
  - [73] 香港生產力促進局  
Hong Kong Productivity Council  
香港九龍  
達之路 78 號  
生產力大樓
  - [74] 香港匯澤知識產權代理有限公司  
香港九龍  
尖沙咀廣東道 5 號  
海港城海洋中心 8 樓 826 室

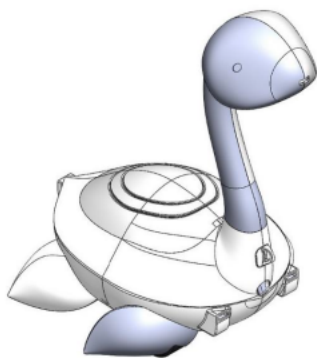

- 
- [11] 2016123.2
  - [15] 08-05-2020
  - [30] 08-11-2019 / US / 29/712,529
  - [51] Cl. 14-01

[54] 視聽會議設備  
Audio-video conferencing device

[73] Bose Corporation  
The Mountain, MS 3B1,  
Framingham, Massachusetts 01701-9168,  
United States

[74] WENPING PATENT & TRADE MARK AGENT LIMITED  
1701 Tung Wai Commercial Building,  
111 Gloucester Road,  
Hong Kong

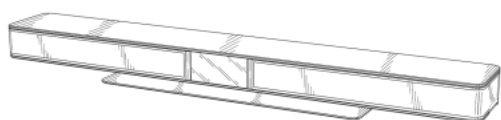

---

[11] 2016124.4

[15] 08-05-2020

[30] 11-11-2019 / US / 29/712,711

[51] Cl. 13-02

[54] 充電盒  
Charging case

[73] Bose Corporation  
The Mountain, MS 3B1,  
Framingham, Massachusetts 01701-9168,  
United States

[74] WENPING PATENT & TRADE MARK AGENT LIMITED  
1701 Tung Wai Commercial Building,  
111 Gloucester Road,  
Hong Kong

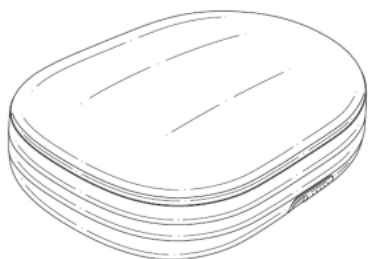

[11] 2016125.7

[15] 08-05-2020

[51] Cl. 9-01

[54] 瓶子  
Bottle

[73] 志同塑膠工業股份有限公司  
TARGET PLASTIC INDUSTRIAL CORPORATION  
台灣  
台北市文山區  
萬盛街 124 號 1 樓

[74] 中港知識產權有限公司  
香港  
港灣道 1 號會展廣場  
辦公大樓 30 樓 3011 室



---

[11] 2016130.7

[15] 11-05-2020

[51] Cl. 6-06

[54] 座檯式屏擋  
Shield stand for desktop

[73] BRIGHT MIND LIMITED  
Room 906, 9/F., Kowloon Bay Industrial Center,  
15 Wang Hoi Road, Kowloon Bay,  
Kowloon, Hong Kong

[74] HONG KONG INTELLECTUAL PROPERTY ADVISORY SERVICE LIMITED  
Unit 1701, 17/F., Ew International Tower,  
120 Texaco Road,



Tsuen Wan, New Territories,  
Hong Kong



---

[11] 2016133.3M001

[15] 11-05-2020

[30] 09-12-2019 / CA, AM, AZ, BZ, BA, GE, LI, MK, MD, MC, MN, ME,  
MA, NO, OM, RU, SG, CH, TN, TR, UA, GB, EU, AL, KG / DM/205  
267

[51] Cl. 11-01

[54] 指環  
Ring

[73] Harry Winston SA  
Chemin du Tourbillon 8,  
CH-1228 Plan-les-Ouates,  
Switzerland

[74] SPRUSON & FERGUSON (HONG KONG) LIMITED  
5001 Hopewell Centre,  
183 Queen's Road East,  
Wan Chai, Hong Kong



---

[11] 2016133.3M002

[15] 11-05-2020

- [30] 09-12-2019 / CA, AM, AZ, BZ, BA, GE, LI, MK, MD, MC, MN, ME, MA, NO, OM, RU, SG, CH, TN, TR, UA, GB, EU, AL, KG / DM/205 267
- [51] Cl. 11-01
- [54] 指環  
Ring
- [73] Harry Winston SA  
Chemin du Tourbillon 8,  
CH-1228 Plan-les-Ouates,  
Switzerland
- [74] SPRUSON & FERGUSON (HONG KONG) LIMITED  
5001 Hopewell Centre,  
183 Queen's Road East,  
Wan Chai, Hong Kong



- 
- [11] 2016135.8
- [15] 12-05-2020
- [51] Cl. 23-04
- [54] 空氣淨化器  
Air purifier
- [73] 盛開蓮花有限公司  
Bloomy Lotus Ltd  
Unit 4711, 47/F., The Center,  
99 Queen's Road Central, Central,  
Hong Kong
- [74] FEDERATION OF HONG KONG INDUSTRIES  
31/F, Billion Plaza,  
8 Cheung Yue Street,  
Cheung Sha Wan, Kowloon,  
Hong Kong

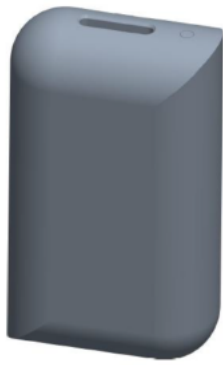

---

[11] 2016136.0

[15] 12-05-2020

[51] Cl. 2-04

[54] 鞋的外底  
Outsole

[73] 港昌鞋業(香港)有限公司  
香港新界  
葵涌健康街18號  
恒亞中心6樓12-14室

[74] ZOE WONG (KONG CHEONG SHOES (HK) LTD.)  
Rm 12-14, 6/F., Trans Asia Ctr,  
No.18 Kin Hong Street,  
Kwai Chung, N.T., Hong Kong



---

[11] 2016137.2

[15] 12-05-2020

[30] 13-11-2019 / CN / 201930624458.8

[51] Cl. 15-05

[54] 洗碗機

Dish-washing machine

[73] 翰恩生活電器科技(佛山)有限公司

中國內地

廣東省佛山市順德區容桂容里居委會

昌富西路3號天富來國際工業城4座203、204號

陳繼雄

中國內地

廣東省佛山市順德區容桂容里居委會

昌富西路3號天富來國際工業城4座203、204號

陳子華

中國內地

廣東省佛山市順德區容桂容里居委會

昌富西路3號天富來國際工業城4座203、204號

[74] 百睿知識產權有限公司

香港新界

沙田香港科學園

科技大道西10號浚湖樓617室

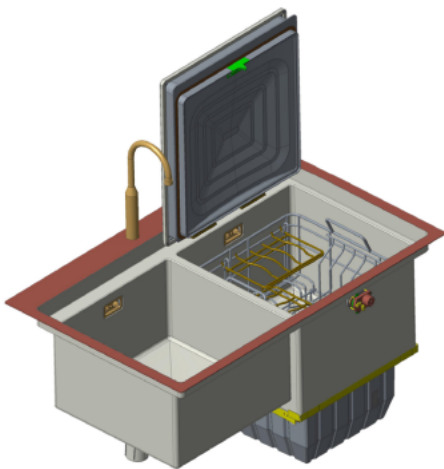

---

[11] 2016140.8

[15] 13-05-2020

[51] Cl. 12-16

[54] 汽車尾翼

Car rear spoiler

[73] SHIN WA KWONG

Flat/Rm B6-6A, Roof 16/F,

Delya Industrial Centre,  
7 Shek Pai Tau Road,  
Tuen Mun, N.T., Hong Kong

- [74] ACCOLADE IP LIMITED  
10/F, Fu Fai Comm. Ctr.,  
27 Hillier Street,  
Sheung Wan, Hong Kong



- 
- [11] 2016141.0  
[15] 13-05-2020  
[30] 22-11-2019 / CN / 201930645128.7  
[51] Cl. 15-02  
[54] 水泵配件  
Part of water pump  
[73] 翰恩生活電器科技（佛山）有限公司  
中國內地  
廣東省佛山市順德區容桂容里居委會  
昌富西路 3 號天富來國際工業城 4 座 203、204 號  
  
陳繼雄  
中國內地  
廣東省佛山市順德區容桂容里居委會  
昌富西路 3 號天富來國際工業城 4 座 203、204 號  
  
陳子華  
中國內地  
廣東省佛山市順德區容桂容里居委會  
昌富西路 3 號天富來國際工業城 4 座 203、204 號  
[74] 百睿知識產權有限公司  
香港新界  
沙田香港科學園  
科技大道西 10 號浚湖樓 617 室

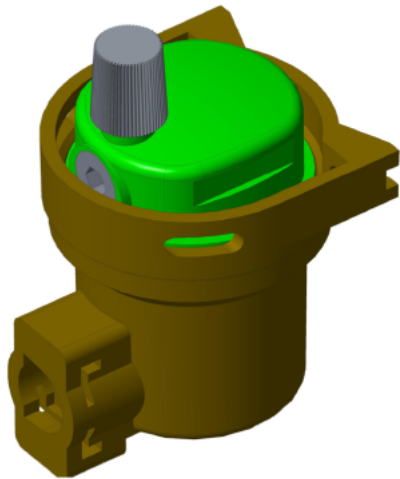

---

[11] 2016142.2M001

[15] 13-05-2020

[51] Cl. 19-01

Cl. 19-03

Cl. 19-04

Cl. 19-08

[54] 印刷品

Printed matter

[73] BESTIME INTERNATIONAL TRADING LIMITED

Flat 1, 22/F Assun Pacific Centre,

No. 41 Tsun Yip Street,

Kwun Tong, Kowloon, Hong Kong

[74] IPMS CONSULTANTS LIMITED

Unit 2004B, 20/F, Tower 5,

China Hong Kong City,

33 Canton Road,

Tsim Sha Tsui, Kowloon, Hong Kong

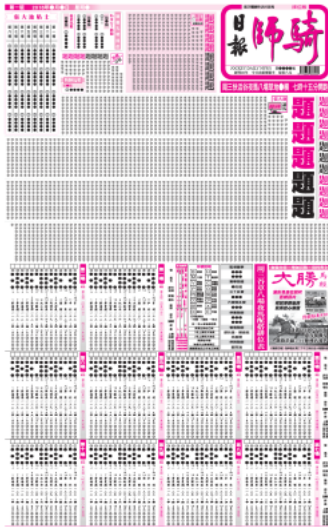

[11] 2016142.2M002

[15] 13-05-2020

[51] Cl. 19-01

Cl. 19-03

Cl. 19-04

Cl. 19-08

[54] 印刷品

Printed matter

[73] BESTIME INTERNATIONAL TRADING LIMITED

Flat 1, 22/F Assun Pacific Centre,

No. 41 Tsun Yip Street,

Kwun Tong, Kowloon, Hong Kong

[74] IPMS CONSULTANTS LIMITED

Unit 2004B, 20/F, Tower 5,

China Hong Kong City,

33 Canton Road,

Tsim Sha Tsui, Kowloon, Hong Kong



- [11] 2016142.2M003
- [15] 13-05-2020
- [51] C1. 19-01  
C1. 19-03  
C1. 19-04  
C1. 19-08
- [54] 印刷品  
Printed matter
- [73] BESTIME INTERNATIONAL TRADING LIMITED  
Flat 1, 22/F Assun Pacific Centre,  
No. 41 Tsun Yip Street,  
Kwun Tong, Kowloon, Hong Kong
- [74] IPMS CONSULTANTS LIMITED  
Unit 2004B, 20/F, Tower 5,  
China Hong Kong City,  
33 Canton Road,  
Tsim Sha Tsui, Kowloon, Hong Kong

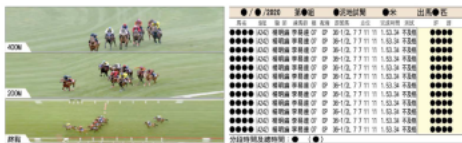

- [11] 2016149.7M001
- [15] 14-05-2020



- [30] 13-12-2019 / CA, AM, AZ, BZ, BA, GE, LI, MK, MD, MC, MN, ME, MA, NO, OM, RU, SG, CH, TN, TR, UA, GB, EU, AL, KG / DM/205 309
- [51] Cl. 11-01
- [54] 指環  
Ring
- [73] HARRY WINSTON SA  
Chemin du Tourbillon 8,  
CH-1228 Plan-les-Ouates,  
Switzerland
- [74] SPRUSON & FERGUSON (HONG KONG) LIMITED  
5001 Hopewell Centre,  
183 Queen's Road East,  
Wan Chai, Hong Kong



- 
- [11] 2016149.7M002
- [15] 14-05-2020
- [30] 13-12-2019 / CA, AM, AZ, BZ, BA, GE, LI, MK, MD, MC, MN, ME, MA, NO, OM, RU, SG, CH, TN, TR, UA, GB, EU, AL, KG / DM/205 309
- [51] Cl. 11-01
- [54] 指環  
Ring
- [73] HARRY WINSTON SA  
Chemin du Tourbillon 8,  
CH-1228 Plan-les-Ouates,  
Switzerland
- [74] SPRUSON & FERGUSON (HONG KONG) LIMITED  
5001 Hopewell Centre,  
183 Queen's Road East,  
Wan Chai, Hong Kong



---

[11] 2016149.7M003

[15] 14-05-2020

[30] 13-12-2019 / CA, AM, AZ, BZ, BA, GE, LI, MK, MD, MC, MN, ME, MA, NO, OM, RU, SG, CH, TN, TR, UA, GB, EU, AL, KG / DM/205309

[51] Cl. 11-01

[54] 項鍊  
Necklace

[73] HARRY WINSTON SA  
Chemin du Tourbillon 8,  
CH-1228 Plan-les-Ouates,  
Switzerland

[74] SPRUSON & FERGUSON (HONG KONG) LIMITED  
5001 Hopewell Centre,  
183 Queen's Road East,  
Wan Chai, Hong Kong



---

[11] 2016153.5

[15] 15-05-2020

[51] Cl. 28-03

[54] 美容儀器  
Beauty apparatus

[73] Trophy Skin, Inc.  
4372 Kenmare Trail Frisco,  
Texas 75034,  
United States

[74] TRADEMARKCN COMPANY LIMITED  
Block A, 4/F., Granville Building,  
14 Granville Road,  
Tsim Sha Tsui, Kowloon, Hong Kong

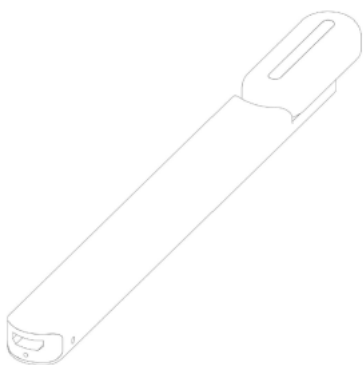

---

[11] 2016154.7

[15] 15-05-2020

[51] Cl. 28-03

[54] 美容儀器  
Beauty apparatus

[73] Trophy Skin, Inc.  
4372 Kenmare Trail Frisco,  
Texas 75034,  
United States

[74] TRADEMARKCN COMPANY LIMITED  
Block A, 4/F., Granville Building,  
14 Granville Road,  
Tsim Sha Tsui, Kowloon, Hong Kong



---

[11] 2016155.0

[15] 15-05-2020

[51] Cl. 25-02

[54] 水馬

Water barrier

[73] 穩立企業發展有限公司

Winner Enterprises Development Limited

105 G/F., Tai Hang Tsz Tong Tsuen,

Tai Po, N.T.,

Hong Kong

[74] HONG KONG INTELLECTUAL PROPERTY AGENT LIMITED

Unit 230, 2/F, Building 12W,

No. 12 Science Park West Avenue,

Phase 3, Hong Kong Science Park,

Pak Shek Kok, N.T.,

Hong Kong

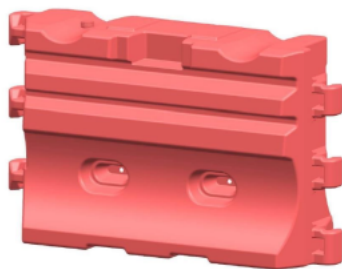

---

[11] 2016156.2M001

[15] 15-05-2020

[51] Cl. 8-08

[54] 配件  
Fitting

[73] 天上野有限公司  
Titan Limited  
香港九龍  
油塘高輝道 17 號  
油塘工業城 A2 座 13 字樓 13-16 室

[74] 卓遠知識產權有限公司  
香港上環  
禧利街 27 號  
富輝商業中心 10 樓

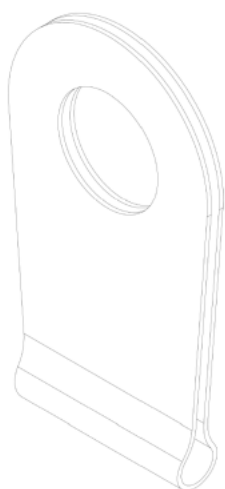

---

[11] 2016156.2M002

[15] 15-05-2020

[51] Cl. 8-08

[54] 配件  
Fitting

[73] 天上野有限公司  
Titan Limited  
香港九龍  
油塘高輝道 17 號  
油塘工業城 A2 座 13 字樓 13-16 室

[74] 卓遠知識產權有限公司  
香港上環  
禧利街 27 號  
富輝商業中心 10 樓

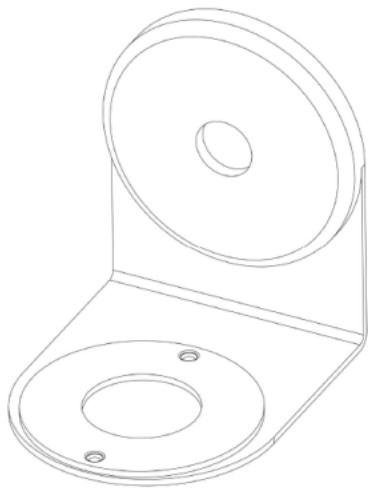

---

[11] 2016157.4

[15] 15-05-2020

[51] Cl. 11-01

[54] 手鐲

Bangle

[73] 古名晉

KOO, Koon Man

Shop 116, Windsor House,

Causeway Bay,

Hong Kong

[74] ACCOLADE IP LIMITED

10/F, Fu Fai Comm. Ctr.,

27 Hillier Street,

Sheung Wan, Hong Kong



---

[11] 2016161.2

[15] 19-05-2020

[30] 13-03-2020 / CN / 202030084686.3

[51] Cl. 24-02

[54] 電極  
Electrode

[73] 鴻圖醫療器材(東莞)有限公司  
Modern Medical Equipment Mfg. (Dongguan) Ltd.  
中國內地  
523466 廣東省東莞市橫瀝山廈管理區  
康樂路東興工業區

[74] 中港專利有限公司  
香港  
港灣道 1 號會展廣場  
辦公大樓 30 樓 3012 室

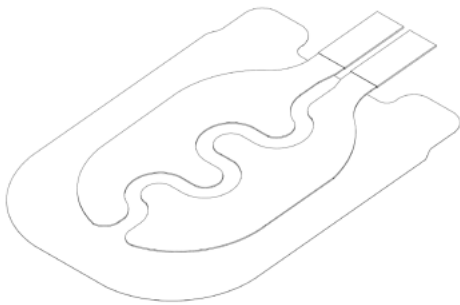



香港特別行政區政府知識產權署外觀設計註冊處  
The Government of the Hong Kong Special Administrative Region  
Designs Registry, Intellectual Property Department

根據註冊外觀設計條例第 28 條，下列註冊外觀設計因未繳續期費而停止有效。

各組記項按註冊外觀設計停止有效日期及註冊編號先後次序排列。

**Registered designs ceased through non-payment of renewal fees under section 28 of the Registered Designs Ordinance. Entries are listed below under their expiry dates.**

**25-06-2020 - 01-07-2020**

<b>25-06-2020</b>	1501390.3M002	1001212.2
1501373.7		1501411.9M001
1501374.9M001	<b>29-06-2020</b>	1501411.9M002
1501374.9M002	0501569.2	1501411.9M003
1501374.9M003	0501570.4M001	1501411.9M004
1501374.9M004	0501570.4M002	1501411.9M005
1501374.9M005	0501570.4M003	1501412.1
1501374.9M006	0503022.4	1501413.3
1501374.9M007	1001195.5	
1501375.2	1501394.1	
1501376.4	1501396.6	
	1501397.8	
<b>26-06-2020</b>	1501398.0	
0501530.0	1501399.2	
1501381.4M001	1501400.6	
1501381.4M002	1501401.8	
	1501402.0	
<b>27-06-2020</b>	1501403.2	
0501534.8M005	1501404.4	
0501540.1M001	1501405.7	
0501540.1M002	1501406.9	
1001188.0M002	1501407.1	
1501382.6M001	1501623.9M001	
1501382.6M002	1501623.9M002	
1501383.8	1501623.9M003	
	1501623.9M004	
<b>28-06-2020</b>		
0501552.6	<b>01-07-2020</b>	
1501385.3	1001200.7M001	
1501388.9M001	1001200.7M002	
1501388.9M002	1001200.7M003	
1501389.1M001	1001201.9	
1501389.1M002	1001210.8	
1501390.3M001	1001211.0	





香港特別行政區政府知識產權署外觀設計註冊處

The Government of the Hong Kong Special Administrative Region

Designs Registry, Intellectual Property Department

根據註冊外觀設計規則第 31 條刪除的註冊外觀設計。各組記項按註冊外觀設計刪除日期及註冊編號先後次序排列。

**Registered designs removed under section 31 of the Registered Designs Rules. Entries are listed below under their removal dates.**

**07-08-2020 - 13-08-2020**

<b>07-08-2020</b>	1402439.8	1500005.8
1402424.6		1500007.2M001
1402425.9	<b>12-08-2020</b>	1500007.2M002
	0902232.2M001	1500007.2M003
<b>09-08-2020</b>	0902232.2M002	
0412966.6	0902232.2M003	
0412967.8	0902232.2M004	
0902209.4M001	0902232.2M005	
0902209.4M002	0902232.2M006	
0902210.6	0902232.2M009	
0902211.8	0902233.4M001	
0902213.2M001	0902233.4M002	
0902213.2M002	0902233.4M003	
9911761.4M002	0902233.4M004	
9911763.8M002	0902233.4M005	
	0902233.4M006	
<b>10-08-2020</b>	1402447.5M001	
0902214.4	1402447.5M002	
0902215.7	1402447.5M003	
1402426.1	1402449.9M001	
1402427.3	1402449.9M002	
1402428.5	1402449.9M003	
1402430.9	1402451.3M002	
9911765.3	1402452.5	
9911768.9	1402453.7	
<b>11-08-2020</b>	<b>13-08-2020</b>	
0902227.2M001	1500001.9	
0902227.2M002	1500002.1M001	
1402434.7M001	1500002.1M002	
1402434.7M002	1500003.3M001	
1402436.2	1500003.3M002	
1402437.4	1500004.5M001	
1402438.6	1500004.5M002	