

香港知識產權公報

Hong Kong Intellectual Property Journal

2020 年 4 月 29 日

29 April 2020

目錄 Contents

根據註冊外觀設計條例第 25 條註冊的外觀設計

Designs Registered under section 25 of the Registered Designs Ordinance

按註冊編號排列

Arranged by Registration Number

根據註冊外觀設計條例(第 522 章)公布的其他公告

Other Notices Published under the Registered Designs Ordinance (Cap. 522)

根據註冊外觀設計條例第 28 條, 註冊外觀設計因未繳續期費而停止有效

Registered designs ceased through non-payment of renewal fees under section 28 of the Registered Designs Ordinance

根據註冊外觀設計條例第 30 條放棄的外觀設計的註冊

Surrender of Registration of Design under section 30 of the Registered Designs Ordinance

根據註冊外觀設計規則第 31 條刪除的註冊外觀設計

Registered designs removed under section 31 of the Registered Designs Rules

以下事項沒有記錄

No Records for the Following Matters

根據註冊外觀設計規則第 37 條, 向處長作出轉介

Reference to Registrar under section 37 of the Registered Designs Rules

根據註冊外觀設計條例第 45 條, 撤銷註冊

Revocation of Registration under section 45 of the Registered Designs Ordinance

根據註冊外觀設計規則第 46 條，向法院作出轉介

Reference to Court under section 46 of the Registered Designs Rules

根據註冊外觀設計規則第 63 條對不符合規定之處作出糾正

Rectification of Irregularities under section 63 of the Registered Designs Rules

根據註冊外觀設計條例第 66 條，糾正註冊紀錄冊

Rectification of Register under section 66 of the Registered Designs Ordinance

根據註冊外觀設計條例第 67 條 更正註冊紀錄冊內的錯誤

Correction of errors in Register under section 67 of the Registered Designs Ordinance

根據註冊外觀設計條例第 67 及 76 條，更正註冊紀錄冊內及已提交文件中的錯誤

Correction of Errors in Register and in Filed Documents under sections 67 and 76 of the Registered Designs Ordinance

根據註冊外觀設計條例第 76 條，更正已提交文件中的錯誤

Correction of errors in filed documents under section 76 of the Registered Designs Ordinance

勘誤

Corrigendum

註冊外觀設計公告註釋

Notes on advertisements of registration of designs

方括號表示下列資料：

Square brackets indicate the following data：

[11] 註冊編號 Registration number / 聯合王國註冊編號 United Kingdom registration number

[15] 註冊日期 Registration date / 當作註冊日期 Deemed registration date / 聯合王國註冊日期 United Kingdom registration date

[17] 註冊有效期屆滿日期 Expiry date of the period of registration

[22] 提交日期 Filing date / 當作提交日期 Deemed filing date / 聯合王國提交日期 United Kingdom filing date

[30] 聲稱享有的優先權（提交日期 / 巴黎公約國或世界貿易組織成員 / 申請編號） Priority claimed (filing date / Paris Convention country or WTO member / application number)

[51] 國際外觀設計分類號（洛迦諾分類號） International Classification of designs (Locarno Classification)

[54] 物品 Article

[55] 外觀設計的表述 Representation of the design

[62] 分開前的申請編號及提交日期 Application number before division and filing date

[66] 過往註冊的聯繫外觀設計註冊編號 / 日期 Registration No. / Date of Previous Registration for Association

[72] 設計人 Designer

[73] 擁有人姓名和地址 Name and address of the owner

[74] 代理人 Agent / 送達地址 Address for service



香港特別行政區政府知識產權署外觀設計註冊處

The Government of the Hong Kong Special Administrative Region

Designs Registry, Intellectual Property Department

根據註冊外觀設計條例第 25 條註冊的外觀設計

Designs registered under section 25 of the Registered Designs Ordinance

按註冊編號排列

Arranged by Registration Number

[11] 1913191.9

[15] 14-03-2019

[51] Cl. 25-02

[54] 隔音窗

Soundproofing window

[73] 建築聲學有限公司

Architectural Acoustics Limited

香港九龍尖沙嘴

寶勒巷 29 號

寶昌商業大廈 2 樓

[74] 建築聲學有限公司

香港九龍尖沙嘴

寶勒巷 29 號

寶昌商業大廈 2 樓

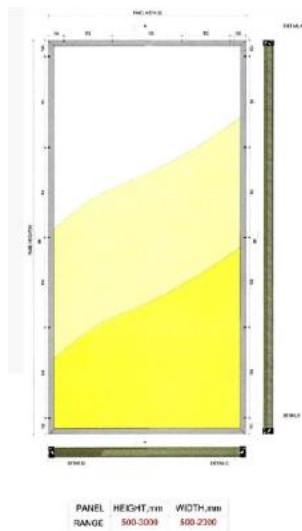

[11] 1914330.6M001

[15] 29-07-2019

[51] Cl. 13-02

[54] 鋁無線充電板

Aluminum wireless charging pad

[73] DESIGN POOL LIMITED

2/F, Eastown Building

41 Lockhart Road, Wanchai

HONG KONG

i

[74] DESIGN POOL LIMITED

2/F, Eastown Building

41 Lockhart Road, Wanchai

HONG KONG



[11] 1914330.6M002

[15] 29-07-2019

[51] Cl. 13-02

[54] 交流電源轉換插頭連直流真皮電線

AC power adapter with DC genuine leather strap cable

[73] DESIGN POOL LIMITED

2/F, Eastown Building

41 Lockhart Road, Wanchai

HONG KONG

i

[74] DESIGN POOL LIMITED

2/F, Eastown Building

41 Lockhart Road, Wanchai

HONG KONG



[11] 1914915.8M001

[15] 31-10-2019

[30] 12-09-2019 / CA / 189801

[51] Cl. 21-03

[54] 水滑道裝置

Water ride feature

[73] ProSlide Technology Inc.

2650 Queensview Drive, Suite 150

Ottawa, Ontario K2B 8H6

CANADA

[74] AWA ASIA LIMITED

Suite 1411, 14/F Leighton Centre

77 Leighton Road, Causeway Bay

HONG KONG

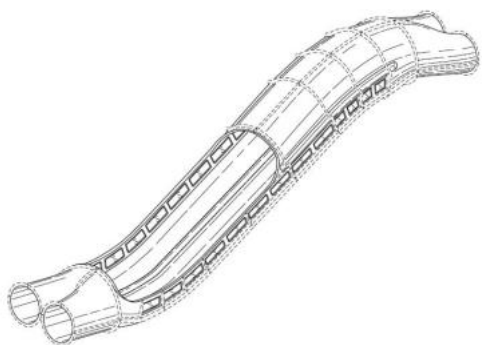

[11] 1914915.8M002

[15] 31-10-2019

[30] 12-09-2019 / CA / 189801

[51] Cl. 21-03

[54] 水滑道裝置

Water ride feature

[73] ProSlide Technology Inc.

2650 Queensview Drive, Suite 150

Ottawa, Ontario K2B 8H6

CANADA

[74] AWA ASIA LIMITED

Suite 1411, 14/F Leighton Centre

77 Leighton Road, Causeway Bay

HONG KONG

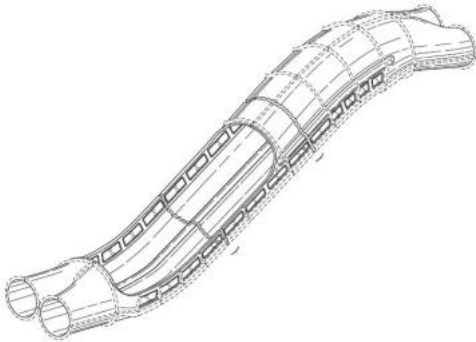

[11] 1914915.8M003

[15] 31-10-2019

[30] 12-09-2019 / CA / 189801

[51] Cl. 21-03

[54] 水滑道裝置

Water ride feature

[73] ProSlide Technology Inc.

2650 Queensview Drive, Suite 150

Ottawa, Ontario K2B 8H6

CANADA

[74] AWA ASIA LIMITED

Suite 1411, 14/F Leighton Centre

77 Leighton Road, Causeway Bay

HONG KONG

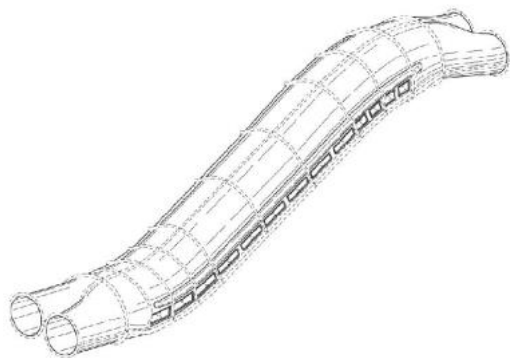

[11] 1915071.7M001

[15] 25-11-2019

[30] 11-07-2019 / DE / 402019100749.0

[51] Cl. 21-01

[54] 玩具汽車

Toy vehicle

[73] VOLKSWAGEN AKTIENGESELLSCHAFT

38436 WOLFSBURG

GERMANY

[74] CHINA PATENT AGENT (HONG KONG) LIMITED

22/F, Great Eagle Centre, 23 Harbour Road,

Wanchai

HONG KONG



[11] 1915071.7M002

[15] 25-11-2019

[30] 11-07-2019 / DE / 402019100749.0

[51] Cl. 21-01

[54] 玩具汽車

Toy vehicle

[73] VOLKSWAGEN AKTIENGESELLSCHAFT

38436 WOLFSBURG

GERMANY

- [74] CHINA PATENT AGENT (HONG KONG) LIMITED
22/F, Great Eagle Centre, 23 Harbour Road,
Wanchai
HONG KONG



[11] 1915075.6

[15] 25-11-2019

[51] Cl. 23-04

[54] 香薰機

Aroma diffuser

[73] 盛開蓮花有限公司

Bloomy Lotus Ltd

Unit 4711, 47/F., The Center,

99 Queen's Road Central, Central,

HONG KONG

[74] FEDERATION OF HONG KONG INDUSTRIES

31/F, Billion Plaza,

8 Cheung Yue Street, Cheung Sha Wan, Kowloon

HONG KONG

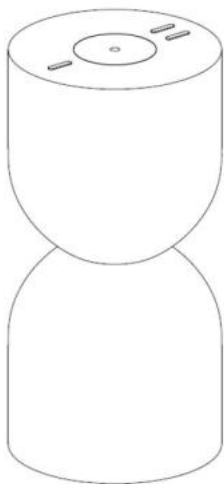

[11] 1915076.8M001

[15] 25-11-2019

[30] 01-06-2019 / US / 29/693,355

[51] Cl. 14-04

[54] 用於電子設備的圖形用戶界面

Graphical user interface for electronic device

[73] 蘋果公司

APPLE INC.

ONE APPLE PARK WAY CUPERTINO

CALIFORNIA 95014

UNITED STATES

[74] BARRON & YOUNG INTELLECTUAL PROPERTY LIMITED

Suite 617, Lakeside 2

No. 10 Science Park West Avenue, Hong Kong Science Park,
Shatin, N.T.

HONG KONG

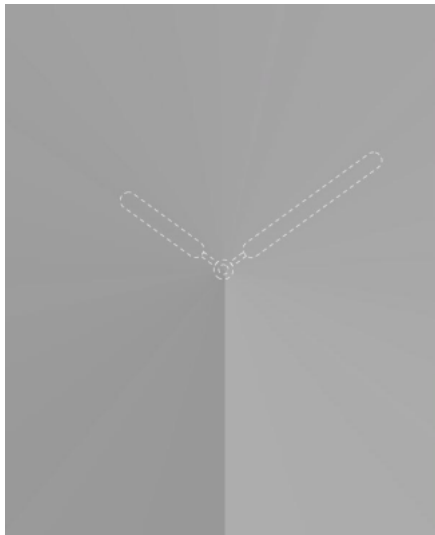

[11] 1915076.8M002

[15] 25-11-2019

[30] 01-06-2019 / US / 29/693,355

[51] Cl. 14-04

[54] 用於電子設備的圖形用戶界面

Graphical user interface for electronic device

[73] 蘋果公司

APPLE INC.

ONE APPLE PARK WAY CUPERTINO

CALIFORNIA 95014

UNITED STATES

[74] BARRON & YOUNG INTELLECTUAL PROPERTY LIMITED

Suite 617, Lakeside 2

No. 10 Science Park West Avenue, Hong Kong Science Park,

Shatin, N.T.

HONG KONG

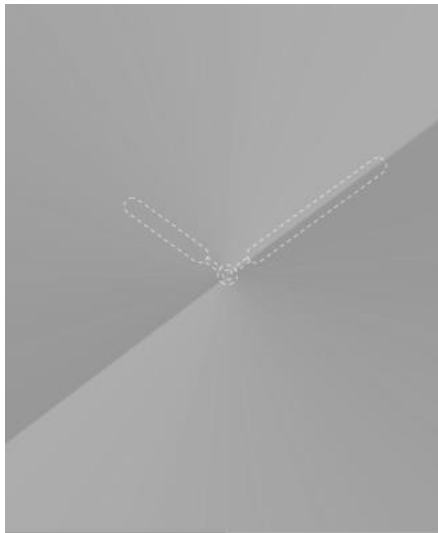

[11] 1915076.8M003

[15] 25-11-2019

[30] 01-06-2019 / US / 29/693,355

[51] Cl. 14-04

[54] 用於電子設備的圖形用戶界面

Graphical user interface for electronic device

[73] 蘋果公司

APPLE INC.

ONE APPLE PARK WAY CUPERTINO

CALIFORNIA 95014

UNITED STATES

[74] BARRON & YOUNG INTELLECTUAL PROPERTY LIMITED

Suite 617, Lakeside 2

No. 10 Science Park West Avenue, Hong Kong Science Park,

Shatin, N.T.

HONG KONG



[11] 1915076.8M004

[15] 25-11-2019

[30] 01-06-2019 / US / 29/693,355

[51] Cl. 14-04

[54] 用於電子設備的圖形用戶界面

Graphical user interface for electronic device

[73] 蘋果公司

APPLE INC.

ONE APPLE PARK WAY CUPERTINO

CALIFORNIA 95014

UNITED STATES

[74] BARRON & YOUNG INTELLECTUAL PROPERTY LIMITED

Suite 617, Lakeside 2

No. 10 Science Park West Avenue, Hong Kong Science Park,
Shatin, N.T.

HONG KONG

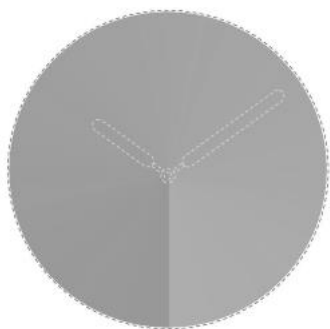

[11] 1915076.8M005

[15] 25-11-2019

[30] 01-06-2019 / US / 29/693,355

[51] Cl. 14-04

[54] 用於電子設備的圖形用戶界面

Graphical user interface for electronic device

[73] 蘋果公司

APPLE INC.

ONE APPLE PARK WAY CUPERTINO

CALIFORNIA 95014

UNITED STATES

[74] BARRON & YOUNG INTELLECTUAL PROPERTY LIMITED

Suite 617, Lakeside 2

No. 10 Science Park West Avenue, Hong Kong Science Park,
Shatin, N.T.

HONG KONG

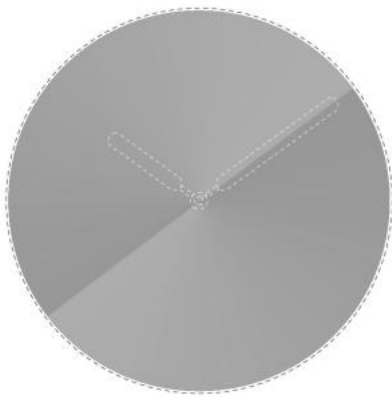

[11] 1915076.8M006

[15] 25-11-2019

[30] 01-06-2019 / US / 29/693,355

[51] Cl. 14-04

[54] 用於電子設備的圖形用戶界面

Graphical user interface for electronic device

[73] 蘋果公司

APPLE INC.

ONE APPLE PARK WAY CUPERTINO

CALIFORNIA 95014

UNITED STATES

[74] BARRON & YOUNG INTELLECTUAL PROPERTY LIMITED

Suite 617, Lakeside 2

No. 10 Science Park West Avenue, Hong Kong Science Park,
Shatin, N.T.

HONG KONG

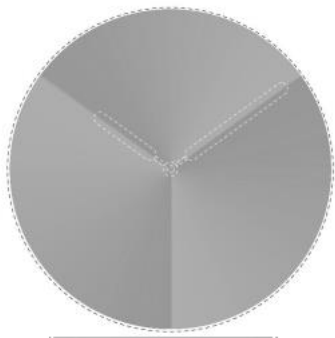

[11] 1915078.2

[15] 26-11-2019

[51] Cl. 23-04

[54] 香薰機

Aroma diffuser

[73] 盛開蓮花有限公司

Bloomy Lotus Ltd

Unit 4711, 47/F., The Center,

99 Queen's Road Central, Central,

HONG KONG

[74] FEDERATION OF HONG KONG INDUSTRIES

31/F, Billion Plaza,

8 Cheung Yue Street, Cheung Sha Wan, Kowloon

HONG KONG

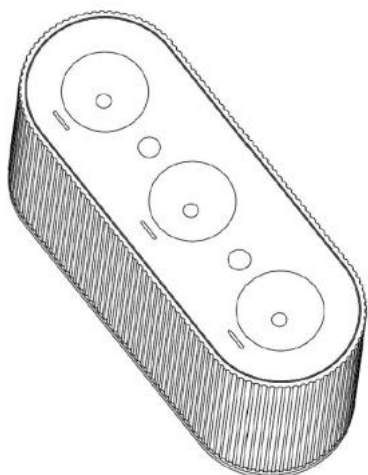

[11] 1915080.6

[15] 26-11-2019

[30] 28-05-2019 / FR / 2019-2477

[51] Cl. 16-06

[54] 太陽眼鏡
Sunglasses

[73] LOUIS VUITTON MALLETIER
2 rue du Pont-Neuf
75001 Paris
FRANCE

[74] BAKER & MCKENZIE
14TH FLOOR, ONE TAIKOO PLACE,
979 KING'S ROAD, QUARRY BAY,
HONG KONG



[11] 1915081.8

[15] 26-11-2019

[30] 27-05-2019 / FR / 2019-2445

[51] Cl. 3-01

[54] 袋
Bag

[73] LOUIS VUITTON MALLETIER
2 rue du Pont-Neuf
75001 Paris
FRANCE

[74] BAKER & MCKENZIE
14TH FLOOR, ONE TAIKOO PLACE,
979 KING'S ROAD, QUARRY BAY,
HONG KONG



[11] 1915082.0

[15] 26-11-2019

[30] 27-05-2019 / FR / 2019-2446

[51] Cl. 3-01

[54] 袋
Bag

[73] LOUIS VUITTON MALLETIER
2 rue du Pont-Neuf
75001 Paris
FRANCE

[74] BAKER & MCKENZIE
14TH FLOOR, ONE TAIKOO PLACE,
979 KING'S ROAD, QUARRY BAY,
HONG KONG



- [11] 1915085.7
[15] 26-11-2019
[51] Cl. 9-05
[54] 包裝袋
Packaging bag
[73] 唐琼英
TANG QIONG YING
中國內地
重慶市沙坪壩區
康居苑 2 號 7-3
[74] 卓遠知識產權有限公司
香港
上環禧利街 27 號
富輝商業中心 10 樓

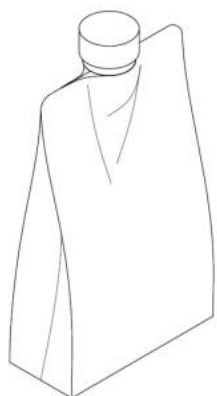

-
- [11] 1915086.9
[15] 26-11-2019
[30] 30-10-2019 / CN / 201930594777.9
[51] Cl. 13-03
[54] 多功能轉接器
Multi-functional adapter
[73] 廣東高普達集團股份有限公司
GUANGDONG GOPOD GROUP CO., LTD.
中國內地
廣東省深圳市龍華新區大浪街道同勝社區華榮路聯建科技工業園
廠房 8 棟 4, 5, 6 樓
[74] 中一聯合國際知識產權有限公司
香港

九龍尖沙咀漆咸道南 45-51 號
其士大廈 803 室

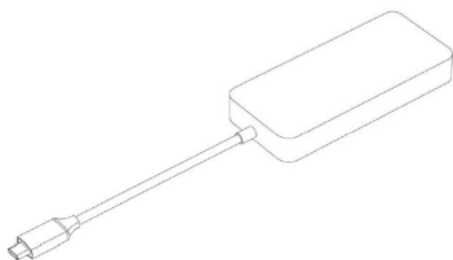

[11] 1915087.1

[15] 26-11-2019

[30] 30-10-2019 / CN / 201930594819.9

[51] Cl. 13-03

[54] 多功能轉接器

Multi-functional adapter

[73] 廣東高普達集團股份有限公司

GUANGDONG GOPOD GROUP CO., LTD.

中國內地

廣東省深圳市龍華新區大浪街道同勝社區華榮路聯建科技工業園

廠房 8 棟 4, 5, 6 樓

[74] 中一聯合國際知識產權有限公司

香港

九龍尖沙咀漆咸道南 45-51 號

其士大廈 803 室

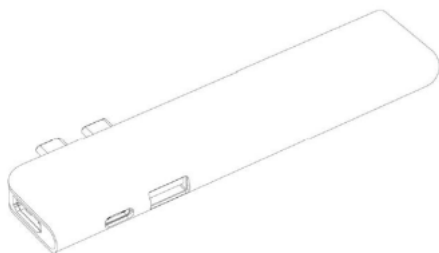

[11] 1915088.3M001

[15] 26-11-2019

[30] 30-10-2019 / CN / 201930595403.9

[51] Cl. 13-03

[54] 多功能轉接器

Multi-functional adapter

[73] 廣東高普達集團股份有限公司
GUANGDONG GOPOD GROUP CO., LTD.
中國內地
廣東省深圳市龍華新區大浪街道同勝社區華榮路聯建科技工業園
廠房 8 棟 4, 5, 6 樓

[74] 中一聯合國際知識產權有限公司
香港九龍
尖沙咀漆咸道南 45-51 號
其士大廈 803 室

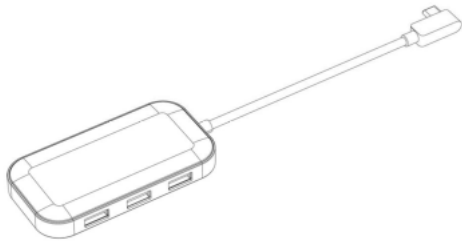

[11] 1915088.3M002

[15] 26-11-2019

[30] 30-10-2019 / CN / 201930595403.9

[51] Cl. 13-03

[54] 多功能轉接器

Multi-functional adapter

[73] 廣東高普達集團股份有限公司
GUANGDONG GOPOD GROUP CO., LTD.
中國內地
廣東省深圳市龍華新區大浪街道同勝社區華榮路聯建科技工業園
廠房 8 棟 4, 5, 6 樓

[74] 中一聯合國際知識產權有限公司
香港九龍
尖沙咀漆咸道南 45-51 號
其士大廈 803 室



- [11] 1915088.3M003
[15] 26-11-2019
[30] 30-10-2019 / CN / 201930595403.9
[51] Cl. 13-03
[54] 多功能轉接器
Multi-functional adapter
[73] 廣東高普達集團股份有限公司
GUANGDONG GOPOD GROUP CO., LTD.
中國內地
廣東省深圳市龍華新區大浪街道同勝社區華榮路聯建科技工業園
廠房 8 棟 4, 5, 6 樓
[74] 中一聯合國際知識產權有限公司
香港九龍
尖沙咀漆咸道南 45-51 號
其士大廈 803 室

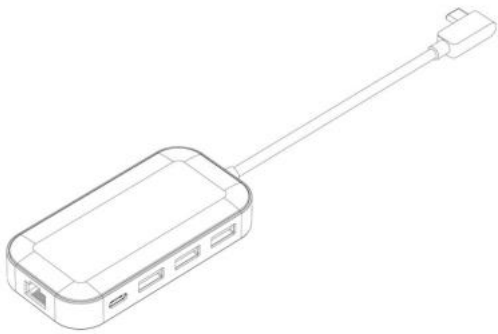

-
- [11] 1915089.5M001
[15] 26-11-2019
[30] 30-10-2019 / CN / 201930595417.0
[51] Cl. 13-02
[54] 多功能無線充電支架
Multi-functional wireless charging stand
[73] 廣東高普達集團股份有限公司
GUANGDONG GOPOD GROUP CO., LTD.
中國內地
廣東省深圳市龍華新區大浪街道同勝社區華榮路聯建科技工業園
廠房 8 棟 4, 5, 6 樓
[74] 中一聯合國際知識產權有限公司
香港九龍

尖沙咀漆咸道南 45-51 號
其士大廈 803 室



[11] 1915089.5M002

[15] 26-11-2019

[30] 30-10-2019 / CN / 201930595417.0

[51] C1. 13-02

[54] 多功能無線充電支架

Multi-functional wireless charging stand

[73] 廣東高普達集團股份有限公司

GUANGDONG GOPOD GROUP CO., LTD.

中國內地

廣東省深圳市龍華新區大浪街道同勝社區華榮路聯建科技工業園

廠房 8 棟 4, 5, 6 樓

[74] 中一聯合國際知識產權有限公司

香港九龍

尖沙咀漆咸道南 45-51 號

其士大廈 803 室



[11] 1915090.7

[15] 26-11-2019

[30] 30-10-2019 / CN / 201930595409.6

[51] Cl. 13-02

[54] 電源適配器
Power adapter

[73] 廣東高普達集團股份有限公司
GUANGDONG GOPOD GROUP CO., LTD.
中國內地
廣東省深圳市龍華新區大浪街道同勝社區華榮路聯建科技工業園
廠房 8 棟 4, 5, 6 樓

[74] 中一聯合國際知識產權有限公司
香港九龍
尖沙咀漆咸道南 45-51 號
其士大廈 803 室

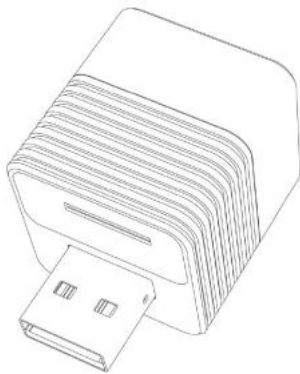

[11] 1915091.9

[15] 26-11-2019

[30] 30-10-2019 / CN / 201930594824.X

[51] Cl. 13-02

[54] 電源適配器
Power adapter

[73] 廣東高普達集團股份有限公司
GUANGDONG GOPOD GROUP CO., LTD.
中國內地
廣東省深圳市龍華新區大浪街道同勝社區華榮路聯建科技工業園
廠房 8 棟 4, 5, 6 樓

[74] 中一聯合國際知識產權有限公司
香港
香港九龍尖沙咀漆咸道南 45-51 號
其士大廈 803 室

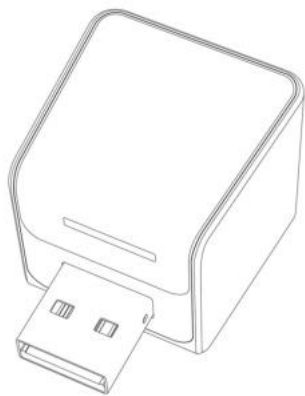

[11] 1915092.1

[15] 26-11-2019

[30] 30-10-2019 / CN / 201930594811.2

[51] C1. 13-02

[54] 電源適配器

Power adapter

[73] 廣東高普達集團股份有限公司

GUANGDONG GOPOD GROUP CO., LTD.

中國內地

廣東省深圳市龍華新區大浪街道同勝社區華榮路聯建科技工業園

廠房 8 棟 4, 5, 6 樓

[74] 中一聯合國際知識產權有限公司

香港九龍

尖沙咀漆咸道南 45-51 號

其士大廈 803 室

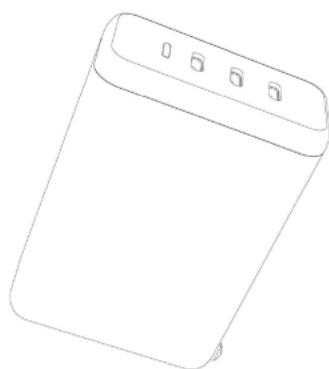

[11] 1915093.3

[15] 26-11-2019

[30] 30-10-2019 / CN / 201930594823.5

[51] Cl. 13-03

[54] 多功能轉接器

Multi-functional adapter

[73] 廣東高普達集團股份有限公司

GUANGDONG GOPOD GROUP CO., LTD.

中國內地

廣東省深圳市龍華新區大浪街道同勝社區華榮路聯建科技工業園

廠房 8 棟 4, 5, 6 樓

[74] 中一聯合國際知識產權有限公司

香港九龍

尖沙咀漆咸道南 45-51 號

其士大廈 803 室

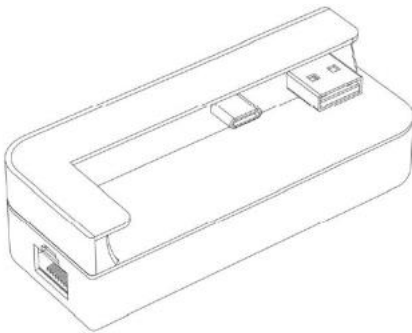

[11] 1915094.5M001

[15] 26-11-2019

[30] 31-05-2019 / US / 29/693,266

[51] Cl. 14-04

[54] 用於電子設備的圖形用戶界面

Graphical user interface for electronic device

[73] 蘋果公司

APPLE INC.

ONE APPLE PARK WAY CUPERTINO

CALIFORNIA 95014

UNITED STATES

[74] BARRON & YOUNG INTELLECTUAL PROPERTY LIMITED

Suite 617, Lakeside 2

No. 10 Science Park West Avenue, Hong Kong Science Park,

Shatin, N.T.

HONG KONG

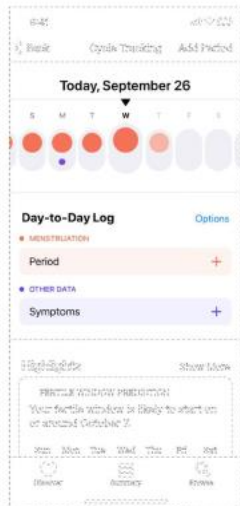

[11] 1915094.5M002

[15] 26-11-2019

[30] 31-05-2019 / US / 29/693,266

[51] Cl. 14-04

[54] 用於電子設備的圖形用戶界面

Graphical user interface for electronic device

[73] 蘋果公司

APPLE INC.

ONE APPLE PARK WAY CUPERTINO

CALIFORNIA 95014

UNITED STATES

[74] BARRON & YOUNG INTELLECTUAL PROPERTY LIMITED

Suite 617, Lakeside 2

No. 10 Science Park West Avenue, Hong Kong Science Park,
Shatin, N.T.

HONG KONG

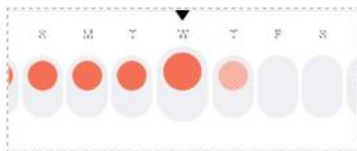

[11] 1915094.5M003

[15] 26-11-2019

[30] 31-05-2019 / US / 29/693,266

[51] Cl. 14-04

[54] 用於電子設備的圖形用戶界面
Graphical user interface for electronic device

[73] 蘋果公司
APPLE INC.
ONE APPLE PARK WAY CUPERTINO
CALIFORNIA 95014
UNITED STATES

[74] BARRON & YOUNG INTELLECTUAL PROPERTY LIMITED
Suite 617, Lakeside 2
No. 10 Science Park West Avenue, Hong Kong Science Park,
Shatin, N.T.
HONG KONG

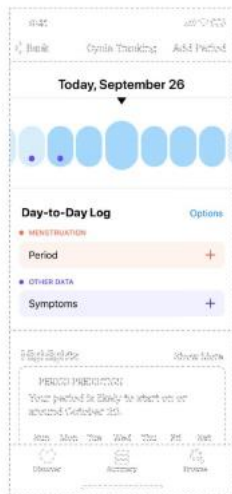

[11] 1915094.5M004

[15] 26-11-2019

[30] 31-05-2019 / US / 29/693,266

[51] Cl. 14-04

[54] 用於電子設備的圖形用戶界面
Graphical user interface for electronic device

[73] 蘋果公司
APPLE INC.
ONE APPLE PARK WAY CUPERTINO
CALIFORNIA 95014
UNITED STATES

[74] BARRON & YOUNG INTELLECTUAL PROPERTY LIMITED
Suite 617, Lakeside 2
No. 10 Science Park West Avenue, Hong Kong Science Park,
Shatin, N.T.
HONG KONG

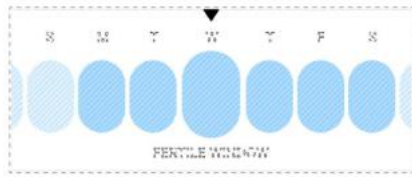

[11] 1915094.5M005

[15] 26-11-2019

[30] 31-05-2019 / US / 29/693,266

[51] Cl. 14-04

[54] 用於電子設備的圖形用戶界面
Graphical user interface for electronic device

[73] 蘋果公司
APPLE INC.
ONE APPLE PARK WAY CUPERTINO
CALIFORNIA 95014
UNITED STATES

[74] BARRON & YOUNG INTELLECTUAL PROPERTY LIMITED
Suite 617, Lakeside 2
No. 10 Science Park West Avenue, Hong Kong Science Park,
Shatin, N.T.
HONG KONG



[11] 1915094.5M006

[15] 26-11-2019

[30] 31-05-2019 / US / 29/693,266

[51] Cl. 14-04

[54] 用於電子設備的圖形用戶界面
Graphical user interface for electronic device

[73] 蘋果公司
APPLE INC.
ONE APPLE PARK WAY CUPERTINO
CALIFORNIA 95014
UNITED STATES

[74] BARRON & YOUNG INTELLECTUAL PROPERTY LIMITED
Suite 617, Lakeside 2
No. 10 Science Park West Avenue, Hong Kong Science Park,
Shatin, N.T.
HONG KONG



[11] 1915094.5M007

[15] 26-11-2019

[30] 31-05-2019 / US / 29/693,266

[51] Cl. 14-04

[54] 用於電子設備的動態圖形用戶界面
Animated graphical user interface for electronic device

[73] 蘋果公司
APPLE INC.
ONE APPLE PARK WAY CUPERTINO
CALIFORNIA 95014
UNITED STATES

[74] BARRON & YOUNG INTELLECTUAL PROPERTY LIMITED
Suite 617, Lakeside 2
No. 10 Science Park West Avenue, Hong Kong Science Park,
Shatin, N.T.
HONG KONG

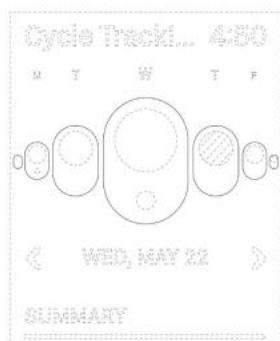

[11] 1915094.5M008

[15] 26-11-2019

[30] 31-05-2019 / US / 29/693,266

[51] Cl. 14-04

[54] 用於電子設備的圖形用戶界面

Graphical user interface for electronic device

[73] 蘋果公司

APPLE INC.

ONE APPLE PARK WAY CUPERTINO

CALIFORNIA 95014

UNITED STATES

[74] BARRON & YOUNG INTELLECTUAL PROPERTY LIMITED

Suite 617, Lakeside 2

No. 10 Science Park West Avenue, Hong Kong Science Park,
Shatin, N.T.

HONG KONG

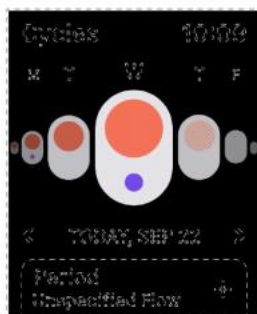

[11] 1915094.5M009

[15] 26-11-2019

[30] 31-05-2019 / US / 29/693,266

[51] Cl. 14-04

[54] 用於電子設備的圖形用戶界面

Graphical user interface for electronic device

[73] 蘋果公司

APPLE INC.

ONE APPLE PARK WAY CUPERTINO

CALIFORNIA 95014

UNITED STATES

[74] BARRON & YOUNG INTELLECTUAL PROPERTY LIMITED

Suite 617, Lakeside 2

No. 10 Science Park West Avenue, Hong Kong Science Park,
Shatin, N.T.

HONG KONG

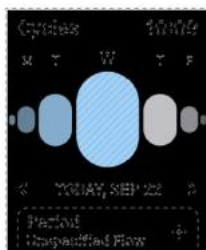

[11] 1915094.5M010

[15] 26-11-2019

[30] 31-05-2019 / US / 29/693,266

[51] Cl. 14-04

[54] 用於電子設備的圖形用戶界面

Graphical user interface for electronic device

[73] 蘋果公司

APPLE INC.

ONE APPLE PARK WAY CUPERTINO

CALIFORNIA 95014

UNITED STATES

[74] BARRON & YOUNG INTELLECTUAL PROPERTY LIMITED

Suite 617, Lakeside 2

No. 10 Science Park West Avenue, Hong Kong Science Park,

Shatin, N.T.
HONG KONG

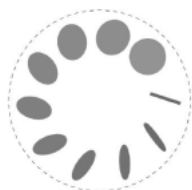

[11] 1915096.0M001

[15] 27-11-2019

[30] 28-05-2019 / MC, MA, SG, CH, TR, UA, GB, EU / DM/201917

[51] Cl. 11-01

[54] 戒指

Finger ring

[73] 查梅特國際有限公司

CHAUMET INTERNATIONAL S.A.

12 PLACE VENDÔME

75001 PARIS

FRANCE

[74] BARRON & YOUNG INTELLECTUAL PROPERTY LIMITED

Suite 617, Lakeside 2

No. 10 Science Park West Avenue, Hong Kong Science Park,
Shatin, N.T.

HONG KONG



[11] 1915096.0M002

[15] 27-11-2019

[30] 28-05-2019 / MC, MA, SG, CH, TR, UA, GB, EU / DM/201917

[51] Cl. 11-01

[54] 戒指

Finger ring

[73] 查梅特國際有限公司

CHAUMET INTERNATIONAL S.A.

12 PLACE VENDÔME

75001 PARIS

FRANCE

[74] BARRON & YOUNG INTELLECTUAL PROPERTY LIMITED

Suite 617, Lakeside 2

No. 10 Science Park West Avenue, Hong Kong Science Park,
Shatin, N.T.

HONG KONG



[11] 1915096.0M003

[15] 27-11-2019

[30] 28-05-2019 / MC, MA, SG, CH, TR, UA, GB, EU / DM/201917

[51] Cl. 11-01

[54] 戒指

Finger ring

[73] 查梅特國際有限公司

CHAUMET INTERNATIONAL S.A.

12 PLACE VENDÔME

75001 PARIS

FRANCE

[74] BARRON & YOUNG INTELLECTUAL PROPERTY LIMITED

Suite 617, Lakeside 2

No. 10 Science Park West Avenue, Hong Kong Science Park,
Shatin, N.T.

HONG KONG



[11] 1915097.2

[15] 27-11-2019

[30] 29-09-2019 / CN / 201930537171.1

[51] Cl. 14-03

[54] 手機

Mobile phone

[73] 維沃移動通信有限公司

VIVO MOBILE COMMUNICATION CO.,LTD.

中國內地

廣東省東莞市長安鎮

烏沙步步高大道 283 號

[74] 中國專利代理(香港)有限公司

香港

灣仔

港灣道 23 號鷹君中心 22 字樓



[11] 1915098.4

- [15] 27-11-2019
[51] Cl. 14-01
[54] 耳機
Headphone
[73] 鄭明勳
中國內地
吉林省延吉市
進學街嬌陽委三十三組
[74] 滙誠知識產權有限公司
香港
灣仔軒尼詩道 397 號
東區商業大廈 1206 室



-
- [11] 1915099.6
[15] 27-11-2019
[30] 27-05-2019 / FR / 2019-2447
[51] Cl. 3-01
[54] 袋
Bag
[73] LOUIS VUITTON MALLETIER
2 rue du Pont-Neuf
75001 Paris
FRANCE
[74] BAKER & MCKENZIE
14TH FLOOR, ONE TAIKOO PLACE,
979 KING'S ROAD, QUARRY BAY,
HONG KONG



[11] 1915100.0M001

[15] 27-11-2019

[30] 08-07-2019 / EU / 006617148

[51] Cl. 29-02

[54] 空氣面具

Air mask

[73] Koninklijke Philips N.V.

High Tech Campus 5,

5656 AE Eindhoven

NETHERLANDS

[74] WILKINSON & GRIST

6th Floor, Prince's Building

Chater Road

HONG KONG

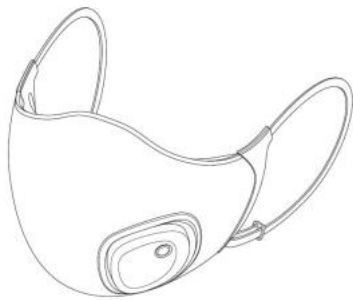

[11] 1915100.0M002

[15] 27-11-2019

[30] 08-07-2019 / EU / 006617148

[51] Cl. 29-02

[54] 空氣面具

Air mask

[73] Koninklijke Philips N.V.

High Tech Campus 5,

5656 AE Eindhoven

NETHERLANDS

[74] WILKINSON & GRIST

6th Floor, Prince's Building

Chater Road

HONG KONG

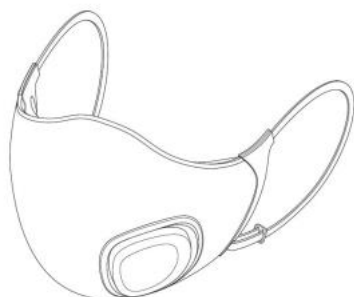

[11] 1915100.0M003

[15] 27-11-2019

[30] 08-07-2019 / EU / 006617148

[51] Cl. 29-02

[54] 空氣面具

Air mask

[73] Koninklijke Philips N.V.

High Tech Campus 5,

5656 AE Eindhoven

NETHERLANDS

[74] WILKINSON & GRIST

6th Floor, Prince's Building

Chater Road

HONG KONG

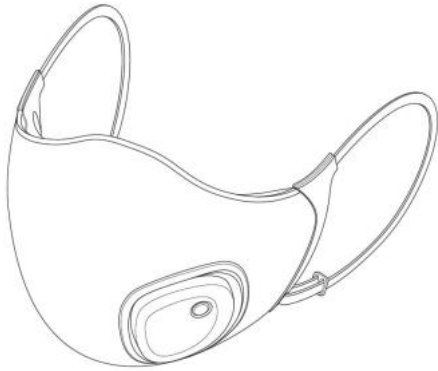

[11] 1915100.0M004

[15] 27-11-2019

[30] 08-07-2019 / EU / 006617148

[51] Cl. 29-02

[54] 空氣面具

Air mask

[73] Koninklijke Philips N.V.

High Tech Campus 5,

5656 AE Eindhoven

NETHERLANDS

[74] WILKINSON & GRIST

6th Floor, Prince's Building

Chater Road

HONG KONG

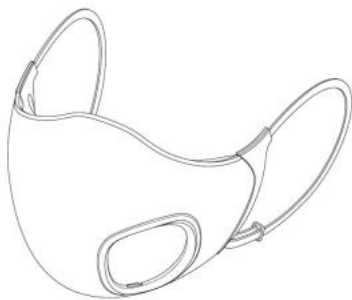

[11] 1915100.0M005

[15] 27-11-2019

[30] 08-07-2019 / EU / 006617148

[51] Cl. 29-02

[54] 空氣面具

Air mask

[73] Koninklijke Philips N.V.

High Tech Campus 5,

5656 AE Eindhoven

NETHERLANDS

[74] WILKINSON & GRIST

6th Floor, Prince's Building

Chater Road

HONG KONG

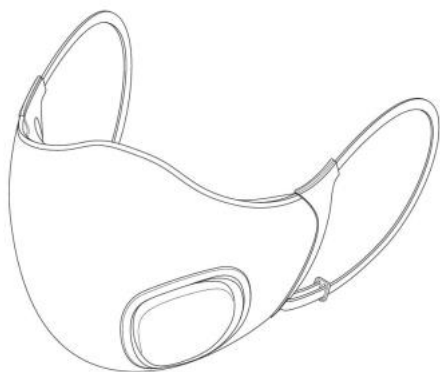

[11] 1915100.0M006

[15] 27-11-2019

[30] 08-07-2019 / EU / 006617148

[51] Cl. 29-02

[54] 空氣面具

Air mask

[73] Koninklijke Philips N.V.

High Tech Campus 5,

5656 AE Eindhoven

NETHERLANDS

[74] WILKINSON & GRIST

6th Floor, Prince's Building

Chater Road

HONG KONG

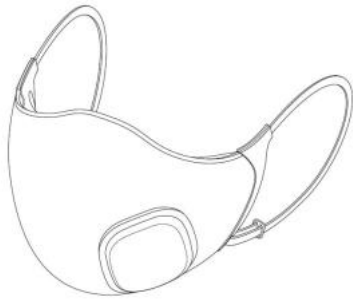

[11] 1915100.0M007

[15] 27-11-2019

[30] 08-07-2019 / EU / 006617148

[51] Cl. 29-02

[54] 空氣面具

Air mask

[73] Koninklijke Philips N.V.

High Tech Campus 5,

5656 AE Eindhoven

NETHERLANDS

[74] WILKINSON & GRIST

6th Floor, Prince's Building

Chater Road

HONG KONG

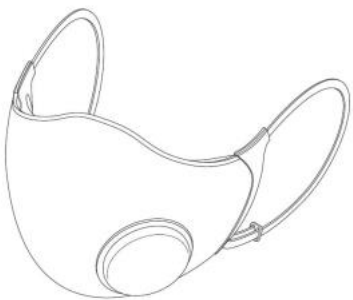

[11] 1915100.0M008

[15] 27-11-2019

[30] 08-07-2019 / EU / 006617148

[51] Cl. 29-02

[54] 空氣面具

Air mask

[73] Koninklijke Philips N.V.

High Tech Campus 5,

5656 AE Eindhoven

NETHERLANDS

[74] WILKINSON & GRIST

6th Floor, Prince's Building

Chater Road

HONG KONG



[11] 1915100.0M009

[15] 27-11-2019

[30] 08-07-2019 / EU / 006617148

[51] Cl. 29-02

[54] 用於空氣面具的風扇

Fan for air mask

[73] Koninklijke Philips N.V.

High Tech Campus 5,

5656 AE Eindhoven

NETHERLANDS

[74] WILKINSON & GRIST

6th Floor, Prince's Building

Chater Road

HONG KONG



[11] 1915100.0M010

[15] 27-11-2019

[30] 08-07-2019 / EU / 006617148

[51] Cl. 29-02

[54] 空氣面具

Air mask

[73] Koninklijke Philips N.V.

High Tech Campus 5,

5656 AE Eindhoven

NETHERLANDS

[74] WILKINSON & GRIST

6th Floor, Prince's Building

Chater Road

HONG KONG

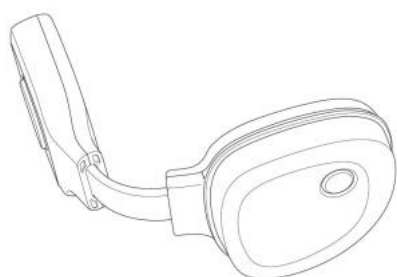

[11] 1915101.2M001

[15] 27-11-2019

[30] 29-05-2019 / US / 29/692,897

[51] Cl. 14-04

[54] 用於電子設備的圖形用戶界面
Graphical user interface for electronic device

[73] 蘋果公司
APPLE INC.
ONE APPLE PARK WAY CUPERTINO
CALIFORNIA 95014
UNITED STATES

[74] BARRON & YOUNG INTELLECTUAL PROPERTY LIMITED
Suite 617, Lakeside 2
No. 10 Science Park West Avenue, Hong Kong Science Park,
Shatin, N.T.
HONG KONG



[11] 1915101.2M002

[15] 27-11-2019

[30] 29-05-2019 / US / 29/692,897

[51] Cl. 14-04

[54] 用於電子設備的圖形用戶界面
Graphical user interface for electronic device

[73] 蘋果公司
APPLE INC.
ONE APPLE PARK WAY CUPERTINO
CALIFORNIA 95014
UNITED STATES

[74] BARRON & YOUNG INTELLECTUAL PROPERTY LIMITED
Suite 617, Lakeside 2
No. 10 Science Park West Avenue, Hong Kong Science Park,
Shatin, N.T.
HONG KONG



[11] 1915110.1M001

[15] 28-11-2019

[30] 28-05-2019 / US / 29/692,718

[51] Cl. 14-04

[54] 帶有圖形用戶界面的顯示屏或其一部分

Display screen or portion thereof with graphical user interface

[73] 蘋果公司

APPLE INC.

ONE APPLE PARK WAY

CUPERTINO, CALIFORNIA 95014

UNITED STATES

[74] CLT PATENT & TRADEMARK (H.K.) LIMITED

Unit 09, 34/F., Office Tower, Convention Plaza

No. 1 Harbour Road, Wanchai

HONG KONG



[11] 1915110.1M002

[15] 28-11-2019

[30] 28-05-2019 / US / 29/692,718

[51] Cl. 14-04

[54] 帶有圖形用戶界面的顯示屏或其一部分

Display screen or portion thereof with graphical user interface

[73] 蘋果公司

APPLE INC.

ONE APPLE PARK WAY

CUPERTINO, CALIFORNIA 95014

UNITED STATES

[74] CLT PATENT & TRADEMARK (H.K.) LIMITED

Unit 09, 34/F., Office Tower, Convention Plaza

No. 1 Harbour Road, Wanchai

HONG KONG



[11] 1915110.1M003

[15] 28-11-2019

[30] 28-05-2019 / US / 29/692,718

[51] Cl. 14-04

[54] 帶有圖形用戶界面的顯示屏或其一部分

Display screen or portion thereof with graphical user interface

[73] 蘋果公司

APPLE INC.

ONE APPLE PARK WAY

CUPERTINO, CALIFORNIA 95014

UNITED STATES

[74] CLT PATENT & TRADEMARK (H.K.) LIMITED

Unit 09, 34/F., Office Tower, Convention Plaza

No. 1 Harbour Road, Wanchai

HONG KONG



[11] 1915112.5

[15] 28-11-2019

[51] Cl. 28-03

[54] 吹風機

Hairdryer

[73] 加減零株式會社

PLUS MINUS ZERO CO.,LTD.

Kyobashi Trust Tower 8F

2-1-3 Kyobashi,Chuo-Ku,

Tokyo 104-0031

JAPAN

[74] Sunhope Intellectual Property Limited (Attn to Fiona Ko)

ROOM 902, 9/F, QUALIPAK TOWER,

NO. 121-122 CONNAUGHT ROAD WEST,

HONG KONG



[11] 1915113.7

[15] 28-11-2019

[51] Cl. 7-02

[54] 扒爐

Electric griddle

[73] 加減零株式會社

PLUS MINUS ZERO CO.,LTD.

Kyobashi Trust Tower 8F

2-1-3 Kyobashi,Chuo-Ku,

Tokyo 104-0031

JAPAN

[74] Sunhope Intellectual Property Limited (Attn: Miss Fiona Ko)
ROOM 902, 9/F, QUALIPAK TOWER,
NO. 121-122 CONNAUGHT ROAD WEST,
HONG KONG



[11] 1915115.2

[15] 28-11-2019

[51] Cl. 20-03

[54] 店舖招牌
Shop sign

[73] 金至尊國際有限公司
3D-GOLD INTERNATIONAL COMPANY LIMITED
UNITS 01-09, 17TH FLOOR,
PENINSULA SQUARE,
NO.18 SUNG ON STREET, HUNGHOM, KOWLOON, HONG KONG

[74] Legal Affairs Department
Floor 25, Metropole Square
No.2 On Yiu Street, Shatin, New Territories
HONG KONG



[11] 1915116.4

[15] 28-11-2019

[30] 31-05-2019 / JP / 011965 of 2019

[51] Cl. 12-12

[54] 嬰兒車

Baby carriage

[73] 康貝株式會社

Combi Corporation

6-7, Motoasakusa 2-chome,

Taito-ku, Tokyo 111-0041,

JAPAN

[74] WILKINSON & GRIST

6th Floor, Prince's Building

Chater Road

HONG KONG



[11] 1915117.6

[15] 28-11-2019

[30] 04-10-2019 / KR / 30-2019-0047677

[51] Cl. 8-07

[54] 手袋扣門

Bag fastener

[73] 株式會社韶熙通商

SOHHEE TRADING CO., LTD.

11, Apgujeong-ro 72-gil, Gangnam-gu, Seoul 06015,

REPUBLIC OF KOREA

[74] HASTINGS & CO

5/F Gloucester Tower, The Landmark,

11 Pedder Street, Central,

HONG KONG



[11] 1915120.2

[15] 28-11-2019

[51] Cl. 14-01

[54] 遊戲耳機

Headphone for game

[73] 鄭明勳

中國內地

吉林省延

吉市進學街嬌陽委三十三組

[74] 滙誠知識產權有限公司

香港

灣仔軒尼詩道 397 號

東區商業大廈 1206 室



[11] 1915121.4M001

[15] 29-11-2019

[30] 31-05-2019 / US / 29/693,346

[51] Cl. 14-03

Cl. 14-02

Cl. 14-01

[54] 電子裝置

Electronic device

[73] 蘋果公司

APPLE INC.

ONE APPLE PARK WAY

CUPERTINO, CALIFORNIA 95014

UNITED STATES

[74] CLT PATENT & TRADEMARK (H.K.) LIMITED

Unit 09, 34/F., Office Tower, Convention Plaza

No. 1 Harbour Road,

Wanchai, Hong Kong

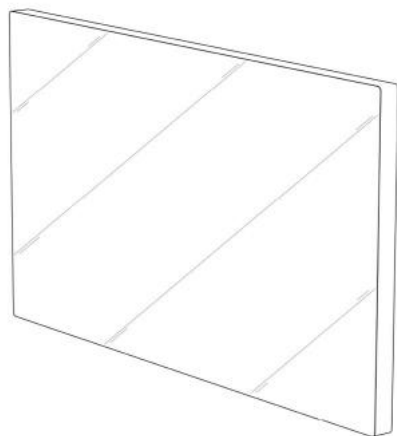

[11] 1915121.4M002

[15] 29-11-2019

[30] 31-05-2019 / US / 29/693,346

[51] Cl. 14-03

Cl. 14-02

Cl. 14-01

[54] 電子裝置

Electronic device

[73] 蘋果公司

APPLE INC.

ONE APPLE PARK WAY

CUPERTINO, CALIFORNIA 95014

UNITED STATES

[74] CLT PATENT & TRADEMARK (H.K.) LIMITED

Unit 09, 34/F., Office Tower, Convention Plaza

No. 1 Harbour Road,
Wanchai, Hong Kong

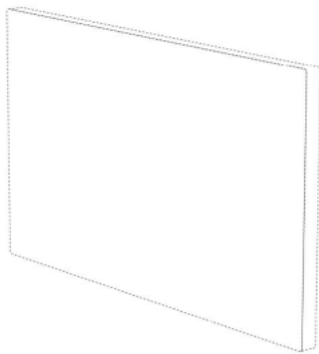

[11] 1915121.4M003

[15] 29-11-2019

[30] 31-05-2019 / US / 29/693,346

[51] Cl. 14-03

Cl. 14-02

Cl. 14-01

[54] 電子裝置

Electronic device

[73] 蘋果公司

APPLE INC.

ONE APPLE PARK WAY

CUPERTINO, CALIFORNIA 95014

UNITED STATES

[74] CLT PATENT & TRADEMARK (H.K.) LIMITED

Unit 09, 34/F., Office Tower, Convention Plaza

No. 1 Harbour Road,

Wanchai, Hong Kong

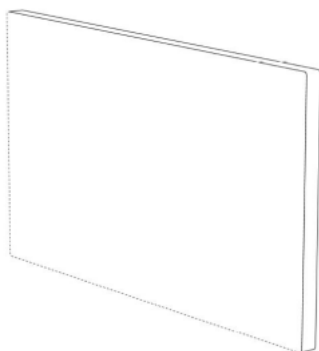

[11] 1915122.6

[15] 29-11-2019

[51] Cl. 9-03

[54] 包裝用盒

Packaging box

[73] KRACIE HOME PRODUCTS, LTD.

20-20, Kaigan 3-chome, Minato-ku, Tokyo 108-0022

JAPAN

[74] Union Patent Service Centre

Units E-F, 20th Floor, Neich Tower,

128 Gloucester Road,

Hong Kong



[11] 1915123.8

[15] 29-11-2019

[51] Cl. 9-01

[54] 包裝用容器

Packaging container

[73] KRACIE HOME PRODUCTS, LTD.

20-20, Kaigan 3-chome, Minato-ku, Tokyo 108-0022

JAPAN

[74] Union Patent Service Centre

Units E-F, 20th Floor, Neich Tower,

128 Gloucester Road,

Hong Kong



[11] 1915124.0

[15] 29-11-2019

[51] Cl. 9-03

[54] 包裝用盒

Packaging box

[73] KRACIE HOME PRODUCTS, LTD.

20-20, Kaigan 3-chome, Minato-ku, Tokyo 108-0022

JAPAN

[74] Union Patent Service Centre

Units E-F, 20th Floor, Neich Tower,

128 Gloucester Road,

Hong Kong



[11] 1915125.3

[15] 29-11-2019

[51] Cl. 9-01

[54] 包裝用容器

Packaging container

- [73] KRACIE HOME PRODUCTS, LTD.
20-20, Kaigan 3-chome, Minato-ku, Tokyo 108-0022
JAPAN
- [74] Union Patent Service Centre
Units E-F, 20th Floor, Neich Tower,
128 Gloucester Road,
Hong Kong



-
- [11] 1915126.5
- [15] 29-11-2019
- [30] 04-06-2019 / CN / 201930286816.9
- [51] Cl. 10-01
- [54] 帶有圖形用戶界面的智能鬧鐘
Intelligent alarm clock with graphical user interface
- [73] 北京小米移動軟體有限公司
Beijing Xiaomi Mobile Software Co., Ltd.
No.018, Floor 8, Building 6, Yard 33,
Middle Xierqi Road, Haidian District, Beijing 100085
- [74] China Patent Agent (Hong Kong) Limited
22/F, Great Eagle Centre, 23 Harbour Road,
Wanchai, Hong Kong

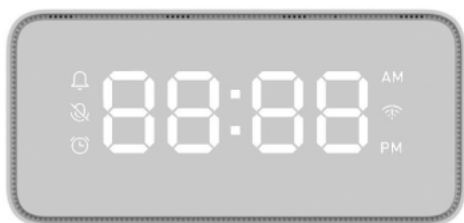

-
- [11] 1915127.7

[15] 29-11-2019

[51] Cl. 9-03

[54] 包裝用盒

Packaging box

[73] KRACIE HOME PRODUCTS, LTD.

20-20, Kaigan 3-chome, Minato-ku, Tokyo 108-0022

JAPAN

[74] Union Patent Service Centre

Units E-F, 20th Floor, Neich Tower,

128 Gloucester Road,

HONG KONG



[11] 1915128.9

[15] 29-11-2019

[51] Cl. 9-03

[54] 包裝用盒

Packaging box

[73] KRACIE HOME PRODUCTS, LTD.

20-20, Kaigan 3-chome, Minato-ku, Tokyo 108-0022

JAPAN

[74] Union Patent Service Centre

Units E-F, 20th Floor, Neich Tower,

128 Gloucester Road,

Hong Kong



[11] 1915129.1

[15] 29-11-2019

[51] Cl. 9-01

[54] 包装用容器

Packaging container

[73] KRACIE HOME PRODUCTS, LTD.

20-20, Kaigan 3-chome, Minato-ku, Tokyo 108-0022
JAPAN

[74] UNION PATENT SERVICE CENTRE

Units E-F, 20th Floor, Neich Tower,
128 Gloucester Road,
HONG KONG





香港特別行政區政府知識產權署外觀設計註冊處

The Government of the Hong Kong Special Administrative Region

Designs Registry, Intellectual Property Department

根據註冊外觀設計條例第 28 條，下列註冊外觀設計因未繳續期費而停止有效。

各組記項按註冊外觀設計停止有效日期及註冊編號先後次序排列。

Registered designs ceased through non-payment of renewal fees under section 28 of the Registered Designs Ordinance. Entries are listed below under their expiry dates.

11-03-2020 - 17-03-2020

11-03-2020	0500522.2M014	1000456.8M024
1500646.7M001	0500522.2M015	1000456.8M025
1500646.7M002	0500522.2M016	1000456.8M033
1500648.1	0500531.1	1000456.8M034
1500649.3M001	1500663.2	1000456.8M035
1500649.3M004	1500664.4	1000456.8M036
1500649.3M005		1000461.8M001
1500649.3M006		1000461.8M002

14-03-2020

	0500534.7M006	1000461.8M003
12-03-2020	0500534.7M010	1000464.4
1500650.5	0500535.0M021	1000465.7
1500651.7M001	0500535.0M022	1000467.1
1500651.7M002	0500535.0M023	1000468.3
1500652.9	0500535.0M040	1000469.5
1500655.6	0500535.0M041	1500665.7
1500659.4	0500535.0M042	1500666.9
1500660.6	0500535.0M043	1500667.1
1500661.8	0500544.8M001	1500668.3
1500662.0	1000449.3M001	1500669.5
	1000449.3M002	1500670.7

13-03-2020

	1000450.5M001	1500671.9
0500522.2M001	1000450.5M002	1500672.1
0500522.2M002	1000450.5M003	1500675.8
0500522.2M003	1000450.5M004	1500678.4
0500522.2M004	1000450.5M005	1500682.2
0500522.2M005	1000450.5M007	
0500522.2M006	1000450.5M009	
0500522.2M007	1000450.5M011	

16-03-2020

		0500555.2
		1000482.2M001
		1000482.2M002
		1500688.5
		1500689.7
		1500691.1
		1500693.5M001

15-03-2020

	1000456.8M016	
	1000456.8M017	
	1000456.8M022	
	1000456.8M023	

1500693.5M002

17-03-2020

0500565.3M001

0500565.3M002

0500565.3M003

0500565.3M004

1000486.1

1000487.3

1500697.4

1500698.6

1500700.2M001

1500700.2M002

1500700.2M003

1500700.2M004

1500701.4M001

1500701.4M002

1500701.4M003

1500701.4M004

1500702.6M001

1500702.6M002

1500702.6M003

1500702.6M004



香港特別行政區政府知識產權署外觀設計註冊處

The Government of the Hong Kong Special Administrative Region

Designs Registry, Intellectual Property Department

根據註冊外觀設計條例第 30 條放棄的外觀設計的註冊

Surrender of registration of design under section 30 of the Registered Designs Ordinance

[11] 1913170.5

[73] 黎錦河 LAI KAM HO



香港特別行政區政府知識產權署外觀設計註冊處

The Government of the Hong Kong Special Administrative Region

Designs Registry, Intellectual Property Department

根據註冊外觀設計規則第 31 條刪除的註冊外觀設計。各組記項按註冊外觀設計刪除日期及註冊編號先後次序排列。

Registered designs removed under section 31 of the Registered Designs Rules. Entries are listed below under their removal dates.

09-04-2020 - 15-04-2020

09-04-2020

1401695.0

1401696.2

1401699.8

15-04-2020

1401718.0

1401724.2

9911245.0

12-04-2020

1401701.4

1401702.6

1401703.8M001

1401703.8M002

1401704.0

13-04-2020

0412109.9

0412110.1M001

0412110.1M002

0412111.3

0901509.0M001

0901509.0M002

0901509.0M003

1401707.7M001

1401707.7M002

14-04-2020

0412130.3

0412131.5

0901516.5

0901517.7M001

1401713.9

1401714.1M001

1401715.4M001

1401716.6M001

1401716.6M002

1401716.6M004