



香港特別行政區政府知識產權署商標註冊處
Trade Marks Registry, Intellectual Property Department
The Government of the Hong Kong Special Administrative Region

接納註冊 (全文本)

商標註冊處處長已根據《商標條例》(第 559 章)第 42 條, 接納下列商標的註冊申請。現根據《商標條例》第 43 條及《商標規則》(第 559 章附屬法例)第 15 條, 公布申請的詳情。

根據《商標條例》第 44 條及《商標規則》第 16 條, 任何人擬就下列商標的註冊提出反對, 須在本公告公布日期起計的三個月內, 採用表格第 T6 號提交反對通知。(例如, 若果公布日期為 2003 年 4 月 4 日, 則該三個月的後一日為 2003 年 7 月 3 日。)反對通知須載有反對理由的陳述及《商標規則》第 16(2)條所提述的事宜。反對人須在提交反對通知的同時, 將該通知的副本送交有關申請人。

有關商標註冊處處長根據商標條例(第 43 章)第 13 條/商標條例(第 559 章)附表 5 第 10 條所接納的註冊申請, 請到 <http://www.gld.gov.hk/cgi-bin/gld/egazette/index.cgi?lang=c&agree=0> 檢視電子憲報。

ACCEPTANCE FOR REGISTRATION (FULL VERSION)

The Registrar of Trade Marks has accepted the following trade marks for registration under section 42 of the Trade Marks Ordinance (Cap. 559). Under section 43 of the Trade Marks Ordinance and rule 15 of the Trade Marks Rules (Cap. 559 sub. leg.), the particulars of the applications are published.

Under section 44 of the Trade Marks Ordinance and rule 16 of the Trade Marks Rules, any person who wishes to oppose the registration of any of these marks shall, within the 3-month period beginning on the date of this publication, file a notice of opposition on Form T6. (For example, if the publication date is 4 April 2003, the last day of the 3-month period is 3 July 2003.) The notice of opposition shall include a statement of the grounds of opposition and the matters referred to in rule 16(2). The opponent shall, at the same time as he files the notice of opposition, send a copy of it to the applicant of the application in question.

For applications for registration accepted by the Registrar of Trade Marks under section 13 of the Trade Marks Ordinance (Cap. 43)/section 10 of Schedule 5 to the Trade Marks Ordinance (Cap. 559), please view e-gazette at <http://www.gld.gov.hk/cgi-bin/gld/egazette/index.cgi?lang=c&agree=0>.

類別 Class 11

[210] 商標申請編號: 305439619
Application No.:

[540] 商標 :
Mark:



[550] 商標種類 : Ordinary
Mark Type:
一系列商標 : NO
Series Mark:

[571] 商標描述 : N/A
Mark Description:

[730] 註冊申請人的姓名 / 名稱、地址 : POSITEC GROUP LIMITED
Applicant(s) ' LEVEL 54, HOPEWELL CENTRE,
Name, Address: 183 QUEEN'S ROAD EAST,
HONG KONG

[740/ 註冊申請人的送達地址 : CHINA HONGKONG IP LIMITED
750] Applicant's Address for 1502, 15/F, Capital Centre, 151 Gloucester
Service: Road, Wanchai
HONG KONG

[511] 類別編號 : 7, 9, 11, 12
Class(es) No(s) .:

[511] 貨品 / 服務說明 : Class 11:
Specification: Apparatus for lighting; lights, light bulbs;
emergency lights; garden lights; electrical
heating apparatus; heat guns; steam generating
installations; fabric steamers; electric
steamers for cooking; apparatus and
installations for cooking; microwave ovens
[cooking apparatus]; cooking utensils,
electric; autoclaves, electric, for cooking;
pressure cookers, electric; kettles, electric;
coffee machines, electric; grills [cooking
appliances]; roasting apparatus; refrigerating
appliances and installations; refrigerators;
refrigerating containers; refrigerating
cabinets; ice chests; Ice boxes; electrically
ice boxes; drying apparatus and installations;
electric drying apparatus; ventilation [air-
conditioning] installations and apparatus;
electric ventilation fans; electric blowers
for ventilation; air conditioning fans; air
fans; electric fans; ventilating fans; water
supply installations; automatic watering
installations; automatic watering
installations for plants; sprinkler apparatus
[automatic] for horticultural irrigation;
sprinkler apparatus [automatic] for
agricultural irrigation; sanitary apparatus
and installations; tanning apparatus [sun
beds]; disinfectant apparatus; air purifiers;
air purifying apparatus and machines; air

filtering installations; filters for air conditioning; apparatus for water purification; water filtering apparatus; filters for drinking water; electrically heated clothing; electrically heated carpets; socks, electrically heated; electrically heated foot muffs; filters for use with apparatus for ventilating; electrical fans being parts of household ventilation installations; drip irrigation emitters [irrigation fittings]; parts, fittings and accessories in this class for the aforesaid goods all included in class 11.

- [526] 卸棄 : N/A
Disclaimer:
- [529] 限制 : N/A
Limitation:
- [527] 條件 : N/A
Condition:
其他 : By consent, No. 302279322
Others
- [220] 提交日期 : 06-11-2020
Date of Filing:
- [320] 聲稱具有優先權的日期 : N/A
Date of Priority Claimed:
- [310] 優先權申請編號 : N/A
Priority Application Number:
- [340] 聲稱具有優先權 (部分) : N/A
Priority Claim Details:
- [330] 優先權申請的
國家、地區、地方 : N/A
Country, territory, area of
Priority Applications:
-
-

- [210] 商標申請編號 : 305581198AA
Application No.:
- [540] 商標 :
Mark:

Emma

- [550] 商標種類 : Ordinary
Mark Type:
一系列商標 : NO
Series Mark:

- [571] 商標描述 : N/A
Mark Description:
- [730] 註冊申請人的姓名 / 名稱、地址 : Emma Matratzen GmbH
Applicant(s) ' Wilhelm-Leuschner-Str. 78
Name, Address: 60329 Frankfurt am Main
GERMANY
- [740/ 註冊申請人的送達地址 : BKIP Limited
750] Applicant's Address for Unit 2202, 22/F, Causeway Bay Plaza I,
Service: 489 Hennessy Road, Causeway Bay,
Hong Kong
- [511] 類別編號 : 11, 20, 24
Class(es) No(s) .:
- [511] 貨品 / 服務說明 : Class 11:
Specification: Electric lamps; electric lighting fixtures;
night-lights; humidifiers; apparatus and
installations for lighting, heating, cooling,
steam generating, cooking, drying,
ventilating, water supply and sanitary
purposes.
Class 20:
Pillows; bed mattresses; bed bases; bedding
for beds.
Class 24:
Bed coverings; blanket covers; duvets; cushion
covers; pillow covers; mattress covers;
textile goods for use as bedding; bed blankets
- [526] 卸棄 : N/A
Disclaimer:
- [529] 限制 : N/A
Limitation:
- [527] 條件 : N/A
Condition:
其他 : N/A
Others
- [220] 提交日期 : 31-03-2021
Date of Filing:
- [320] 聲稱具有優先權的日期 : N/A
Date of Priority Claimed:
- [310] 優先權申請編號 : N/A
Priority Application Number:
- [340] 聲稱具有優先權 (部分) : N/A
Priority Claim Details:
- [330] 優先權申請的 N/A
國家、地區、地方 :
Country, territory, area of
Priority Applications:
-
-
- [210] 商標申請編號 : 305581206AA
Application No.:

[540] 商標 : A
Mark:



B



[550] 商標種類 : Ordinary
Mark Type:
一系列商標 : YES
Series Mark:

[571] 商標描述 : The applicant claims the colour blue as an element of mark "B" in the series.
Mark Description:

[730] 註冊申請人的姓名 / 名稱、地址 : Emma Matratzen GmbH
Applicant(s) ' Wilhelm-Leuschner-Str. 78
Name, Address: 60329 Frankfurt am Main
GERMANY

[740/ 註冊申請人的送達地址 : BKIP Limited
750] Applicant's Address for Unit 2202, 22/F, Causeway Bay Plaza I,
Service: 489 Hennessy Road, Causeway Bay,
Hong Kong

[511] 類別編號 : 11
Class(es) No(s) .:

[511] 貨品 / 服務說明 : Class 11:
Specification: Electric lamps; electric lighting fixtures;
night-lights; humidifiers; apparatus and
installations for lighting, heating, cooling,
steam generating, cooking, drying,
ventilating, water supply and sanitary
purposes.

[526] 卸棄 : N/A
Disclaimer:

[529] 限制 : N/A
Limitation:

[527] 條件 : N/A
Condition:
其他 : N/A
Others

[220] 提交日期 : 31-03-2021
Date of Filing:

[320] 聲稱具有優先權的日期 : N/A
Date of Priority Claimed:

[310] 優先權申請編號 : N/A
Priority Application Number:

[340] 聲稱具有優先權 (部分) : N/A
Priority Claim Details:

[330] 優先權申請的
國家、地區、地方 : N/A
Country, territory, area of
Priority Applications:

[210] 商標申請編號 : 305581224AA
Application No.:

[540] 商標 :
Mark:

A



B



[550] 商標種類 : Ordinary
Mark Type:

一系列商標 : YES
Series Mark:

[571] 商標描述 : The applicant claims the colour blue as an
Mark Description: element of mark "B" in the series.

[730] 註冊申請人的姓名 / 名稱、地址 : Emma Matratzen GmbH
Applicant(s) ' Wilhelm-Leuschner-Str. 78
Name, Address: 60329 Frankfurt am Main
GERMANY

[740/ 註冊申請人的送達地址 : BKIP Limited
750] Applicant's Address for Unit 2202, 22/F, Causeway Bay Plaza I,
Service: 489 Hennessy Road, Causeway Bay,
Hong Kong

[511] 類別編號 : 11, 20, 24

Class(es) No(s) .:

[511] 貨品 / 服務說明 : Class 11:
Specification: Electric lamps; electric lighting fixtures;
night-lights; humidifiers; apparatus and
installations for lighting, heating, cooling,
steam generating, cooking, drying,

ventilating, water supply and sanitary purposes.

Class 20:

Pillows; bed mattresses; bed bases; bedding for beds.

Class 24:

Bed coverings; blanket covers; duvets; cushion covers; pillow covers; mattress covers; textile goods for use as bedding; bed blankets

N/A

[526] 卸棄:

Disclaimer:

[529] 限制:

Limitation:

[527] 條件:

Condition:

其他:

Others

[220] 提交日期:

Date of Filing:

[320] 聲稱具有優先權的日期:

Date of Priority Claimed:

[310] 優先權申請編號:

Priority Application Number:

[340] 聲稱具有優先權 (部分):

Priority Claim Details:

[330] 優先權申請的

國家、地區、地方:

Country, territory, area of

Priority Applications:

N/A

N/A

N/A

31-03-2021

N/A

N/A

N/A

N/A

[210] 商標申請編號:

Application No.:

305581404

[540] 商標:

Mark:



[550] 商標種類:

Mark Type:

Ordinary

一系列商標 :	NO
Series Mark:	
[571] 商標描述 :	The applicant claims the colours pink and orange as elements of the trade mark.
Mark Description:	
[730] 註冊申請人的姓名 / 名稱、地址 :	Reckitt & Colman (Overseas) Health Limited
Applicant(s) ' Name, Address:	103-105 Bath Road, Slough, Berkshire, SL1 3UH, UNITED KINGDOM
[740/ 註冊申請人的送達地址 :	DEACONS
750] Applicant's Address for Service:	5th Floor, Alexandra House Central HONG KONG
[511] 類別編號 :	3, 5, 8, 9, 10, 11, 21, 29, 35, 41, 44
Class(es) No(s) .:	
[511] 貨品 / 服務說明 :	Class 11:
Specification:	Apparatus and installations for lighting, heating, cooling, steam generating, cooking, drying, ventilating, water supply and sanitary purposes; disinfection apparatus; apparatus for disinfecting water; apparatus for decalcifying water; air freshener dispensing systems; air freshener plug-ins; air deodorising apparatus; air purifying apparatus; water softeners; apparatus and instruments, all for scenting, purifying or freshening the atmosphere; dehumidifying apparatus; electrical powered air purifiers for the neutralization, reduction or control of allergens; parts and fittings for all the aforesaid goods; deodorising apparatus.
[526] 卸棄 :	N/A
Disclaimer:	
[529] 限制 :	N/A
Limitation:	
[527] 條件 :	N/A
Condition:	
其他 :	N/A
Others	
[220] 提交日期 :	31-03-2021
Date of Filing:	
[320] 聲稱具有優先權的日期 :	22-10-2020
Date of Priority Claimed:	
[310] 優先權申請編號 :	81785
Priority Application Number:	
[340] 聲稱具有優先權 (部分) :	N/A
Priority Claim Details:	
[330] 優先權申請的國家、地區、地方 :	JAMAICA
Country, territory, area of Priority Applications:	

[210] 商標申請編號 : 305670504
Application No.:

[540] 商標 :
Mark:

YETI

[550] 商標種類 : Ordinary

Mark Type:

一系列商標 : NO

Series Mark:

[571] 商標描述 : N/A

Mark Description:

[730] 註冊申請人的姓名 / 名稱、地址 :

Applicant(s)'

Name, Address:

YETI Coolers, LLC

7601 Southwest Pkwy

Austin, Texas 78735,

UNITED STATES OF AMERICA

[740/ 註冊申請人的送達地址 :

750] Applicant's Address for

Service:

WISELY & MANSION INTELLECTUAL PROPERTY (HONG
KONG) LIMITED

Unit 12, 21/F., Wayson Commercial Building,

No. 28, Connaught Road West, Sheung Wan,

HONG KONG

[511] 類別編號 : 11, 21

Class(es) No(s) .:

[511] 貨品 / 服務說明 :

Specification:

Class 11:

insulated water dispensers; portable beverage dispensers; water dispensers; structural parts and fittings for the aforesaid goods; accessories for the aforesaid goods.

Class 21:

drinkware; beverage ware; drinking glasses, namely, tumblers; cups; mugs; coffee mugs; coffee cups; coffee cups, tea cups and mugs; cocktail glasses; small jugs; beer mugs; beer jugs; drinking bottles for sports; jugs; wine glasses; vacuum bottles; cup lids; double wall cups; drinking glasses; drinking vessels; tumblers for use as drinking glasses; travel mugs; insulated mugs; beer glasses; straws for drinking; drinking cups for babies and children; bottles, sold empty; sports bottles sold empty; reusable water bottles sold empty; reusable stainless steel water bottles sold empty; drinking cups sold with lids therefor; lids with drinking spouts for reusable water bottles; double wall cups with lids and straws; double wall cups with lids; water bottles sold empty; whisky glasses; heat-insulated vessels; drinking straws; portable beverage container holder; sippy cups;

drinking cups for babies and children and parts and fittings therefor, namely, cups for babies and children sold as a unit with valves and lids; drinking cups for infants and parts and fittings therefor, namely, valves and lids sold as a unit; drinking cups for children and parts and fittings therefor, namely, drinking cups for children sold as a unit with non-insulated lids; drinking straws for babies and children; handles specially adapted for beverage ware; vacuum container for hot or cold food and drink; insulated drinkware; insulated beverage ware; temperature retaining vessels; insulating sleeve holders for bottles; insulating sleeve holders for beverage cans; thermal insulated wrap for cans to keep the contents cold or hot; insulating sleeve holders for jars, bottles or cans; insulating sleeve holders made of stainless steel for jars, bottles or cans; insulating sleeve holder for beverage cups; stainless steel drink holders; stainless steel can and bottle holders; bottle openers, non-electric; non-electric bottle openers; bottle openers; cold packs for chilling food and beverages; cold packs used to keep food and drink cold; pet feeding dishes; feeding vessels for pets; pet feeding and drinking bowls; pet dishes; pet water bowls; pet bowls; pet drinking bowls; plastic buckets; rinsing pails; buckets; ice pails; rinsing buckets; pails; tool bucket organizer, namely, an organizer specially adapted for affixation to a bucket for holding tools and other apparatus; fitted covers for buckets or pails; non-electric portable coldboxes; non-electric portable coolers; non-electric portable cooler bags; non-electric portable cooler backpacks; insulated containers for food or beverages; heat-insulated containers for beverages; insulated containers for food or beverage for domestic use; thermal insulated containers for food or beverages; insulated lunch boxes; insulated lunch bags; ice buckets; thermal insulated bags for food or beverages; insulated bags for food or beverage for domestic use; portable ice chests for food and beverages; heat-insulated containers for household use; containers for ice; non-electric portable beverage coolers; portable cool boxes, non-electric; thermally insulated containers for food; insulated carriers for food and beverages; portable non-electric water coolers; lunchboxes; lunch bags not of paper; general purpose storage bins for household use; household containers for foods; lunch

pails; plastic storage containers for household use; containers for kitchen use; kitchen containers; portable plastic containers for storing household and kitchen goods; all purpose portable household containers; containers for household use; non-modular containers for use in transportation and storage for household use; plastic storage containers for domestic use; non-electric kitchen containers not made of precious metal; lockable non-metal household containers for food; drain stoppers for drains; pouring spouts for household use; trays for household purposes; metal baskets for household purposes; baskets for household purposes; baskets of metal for household purposes; interior trays for non-electric portable coolers; interior organizers for non-electric portable coolers; interior caddies for non-electric portable coolers; interior dividers for non-electric portable coolers; interior caddies for buckets; interior trays for buckets; bucket organizer, namely, an organizer specially adapted for affixation to a bucket for holding tools and other apparatus; sleeve holder for bottles, namely, bottle carriers for domestic use; neoprene bottle holders, namely, bottle carriers for domestic use; slings specially adapted for holding bottles; bag specially adapted for holding bottles; sleeve holder for bottles; structural parts and fittings for the aforesaid goods; accessories for the aforesaid goods.

- [526] 卸棄 : N/A
Disclaimer:
- [529] 限制 : N/A
Limitation:
- [527] 條件 : N/A
Condition:
其他 : N/A
Others
- [220] 提交日期 : 28-06-2021
Date of Filing:
- [320] 聲稱具有優先權的日期 : N/A
Date of Priority Claimed:
- [310] 優先權申請編號 : N/A
Priority Application Number:
- [340] 聲稱具有優先權 (部分) : N/A
Priority Claim Details:
- [330] 優先權申請的
國家、地區、地方 : N/A
Country, territory, area of
Priority Applications:

[210] 商標申請編號 : 305708377
Application No.:

[540] 商標 :
Mark: **S P I C A R E V 3**

[550] 商標種類 : Ordinary
Mark Type:
一系列商標 : NO
Series Mark:

[571] 商標描述 : N/A
Mark Description:

[730] 註冊申請人的姓名 / 名稱、地址 : CHARIS & Co., Ltd.
Applicant(s) ' 19th Floor HIBIYA PARKFRONT, 2-1-6 Uchisaiwai-
Name, Address: cho, Chiyoda-ku, Tokyo,
JAPAN

[740/ 註冊申請人的送達地址 : UNION PATENT SERVICE CENTRE
750] Applicant's Address for Units E-F, 20th Floor, Neich Tower,
Service: 128 Gloucester Road,
HONG KONG

[511] 類別編號 : 3,10,11
Class(es) No(s).:

[511] 貨品 / 服務說明 : Class 11:
Specification: Household electrothermic apparatus for beauty
or sanitary purposes; electric facial
equipment for household purposes.

[526] 卸棄 : N/A
Disclaimer:

[529] 限制 : N/A
Limitation:

[527] 條件 : N/A
Condition:
其他 : N/A
Others

[220] 提交日期 : 04-08-2021
Date of Filing:

[320] 聲稱具有優先權的日期 : 12-02-2021
Date of Priority Claimed:

[310] 優先權申請編號 : 2021-016570
Priority Application Number:

[340] 聲稱具有優先權 (部分) : for goods listed in Classes 3 and 11 and goods
Priority Claim Details: listed in (A) in Class 10

[330] 優先權申請的 JAPAN
國家、地區、地方 :
Country, territory, area of
Priority Applications:

[210]	商標申請編號 : Application No.:	305709556
[540]	商標 : Mark:	
[550]	商標種類 : Mark Type:	Ordinary
	一系列商標 : Series Mark:	NO
[571]	商標描述 : Mark Description:	N/A
[730]	註冊申請人的姓名 / 名稱、地址 : Applicant(s) ' Name, Address:	PT. BAGUS INTIKARYA PROPERTI The Koppel Building Suite 6; Jl. Pluit Selatan Raya No. 10; Kel. Pluit Kec. Penjaringan Jakarta Utara 14450 INDONESIA
[740/ 750]	註冊申請人的送達地址 : Applicant's Address for Service:	CHINAHONGKONG IP LIMITED 1502, 15/F, Capital Centre, 151 Gloucester Road, Wanchai HONG KONG
[511]	類別編號 : Class(es) No(s) .:	2, 4, 6, 7, 9, 11, 22, 25, 26
[511]	貨品 / 服務說明 : Specification:	Class 11: Lights for vehicles; germicidal lamps for purifying air; curling lamps; oil lamps; hair dryers; fireplaces; ornamental fountains; lighters.
[526]	卸棄 : Disclaimer:	N/A
[529]	限制 : Limitation:	N/A
[527]	條件 : Condition:	N/A
	其他 : Others	N/A
[220]	提交日期 : Date of Filing:	05-08-2021
[320]	聲稱具有優先權的日期 : Date of Priority Claimed:	N/A
[310]	優先權申請編號 : Priority Application Number:	N/A
[340]	聲稱具有優先權 (部分) :	N/A

Priority Claim Details:

[330] 優先權申請的 N/A
國家、地區、地方：
Country, territory, area of
Priority Applications:

[210] 商標申請編號： 305718006
Application No.:

[540] 商標：
Mark:

BORA

[550] 商標種類： Ordinary
Mark Type:
一系列商標： NO
Series Mark:

[571] 商標描述： N/A
Mark Description:

[730] 註冊申請人的姓名 / 名稱、地址： BORA - Vertriebs GmbH & Co KG
Applicant(s) ' Innstraße 1,
Name, Address: 6342 NIEDERNDORF,
AUSTRIA

[740/ 註冊申請人的送達地址： MARKS & CLERK
750] Applicant's Address for Level 9, Cyberport 1
Service: 100 Cyberport Road, Pok Fu Lam
HONG KONG

[511] 類別編號： 11
Class(es) No(s) .:

[511] 貨品 / 服務說明： Class 11:
Specification: Lighting apparatus; heating apparatus; steam
generating apparatus; cooking appliances;
refrigerating apparatus; drying installations;
apparatus for ventilating and water supply as
well as sanitary installations; sinks;
extractors for kitchens, in particular
downdraft extractors and downdraft work
surface extraction devices; ventilation
devices; hearths; cooking hobs; cooking rings;
air filtering installations; steam extractors;
fans for exhaust extractors; filters for steam
extractors; filters for air conditioning;
extractors [ventilation or air conditioning];
filters [parts of household or industrial
installations]; extractor hoods for kitchens;
downdraft cooking hob extracting
installations; downdraft work surface

extracting installations; electric heaters for feeding bottles; bakers' ovens; lava stones for barbecue grills; barbecues; wash-hand basins [parts of sanitary installations]; lighting apparatus and installations; lighting lamps; ventilation hoods; ventilation hoods for laboratories; structural plates for ovens; bread baking machines, bread toasters; electric pressure cookers (autoclaves); steam generating installations; steam boilers, other than parts of machines; steam accumulators; ceiling lights; apparatus for dehydrating food waste; disinfectant apparatus; disinfectant dispensers for kitchens; air deodorizing apparatus; deodorizing apparatus (not for personal use); fruit roasters; roasting jacks; ice machines and apparatus; cool boxes, electric; air reheaters; sockets for electric lights; water filtering apparatus; electric deep fryers; gas burners; deep freezing apparatus; chest freezers; beverage cooling apparatus; roasting apparatus; rotisseries; roasting spits; taps for pipes and pipelines; hand drying apparatus for washrooms; hot air apparatus; hot air bath fittings; water heaters; electric heating apparatus; heating plates; hearths, microwave ovens for industrial purposes; electric appliances for making yoghurt; electric coffee filters; electric coffee machines; electric coffee percolators; coffee roasters; coffee roasting machines; air-conditioning installations; air conditioners for vehicles; air-conditioning apparatus; cooking apparatus and installations; kilns; electric cooking utensils; kitchen ranges [ovens]; cooling installations for liquids; cooling installations and machines; cooling installations for water; air cooling apparatus; refrigerators; refrigerated showcases; germicidal lamps for purifying air; pipes [parts of sanitary installations]; water conduits installations; light diffusers; electric fans for personal use; air purifying apparatus and machines; air sterilizers; ventilation [air-conditioning] installations and apparatus; microwave ovens [cooking apparatus]; mixer taps for water pipes; anti-splash tap nozzles; furnace grates; pasteurisers; hot plates; heat pumps; fumigation apparatus, not for medical purposes; chimney flues; stoves; regulating and safety accessories for gas apparatus and water apparatus, as well as for water pipes or gas pipes; air dryers; water purification installations; sanitary apparatus and

installations; coil pipes (parts of heating or cooling installations); electric pressure cooking saucepans; heat accumulators; sterilizers; immersion heaters; plate warmers; refrigerating appliances and installations; electric toasters; filters for drinking water; desiccating apparatus; ultraviolet ray lamps, not for medical purposes; fans [air-conditioning]; fans [parts of air-conditioning installations]; electric waffle irons; heat regenerators; heat exchangers, other than parts of machines; electric laundry dryers; water softening apparatus and installations; water supply installations; water distribution installations; hot air ovens; fireplaces; coils [parts of distilling, heating or cooling installations]; range hoods; exhaust hoods [cooker hoods]; filters for air extractor hoods; adjustable coated baffle grease filters [parts of cooker hoods]; electric kettles; all aforesaid goods not for motorized land vehicles.

- [526] 卸棄 : N/A
Disclaimer:
- [529] 限制 : N/A
Limitation:
- [527] 條件 : N/A
Condition:
其他 : N/A
Others
- [220] 提交日期 : 13-08-2021
Date of Filing:
- [320] 聲稱具有優先權的日期 : 23-02-2021
Date of Priority Claimed:
- [310] 優先權申請編號 : AM 10537/2021
Priority Application Number:
- [340] 聲稱具有優先權 (部分) : N/A
Priority Claim Details:
- [330] 優先權申請的
國家、地區、地方 : AUSTRIA
Country, territory, area of
Priority Applications:

-
- [210] 商標申請編號 : 305727916
Application No.:

[540] 商標 :
Mark:

A



B



[550] 商標種類 : Ordinary
Mark Type:
一系列商標 : YES
Series Mark:

[571] 商標描述 : N/A
Mark Description:

[730] 註冊申請人的姓名 / 名稱、地址 : Dong Doi Tung Limited (當代通有限公司)
Applicant(s)' Name, Address: 12/F, Hang Wai Commercial Building,
231-233 Queen's Road East, Wanchai,
HONG KONG

[740/ 註冊申請人的送達地址 : ROBIN BRIDGE & JOHN LIU
750] Applicant's Address for 6th Floor, Emperor Commercial Centre,
Service: 39 Des Voeux Road Central,
HONG KONG

[511] 類別編號 : 6, 9, 11, 14, 16, 18, 20, 21, 24, 25, 28, 35, 36, 41, 42, 45
Class(es) No(s) .:

[511] 貨品 / 服務說明 : Class 11:
Specification: Installations and apparatus, all for lighting;
appliances for lighting; lighting fixtures;
decoration lamps; decorative lighting sets;
decorative lights; glass covers for lamps;
bulbs for lighting; LED (light emitting
diodes) lighting products; lamps; floor lamps;
table lamps; Christmas tree ornaments for
illumination [electric lights]; chandeliers;
candle lanterns; garden lights; night-lights;
lighters; electric fans; fountains; tea making
apparatus.

[526] 卸棄 : N/A
Disclaimer:

[529] 限制 : N/A
Limitation:

[527] 條件 : N/A
 Condition:
 其他 : N/A
 Others

[220] 提交日期 : 25-08-2021
 Date of Filing:

[320] 聲稱具有優先權的日期 : N/A
 Date of Priority Claimed:

[310] 優先權申請編號 : N/A
 Priority Application Number:

[340] 聲稱具有優先權 (部分) : N/A
 Priority Claim Details:

[330] 優先權申請的
 國家、地區、地方 : N/A
 Country, territory, area of
 Priority Applications:

[210] 商標申請編號 : 305737627
 Application No.:

[540] 商標 : A
 Mark:



B



[550] 商標種類 : Ordinary
 Mark Type:
 一系列商標 : YES
 Series Mark:

[571] 商標描述 : N/A
 Mark Description:

- [730] 註冊申請人的姓名 / 名稱、地址 : West Kowloon Cultural District Authority
Applicant(s)' WKCDA Tower, West Kowloon Cultural District,
Name, Address: No. 8 Austin Road West, Kowloon
HONG KONG
- [740/ 註冊申請人的送達地址 : HOGAN LOVELLS
750] Applicant's Address for 11th Floor, One Pacific Place
Service: 88 Queensway
HONG KONG
- [511] 類別編號 : 2, 3, 4, 8, 9, 11, 14, 16, 18, 20, 21, 22, 23, 24, 25, 26, 27,
Class(es) No(s) .: 28, 29, 30, 32, 33, 35, 39, 41, 43
- [511] 貨品 / 服務說明 : Class 11:
Specification: Coffee roasters; electric coffee brewers;
electric blankets, not for medical purposes;
heating cushions, electric, not for medical
purposes; deodorising apparatus, not for
personal use; sanitary apparatus and
installations; hand drying apparatus for
washrooms; lanterns for lighting; decorative
lighting sets; LED (light emitting diode)
lights; christmas tree ornaments for
illumination [electric lights]; cooking
apparatus and installations; cooking utensils,
electric; air cleaning apparatus; tobacco
roasters; apparatus and installations for
lighting, heating, cooling, steam generating,
drying, ventilating and water supply and
sanitary purposes.
- [526] 卸棄 : N/A
Disclaimer:
- [529] 限制 : N/A
Limitation:
- [527] 條件 : N/A
Condition:
其他 : N/A
Others
- [220] 提交日期 : 06-09-2021
Date of Filing:
- [320] 聲稱具有優先權的日期 : N/A
Date of Priority Claimed:
- [310] 優先權申請編號 : N/A
Priority Application Number:
- [340] 聲稱具有優先權 (部分) : N/A
Priority Claim Details:
- [330] 優先權申請的 N/A
國家、地區、地方 :
Country, territory, area of
Priority Applications:
-
- [210] 商標申請編號 : 305739409
Application No.:

[540] 商標 :
Mark:



[550] 商標種類 : Ordinary
Mark Type:
一系列商標 : NO
Series Mark:

[571] 商標描述 : The applicant claims the colours red and blue as elements of the trade mark.
Mark Description:

[730] 註冊申請人的姓名 / 名稱、地址 : HGS International Holding B.V.
Applicant(s) ' Nieuwe Kanaal 7
Name,Address: 6709 PA Wageningen
NETHERLANDS

[740/ 註冊申請人的送達地址 : DEACONS
750] Applicant's Address for 5th Floor,
Service: Alexandra House Central
HONG KONG

[511] 類別編號 : 7,9,11
Class(es) No(s) .:

[511] 貨品 / 服務說明 : Class 11:
Specification: Apparatus for lighting, heating, steam generating, cooking, refrigerating, drying, ventilating, water supply; Industrial ovens and furnaces (not for food or beverages); Evaporators; water baths; Air freezing apparatus; air extraction apparatus; Installations for air extraction; steam extraction apparatus; Distillation apparatus; Water chillers; Heaters; Heaters for laboratory containers; Cooling appliances and installations; Cooling installations and machines.

[526] 卸棄 : N/A
Disclaimer:

[529] 限制 : N/A
Limitation:

[527] 條件 : N/A
Condition:
其他 : N/A
Others

[220] 提交日期 : 07-09-2021
Date of Filing:

[320] 聲稱具有優先權的日期 : N/A
Date of Priority Claimed:

[310] 優先權申請編號 : N/A

Priority Application Number:

[340] 聲稱具有優先權 (部分): N/A

Priority Claim Details:

[330] 優先權申請的 N/A

國家、地區、地方:

Country, territory, area of

Priority Applications:

[210] 商標申請編號: 305743981

Application No.:

[540] 商標:

Mark:

The logo for KUMA features the word "KUMA" in a bold, black, sans-serif font. The letter "U" is stylized with two large, circular eyes above it, giving it a face-like appearance. The letter "T" is positioned inside the upper curve of the "U".

[550] 商標種類: 一般商標

Mark Type:

一系列商標:

否

Series Mark:

[571] 商標描述: 不適用

Mark Description:

[730] 註冊申請人的姓名 / 名稱、地址: 建材士多有限公司

Applicant(s)'

Name, Address:

香港

西灣河

筲箕灣道 15 號舖

[740/ 註冊申請人的送達地址: 建材士多有限公司

750] Applicant's Address for

Service:

香港

西灣河

筲箕灣道 15 號舖

[511] 類別編號: 11

Class(es) No(s):

[511] 貨品 / 服務說明: 類別 11:

Specification:

水過濾器; 冷凍設置和裝置; 坐廁; 沐浴裝置; 抽氣扇; 放濕機; 空氣清新機; 浴室裝置; 淋浴花灑; LED 照明器具; 照明設置和裝置

[526] 卸棄: 不適用

Disclaimer:

[529] 限制: 不適用

Limitation:

[527] 條件: 不適用

Condition:

其他 : 不適用
Others
[220] 提交日期 : 13-09-2021
Date of Filing:
[320] 聲稱具有優先權的日期 : 不適用
Date of Priority Claimed:
[310] 優先權申請編號 : 不適用
Priority Application Number:
[340] 聲稱具有優先權 (部分) : 不適用
Priority Claim Details:
[330] 優先權申請的
國家、地區、地方 : 不適用
Country, territory, area of
Priority Applications:

[210] 商標申請編號 : 305748012
Application No.:
[540] 商標 :
Mark:



[550] 商標種類 : 一般商標
Mark Type:
一系列商標 : 否
Series Mark:
[571] 商標描述 : 不適用
Mark Description:
[730] 註冊申請人的姓名 / 名稱、地址 : 深圳減字科技有限公司
Applicant(s) ' 中國
Name, Address: 廣東省深圳市
南山區粵海街道麻嶺社區深南大道 9968 號漢京金融中心 1405
[740/ 註冊申請人的送達地址 : 滙誠知識產權有限公司
750] Applicant's Address for 香港
Service: 灣仔軒尼詩道 8-12 號
中港大廈 8 樓

- [511] 類別編號: 11, 14, 20, 21, 35
Class(es) No(s) .:
- [511] 貨品 / 服務說明:
Specification:
- 類別 11:
燈; 照明設備和裝置; 空氣淨化用殺菌燈; 燙髮用燈; 美甲烤燈; 運載工具用燈; 電炊具; 冷凍設備和機器; 冰箱; 個人用電風扇; 加濕器; 頭髮用吹風機; 電加熱裝置; 煙霧機; 供暖裝置; 裝飾噴泉; 曬皮膚設備 (日光浴床); 蒸臉器具 (蒸汽浴); 毛巾消毒機; 浴室裝置; 飲水機; 飲用水過濾器; 便攜式取暖器; 熱水袋; 電暖器; 電熱襪; 打火機
- 類別 14:
未加工或半加工貴金屬; 貴金屬; 首飾盒; 寶石; 珠寶首飾; 首飾配件; 耳環; 首飾用小飾物; 貴金屬製鑰匙圈; 手錶; 錶帶; 計時儀器; 鐘; 鬧鐘
- 類別 20:
家具; 便攜式書桌; 茶几; 非金屬箱; 手持鏡子 (化妝鏡); 鏡子 (玻璃鏡); 竹工藝品; 草編製品 (不包括鞋、帽、蓆、墊); 木、蠟、石膏或塑膠裝飾品; 家養寵物窩; 寵物靠墊; 枕頭; 墊枕; 軟墊; 野營用睡墊; 野營床墊; 門用非金屬附件; 窗簾鉤; 塑料標籤
- 類別 21:
家用或廚房用容器; 杯; 玻璃製水杯; 日用玻璃器皿; 家庭用陶瓷製品; 瓷器裝飾品; 水晶製之裝飾品; 茶具 (餐具); 酒具; 咖啡具 (餐具); 洗衣用晾衣架; 嬰兒浴盆 (便攜式); 薰香爐; 梳子盒; 刷子; 梳; 牙刷; 電動牙刷; 牙籤; 化妝用具; 食物保溫容器; 非電便攜式冷藏箱; 手動清潔器具; 毛球去除器 (電動或非電動); 動物飼料槽; 寵物自動餵食碗; 室內植物培養箱; 誘殺昆蟲用電力裝置
- 類別 35:
為零售目的在通訊媒體上展示商品; 商業櫥窗布置; 廣告; 計算機網絡上的在線廣告; 商業管理和組織諮詢; 組織商業或廣告展覽; 為他人促銷產品服務; 為商品和服務的買賣雙方提供在線市場; 替他人推銷; 進出口代理; 人員招聘; 人事管理諮詢; 計算機文檔管理; 為商業或廣告目的彙編信息索引; 會計; 自動售貨機出租; 藥用、獸醫用、衛生用製劑和醫療用品的零售服務
- [526] 卸棄:
Disclaimer:
不適用

[529] 限制： 不適用
Limitation:

[527] 條件： 不適用
Condition:
其他： 不適用
Others

[220] 提交日期： 16-09-2021
Date of Filing:

[320] 聲稱具有優先權的日期： 不適用
Date of Priority Claimed:

[310] 優先權申請編號： 不適用
Priority Application Number:

[340] 聲稱具有優先權 (部分)： 不適用
Priority Claim Details:

[330] 優先權申請的 不適用
國家、地區、地方：
Country, territory, area of
Priority Applications:

[210] 商標申請編號： 305748689
Application No.:

[540] 商標： 305748689
Mark:



[550] 商標種類： Ordinary
Mark Type:
一系列商標： NO
Series Mark:

[571] 商標描述： N/A
Mark Description:

[730] 註冊申請人的姓名 / 名稱、地址： Kabushiki Kaisha Fujitsu General (Fujitsu
Applicant(s) ' General Limited)
Name, Address: 3-3-17, Suenaga
Takatsu-ku, Kawasaki 213-8502
JAPAN

[740/ 註冊申請人的送達地址 : EMILY YIP & CO LIMITED
750] Applicant's Address for 1st Floor, Kingsfield Centre
Service: 18 Shell Street, Fortress Hill
HONG KONG
[511] 類別編號 : 9,11,42
Class(es) No(s) .: Class 11:
[511] 貨品 / 服務說明 : Hot water heating installations and their
Specification: parts and fittings; hot air apparatus; heating
boilers; air purifying apparatus and machines;
ionization apparatus for the treatment of air
or water; air deodorizing apparatus; air-
conditioning apparatus and their parts and
fittings; air-conditioning installations and
their parts and fittings; filters for air
conditioning; air cooling apparatus; heating
apparatus for solid, liquid or gaseous fuels;
dehumidifiers; underfloor heating apparatus
and installations; heating apparatus,
electric; deodorising apparatus, not for
personal use; heating apparatus; heating
installations; heat exchangers, other than
parts of machines; refrigerating appliances
and installations; refrigerating apparatus and
machines; cooling apparatus; electric cooling
apparatus for personal use; small-sized air-
conditioning apparatus; portable air-
conditioning apparatus; air conditioners for
industrial purposes; freezing machines and
apparatus for industrial purposes; cooking
apparatus and installations for commercial
use; industrial dish drying apparatus and
installations; dish disinfectant apparatus for
industrial purposes; kitchen sinks for
industrial purposes; household electrothermic
appliances; warming pans, non-electric; pocket
warmers; hot water bottles.

[526] 卸棄 : N/A
Disclaimer:
[529] 限制 : N/A
Limitation:
[527] 條件 : N/A
Condition:
其他 : N/A
Others
[220] 提交日期 : 17-09-2021
Date of Filing:
[320] 聲稱具有優先權的日期 : N/A
Date of Priority Claimed:
[310] 優先權申請編號 : N/A
Priority Application Number:
[340] 聲稱具有優先權 (部分) : N/A
Priority Claim Details:
[330] 優先權申請的 N/A

國家、地區、地方：

Country, territory, area of
Priority Applications:

[210] 商標申請編號： 305748698
Application No.:

[540] 商標：
Mark:



[550] 商標種類： Ordinary
Mark Type:
一系列商標： NO
Series Mark:

[571] 商標描述： N/A
Mark Description:

[730] 註冊申請人的姓名 / 名稱、地址： Kabushiki Kaisha Fujitsu General (Fujitsu
Applicant(s) ' General Limited)
Name, Address: 3-3-17, Suenaga
Takatsu-ku, Kawasaki 213-8502
JAPAN

[740/ 註冊申請人的送達地址： EMILY YIP & CO LIMITED
750] Applicant's Address for 1st Floor, Kingsfield Centre
Service: 18 Shell Street, Fortress Hill
HONG KONG

[511] 類別編號： 9, 11, 42
Class(es) No(s) .:

[511] 貨品 / 服務說明： Class 11:
Specification: Hot water heating installations and their
parts and fittings; hot air apparatus; heating
boilers; air purifying apparatus and machines;
ionization apparatus for the treatment of air
or water; air deodorizing apparatus; air-
conditioning apparatus and their parts and
fittings; air-conditioning installations and
their parts and fittings; filters for air
conditioning; air cooling apparatus; heating
apparatus for solid, liquid or gaseous fuels;

dehumidifiers; underfloor heating apparatus and installations; heating apparatus, electric; deodorising apparatus, not for personal use; heating apparatus; heating installations; heat exchangers, other than parts of machines; refrigerating appliances and installations; refrigerating apparatus and machines; cooling apparatus; electric cooling apparatus for personal use; small-sized air-conditioning apparatus; portable air-conditioning apparatus; air conditioners for industrial purposes; freezing machines and apparatus for industrial purposes; cooking apparatus and installations for commercial use; industrial dish drying apparatus and installations; dish disinfectant apparatus for industrial purposes; kitchen sinks for industrial purposes; household electrothermic appliances; warming pans, non-electric; pocket warmers; hot water bottles.

- [526] 卸棄 : N/A
Disclaimer:
- [529] 限制 : N/A
Limitation:
- [527] 條件 : N/A
Condition:
其他 : N/A
Others
- [220] 提交日期 : 17-09-2021
Date of Filing:
- [320] 聲稱具有優先權的日期 : N/A
Date of Priority Claimed:
- [310] 優先權申請編號 : N/A
Priority Application Number:
- [340] 聲稱具有優先權 (部分) : N/A
Priority Claim Details:
- [330] 優先權申請的 : N/A
國家、地區、地方 :
Country, territory, area of
Priority Applications:
-
-

- [210] 商標申請編號 : 305756121
Application No.:

[540] 商標：
Mark:



喜马拉雅虎

- [550] 商標種類：
Mark Type: 一般商標
一系列商標：
Series Mark: 否
- [571] 商標描述：
Mark Description: 不適用
- [730] 註冊申請人的姓名 / 名稱、地址：
Applicant(s) ' Name, Address: 紀榮俊
香港
九龍觀塘巧明街 116-118 號
萬年工業大廈 C 座 4 樓 C21 室
- [740/ 註冊申請人的送達地址：
750] Applicant's Address for Service: 紀榮俊
香港
九龍觀塘巧明街 116-118 號
萬年工業大廈 C 座 4 樓 C21 室
- [511] 類別編號：
Class(es) No(s) .: 7, 9, 11, 25
- [511] 貨品 / 服務說明：
Specification: 類別 11:
手電筒；水過濾器；冷凍設備和裝置；坐廁；沐浴裝置；供暖設備和裝置；抽油煙機；抽氣扇；抽濕機；放濕機；空氣清新機；空調設備和裝置；非醫用電熱毯；浴室裝置；淋浴花灑；烹調設備和裝置；焗爐；發光二極管 (LED) 照明器具；照明設備和裝置；聖誕樹用電燈；電水壺；電咖啡機；電風扇；電乾衣機；製冰機；製麵包機；燈；燈泡；燒烤機；頭髮用吹風機
- [526] 卸棄：
Disclaimer: 不適用
- [529] 限制：
Limitation: 不適用
- [527] 條件：
Condition: 不適用

其他 : 不適用
Others

[220] 提交日期 : 27-09-2021
Date of Filing:

[320] 聲稱具有優先權的日期 : 不適用
Date of Priority Claimed:

[310] 優先權申請編號 : 不適用
Priority Application Number:

[340] 聲稱具有優先權 (部分) : 不適用
Priority Claim Details:

[330] 優先權申請的
國家、地區、地方 : 不適用
Country, territory, area of
Priority Applications:

[210] 商標申請編號 : 305756176
Application No.:

[540] 商標 :
Mark:



HIMALA TIGER

[550] 商標種類 : 一般商標
Mark Type:

一系列商標 : 否
Series Mark:

[571] 商標描述 : 不適用
Mark Description:

[730] 註冊申請人的姓名 / 名稱、地址 : 紀榮俊
Applicant(s) ' 香港
Name, Address:
九龍觀塘巧明街 116-118 號
萬年工業大廈 C 座 4 樓 C21 室

[740/ 註冊申請人的送達地址 : 紀榮俊
750] Applicant's Address for 香港
Service: 九龍觀塘巧明街 116-118 號
萬年工業大廈 C 座 4 樓 C21 室

[511] 類別編號 : 7, 9, 11, 25
Class(es) No(s) .:

[511] 貨品 / 服務說明 : Specification:	類別 11: 手電筒 ; 水過濾器 ; 冷凍設備和裝置 ; 坐廁 ; 沐浴裝置 ; 供暖設備和裝置 ; 抽油煙機 ; 抽氣扇 ; 抽濕機 ; 放濕機 ; 空氣清新機 ; 空調設備和裝置 ; 非醫用電熱毯 ; 浴室裝置 ; 淋浴花灑 ; 烹調設備和裝置 ; 焗爐 ; 發光二極管 (LED) 照明器具 ; 照明設備和裝置 ; 聖誕樹用電燈 ; 電水壺 ; 電咖啡機 ; 電風扇 ; 電乾衣機 ; 製冰機 ; 製麵包機 ; 燈 ; 燈泡 ; 燒烤機 ; 頭髮用吹風機
[526] 卸棄 : Disclaimer:	不適用
[529] 限制 : Limitation:	不適用
[527] 條件 : Condition: 其他 : Others	不適用
[220] 提交日期 : Date of Filing:	27-09-2021
[320] 聲稱具有優先權的日期 : Date of Priority Claimed:	不適用
[310] 優先權申請編號 : Priority Application Number:	不適用
[340] 聲稱具有優先權 (部分) : Priority Claim Details:	不適用
[330] 優先權申請的 國家、地區、地方 : Country, territory, area of Priority Applications:	不適用

[210] 商標申請編號 : 305758750
Application No.:

[540] 商標 :
Mark:



[550] 商標種類 : Ordinary
Mark Type:

- 一系列商標 : NO
Series Mark:
- [571] 商標描述 : The applicant claims the colours blue (Pantone 293C) and black (Pantone Black C) as elements of the trade mark.
Mark Description:
- [730] 註冊申請人的姓名 / 名稱、地址 : AP TOP TECHNOLOGY LIMITED
Applicant(s) ' Room 409, 4/F Lippo Sun Plaza,
Name, Address: 28 Canton Road, Tsim Sha Tsui
HONG KONG
- [740/ 註冊申請人的送達地址 : AP TOP TECHNOLOGY LIMITED
750] Applicant's Address for Room 409, 4/F Lippo Sun Plaza,
Service: 28 Canton Road, Tsim Sha Tsui
HONG KONG
- [511] 類別編號 : 11
Class(es) No(s) .:
- [511] 貨品 / 服務說明 : Class 11:
Specification: ventilation & air-conditioning apparatus and installations; ventilation & air-conditioning installations for vehicles; air filtering installations; air purifying apparatus and machines; filters for air conditioning; sterilizers; light-emitting diodes [LED] lighting apparatus; ionization apparatus for the treatment of air or water
- [526] 卸棄 : N/A
Disclaimer:
- [529] 限制 : N/A
Limitation:
- [527] 條件 : N/A
Condition:
- 其他 : N/A
Others
- [220] 提交日期 : 28-09-2021
Date of Filing:
- [320] 聲稱具有優先權的日期 : N/A
Date of Priority Claimed:
- [310] 優先權申請編號 : N/A
Priority Application Number:
- [340] 聲稱具有優先權 (部分) : N/A
Priority Claim Details:
- [330] 優先權申請的 N/A
國家、地區、地方 :
Country, territory, area of
Priority Applications:
-
- [210] 商標申請編號 : 305764096
Application No.:

[540] 商標 :
Mark:

A



B



- [550] 商標種類 : Ordinary
Mark Type:
一系列商標 : YES
Series Mark:
- [571] 商標描述 : N/A
Mark Description:
- [730] 註冊申請人的姓名 / 名稱、地址 : Merhein Limited (立海有限公司)
Applicant(s) ' Rooms 05-15, 13A/F, South Tower, World Finance
Name, Address: Centre,
Harbour City, 17 Canton Road, Tsim Sha Tsui,
Kowloon,
HONG KONG
- [740/ 註冊申請人的送達地址 : ACCOLADE IP LIMITED
750] Applicant's Address for 10/F, Fu Fai Comm. Ctr.,
Service: 27 Hillier Street, Sheung Wan,
HONG KONG
- [511] 類別編號 : 11
Class(es) No(s) .:
- [511] 貨品 / 服務說明 : Class 11:
Specification: Ceiling lights; discharge tubes, electric, for
lighting; fairy lights for festive decoration;
string lights for festive decoration; light
bulbs; light bulbs, electric; light diffusers;
light projectors; light-emitting diodes [LED]
luminaires; lighting apparatus, namely,
lighting installations; luminous tubes for
lighting; air-conditioning apparatus; air-
conditioning installations; anti-glare devices
for vehicles [lamp fittings]; anti-dazzle
devices for vehicles [lamp fittings]; aquarium
lights; arc lamps; bicycle lights; burners for
lamps; carbon for arc lamps; chandeliers;
curing lamps, not for medical purposes;
curling lamps; directional lights for
bicycles; diving lights; filaments for
electric lamps; filters for air conditioning;
friction lighters for igniting gas; gas lamps;
gas lighters; germicidal lamps for purifying
air; head torches; portable headlamps;
headlights for automobiles; laboratory lamps;
lamp chimneys; lamp glasses; lamp globes;
globes for lamps; lamp mantles; lamp casings;

lamp reflectors; electric lamps; lamps; lampshade holders; lampshades; lanterns for lighting; light bulbs for directional signals for vehicles; light-emitting diodes [LED] lighting apparatus; lighting apparatus and installations; lighting apparatus for vehicles; lighting installations for air vehicles; lights for automobiles; automobile lights; lights for vehicles; lights, electric, for Christmas trees; electric lights for Christmas trees; magnesium filaments for lighting; miners' lamps; motorcycle lights; nail lamps; oil lamps; radiators, electric; safety lamps; searchlights; sockets for electric lamps; solar furnaces; solar thermal collectors [heating]; standard lamps; floor lamps; street lamps; electric torches; electric flashlights; ultraviolet ray lamps, not for medical purposes; vehicle headlights.

- [526] 卸棄 : N/A
Disclaimer:
- [529] 限制 : N/A
Limitation:
- [527] 條件 : N/A
Condition:
其他 : N/A
Others
- [220] 提交日期 : 04-10-2021
Date of Filing:
- [320] 聲稱具有優先權的日期 : N/A
Date of Priority Claimed:
- [310] 優先權申請編號 : N/A
Priority Application Number:
- [340] 聲稱具有優先權 (部分) : N/A
Priority Claim Details:
- [330] 優先權申請的 : N/A
國家、地區、地方 :
Country, territory, area of
Priority Applications:

-
- [210] 商標申請編號 : 305768470
Application No.:

[540] 商標 :
Mark:



[550] 商標種類 : Ordinary
Mark Type:
一系列商標 : NO
Series Mark:

[571] 商標描述 : N/A
Mark Description:

[730] 註冊申請人的姓名 / 名稱、地址 : FAST WISE (HONG KONG) LIMITED
Applicant(s)' ROOM 18, 3/F., WAH YUEN FACTORY BUILDING,
Name, Address: 18 ELM, TAI KOK TSUI, KOWLOON,
HONG KONG

[740/ 註冊申請人的送達地址 : NAVSTAR INTERNATIONAL COMMERCE LIMITED
750] Applicant's Address for Rm 1508, 15/F., Office Tower Two, Grand Plaza
Service: 625 Nathan Road, Kowloon
HONG KONG

[511] 類別編號 : 11
Class(es) No(s) .:

[511] 貨品 / 服務說明 : Class 11:
Specification: Kitchen ranges [ovens]; autoclaves, electric,
for cooking; Kettles, electric; Microwave
ovens [cooking apparatus]; Refrigerators; Fans
[air-conditioning]; Hair driers; Heaters for
baths; Toilet bowls; Water filtering
apparatus; Extractor hoods for kitchens; Mixer
taps for water pipes; Air cooling apparatus;
electric stoves; water heaters; acetylene
flares

[526] 卸棄 : N/A
Disclaimer:

[529] 限制 : N/A
Limitation:

[527] 條件 : N/A
Condition:
其他 : N/A
Others

[220] 提交日期 : 09-10-2021
Date of Filing:

[320] 聲稱具有優先權的日期 : N/A
Date of Priority Claimed:

[310] 優先權申請編號 : N/A
Priority Application Number:

[340] 聲稱具有優先權 (部分) : N/A

Priority Claim Details:

[330] 優先權申請的 N/A
國家、地區、地方：
Country, territory, area of
Priority Applications:

[210] 商標申請編號： 305769109
Application No.:

[540] 商標：
Mark:

Pro Induction
極專

[550] 商標種類： 一般商標
Mark Type:
一系列商標： 否
Series Mark:

[571] 商標描述： 不適用
Mark Description:

[730] 註冊申請人的姓名 / 名稱、地址： 冠致有限公司
Applicant(s) ' 香港
Name, Address: 葵芳大連排道 144-150 號
金豐工業大廈二期 13 樓 L 室

[740/ 註冊申請人的送達地址： 冠致有限公司
750] Applicant's Address for 香港
Service: 葵芳大連排道 144-150 號
金豐工業大廈二期 13 樓 L 室

[511] 類別編號： 11
Class(es) No(s) .:

[511] 貨品 / 服務說明： 類別 11：
Specification: 烹調及民用電器加熱設備，製冷、冷藏設備，乾燥、通風、空
調設備，加溫、蒸氣設備，消毒和淨化設備，小型取暖器，衛
生設備。

[526] 卸棄： 不適用
Disclaimer:

[529] 限制： 不適用
Limitation:

[527] 條件： 不適用
Condition:
其他： 不適用
Others

- [220] 提交日期 : 11-10-2021
Date of Filing:
- [320] 聲稱具有優先權的日期 : 不適用
Date of Priority Claimed:
- [310] 優先權申請編號 : 不適用
Priority Application Number:
- [340] 聲稱具有優先權 (部分) : 不適用
Priority Claim Details:
- [330] 優先權申請的 不適用
國家、地區、地方 :
Country, territory, area of
Priority Applications:
-
-

類別 Class 12

[210] 商標申請編號 : 305439619

Application No.:

[540] 商標 :

Mark:

The logo consists of the words "POWER" and "SHARE" stacked vertically. Both words are in a bold, black, sans-serif font. The letters are slightly slanted to the right. The "E"s in both words have a unique design with three horizontal bars extending to the right.

[550] 商標種類 : Ordinary

Mark Type:

一系列商標 :

NO

Series Mark:

[571] 商標描述 : N/A

Mark Description:

[730] 註冊申請人的姓名 / 名稱、地址 :

Applicant(s)'

Name, Address:

POSITEC GROUP LIMITED
LEVEL 54, HOPEWELL CENTRE,
183 QUEEN'S ROAD EAST,
HONG KONG

[740/ 註冊申請人的送達地址 :

750] Applicant's Address for
Service:

CHINAHONGKONG IP LIMITED
1502, 15/F, Capital Centre, 151 Gloucester
Road, Wanchai
HONG KONG

[511] 類別編號 :

Class(es) No(s) .:

7, 9, 11, 12

[511] 貨品 / 服務說明 :

Specification:

Class 12:

Vehicles; apparatus for locomotion by land, air or water; air pumps being parts of vehicles; anti-theft alarm apparatus for vehicles; apparatus for locomotion by air; apparatus for locomotion by land; apparatus for locomotion by water; articles for use in supporting goods on vehicle roofs; babies' strollers; bells for bicycles; bells for cycles; bicycle racks; bicycle tyres; braking apparatus for bicycles; cable transport installations; canoes; car safety seats for children; car seats; car theft alarms; carpets adapted [shaped] for automobiles; carriages for children; carriages for invalids; carriers for use on vehicles; casings for pneumatic tyres; casters for trolleys [vehicles]; castors [vehicle wheels]; dollies; dress guards for bicycles; electric driving motors for land vehicles; electric engines for land vehicles; electrically operated scooters; electrically operated wheelchairs; electrically powered scooters; engines for automobiles; fan motors for land vehicles;

frames for bicycles; golf trolleys; hand carts; handle stems; handlebar grips; handlebars; industrial trucks; inflatable boats; inner tubes for bicycles; inner tubes for cycles; inner tubes for pneumatic tyres; inner tubes for tyres; interior fittings for vehicles; kayaks; kickstands for cycles; lift trucks; lifting cars; metal bells for bicycles; motor driven apparatus for pulling [transporting]; motor scooters; motorised surfboards; mountain bikes; patches for tyres; patching materials for tyres; pedal bicycles; propellers for boats; pumps for bicycles; pumps for cycles; pumps for inflating bicycle tyres; remote control security [anti-theft] devices for vehicles; remote controlled vehicles; repairing materials of rubber for repairing tyres; rims for wheels of bicycles; saddle covers for bicycles; sailing boats; sand yachts; shopping carts; shopping trolleys; snow chains for motor vehicles; snow chains for vehicle wheels; spikes for tyres; sports boats; starter motors for land vehicles; starting devices for engines of land vehicles; starting devices for internal combustion engines; theft prevention devices for vehicles; toe straps for use on bicycles; toeclips for use on bicycles; trailers; transporters for use in sporting activities; trolleys for the transportation of machines; tubeless tyres for bicycles; tyres; unmanned vehicles; vehicle windshield cleaning apparatus [parts of the vehicle]; water vessels; wheels for motorcycles; parts fittings and accessories in this class for the aforesaid goods.

- [526] 卸棄 : N/A
Disclaimer:
- [529] 限制 : N/A
Limitation:
- [527] 條件 : N/A
Condition:
其他 : By consent, No. 302279322
Others
- [220] 提交日期 : 06-11-2020
Date of Filing:
- [320] 聲稱具有優先權的日期 : N/A
Date of Priority Claimed:
- [310] 優先權申請編號 : N/A
Priority Application Number:
- [340] 聲稱具有優先權 (部分) : N/A
Priority Claim Details:
- [330] 優先權申請的
國家、地區、地方 : N/A

Country, territory, area of
Priority Applications:

[210]	商標申請編號 : Application No.:	305482936
[540]	商標 : Mark:	A  B 
[550]	商標種類 : Mark Type:	一般商標
	一系列商標 : Series Mark:	是
[571]	商標描述 : Mark Description:	不適用
[730]	註冊申請人的姓名 / 名稱、地址 : Applicant(s)' Name, Address:	中國航發商用航空發動機有限責任公司 中國 上海市閔行區 蓮花南路 3998 號
[740/ 750]	註冊申請人的送達地址 : Applicant's Address for Service:	誠通專利商標 (香港) 有限公司 香港 灣仔港灣道一號 會展廣場辦公大樓 34 樓 09 室
[511]	類別編號 : Class(es) No(s) .:	7, 9, 12
[511]	貨品 / 服務說明 : Specification:	類別 12: 運載工具轉向信號裝置; 運載工具用操縱桿; 運載工具用懸置 減震器; 運載工具用制動蹄; 運載工具緩衝器; 航空裝置、機 器和設備; 運載工具用油箱蓋; 飛機的彈射座椅; 航空器; 空中運載工具。
[526]	卸棄 : Disclaimer:	不適用
[529]	限制 : Limitation:	不適用
[527]	條件 : Condition:	不適用

其他 : 不適用
Others
[220] 提交日期 : 18-12-2020
Date of Filing:
[320] 聲稱具有優先權的日期 : 不適用
Date of Priority Claimed:
[310] 優先權申請編號 : 不適用
Priority Application Number:
[340] 聲稱具有優先權 (部分) : 不適用
Priority Claim Details:
[330] 優先權申請的
國家、地區、地方 : 不適用
Country, territory, area of
Priority Applications:

[210] 商標申請編號 : 305482945
Application No.:

[540] 商標 :
Mark:

A



B



[550] 商標種類 : 一般商標
Mark Type:
一系列商標 : 是
Series Mark:

[571] 商標描述 : 不適用
Mark Description:

[730] 註冊申請人的姓名 / 名稱、地址 : 中國航發商用航空發動機有限責任公司
Applicant(s) ' 中國
Name, Address:

上海市閔行區

蓮花南路 3998 號

[740/ 註冊申請人的送達地址 : 誠通專利商標 (香港) 有限公司
750] Applicant's Address for 香港
Service: 灣仔港灣道一號

會展廣場辦公大樓 34 樓 09 室

[511] 類別編號 : 7, 9, 12
Class(es) No(s) .:

[511] 貨品 / 服務說明 : Specification:	類別 12: 運載工具轉向信號裝置; 運載工具用操縱桿; 運載工具用懸置減震器; 運載工具用制動蹄; 運載工具緩衝器; 航空裝置、機器和設備; 運載工具用油箱蓋; 飛機的彈射座椅; 航空器; 空中運載工具。
[526] 卸棄 : Disclaimer:	不適用
[529] 限制 : Limitation:	不適用
[527] 條件 : Condition:	不適用
其他 : Others	不適用
[220] 提交日期 : Date of Filing:	18-12-2020
[320] 聲稱具有優先權的日期 : Date of Priority Claimed:	不適用
[310] 優先權申請編號 : Priority Application Number:	不適用
[340] 聲稱具有優先權 (部分) : Priority Claim Details:	不適用
[330] 優先權申請的 國家、地區、地方 : Country, territory, area of Priority Applications:	不適用

[210] 商標申請編號 : 305664141
Application No.:

[540] 商標 :
Mark:



[550] 商標種類 : Ordinary
Mark Type:

一系列商標 : NO

Series Mark:

[571] 商標描述 : N/A

Mark Description:

[730] 註冊申請人的姓名 / 名稱、地址 : voestalpine AG
Applicant (s) ' voestalpine-Str. 1
Name, Address: 4020 Linz
AUSTRIA

[740/ 註冊申請人的送達地址 : WENPING PATENT & TRADE MARK AGENT LIMITED
 750] Applicant's Address for 1701 Tung Wai Commercial Building,
 Service: 111 Gloucester Road,
 HONG KONG

[511] 類別編號 : 1, 6, 9, 12, 35, 37, 40
 Class(es) No(s) .:

[511] 貨品/服務說明 : Class 12:
 Specification: Vehicles and conveyances; vehicles for
 transport by air; parts and fittings for
 vehicles, land vehicles, water vehicles, air
 vehicles and space vehicles; engines and parts
 of engines for vehicles, land vehicles, water
 vehicles, air vehicles and space vehicles, not
 included in other classes; turbines and engine
 components for vehicles for transport by air;
 structural parts for vehicles, land vehicles,
 water vehicles, air vehicles and space
 vehicles; chassis parts, axle parts and gear
 parts for vehicles and land vehicles; parts
 and fittings for motor vehicles; chassis
 parts, structural parts and body parts for
 motor vehicles; outer skin parts of motor
 vehicles; panels for vehicle bodies; hood
 shields as structural parts of motor vehicles;
 casings for components of motor vehicles
 (other than for engines); components of metal
 for automobile construction (parts of land
 vehicles); components of press-hardening steel
 for automobile construction (parts of land
 vehicles); components of press-hardening steel
 for automobile construction, namely columns,
 bumpers, sills, side impact protection, side-
 members, crossmembers and crash boxes, all
 being parts of land vehicles; parts and
 fittings of all aforesaid goods, included in
 this class.

[526] 卸棄 : N/A
 Disclaimer:

[529] 限制 : N/A
 Limitation:

[527] 條件 : N/A
 Condition:

其他 : N/A
 Others

[220] 提交日期 : 22-06-2021
 Date of Filing:

[320] [310] [340] [330]
 聲稱具有優先權的日期: 優先權申請編號: 聲稱具有優先權 (部分): 優先權申請的
 Date of Priority Priority Application Priority Claim 國家、地區、地方:
 Claimed: No.: Details: Country, territory,
 area of Priority
 Applications:

23-12-2020 EM 018363859 For Classes 6, 12, EUROPEAN UNION
35, and for services
listed in (A) in
Classes 37, and 40.

10-06-2021 AM 335/2021 For Classes 1, 9, AUSTRIA
and for services
listed in (B) in
Classes 37, and 40.

-
- [210] 商標申請編號 : 305701842AA
Application No.:
- [540] 商標 : A **科軒動力(控股)有限公司**
Mark: B **科轩动力 (控股) 有限公司**
- [550] 商標種類 : 一般商標
Mark Type: 是
一系列商標 :
Series Mark:
- [571] 商標描述 : 不適用
Mark Description:
- [730] 註冊申請人的姓名 / 名稱、地址 : 科軒動力 (控股) 有限公司
Applicant(s) ' 香港
Name, Address: 灣仔駱克道 333 號
中國網絡中心 46 樓
- [740/ 註冊申請人的送達地址 : 科軒動力 (控股) 有限公司
750] Applicant's Address for 香港
Service: 灣仔駱克道 333 號
中國網絡中心 46 樓
- [511] 類別編號 : 9, 12
Class(es) No(s) .:
- [511] 貨品 / 服務說明 : 類別 12:
Specification: 陸地運載工具包括電動車 ; 汽車 ; 運輸車 ; 公共巴士 ; 旅遊巴士 ; 小巴 ; 陸地運載裝置及組件如電動車組件 ; 汽車底盤 ; 摩打 (陸地車輛用)
- [526] 卸棄 : 不適用
Disclaimer:
- [529] 限制 : 不適用
Limitation:
- [527] 條件 : 不適用
Condition:

其他 : 不適用
Others
[220] 提交日期 : 29-07-2021
Date of Filing:
[320] 聲稱具有優先權的日期 : 不適用
Date of Priority Claimed:
[310] 優先權申請編號 : 不適用
Priority Application Number:
[340] 聲稱具有優先權 (部分) : 不適用
Priority Claim Details:
[330] 優先權申請的
國家、地區、地方 : 不適用
Country, territory, area of
Priority Applications:

[210] 商標申請編號 : 305701842AB
Application No.:

[540] 商標 :
Mark:

A

科軒動力

B

科轩动力

[550] 商標種類 : 一般商標
Mark Type:
一系列商標 : 是
Series Mark:

[571] 商標描述 : 不適用
Mark Description:

[730] 註冊申請人的姓名 / 名稱、地址 : 科軒動力 (控股) 有限公司
Applicant(s) ' Name, Address:
香港

灣仔駱克道 333 號

中國網絡中心 46 樓

[740/ 註冊申請人的送達地址 : 科軒動力 (控股) 有限公司
750] Applicant's Address for Service:
香港

灣仔駱克道 333 號

中國網絡中心 46 樓

[511] 類別編號 : 9, 12
Class(es) No(s) .:

[511] 貨品 / 服務說明 : Specification:	類別 12: 陸地運載工具包括電動車 ; 汽車 ; 運輸車 ; 公共巴士 ; 旅遊巴士 ; 小巴 ; 陸地運載裝置及組件如電動車組件 ; 汽車底盤 ; 摩打 (陸地車輛用)
[526] 卸棄 : Disclaimer:	不適用
[529] 限制 : Limitation:	不適用
[527] 條件 : Condition: 其他 : Others	不適用 不適用
[220] 提交日期 : Date of Filing:	29-07-2021
[320] 聲稱具有優先權的日期 : Date of Priority Claimed:	不適用
[310] 優先權申請編號 : Priority Application Number:	不適用
[340] 聲稱具有優先權 (部分) : Priority Claim Details:	不適用
[330] 優先權申請的 國家、地區、地方 : Country, territory, area of Priority Applications:	不適用

[210] 商標申請編號 : Application No.:	305708386
[540] 商標 : Mark:	CLOi Order
[550] 商標種類 : Mark Type: 一系列商標 : Series Mark:	Ordinary NO
[571] 商標描述 : Mark Description:	N/A
[730] 註冊申請人的姓名 / 名稱、地址 : Applicant (s) ' Name, Address:	LG Jeonja Joo-Sik-Hoi-Sa (LG Electronics Inc.) 128, Yeoui-daero, Yeongdeungpo-gu, Seoul, 07336, REPUBLIC OF KOREA
[740/ 註冊申請人的送達地址 : 750] Applicant's Address for Service:	SPRUSON & FERGUSON (HONG KONG) LIMITED 5001 Hopewell Centre 183 Queen's Road East, Wan Chai HONG KONG

- [511] 類別編號 : 7, 9, 12, 35, 38, 42, 43
Class(es) No(s) :
[511] 貨品 / 服務說明 : Class 12:
Specification: Self-propelled electric vehicle; Electric vehicles; Luggage carriers for vehicles; Motorized luggage carts; Shopping handcarts; Motorized food carts; Automatic transport vehicles; Self-driving cars; Self-driving delivery robots for indoor use; Remotely controlled land vehicle [for transport].
- [526] 卸棄 : N/A
Disclaimer:
[529] 限制 : N/A
Limitation:
[527] 條件 : N/A
Condition:
其他 : N/A
Others
- [220] 提交日期 : 04-08-2021
Date of Filing:
[320] 聲稱具有優先權的日期 : N/A
Date of Priority Claimed:
[310] 優先權申請編號 : N/A
Priority Application Number:
[340] 聲稱具有優先權 (部分) : N/A
Priority Claim Details:
[330] 優先權申請的
國家、地區、地方 : N/A
Country, territory, area of
Priority Applications:
-
-

- [210] 商標申請編號 : 305719267
Application No.:
[540] 商標 :
Mark:

里創

- [550] 商標種類 : 一般商標
Mark Type:
一系列商標 : 否
Series Mark:

- [571] 商標描述 : 不適用
Mark Description:
- [730] 註冊申請人的姓名 / 名稱、地址 : 楊歡以 里創 之名營業
Applicant(s) ' 香港
Name, Address: 新界荃灣灰窰角街 50-56 號
昌泰工業大廈 10 樓 A50 室
- [740/ 註冊申請人的送達地址 : 里創
750] Applicant's Address for 香港
Service: 荃灣灰窰角街 50-56 號
昌泰工業大廈 10 樓 A50 室
- [511] 類別編號 : 12
Class(es) No(s) .:
- [511] 貨品 / 服務說明 : 類別 12:
Specification: 汽車窗玻璃雨刷、汽車車身套件、車輛設備和裝飾配件、以及
售後汽車零部件; 車身裝飾、車輛裝飾; 機動車輛、摩托車、
自行車及其零件和配件; 機動車輛及其裝飾 (外部和內部);
全部包括於類別 12。
- [526] 卸棄 : 申請人並不分別具有中文字"里"和"創"的專有使用權。
Disclaimer:
- [529] 限制 : 不適用
Limitation:
- [527] 條件 : 不適用
Condition:
其他 : 不適用
Others
- [220] 提交日期 : 17-08-2021
Date of Filing:
- [320] 聲稱具有優先權的日期 : 不適用
Date of Priority Claimed:
- [310] 優先權申請編號 : 不適用
Priority Application Number:
- [340] 聲稱具有優先權 (部分) : 不適用
Priority Claim Details:
- [330] 優先權申請的 不適用
國家、地區、地方 :
Country, territory, area of
Priority Applications:
-
- [210] 商標申請編號 : 305726511
Application No.:

[540] 商標 :
Mark:

A



B



- [550] 商標種類 : Ordinary
Mark Type:
一系列商標 : YES
Series Mark:
- [571] 商標描述 : The applicant claims the colour INDIGO BLUE (PANTONE 7694 C) as an element of Mark "A" in the series.
Mark Description:
- [730] 註冊申請人的姓名 / 名稱、地址 : Moriroku Holdings Kabushiki Kaisha (Moriroku Holdings Company, Ltd.)
Applicant(s) ' Name, Address: 1-1, Minamiaoyama 1-chome, Minato-ku, Tokyo, JAPAN
- [740/ 註冊申請人的送達地址 : NTD PATENT & TRADE MARK AGENCY LIMITED
750] Applicant's Address for Service: Units 1805-6, 18/F., Greenfield Tower, Concordia Plaza, No. 1 Science Museum Road, Tsimshatsui East, Kowloon, HONG KONG
- [511] 類別編號 : 1, 12, 35
Class(es) No(s) .:
- [511] 貨品 / 服務說明 : Class 12:
Specification: Automobiles and their parts and fittings; two-wheeled motor vehicles, bicycles and their parts and fittings; radiator grills, not of metal, for vehicles; radiator grills of metal for vehicles; hoods for vehicle engines; bumpers for automobiles; spoilers for automobiles; petrol tank caps for motor cars; air pumps [vehicle accessories]; automobile dashboards; automotive interior trim; axles for vehicles; axle journals; gear boxes for land vehicles; transmissions for land vehicles; shock absorbers for automobiles; vessels and their parts and fittings.

[526] 卸棄: N/A
Disclaimer:

[529] 限制: N/A
Limitation:

[527] 條件: N/A
Condition:
其他: N/A
Others

[220] 提交日期: 24-08-2021
Date of Filing:

[320] 聲稱具有優先權的日期: N/A
Date of Priority Claimed:

[310] 優先權申請編號: N/A
Priority Application Number:

[340] 聲稱具有優先權 (部分): N/A
Priority Claim Details:

[330] 優先權申請的
國家、地區、地方: N/A
Country, territory, area of
Priority Applications:

[210] 商標申請編號: 305733108
Application No.:

[540] 商標:
Mark:



[550] 商標種類: Ordinary
Mark Type:
一系列商標: NO
Series Mark:

[571] 商標描述: N/A
Mark Description:

[730] 註冊申請人的姓名/名稱、地址: 42dot Inc.
Applicant(s) ' 9th Floor, 2621, Nambusunhwan-ro,
Name, Address: Gangnam-gu, Seoul,
REPUBLIC OF KOREA

[740/ 註冊申請人的送達地址 : CHLOE LEE & CO.
 750] Applicant's Address for 1104 Tai Tung Building
 Service: 8 Fleming Road, Wanchai,
 HONG KONG

[511] 類別編號 : 9,12,36,38,39
 Class(es) No(s) .:

[511] 貨品/服務說明 : Class 12:
 Specification: Ships; cars; motorcycles; vans [vehicles];
 motor coaches; trucks; tricycles; bicycles;
 golf carts [vehicles]; tires for vehicle
 wheels; electric vehicles; gearing for land
 vehicles; civilian drones; delivery drones;
 aircraft.

[526] 卸棄 : N/A
 Disclaimer:

[529] 限制 : N/A
 Limitation:

[527] 條件 : N/A
 Condition:
 其他 : N/A
 Others

[220] 提交日期 : 31-08-2021
 Date of Filing:

[320]	[310]	[340]	[330]
聲稱具有優先權的日期:	優先權申請編號:	聲稱具有優先權 (部分):	優先權申請的
Date of Priority	Priority Application	Priority Claim	國家、地區、地方:
Claimed:	No.:	Details:	Country, territory,
			area of Priority
			Applications:
03-03-2021	40-2021-0042416	for Class 9	REPUBLIC OF KOREA
03-03-2021	40-2021-0042417	for Class 12	REPUBLIC OF KOREA
12-05-2021	40-2021-0098391	for Class 36	REPUBLIC OF KOREA
03-03-2021	40-2021-0042418	for Class 38	REPUBLIC OF KOREA
03-03-2021	40-2021-0042419	for Class 39	REPUBLIC OF KOREA

[210] 商標申請編號 : 305747617
 Application No.:

[540] 商標 :
Mark:

FlashBot

[550] 商標種類 :
Mark Type:
一系列商標 :
Series Mark:

一般商標
否

[571] 商標描述 :
Mark Description:

不適用

[730] 註冊申請人的姓名 / 名稱、地址 :
Applicant(s)'
Name, Address:

深圳市普渡科技有限公司 (Shenzhen Pudu Technology
Co., Ltd.)

中國

廣東省深圳市

南山區西麗街道西麗社區打石一路深圳國際創新谷 1 棟 A 座
501

[740/ 註冊申請人的送達地址 :
750] Applicant's Address for
Service:

香港凱旋知識產權代理有限公司

香港

九龍旺角煙廠街 9 號

興發商業大廈 7 樓 703 室

9, 12

[511] 類別編號 :
Class(es) No(s) .:

類別 12:

[511] 貨品 / 服務說明 :
Specification:

電動運載工具 ; 遙控運載工具 (非玩具) ; 陸、空、水或鐵路
用機動運載工具 ; 自動導向 (無人駕駛) 材料搬運車 ; 無人搬
運車 ; 救援用雪橇 ; 送貨用無人機 ; 空間運載工具 ; 水上運載
工具 ; 運載工具底盤 ; 陸地車輛馬達 ; 手推車 ; 運載工具用輪
胎 ; 運載工具用懸置減震器 ; 運載工具輪胎用防滑裝置 ; 運載
工具用剎車 ; 機器自動駕駛汽車 ; 無人駕駛汽車 ; 電動雙輪平
衡車 ; 運輸機器人 ; 無人駕駛運輸機器人 ; 自驅式運輸機器人
。

[526] 卸棄 :
Disclaimer:

不適用

[529] 限制 :
Limitation:

不適用

[527] 條件 :
Condition:

不適用

其他 :

不適用

Others

[220] 提交日期 :
Date of Filing:

16-09-2021

[320] 聲稱具有優先權的日期 :
Date of Priority Claimed:

不適用

- [310] 優先權申請編號 : 不適用
Priority Application Number:
- [340] 聲稱具有優先權 (部分) : 不適用
Priority Claim Details:
- [330] 優先權申請的 不適用
國家、地區、地方 :
Country, territory, area of
Priority Applications:

- [210] 商標申請編號 : 305754952
Application No.:

- [540] 商標 :
Mark:



- [550] 商標種類 : 一般商標
Mark Type:
一系列商標 : 否
Series Mark:

- [571] 商標描述 : 申請人聲稱紅色為商標的一個要素。
Mark Description:

- [730] 註冊申請人的姓名 / 名稱、地址 : 三鈴有限公司
Applicant(s) ' 香港
Name, Address: 柴灣祥利街 29 號
國貿中心 22 樓 2206 室
- [740/ 註冊申請人的送達地址 : 三鈴有限公司 Kelvin Lau
750] Applicant's Address for 香港
Service: 柴灣祥利街 29 號
國貿中心 22 樓 2206 室

- [511] 類別編號 : 12
Class(es) No(s) .:

- [511] 貨品 / 服務說明 : 類別 12:
Specification: 汽車 ; 電單車

- [526] 卸棄 : 不適用
Disclaimer:

- [529] 限制 : 不適用
Limitation:

- [527] 條件 : 不適用
Condition:
其他 : 不適用
Others

[220] 提交日期 : 24-09-2021
Date of Filing:

[320] 聲稱具有優先權的日期 : 不適用
Date of Priority Claimed:

[310] 優先權申請編號 : 不適用
Priority Application Number:

[340] 聲稱具有優先權 (部分) : 不適用
Priority Claim Details:

[330] 優先權申請的
國家、地區、地方 : 不適用
Country, territory, area of
Priority Applications:

[210] 商標申請編號 : 305754961
Application No.:

[540] 商標 :
Mark:



[550] 商標種類 : 一般商標
Mark Type:

一系列商標 : 否
Series Mark:

[571] 商標描述 : 申請人聲稱紅色為商標的一個要素。
Mark Description:

[730] 註冊申請人的姓名 / 名稱、地址 : 三鈴有限公司
Applicant(s) ' Name, Address: 香港
柴灣祥利街 29 號
國貿中心 22 樓 2206 室

[740/ 註冊申請人的送達地址 : 三鈴有限公司 Kelvin Lau
750] Applicant's Address for 香港
Service: 柴灣祥利街 29 號
國貿中心 22 樓 2206 室

[511] 類別編號 : 12
Class(es) No(s) .:

[511] 貨品 / 服務說明 : 類別 12:
Specification: 汽車 ; 電單車

[526] 卸棄 : 不適用
Disclaimer:

[529] 限制 : 不適用
Limitation:

[527] 條件 : 不適用
Condition:
其他 : 不適用
Others

[220] 提交日期 : 24-09-2021
Date of Filing:

[320] 聲稱具有優先權的日期 : 不適用
Date of Priority Claimed:

[310] 優先權申請編號 : 不適用
Priority Application Number:

[340] 聲稱具有優先權 (部分) : 不適用
Priority Claim Details:

[330] 優先權申請的
國家、地區、地方 : 不適用
Country, territory, area of
Priority Applications:

[210] 商標申請編號 : 305755834
Application No.:

[540] 商標 :
Mark:

HarmonySpace

[550] 商標種類 : Ordinary
Mark Type:
一系列商標 : NO
Series Mark:

[571] 商標描述 : N/A
Mark Description:

[730] 註冊申請人的姓名/名稱、地址 : Huawei Technologies Co., Ltd. (華為技術有限公司)
Applicant(s) ' Huawei Administration Building,
Name, Address: Bantian, Longgang District, Shenzhen,
Guangdong, 518129,
CHINA

[740/ 註冊申請人的送達地址 : UNITALEN ATTORNEYS AT LAW LIMITED
750] Applicant's Address for RM 1201, 12/F, GOLDEN ERA PLAZA,
Service: 39-55 SAI YEE ST, MONGKOK KLN,
HONG KONG

[511] 類別編號 : 9, 12, 42
Class(es) No(s) .:

[511] 貨品／服務說明：
Specification:

Class 12:
Self-generating electric locomotives [diesel-electric locomotives]; Electric vehicles; Remote control vehicles, other than toys; Electric cars; Motor cars; Gasoline engines for land vehicles; Reversing alarms for vehicles; Automobile dashboards; Doors for automobiles; Clutches for land vehicles; Anti-theft devices for land vehicles; Driverless cars [autonomous cars]; Automobile wheels; Engines for land vehicles; Electric motors for motor cars; Wheel hubs; Automobile windows; Car seats; Windscreens for motor cars; Mopeds; Self-balancing electric unicycles; Electrically powered scooters; self-balancing scooters; Push scooters [vehicles]; Bicycles; Electric wheelchairs; Tires for vehicle wheels; Repair outfits for inner tubes; Drones with aerial photography feature; Camera drones; Upholstery for vehicles; Safety seats for children, for vehicles; Seat covers for vehicles; Vehicle chassis; Windscreens for vehicles.

[526] 卸棄：
Disclaimer:

N/A

[529] 限制：
Limitation:

N/A

[527] 條件：
Condition:

N/A

其他：

N/A

Others

[220] 提交日期：
Date of Filing:

26-09-2021

[320] 聲稱具有優先權的日期：
Date of Priority Claimed:

[310] 優先權申請編號：
Priority Application No.:

[340] 聲稱具有優先權 (部分)：
Priority Claim Details:

[330] 優先權申請的
國家、地區、地方：
Country, territory, area of Priority Applications:

06-07-2021

57492590

for Class 09

CHINA

06-07-2021

57471550

for Class 12

CHINA

06-07-2021

57477444

for Class 42

CHINA

[210] 商標申請編號：
Application No.:

305762737

[540] 商標 :
Mark:



[550] 商標種類 : Ordinary
Mark Type:
一系列商標 : NO
Series Mark:

[571] 商標描述 : N/A
Mark Description:

[730] 註冊申請人的姓名 / 名稱、地址 : LSC Europe B.V.
Applicant(s) ' Westplein 55,
Name, Address: 3016 BM Rotterdam
NETHERLANDS

[740/ 註冊申請人的送達地址 : CHINAHONGKONG PATENT LIMITED
750] Applicant's Address for 1502, 15/F, Capital Centre,
Service: 151 Gloucester Road, Wanchai
HONG KONG

[511] 類別編號 : 12, 18
Class(es) No(s) .:

[511] 貨品 / 服務說明 : Class 12:
Specification: Strollers; baby strollers; aprons for
strollers; covers for (baby) strollers;
canopies for (baby) strollers; fitted
footmuffs for strollers; bags adapted for
strollers; car seats for babies and children;
aprons for car seats; covers for car seats;
sunshields for strollers; wind shields for
strollers; rain covers for strollers;
organizers specially adapted for use in/with
strollers and vehicles; cup holders for (use
in/with) strollers and vehicles; umbrella and
parasol holders for strollers and vehicles;
pushchairs for use with carry cots; wheeled
boards for use with strollers and carry cots;
aprons for wheeled carry cots and related
products and accessories for use with
strollers, car seats and wheeled carry cots.
Class 18:
Umbrellas and parasols (for use in/with
strollers); umbrella and parasol covers; bags
for umbrellas and parasols; frames for
umbrellas or parasols; diaper bags; leather
bags; travelling bags.

[526] 卸棄 : N/A
Disclaimer:

[529] 限制 : N/A
Limitation:

[527] 條件 : N/A
Condition:
其他 : N/A
Others

[220] 提交日期 : 30-09-2021
Date of Filing:

[320] 聲稱具有優先權的日期 : 31-03-2021
Date of Priority Claimed:

[310] 優先權申請編號 : 40202107479V
Priority Application Number:

[340] 聲稱具有優先權 (部分) : N/A
Priority Claim Details:

[330] 優先權申請的
國家、地區、地方 : SINGAPORE
Country, territory, area of
Priority Applications:

[210] 商標申請編號 : 305763312
Application No.:

[540] 商標 :
Mark:

Leclerc Baby

[550] 商標種類 : Ordinary
Mark Type:
一系列商標 : NO
Series Mark:

[571] 商標描述 : N/A
Mark Description:

[730] 註冊申請人的姓名 / 名稱、地址 : LSC Europe B.V.
Applicant(s) ' Westplein 55,
Name, Address: 3016 BM Rotterdam
NETHERLANDS

[740/ 註冊申請人的送達地址 : CHINAHONGKONG PATENT LIMITED
750] Applicant's Address for 1502, 15/F, Capital Centre,
Service: 151 Gloucester Road, Wanchai
HONG KONG

[511] 類別編號 : 12, 18
Class(es) No(s) .:

[511] 貨品 / 服務說明 : Class 12:
Specification: Strollers; baby strollers; aprons for
strollers; covers for (baby) strollers;
canopies for (baby) strollers; fitted
footmuffs for strollers; bags adapted for
strollers; car seats for babies and children;

aprons for car seats; covers for car seats; sunshields for strollers; wind shields for strollers; rain covers for strollers; organizers specially adapted for use in/with strollers and vehicles; cup holders for (use in/with) strollers and vehicles; umbrella and parasol holders for strollers and vehicles; pushchairs for use with carry cots; wheeled boards for use with strollers and carry cots; aprons for wheeled carry cots and related products and accessories for use with strollers, car seats and wheeled carry cots.
Class 18:

Umbrellas and parasols (for use in/with strollers); umbrella and parasol covers; bags for umbrellas and parasols; frames for umbrellas or parasols; diaper bags; leather bags; travelling bags.

- [526] 卸棄 : N/A
Disclaimer:
- [529] 限制 : N/A
Limitation:
- [527] 條件 : N/A
Condition:
其他 : N/A
Others
- [220] 提交日期 : 01-10-2021
Date of Filing:
- [320] 聲稱具有優先權的日期 : 01-04-2021
Date of Priority Claimed:
- [310] 優先權申請編號 : 40202107580V
Priority Application Number:
- [340] 聲稱具有優先權 (部分) : N/A
Priority Claim Details:
- [330] 優先權申請的 : SINGAPORE
國家、地區、地方 :
Country, territory, area of
Priority Applications:

-
- [210] 商標申請編號 : 305766021
Application No.:
- [540] 商標 :
Mark:
- [550] 商標種類 : Ordinary
Mark Type:

GARIA

一系列商標 : NO
Series Mark:

[571] 商標描述 : N/A
Mark Description:

[730] 註冊申請人的姓名 / 名稱、地址 : GARIA A/S
Applicant(s) ' Lunikvej 44B,
Name, Address: 2670 Greve,
DENMARK

[740/ 註冊申請人的送達地址 : WILKINSON & GRIST
750] Applicant's Address for 6th Floor, Prince's Building,
Service: Chater Road, Central,
HONG KONG

[511] 類別編號 : 12
Class(es) No(s) .:

[511] 貨品 / 服務說明 : Class 12:
Specification: Land vehicles; land vehicles, namely, golf cars, motorized golf carts, low-speed electric vehicles, low-speed electric utility vehicles, trucks, buses, vans, mini-dump trucks, electric mini-trucks, electric vans and electrically powered mini-buses; and electrically-powered motor vehicles.

[526] 卸棄 : N/A
Disclaimer:

[529] 限制 : N/A
Limitation:

[527] 條件 : N/A
Condition:
其他 : N/A
Others

[220] 提交日期 : 06-10-2021
Date of Filing:

[320] 聲稱具有優先權的日期 : N/A
Date of Priority Claimed:

[310] 優先權申請編號 : N/A
Priority Application Number:

[340] 聲稱具有優先權 (部分) : N/A
Priority Claim Details:

[330] 優先權申請的 N/A
國家、地區、地方 :
Country, territory, area of
Priority Applications:

[210] 商標申請編號 : 305766724
Application No.:

[540] 商標 :

LEXUS RZ450e

Mark:

- [550] 商標種類: Ordinary
Mark Type:
一系列商標: NO
Series Mark:
- [571] 商標描述: N/A
Mark Description:
- [730] 註冊申請人的姓名 / 名稱、地址: TOYOTA JIDOSHA KABUSHIKI KAISHA
Applicant(s) ' (also trading as TOYOTA MOTOR CORPORATION)
Name, Address: 1, Toyota-cho,
Toyota-shi, Aichi-ken,
JAPAN
- [740/ 註冊申請人的送達地址: CLT PATENT & TRADEMARK (H.K.) LIMITED
750] Applicant's Address for Unit 09, 34/F., Office Tower, Convention Plaza
Service: 1 Harbour Road, Wanchai
HONG KONG
- [511] 類別編號: 12
Class(es) No(s) .:
- [511] 貨品 / 服務說明: Class 12:
Specification: Automobiles and structural parts thereof.
- [526] 卸棄: N/A
Disclaimer:
- [529] 限制: N/A
Limitation:
- [527] 條件: N/A
Condition:
其他: N/A
Others
- [220] 提交日期: 07-10-2021
Date of Filing:
- [320] 聲稱具有優先權的日期: N/A
Date of Priority Claimed:
- [310] 優先權申請編號: N/A
Priority Application Number:
- [340] 聲稱具有優先權 (部分): N/A
Priority Claim Details:
- [330] 優先權申請的 N/A
國家、地區、地方:
Country, territory, area of
Priority Applications:
-
-
- [210] 商標申請編號: 305766733
Application No.:

[540] 商標：
Mark:

RZ450e

[550] 商標種類： Ordinary
Mark Type:
一系列商標： NO
Series Mark:

[571] 商標描述： N/A
Mark Description:

[730] 註冊申請人的姓名 / 名稱、地址： TOYOTA JIDOSHA KABUSHIKI KAISHA
Applicant(s) ' (also trading as TOYOTA MOTOR CORPORATION)
Name, Address: 1, Toyota-cho,
Toyota-shi, Aichi-ken,
JAPAN

[740/ 註冊申請人的送達地址： CLT PATENT & TRADEMARK (H.K.) LIMITED
750] Applicant's Address for Unit 09, 34/F., Office Tower, Convention Plaza
Service: 1 Harbour Road, Wanchai
HONG KONG

[511] 類別編號： 12
Class(es) No(s) .:

[511] 貨品 / 服務說明： Class 12:
Specification: Automobiles and structural parts thereof.

[526] 卸棄： N/A
Disclaimer:

[529] 限制： N/A
Limitation:

[527] 條件： N/A
Condition:
其他： N/A
Others

[220] 提交日期： 07-10-2021
Date of Filing:

[320] 聲稱具有優先權的日期： N/A
Date of Priority Claimed:

[310] 優先權申請編號： N/A
Priority Application Number:

[340] 聲稱具有優先權 (部分)： N/A
Priority Claim Details:

[330] 優先權申請的 N/A
國家、地區、地方：
Country, territory, area of
Priority Applications:

[210] 商標申請編號： 305773438
Application No.:

[540] 商標 :
Mark:

APRILIA RS660

[550] 商標種類 : Ordinary

Mark Type:

一系列商標 : NO

Series Mark:

[571] 商標描述 : N/A

Mark Description:

[730] 註冊申請人的姓名 / 名稱、地址 :

Piaggio & C. S.p.A.

Applicant(s)'

VIALE RINALDO PIAGGIO 25

Name, Address:

56025 PONTEDERA, PISA

ITALY

[740/ 註冊申請人的送達地址 :

DEACONS

750] Applicant's Address for Service:

5th Floor,

Alexandra House Central

HONG KONG

[511] 類別編號 :

12

Class(es) No(s) .:

[511] 貨品 / 服務說明 :

Class 12:

Specification:

Two-wheeled vehicles; electrically powered scooters; bodies for two-wheeled vehicles; brakes for two-wheeled vehicles; caps for gas tanks for two-wheeled vehicles; luggage nets for two-wheeled vehicles; shock absorbing springs for two-wheeled vehicles; suspension shock absorbers for two-wheeled vehicles; pneumatic tires for two-wheeled vehicles; casings for pneumatic tires for two-wheeled vehicles; non-skid devices for tires for two-wheeled vehicles; adhesive rubber patches for repairing inner tubes for two-wheeled vehicles; tire pumps for two-wheeled vehicles; repair outfits for inner tubes for two-wheeled vehicles; rims for wheels for two-wheeled vehicles; valves for vehicle tires; anti-theft devices for two-wheeled vehicles; anti-theft alarms for two-wheeled vehicles; horns for two-wheeled vehicles; safety seats for children for two-wheeled vehicles; stands for two-wheeled vehicles; mudguards for two-wheeled vehicles; direction signals for two-wheeled vehicles; frames for two-wheeled vehicles; luggage carriers for two-wheeled vehicles; pedals for two-wheeled vehicles; rear view mirrors for two-wheeled vehicles; saddle covers for two-wheeled vehicles; saddlebags adapted for two-wheeled vehicles; saddles for two-wheeled vehicles; engines for two-wheeled vehicles; electric motors for two-wheeled vehicles; two-wheeled vehicles' bags namely tank bags, sissy bar bags, tail bags, side hard bags, top cases.

[526]	卸棄： Disclaimer:	N/A
[529]	限制： Limitation:	N/A
[527]	條件： Condition:	N/A
	其他： Others	N/A
[220]	提交日期： Date of Filing:	15-10-2021
[320]	聲稱具有優先權的日期： Date of Priority Claimed:	N/A
[310]	優先權申請編號： Priority Application Number:	N/A
[340]	聲稱具有優先權 (部分)： Priority Claim Details:	N/A
[330]	優先權申請的 國家、地區、地方： Country, territory, area of Priority Applications:	N/A

類別 Class 14

- [210] 商標申請編號 : 305568337AA
Application No.:
- [540] 商標 :
Mark:
- WONDERLAB**
- [550] 商標種類 : Ordinary
Mark Type:
一系列商標 : NO
Series Mark:
- [571] 商標描述 : N/A
Mark Description:
- [730] 註冊申請人的姓名 / 名稱、地址 : Swarovski Aktiengesellschaft
Applicant (s) ' Dröschistrasse 15,
Name, Address: 9495 Triesen,
LIECHTENSTEIN
- [740/ 註冊申請人的送達地址 : BAKER & MCKENZIE
750] Applicant's Address for 14TH FLOOR, ONE TAIKOO PLACE,
Service: 979 KING'S ROAD, QUARRY BAY,
HONG KONG
- [511] 類別編號 : 14
Class(es) No(s) .:
- [511] 貨品 / 服務說明 : Class 14:
Specification: Precious metals and their alloys; jewellery,
precious and semi-precious stones; horological
and chronometric instruments; tiaras; hair
ornaments of precious metal (jewellery);
gemstones; synthetic precious stones;
imitation precious stones; jewellery stones of
faceted glass; ornaments (jewellery); magnets
being jewellery; necklaces; earrings;
bracelets; rings (jewellery); brooches;
bangles; jewellery charms; charms for key
rings; pendants; chains of precious and semi-
precious metals; chain belts being jewellery;
loquets; cuff links; tie pins and tie clips;
shoe clips being jewellery; scarf clips being
jewellery; medallions; key chains; key rings;
items of jewellery of glass, natural or
artificial precious stones, plastic, common or
precious metal for personal use; beads for
making jewellery; watches and clocks and their
parts; watch bands and straps; cases adapted
for holding watches and clocks; jewellery
cases; jewellery boxes.
- [526] 卸棄 : N/A
Disclaimer:
- [529] 限制 : N/A
Limitation:

[527] 條件 : N/A
Condition:
其他 : N/A
Others

[220] 提交日期 : 19-03-2021
Date of Filing:

[320] 聲稱具有優先權的日期 : 18-12-2020
Date of Priority Claimed:

[310] 優先權申請編號 : 2020-909
Priority Application Number:

[340] 聲稱具有優先權 (部分) : N/A
Priority Claim Details:

[330] 優先權申請的
國家、地區、地方 : LIECHTENSTEIN
Country, territory, area of
Priority Applications:

[210] 商標申請編號 : 305703020
Application No.:

[540] 商標 : **CECILIE BAHNSEN**
Mark:

[550] 商標種類 : Ordinary
Mark Type:
一系列商標 : NO
Series Mark:

[571] 商標描述 : N/A
Mark Description:

[730] 註冊申請人的姓名 / 名稱、地址 : Cecilie Bahnsen Holding ApS
Applicant(s) ' Rosenvængets Hovedvej 32, 1. tv.
Name, Address: 2100 Copenhagen Ø.
DENMARK

[740/ 註冊申請人的送達地址 : Rouse & Co. International (Overseas) Limited
750] Applicant's Address for 26/F., Tesbury Centre,
Service: 28 Queen's Road East
HONG KONG

[511] 類別編號 : 3, 9, 14, 24
Class(es) No(s) .:

[511] 貨品 / 服務說明 : Class 14:
Specification: Jewellery and precious metals and their
alloys, not included in other classes;
trinkets, jewellery and precious stones;
watches and clocks; watch straps.

[526] 卸棄 : N/A
Disclaimer:

[529] 限制 :	N/A
Limitation:	
[527] 條件 :	N/A
Condition:	
其他 :	N/A
Others	
[220] 提交日期 :	29-07-2021
Date of Filing:	
[320] 聲稱具有優先權的日期 :	N/A
Date of Priority Claimed:	
[310] 優先權申請編號 :	N/A
Priority Application Number:	
[340] 聲稱具有優先權 (部分) :	N/A
Priority Claim Details:	
[330] 優先權申請的 國家、地區、地方 :	N/A
Country, territory, area of Priority Applications:	
<hr/>	
[210] 商標申請編號 :	305709736
Application No.:	
[540] 商標 :	
Mark:	SANDRO FERRONE
[550] 商標種類 :	Ordinary
Mark Type:	
一系列商標 :	NO
Series Mark:	
[571] 商標描述 :	N/A
Mark Description:	
[730] 註冊申請人的姓名 / 名稱、地址 :	FERRONE S.P.A.
Applicant(s) ' Name, Address:	VIA TIBURTINA N. 1180 00156 ROMA ITALY
[740/ 註冊申請人的送達地址 :	WENPING PATENT & TRADE MARK AGENT LIMITED
750] Applicant's Address for Service:	1701 Tung Wai Commercial Building, 111 Gloucester Road, HONG KONG
[511] 類別編號 :	14,18,25
Class(es) No(s) .:	
[511] 貨品 / 服務說明 :	Class 14:
Specification:	Imitations jewellery ornaments; jewellery; silver jewelry; horological and chronometric instruments; amulets (jewellery); rings (jewellery); spun silver (silver wire); silver, unwrought or beaten; rings

(jewellery); bracelets (jewellery); busts of precious metal; chains (jewellery); charms (jewellery); Key rings (split rings with trinket or decorative fob); Jewelry cases (caskets or boxes); Necklaces (jewellery); chronographs (watches); chronometers; tie clips; Figurines of precious metal; jewellery findings; cuff links; cloisonné jewellery; jewellery of yellow amber; badges of precious metal; medals; medallions; precious metals, unwrought or semi-wrought; coins; works of art of precious metal; earrings; ornaments (jewellery); ornaments of jet; Shoe jewellery; hat ornaments of precious metal; gold, unwrought or beaten; Clocks; digital clocks; Mantle clocks; Desk clocks; table clocks; clocks; atomic clocks; wristwatches; clocks and watches, electric; pearls (jewellery); beads for making jewellery; semi-precious stones; precious stones; Key rings and key chains, and charms therefor; key rings (trinkets or fobs); Key fobs of imitation leather; Metal key fobs; key rings of leather; jewellery boxes; jewellery rolls; dials (clock- and watchmaking); sundials; boxes of precious metal; cases for timepieces; pins (jewellery); tie pins; ornamental pins; brooches (jewellery); statues of precious metal; paste jewellery; alarm clocks; watch glasses; Jewellery rope chain for anklets; Jewellery chain of precious metal for anklets; parts for clocks; Watch straps made of metal or leather or plastic; Jewellery findings; Fittings for watches; Paste jewellery; Personal jewellery; Articles of jewellery with ornamental stones; Jewellery made of plastics; Pewter jewellery; Crosses (jewellery); Jewellery for the head; Jewellery for personal adornment; Bracelets; bead bracelets; Cuff links; Plastic costume jewellery; cabochons; friendship bracelets; charity bracelets; Bracelets and watches combined; musical jewelry boxes; Chains (jewellery); prize cups of precious metal; Paste jewellery; Pet jewelry; Small clocks; Horological articles; retractable key rings; jewellery hat pins; trophies made of precious metal alloys; trophies of precious metal; trophies coated with precious metals; wooden bead bracelets; Wooden jewellery boxes.

Class 18:

Suitcases; Key cases ; travelling cases of leather; cases of imitation leather; Key cases; trunks (luggage); beauty case; luggage; carry-on bags; travel baggage; Combination walking sticks and umbrellas; Vanity cases,

not fitted; Handbags; Shoulder bags; Casual bags; Game bags (hunting accessories); Bags for campers; hiking bags; workbags; Wrist mounted carryall bags; Gym bags; Evening handbags; bags for sports; Travel baggage; travelling bags of imitation leather; Garment bags for travel made of leather; Travelling sets (leatherware); Shoe bags for travel; weekend bags; Canvas shopping bags; Garment carriers; Canvas bags; Diplomatic bags; Waterproof bags; bags of imitation leather; bags of leather; Saddlebags; Slouch handbags; all-purpose carrying bags; bags for sports clothing; Garment carriers; Towelling bags; courier bags; book bags; Bags for sports; Bags for umbrellas; Empty instrument cases for use by doctors; Roll bags; tool bags sold empty; Sporrans; Souvenir bags; tool bags, empty; small bags for men; key pouches; Hipsacks; multi-purpose purses (handbags); Handbags, purses and wallets; duffle bags for travel; holdalls for sports clothing; Pouches for holding make-up, keys and other personal items; travelling trunks; ; bags; shoulder bags; Children's shoulder bags ; beach bags; shopping bags; wheeled shopping bags; chain mesh purses; Small clutch purses; handbags; Hat boxes for travel; School bags; lockable straps for luggage; straps for luggage; saddle belts; Stirrup leathers; Shoulder straps; collars for animals; Coin holders ; leather for harnesses; leather for shoes; Imitation leather; Commutation-ticket holders; Business card cases; credit card cases; Tie cases; document holders (carrying cases); Folio cases; Carrying cases; bags for umbrellas; Covers for parasols; Clothing for pets; animal leashes; Business card cases; carriers for suits, shirts and dresses; Luggage covers; Overnight cases; school bags; briefcases; leatherboard; Cases of leather or leatherboard; Luggage tags; walking stick handles; hiking sticks; haversacks; umbrella handles; hip bags; Belt bags and hip bags; suitcase handles; slings for carrying infants; umbrellas and parasols; Credit card cases (wallets); Briefcases and attachè cases; Art portfolios (cases); folding briefcases; pocket wallets; Wallets of precious metal; wrist-mounted money purses; Cosmetic purses; Leather purses; business card cases; Card wallets (leatherware); Travelling sets; attaché cases; garment bags for travel; luggage, bags, wallets and carrying bags; Backpacks with wheels; trolley bags; rucksacks; daypacks; School knapsacks; Backpacks for carrying

infants; hiking rucksacks; Sling bags;
mountaineering rucksacks; sports packs;
Suitcases with wheels.

Class 25:

Clothing; waterproof clothing; Cashmere clothing; clothing of imitations of leather; clothing of leather; motorists' clothing; cyclists' clothing; clothing for gymnastics; dresses; jumper dresses; bath robes; non-slipping devices for footwear; bandanas (neckerchiefs); bibs, not of paper; stocking caps; berets; underwear; sweat-absorbent underwear; Nightwear; boas (necklets); bodies (clothing); braces for clothing (suspenders); corsets (underclothing); galoshes; skull caps; footwear; boots for sports; stockings; sweat-absorbent stockings; leotards; socks; breeches for wear; bathing trunks; albs; shirts; nightgowns; short-sleeve shirts; bodices (lingerie); sports singlets; hats; coats; hoods (clothing); belts (clothing); Flip-flops; money belts (clothing); tights; collars (clothing); detachable collars; camisoles; Headgear; layettes (clothing); bathing suits; masquerade costumes; beach clothes; neckties; bathing caps; shower caps; knickers; headbands (clothing); pocket squares; scarves; jackets (clothing); garters; Neck scarves (mufflers); stuff jackets (clothing); blousons; skirts; overalls; Jumper dresses; girdles; gloves (clothing); fingerless gloves; ready-made clothing; paper clothing; knitwear (clothing); kimonos; leggings (leg warmers); sports jerseys; hosiery; sweaters; muffs (clothing); pelerines; hairdressing capes; sleep masks; skorts; slips (underclothing); underpants; babies' pants (underwear); waistcoats; trousers; slippers; ear muffs (clothing); parkas; pelisses; pyjamas; ponchos; stocking suspenders; sock suspenders; brassieres; sandals; bath sandals; Neck tube scarves; footmuffs, not electrically heated; shoes; esparto shoes or sandals; bath slippers; gymnastic shoes; beach shoes; dress shoes; Footwear for men, women and children; Leisure shoes; sports shoes; slipper shoes; ski boots; shawls; Neck scarves (mufflers); inner soles; insoles for footwear; overcoats; outerclothing; petticoats; gaiter straps; Slips (underclothing); half-boots; lace boots; boots; fur stoles; tee-shirts; turbans; dressing gowns; Cap peaks; cap peaks; wooden shoes; clothing for children; clothing for boys; wind-resistant jackets; down jackets; Tracksuit bottoms; tracksuit tops; combinations (clothing); leisure wear; leisure

shoes; Down garments; Undershirts; Waterproof clothing ; rain pants; rubber boots; sports jackets; ankle-length pants; Snow suits; woollen clothing; clothing for women; women's suits; outerclothing for women; dresses for women; Women, men and children ceremonial dresses; Clothing for men, women and children; Bermuda shorts; Underwear; Gilets; Chemises; dress suits; men's suits; Shirts and slips; Baby bibs (not of paper); Beach clothes; Beach robes; Sandals and beach shoes; sun hats; neckerchiefs; babushkas (clothing); Headscarves; Snoods (scarves); beach wraps; Bath robes.

- [526] 卸棄 : N/A
Disclaimer:
- [529] 限制 : N/A
Limitation:
- [527] 條件 : N/A
Condition:
其他 : N/A
Others
- [220] 提交日期 : 06-08-2021
Date of Filing:
- [320] 聲稱具有優先權的日期 : N/A
Date of Priority Claimed:
- [310] 優先權申請編號 : N/A
Priority Application Number:
- [340] 聲稱具有優先權 (部分) : N/A
Priority Claim Details:
- [330] 優先權申請的
國家、地區、地方 : N/A
Country, territory, area of
Priority Applications:

- [210] 商標申請編號 : 305709934
Application No.:
- [540] 商標 : A
Mark:



B



- [550] 商標種類 : Ordinary
 Mark Type:
 一系列商標 : YES
 Series Mark:
- [571] 商標描述 : The applicant claims the colour blue as an
 Mark Description: element of mark "B" in the series.
- [730] 註冊申請人的姓名 / 名稱、地址 : ALGORDANZA LIMITED
 Applicant(s) ' 17th Floor, Supreme Commercial Building,
 Name, Address: 368 King's Road, North Point,
 HONG KONG
- [740/ 註冊申請人的送達地址 : STANDARD TRADEMARK REGISTRATION SERVICE
 750] Applicant's Address for LIMITED
 Service: Suite 503, Tower 2, Lippo Centre,
 Queensway,
 HONG KONG
- [511] 類別編號 : 14
 Class(es) No(s) .:
- [511] 貨品 / 服務說明 : Class 14:
 Specification: Jewellery; cremation jewellery; imitation
 jewellery; gemstones; diamonds; synthetic
 diamonds made from cremation ashes; jewellery
 cases.
- [526] 卸棄 : N/A
 Disclaimer:
- [529] 限制 : N/A
 Limitation:
- [527] 條件 : N/A
 Condition:
 其他 : By consent, No. 301352718
 Others
- [220] 提交日期 : 06-08-2021
 Date of Filing:
- [320] 聲稱具有優先權的日期 : N/A
 Date of Priority Claimed:
- [310] 優先權申請編號 : N/A
 Priority Application Number:
- [340] 聲稱具有優先權 (部分) : N/A
 Priority Claim Details:
- [330] 優先權申請的
 國家、地區、地方 : N/A
 Country, territory, area of
 Priority Applications:

[210] 商標申請編號 : 305720841

Application No.:

[540] 商標 :

Mark:

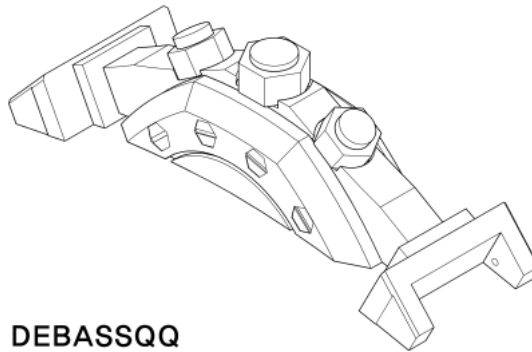

DEBASSQQ

Ordinary

[550] 商標種類 :

Mark Type:

一系列商標 :

Series Mark:

NO

[571] 商標描述 :

Mark Description:

N/A

[730] 註冊申請人的姓名 / 名稱、地址 :

Applicant (s) ' Name,Address:

JUNG, BAEKGYU

Room No.1 , Jeilvilla, Seogyong-ro 21na-gil 9,

Seongbuk-gu, Seoul,

REPUBLIC OF KOREA

[740/ 註冊申請人的送達地址 :

750] Applicant's Address for Service:

STANDARD TRADEMARK REGISTRATION SERVICE LIMITED

Suite 503, Tower 2, Lippo Centre,

Queensway,

HONG KONG

[511] 類別編號 :

Class(es) No(s) .:

14

[511] 貨品 / 服務說明 :

Specification:

Class 14:

Jewelry; rings [jewelry]; necklaces

[jewellery]; bracelets; earrings; pendants;

jewelry cases; watches; watch cases being part of watches; watch straps.

[526] 卸棄 :

Disclaimer:

N/A

[529] 限制 :

Limitation:

N/A

[527] 條件 :

Condition:

N/A

其他 :

Others

N/A

[220] 提交日期 :

Date of Filing:

18-08-2021

[320] 聲稱具有優先權的日期 :

Date of Priority Claimed:

N/A

[310] 優先權申請編號 :

N/A

Priority Application Number:

[340] 聲稱具有優先權 (部分): N/A

Priority Claim Details:

[330] 優先權申請的 N/A

國家、地區、地方:

Country, territory, area of

Priority Applications:

[210] 商標申請編號: 305720887

Application No.:

[540] 商標:

Mark:

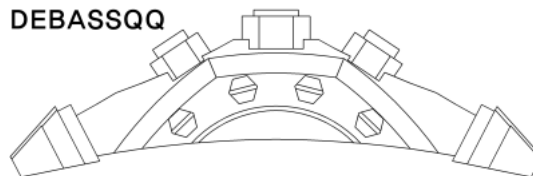
DEBASSQQ

[550] 商標種類: Ordinary

Mark Type:

一系列商標:

NO

Series Mark:

[571] 商標描述: N/A

Mark Description:

[730] 註冊申請人的姓名 / 名稱、地址:

Applicant(s) '

Name, Address:

JUNG, BAEKGYU

Room No.1 , Jeilvilla, Seogyong-ro 21na-gil
9,

Seongbuk-gu, Seoul,

REPUBLIC OF KOREA

[740/ 註冊申請人的送達地址:

750] Applicant's Address for
Service:STANDARD TRADEMARK REGISTRATION SERVICE
LIMITED

Suite 503, Tower 2, Lippo Centre,

Queensway,

HONG KONG

[511] 類別編號: 14

Class(es) No(s) .:

[511] 貨品 / 服務說明:

Specification:

Class 14:

Jewelry; rings [jewelry]; necklaces

[jewellery]; bracelets; earrings; pendants;

jewelry cases; watches; watch cases being part
of watches; watch straps.

[526] 卸棄: N/A

Disclaimer:

[529] 限制: N/A

Limitation:

[527] 條件: N/A

Condition:

其他:

N/A

Others

[220] 提交日期: 18-08-2021

Date of Filing:

[320] 聲稱具有優先權的日期 : N/A
Date of Priority Claimed:

[310] 優先權申請編號 : N/A
Priority Application Number:

[340] 聲稱具有優先權 (部分) : N/A
Priority Claim Details:

[330] 優先權申請的
國家、地區、地方 : N/A
Country, territory, area of
Priority Applications:

[210] 商標申請編號 : 305722209
Application No.:

[540] 商標 :
Mark:

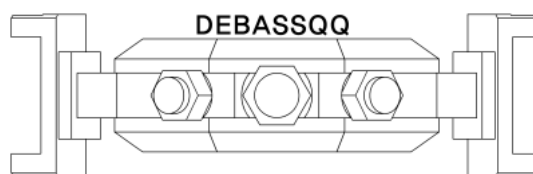

[550] 商標種類 : Ordinary
Mark Type:

一系列商標 : NO
Series Mark:

[571] 商標描述 : N/A
Mark Description:

[730] 註冊申請人的姓名 / 名稱、地址 : JUNG, BAEKGYU
Applicant(s) ' Room No.1 , Jeilvilla, Seogyong-ro 21na-gil
Name, Address: 9,
Seongbuk-gu, Seoul,
REPUBLIC OF KOREA

[740/ 註冊申請人的送達地址 : STANDARD TRADEMARK REGISTRATION SERVICE
750] Applicant's Address for LIMITED
Service: Suite 503, Tower 2, Lippo Centre,
Queensway,
HONG KONG

[511] 類別編號 : 14
Class(es) No(s).:

[511] 貨品 / 服務說明 : Class 14:
Specification: Jewelry; rings [jewelry]; necklaces
[jewellery]; bracelets; earrings; pendants;
jewelry cases; watches; watch cases being part
of watches; watch straps.

[526] 卸棄 : N/A
Disclaimer:

[529] 限制 : N/A
Limitation:

[527] 條件 : N/A
Condition:

其他 : N/A

Others

- [220] 提交日期: 19-08-2021
Date of Filing:
- [320] 聲稱具有優先權的日期: N/A
Date of Priority Claimed:
- [310] 優先權申請編號: N/A
Priority Application Number:
- [340] 聲稱具有優先權 (部分): N/A
Priority Claim Details:
- [330] 優先權申請的
國家、地區、地方: N/A
Country, territory, area of
Priority Applications:

- [210] 商標申請編號: 305723299
Application No.:
- [540] 商標: A
Mark:



B



- [550] 商標種類: 一般商標
Mark Type:
- 一系列商標: 是

Series Mark:

- [571] 商標描述 :
Mark Description: 在本系列商標中的商標"A", 申請人聲稱紅色, 黑色及白色為商標的多於一個要素; 在商標"B", 申請人聲稱金色及白色為商標的多於一個要素。
- [730] 註冊申請人的姓名 / 名稱、地址 :
Applicant(s) ' Name, Address: 臻琦珠寶有限公司 (JOYCHY LIMITED)
香港
九龍旺角上海街 422-426 號
萬事昌中心 13 樓 1301 室
- [740/ 註冊申請人的送達地址 :
750] Applicant's Address for Service: 臻琦珠寶有限公司 (JOYCHY LIMITED)
香港
九龍旺角上海街 422-426 號
萬事昌中心 13 樓 1301 室
- [511] 類別編號 :
Class(es) No(s) .: 14
- [511] 貨品 / 服務說明 :
Specification: 類別 14:
貴金屬及其合金; 首飾, 寶石和半寶石; 鐘錶和計時儀器。
- [526] 卸棄 :
Disclaimer: 不適用
- [529] 限制 :
Limitation: 不適用
- [527] 條件 :
Condition: 不適用
- 其他 :
Others: 不適用
- [220] 提交日期 :
Date of Filing: 20-08-2021
- [320] 聲稱具有優先權的日期 :
Date of Priority Claimed: 不適用
- [310] 優先權申請編號 :
Priority Application Number: 不適用
- [340] 聲稱具有優先權 (部分) :
Priority Claim Details: 不適用
- [330] 優先權申請的
國家、地區、地方 :
Country, territory, area of Priority Applications: 不適用
-
- [210] 商標申請編號 :
Application No.: 305725567

[540] 商標：
Mark:



HONG KONG ASSOCIATION
OF JEWELRY LIMITED

香港廠商珠寶有限公司

- [550] 商標種類： 一般商標
Mark Type:
一系列商標： 否
Series Mark:
- [571] 商標描述： 不適用
Mark Description:
- [730] 註冊申請人的姓名 / 名稱、地址： 香港廠商珠寶有限公司 (HONG KONG ASSOCIATION OF
Applicant(s) ' JEWELRY LIMITED)
Name, Address: 香港
九龍紅磡民裕街 36 號
榮業大廈 12 樓 E3 室
- [740/ 註冊申請人的送達地址： 優勤商業方案公司 (ICAN BUSINESS SOLUTIONS
750] Applicant's Address for COMPANY)
Service: 香港
九龍尖沙咀廣東道 28 號
力寶太陽廣場 11 樓 1101B 室
- [511] 類別編號： 14, 35
Class(es) No(s) .:
- [511] 貨品 / 服務說明： 類別 14：
Specification: 貴重金屬及其合金以及不屬別類的貴金屬製品或鍍有貴重金屬
的物品、珠寶、首飾、寶石、鐘錶和計時儀器。
類別 35：
貴重金屬及其合金以及貴金屬製品或鍍有貴重金屬的物品、珠
寶、首飾、寶石、鐘錶和計時儀器之銷售服務。
- [526] 卸棄： 不適用
Disclaimer:
- [529] 限制： 不適用
Limitation:
- [527] 條件： 不適用
Condition:
其他： 不適用
Others

[220] 提交日期: 23-08-2021
Date of Filing:

[320] 聲稱具有優先權的日期: 不適用
Date of Priority Claimed:

[310] 優先權申請編號: 不適用
Priority Application Number:

[340] 聲稱具有優先權 (部分): 不適用
Priority Claim Details:

[330] 優先權申請的
國家、地區、地方: 不適用
Country, territory, area of
Priority Applications:

[210] 商標申請編號: 305727916
Application No.:

[540] 商標:
Mark:

A

The image shows the trademark 'FWEN CLUB' in a bold, black, sans-serif font. The letters are thick and blocky, with a slightly irregular, hand-drawn appearance. The 'W' and 'E' are particularly prominent.

B

The image shows the trademark 'FWEN CLUB' in a bold, black, sans-serif font, similar to version A but with a slightly different layout and spacing. The letters are thick and blocky, with a slightly irregular, hand-drawn appearance. The 'W' and 'E' are particularly prominent.

[550] 商標種類: Ordinary
Mark Type:

一系列商標: YES
Series Mark:

[571] 商標描述: N/A
Mark Description:

[730] 註冊申請人的姓名 / 名稱、地址: Dong Doi Tung Limited (當代通有限公司)
Applicant(s) ' 12/F, Hang Wai Commercial Building,
Name, Address: 231-233 Queen's Road East, Wanchai,
HONG KONG

[740/ 註冊申請人的送達地址 : ROBIN BRIDGE & JOHN LIU
750] Applicant's Address for 6th Floor, Emperor Commercial Centre,
Service: 39 Des Voeux Road Central,
HONG KONG

[511] 類別編號 : 6, 9, 11, 14, 16, 18, 20, 21, 24, 25, 28, 35, 36, 41, 42, 45
Class(es) No(s) .:

[511] 貨品 / 服務說明 : Class 14:
Specification: Works of art of precious metal; works of art
of precious stones and diamonds; works of art
of silver; sculptures of precious metal;
statues and figurines (statuettes) of precious
metal; figurines of precious stones; goods
made of precious metals or coated therewith,
not included in other classes; boxes of
precious metal; trophies of precious metal;
badges of precious metal; coins of precious
metal; coins; medals; commemorative cups of
precious metal; key chains [split rings with
trinket or decorative fob]; key rings [split
rings with trinket or decorative fob];
ornamental pins; pins of precious metal; tie
clips; precious metals and their alloys;
natural and artificial precious stones; semi-
precious stones; imitation precious stones;
precious stones and articles made thereof;
jewelry; ornaments (jewellery); imitation
jewellery; decorative pins (jewellery); charms
for jewellery; cuff links; horological and
chronometric instruments; clocks; watches;
timepieces; alarm clocks; boxes for jewellery;
boxes for time pieces; cases for jewellery;
cases for timepieces.

[526] 卸棄 : N/A
Disclaimer:

[529] 限制 : N/A
Limitation:

[527] 條件 : N/A
Condition:
其他 : N/A
Others

[220] 提交日期 : 25-08-2021
Date of Filing:

[320] 聲稱具有優先權的日期 : N/A
Date of Priority Claimed:

[310] 優先權申請編號 : N/A
Priority Application Number:

[340] 聲稱具有優先權 (部分) : N/A
Priority Claim Details:

[330] 優先權申請的 N/A
國家、地區、地方 :
Country, territory, area of
Priority Applications:

[210]	商標申請編號 : Application No.:	305729202
[540]	商標 : Mark:	
[550]	商標種類 : Mark Type:	Ordinary
	一系列商標 : Series Mark:	NO
[571]	商標描述 : Mark Description:	N/A
[730]	註冊申請人的姓名 / 名稱、地址 : Applicant(s) ' Name, Address:	Golden Concept AB Baltzargatan 20 21136, Malmö, SWEDEN
[740/750]	註冊申請人的送達地址 : Applicant's Address for Service:	CHINA PATENT AGENT (HONG KONG) LIMITED 22/F, Great Eagle Centre, 23 Harbour Road, Wanchai, HONG KONG
[511]	類別編號 : Class(es) No(s) .:	9, 14, 18, 25
[511]	貨品 / 服務說明 : Specification:	Class 14: Jewelry; bracelets (jewellery); rings (jewellery); decorative pins (jewellery); medallions (jewellery); chains (jewellery); necklaces (jewellery); amulets (jewellery); jewellery made of precious stones; jewellery made of precious metal alloys; jewellery, including imitation jewellery and plastic jewellery; jewellery, clocks and watches; jewellery made of precious metals; jewellery made of non-precious metals; jewellery coated with precious metals; key chains as jewellery (trinkets or fobs); earrings; straps for wristwatches.
[526]	卸棄 : Disclaimer:	N/A
[529]	限制 : Limitation:	N/A
[527]	條件 : Condition:	N/A
	其他 : Others	N/A
[220]	提交日期 : Date of Filing:	26-08-2021
[320]	聲稱具有優先權的日期 :	N/A

Date of Priority Claimed:

- [310] 優先權申請編號: N/A
Priority Application Number:
- [340] 聲稱具有優先權 (部分): N/A
Priority Claim Details:
- [330] 優先權申請的
國家、地區、地方: N/A
Country, territory, area of
Priority Applications:

- [210] 商標申請編號: 305730435
Application No.:

- [540] 商標:
Mark:

MOOCHIES

- [550] 商標種類: Ordinary
Mark Type:
- 一系列商標: NO
Series Mark:

- [571] 商標描述: N/A
Mark Description:

- [730] 註冊申請人的姓名 / 名稱、地址: Moochies Technologies Limited
Applicant(s) ' 159 Wardour Street,
Name, Address: London W1F 8WH,
UNITED KINGDOM

- [740/ 註冊申請人的送達地址: RIBEIRO HUI
750] Applicant's Address for 6/F, Wilson House,
Service: 19-27 Wyndham Street, Central
HONG KONG

- [511] 類別編號: 9, 14, 35, 38
Class(es) No(s) .:

- [511] 貨品 / 服務說明: Class 14:
Specification: Watches; watch bands; watch straps; parts for
watches.

- [526] 卸棄: N/A
Disclaimer:

- [529] 限制: N/A
Limitation:

- [527] 條件: N/A
Condition:

- 其他: N/A
Others

- [220] 提交日期: 27-08-2021
Date of Filing:

- [320] 聲稱具有優先權的日期: 19-08-2021

Date of Priority Claimed:
[310] 優先權申請編號: UK00003683782
Priority Application Number:
[340] 聲稱具有優先權 (部分): N/A
Priority Claim Details:
[330] 優先權申請的 UNITED KINGDOM
國家、地區、地方:
Country, territory, area of
Priority Applications:

[210] 商標申請編號: 305732136
Application No.:
[540] 商標: **JOHNNY JANE**
Mark:
[550] 商標種類: Ordinary
Mark Type:
一系列商標: NO
Series Mark:
[571] 商標描述: N/A
Mark Description:
[730] 註冊申請人的姓名 / 名稱、地址: JANE'S ARMOR, LLC
Applicant(s) ' c/o Keats Gatien, LLP
Name, Address: 120 S. El Camino Drive, Suite 207
Beverly Hills, CA 90212
UNITED STATES OF AMERICA
[740/ 註冊申請人的送達地址: SIMONE INTELLECTUAL PROPERTY SERVICES ASIA
750] Applicant's Address for LIMITED
Service: 25th Floor, 3 Lockhart Road,
Wanchai,
HONG KONG
[511] 類別編號: 3, 14, 18, 25, 35
Class(es) No(s) . .:
[511] 貨品 / 服務說明: Class 14:
Specification: Jewelry; precious metals and their alloys;
precious and semi-precious stones; horological
and chronometric instruments.
[526] 卸棄: N/A
Disclaimer:
[529] 限制: N/A
Limitation:
[527] 條件: N/A
Condition:
其他: N/A
Others

[220] 提交日期 : 30-08-2021
Date of Filing:
[320] 聲稱具有優先權的日期 : N/A
Date of Priority Claimed:
[310] 優先權申請編號 : N/A
Priority Application Number:
[340] 聲稱具有優先權 (部分) : N/A
Priority Claim Details:
[330] 優先權申請的
國家、地區、地方 : N/A
Country, territory, area of
Priority Applications:

[210] 商標申請編號 : 305736411
Application No.:

[540] 商標 :
Mark:

路威酩軒

[550] 商標種類 : Ordinary
Mark Type:
一系列商標 : NO
Series Mark:

[571] 商標描述 : N/A
Mark Description:

[730] 註冊申請人的姓名 / 名稱、地址 : LVMH Moët Hennessy Louis Vuitton
Applicant(s) ' 22 avenue Montaigne
Name, Address: 75008 PARIS
FRANCE

[740/ 註冊申請人的送達地址 : LETTERS & THOO LIMITED
750] Applicant's Address for Suite 1008, Prosperity Millennia Plaza,
Service: 663 King's Road, Quarry Bay
HONG KONG

[511] 類別編號 : 3, 9, 14, 18, 25, 32, 33, 35
Class(es) No(s) .:

[511] 貨品 / 服務說明 : Class 14:
Specification: Jewelry; jewelry products, precious stones;
timepieces and chronometric instruments;
precious metals and their alloys; works of art
of precious metal; jewelry cases [caskets];
boxes of precious metal; watch cases, straps,
chains, springs or glasses; key rings
[trinkets or fobs]; statues or figurines
(statuettes) of precious metals; cases or
presentation cases for timepieces; medals;
cuff links; tie pins.

[526] 卸棄 : N/A
Disclaimer:

[529] 限制 : N/A
Limitation:

[527] 條件 : N/A
Condition:
其他 : N/A
Others

[220] 提交日期 : 03-09-2021
Date of Filing:

[320] 聲稱具有優先權的日期 : N/A
Date of Priority Claimed:

[310] 優先權申請編號 : N/A
Priority Application Number:

[340] 聲稱具有優先權 (部分) : N/A
Priority Claim Details:

[330] 優先權申請的
國家、地區、地方 : N/A
Country, territory, area of
Priority Applications:

[210] 商標申請編號 : 305736475
Application No.:

[540] 商標 :
Mark:

Power Engine

[550] 商標種類 : Ordinary
Mark Type:
一系列商標 : NO
Series Mark:

[571] 商標描述 : N/A
Mark Description:

[730] 註冊申請人的姓名 / 名稱、地址 : Citizen Tokei Kabushiki Kaisha also trading as
Applicant(s) ' Citizen Watch Co., Ltd.
Name, Address: 1-12, 6-chome, Tanashi-cho,
Nishi-tokyo-shi, Tokyo,
JAPAN

[740/ 註冊申請人的送達地址 : WILKINSON & GRIST
750] Applicant's Address for 6th Floor, Prince's Building
Service: Chater Road, Central
HONG KONG

[511] 類別編號 : 14
Class(es) No(s).:

[511] 貨品 / 服務說明 : Class 14:
Specification: Watches, clocks, movements for watches, and
parts and fittings thereof.

[526] 卸棄: N/A
Disclaimer:

[529] 限制: N/A
Limitation:

[527] 條件: N/A
Condition:
其他: N/A
Others

[220] 提交日期: 03-09-2021
Date of Filing:

[320] 聲稱具有優先權的日期: N/A
Date of Priority Claimed:

[310] 優先權申請編號: N/A
Priority Application Number:

[340] 聲稱具有優先權 (部分): N/A
Priority Claim Details:

[330] 優先權申請的
國家、地區、地方: N/A
Country, territory, area of
Priority Applications:

[210] 商標申請編號: 305737627
Application No.:

[540] 商標: A
Mark:



B



[550] 商標種類: Ordinary
Mark Type:
一系列商標: YES
Series Mark:

- [571] 商標描述 : N/A
Mark Description:
- [730] 註冊申請人的姓名 / 名稱、地址 : West Kowloon Cultural District Authority
Applicant(s) ' WKCDA Tower, West Kowloon Cultural District,
Name, Address: No. 8 Austin Road West, Kowloon
HONG KONG
- [740/ 註冊申請人的送達地址 : HOGAN LOVELLS
750] Applicant's Address for 11th Floor, One Pacific Place
Service: 88 Queensway
HONG KONG
- [511] 類別編號 : 2, 3, 4, 8, 9, 11, 14, 16, 18, 20, 21, 22, 23, 24, 25, 26, 27,
Class(es) No(s) .: 28, 29, 30, 32, 33, 35, 39, 41, 43
- [511] 貨品 / 服務說明 : Class 14:
Specification: Clocks and watches; coins; cuff links;
earrings; figurines of precious metal;
jewellery; pearls [jewellery]; key rings;
ornamental pins; tie clips; trinkets; precious
metals and their alloys; precious and semi-
precious stones; horological and chronometric
instruments.
- [526] 卸棄 : N/A
Disclaimer:
- [529] 限制 : N/A
Limitation:
- [527] 條件 : N/A
Condition:
- 其他 : N/A
Others
- [220] 提交日期 : 06-09-2021
Date of Filing:
- [320] 聲稱具有優先權的日期 : N/A
Date of Priority Claimed:
- [310] 優先權申請編號 : N/A
Priority Application Number:
- [340] 聲稱具有優先權 (部分) : N/A
Priority Claim Details:
- [330] 優先權申請的 N/A
國家、地區、地方 :
Country, territory, area of
Priority Applications:
-
-

- [210] 商標申請編號 : 305741929
Application No.:

[540] 商標：
Mark:

M E E T Y O U
遇见你 . 只为你

[550] 商標種類： 一般商標
Mark Type:
一系列商標： 否
Series Mark:

[571] 商標描述： 不適用
Mark Description:

[730] 註冊申請人的姓名 / 名稱、地址： 黃有強
Applicant(s) ' 中國
Name, Address: 河南省濟源市
大峪鎮三岔河村

[740/ 註冊申請人的送達地址： 香港銘煥知識產權有限公司
750] Applicant's Address for 香港
Service: 九龍灣宏開道 16 號
德福大廈 13 樓 12 室

[511] 類別編號： 14
Class(es) No(s) .:

[511] 貨品 / 服務說明： 類別 14:
Specification: 未加工或半加工貴金屬；貴金屬合金；未加工、未打造的銀；
首飾盒；首飾包；首飾用禮品盒；瑪瑙；首飾用小飾物；手鐲
(首飾)；項鍊(首飾)；珠寶首飾；寶石；人造珠寶；戒指
(首飾)；貴金屬制藝術品；耳環；別針(首飾)；制首飾用
珠子；念珠；翡翠；玉雕首飾；錶；錶帶；錶發條；錶針；鐘
錶機芯；錶用禮品盒；首飾配件；領帶飾針

[526] 卸棄： 不適用
Disclaimer:

[529] 限制： 不適用
Limitation:

[527] 條件： 不適用
Condition:

其他 : 不適用
Others

[220] 提交日期 : 09-09-2021
Date of Filing:

[320] 聲稱具有優先權的日期 : 不適用
Date of Priority Claimed:

[310] 優先權申請編號 : 不適用
Priority Application Number:

[340] 聲稱具有優先權 (部分) : 不適用
Priority Claim Details:

[330] 優先權申請的
國家、地區、地方 : 不適用
Country, territory, area of
Priority Applications:

[210] 商標申請編號 : 305742487
Application No.:

[540] 商標 : MARVELOUS CREATIONS BY HARRY WINSTON
Mark:

[550] 商標種類 : Ordinary
Mark Type:
一系列商標 : NO
Series Mark:

[571] 商標描述 : N/A
Mark Description:

[730] 註冊申請人的姓名 / 名稱、地址 : Harry Winston, Inc.
Applicant(s) ' 718 Fifth Avenue
Name, Address: NY10019 New York
UNITED STATES OF AMERICA

[740/ 註冊申請人的送達地址 : SIMONE INTELLECTUAL PROPERTY SERVICES ASIA
750] Applicant's Address for LIMITED
Service: 25th Floor, 3 Lockhart Road,
Wanchai,
HONG KONG

[511] 類別編號 : 14
Class(es) No(s) .:

[511] 貨品 / 服務說明 : Class 14:
Specification: Precious metals and their alloys and goods
made of these materials or coated therewith
included in this class namely figurines,
trophies; jewelry namely rings, earrings,
cufflinks, bracelets, charms, brooches,
chains, necklaces, tie pins, tie clips,
jewelry boxes, jewelry cases; precious stones,
semi-precious stones (fine stones);
horological and chronometric instruments

namely chronometers, chronographs, clocks, watches, bracelets, pendulums, alarm clocks as well as parts and accessories for the aforesaid goods, namely hands, anchors, pendulums, barrels, watch cases, watch straps, watch dials, watch frames, watch chains, watch movements, watch springs, watch glasses, watch cases, watch boxes.

- [526] 卸棄 : N/A
Disclaimer:
- [529] 限制 : N/A
Limitation:
- [527] 條件 : N/A
Condition:
其他 : N/A
Others
- [220] 提交日期 : 10-09-2021
Date of Filing:
- [320] 聲稱具有優先權的日期 : 15-07-2021
Date of Priority Claimed:
- [310] 優先權申請編號 : 11171/2021
Priority Application Number:
- [340] 聲稱具有優先權 (部分) : N/A
Priority Claim Details:
- [330] 優先權申請的
國家、地區、地方 : SWITZERLAND
Country, territory, area of
Priority Applications:

-
- [210] 商標申請編號 : 305744133
Application No.:

- [540] 商標 :
Mark:

VAZANA

- [550] 商標種類 : Ordinary
Mark Type:
一系列商標 : NO
Series Mark:

- [571] 商標描述 : N/A
Mark Description:

- [730] 註冊申請人的姓名 / 名稱、地址 : Vazana Limited
Applicant(s) ' Room H, 12/F, Valiant Industrial Centre
Name, Address: 2-12 Au Pui Wan Street Fo Tan,
HONG KONG

[740/ 註冊申請人的送達地址 : Vazana Limited
750] Applicant's Address for Room H, 12/F, Valiant Industrial Centre
Service: 2-12 Au Pui Wan Street, Fo Tan
HONG KONG

[511] 類別編號 : 14
Class(es) No(s) .: 14

[511] 貨品 / 服務說明 : Class 14:
Specification: Jewellery, precious and semi-precious stones;
precious metals and their alloys.

[526] 卸棄 : N/A
Disclaimer:

[529] 限制 : N/A
Limitation:

[527] 條件 : N/A
Condition:
其他 : N/A
Others

[220] 提交日期 : 13-09-2021
Date of Filing:

[320] 聲稱具有優先權的日期 : N/A
Date of Priority Claimed:

[310] 優先權申請編號 : N/A
Priority Application Number:

[340] 聲稱具有優先權 (部分) : N/A
Priority Claim Details:

[330] 優先權申請的 N/A
國家、地區、地方 :
Country, territory, area of
Priority Applications:

[210] 商標申請編號 : 305744926
Application No.:

[540] 商標 :
Mark:



[550] 商標種類 : 一般商標
Mark Type:
一系列商標 : 否
Series Mark:

- [571] 商標描述 : 不適用
Mark Description:
- [730] 註冊申請人的姓名 / 名稱、地址 : 廖淑君、陳煒霖及陳仲婷以尚鑽珠寶之名營業
Applicant(s) ' 香港
Name, Address: 尖沙咀金馬倫道 48 號
中國保險大廈 14 樓 01A 室
- [740/ 註冊申請人的送達地址 : 廖淑君
750] Applicant's Address for 香港
Service: 尖沙咀金馬倫道 48 號
中國保險大廈 14 樓 01A 室
- [511] 類別編號 : 14, 16
Class(es) No(s) .:
- [511] 貨品 / 服務說明 : 類別 14:
Specification: 貴金屬及其合金 ; 首飾 , 寶石和半寶石 ; 鐘錶和計時儀器。
類別 16:
紙和紙板 ; 印刷品 ; 書籍裝訂材料 ; 照片 ; 文具和辦公用品 (傢具除外) ; 文具用或家庭用黏合劑 ; 繪畫材料和藝術家用材料 ; 畫筆 ; 教育或教學用品 ; 包裝和打包用塑料紙、塑料膜和塑料袋 ; 印刷鉛字 , 印版。
- [526] 卸棄 : 不適用
Disclaimer:
- [529] 限制 : 不適用
Limitation:
- [527] 條件 : 不適用
Condition:
其他 : 不適用
Others
- [220] 提交日期 : 14-09-2021
Date of Filing:
- [320] 聲稱具有優先權的日期 : 不適用
Date of Priority Claimed:
- [310] 優先權申請編號 : 不適用
Priority Application Number:
- [340] 聲稱具有優先權 (部分) : 不適用
Priority Claim Details:
- [330] 優先權申請的 不適用
國家、地區、地方 :
Country, territory, area of
Priority Applications:
-
- [210] 商標申請編號 : 305746267
Application No.:

[540] 商標 :

Mark:

VUITTON

[550] 商標種類 :

Ordinary

Mark Type:

一系列商標 :

NO

Series Mark:

[571] 商標描述 :

N/A

Mark Description:

[730] 註冊申請人的姓名 / 名稱、地址 :

LOUIS VUITTON MALLETIER

Applicant(s)'

2, RUE DU PONT-NEUF,

Name, Address:

75001 PARIS,

FRANCE

[740/ 註冊申請人的送達地址 :

BAKER & MCKENZIE

750] Applicant's Address for

14TH FLOOR, ONE TAIKOO PLACE,

Service:

979 KING'S ROAD, QUARRY BAY,

HONG KONG

[511] 類別編號 :

9, 14, 18, 25

Class(es) No(s) .:

[511] 貨品 / 服務說明 :

Class 14:

Specification:

Jewellery; rings [jewellery]; earrings; cuff links; bracelets [jewellery]; bracelets made of embroidered textile [jewellery]; jewellery charms; brooches [jewellery]; chains [jewellery]; necklaces [jewellery]; pendants [jewellery]; lockets [jewellery]; amulets [jewellery]; presentation boxes for jewellery; pins [jewellery]; tie pins; tie clips; jewellery boxes; boxes of precious metal and their alloys; medals; pearls [jewellery]; semi-precious stones; precious stones; diamonds; bags charms; charms for key rings; key rings [split rings with trinket or decorative fob]; statues of precious metal and their alloys; works of art of precious metal and their alloys; figurines and statuettes of precious metal; horological instruments; watches; wristwatches; watch straps; watch cases [parts of watches]; dials [clock and watchmaking]; watch chains; chronometers; presentation boxes for watches; clocks; alarm clocks; chronometric instruments; movements for clocks and watches.

[526] 卸棄 :

N/A

Disclaimer:

[529] 限制 :

N/A

Limitation:

[527] 條件 :

N/A

Condition:

其他 :

N/A

Others

[220] 提交日期 : 15-09-2021
Date of Filing:
[320] 聲稱具有優先權的日期 : N/A
Date of Priority Claimed:
[310] 優先權申請編號 : N/A
Priority Application Number:
[340] 聲稱具有優先權 (部分) : N/A
Priority Claim Details:
[330] 優先權申請的 : N/A
國家、地區、地方 :
Country, territory, area of
Priority Applications:

[210] 商標申請編號 : 305746357
Application No.:
[540] 商標 :
Mark:

PANDORA
FOR EVERY STORY

[550] 商標種類 : Ordinary
Mark Type:
一系列商標 : NO
Series Mark:
[571] 商標描述 : N/A
Mark Description:
[730] 註冊申請人的姓名 / 名稱、地址 : Pandora A/S
Applicant(s) ' Havneholmen 17-19
Name, Address: 1561 Copenhagen V
DENMARK
[740/ 註冊申請人的送達地址 : ELLALAN
750] Applicant's Address for 26th and 28th Floors, The Hennessy,
Service: 256 Hennessy Road, Wanchai,
HONG KONG
[511] 類別編號 : 14
Class(es) No(s) . :
[511] 貨品 / 服務說明 : Class 14:
Specification: Precious metals and their alloys; jewellery;
precious and semi-precious stones; horological
and chronometric instruments; paste jewellery;
jewellery made of precious metals, gemstones,
pearls, natural or artificial precious or
semi-precious stones and imitations thereof;

cuff links; ornamental pins; watches; watch straps; watch chains; cases for jewellery and watches; charms for key rings; key rings; key chains; clasps for jewellery; jewellery boxes; tie pins; tie clips; jewel pendants; trinkets [jewellery]; ornaments [jewellery]; shoe jewellery; pet jewellery; key chains as jewellery [trinkets or fobs]; dress and bag ornaments in the nature of jewellery; decorative articles [trinkets or jewellery] for personal use; charms for watches.

- [526] 卸棄 : N/A
Disclaimer:
- [529] 限制 : N/A
Limitation:
- [527] 條件 : N/A
Condition:
其他 : N/A
Others
- [220] 提交日期 : 15-09-2021
Date of Filing:
- [320] 聲稱具有優先權的日期 : N/A
Date of Priority Claimed:
- [310] 優先權申請編號 : N/A
Priority Application Number:
- [340] 聲稱具有優先權 (部分) : N/A
Priority Claim Details:
- [330] 優先權申請的
國家、地區、地方 : N/A
Country, territory, area of
Priority Applications:
-
-

- [210] 商標申請編號 : 305748012
Application No.:
- [540] 商標 :
Mark:



- [550] 商標種類 : 一般商標
Mark Type:

一系列商標 :	否
Series Mark:	
[571] 商標描述 :	不適用
Mark Description:	
[730] 註冊申請人的姓名 / 名稱、地址 :	深圳減字科技有限公司
Applicant(s) 'Name, Address:	中國
	廣東省深圳市
	南山區粵海街道麻嶺社區深南大道 9968 號漢京金融中心 1405
[740/ 註冊申請人的送達地址 :	滙誠知識產權有限公司
750] Applicant's Address for Service:	香港
	灣仔軒尼詩道 8-12 號
	中港大廈 8 樓
[511] 類別編號 :	11, 14, 20, 21, 35
Class(es) No(s) .:	
[511] 貨品 / 服務說明 :	類別 14:
Specification:	未加工或半加工貴金屬 ; 貴金屬 ; 首飾盒 ; 寶石 ; 珠寶首飾 ; 首飾配件 ; 耳環 ; 首飾用小飾物 ; 貴金屬製鑰匙圈 ; 手錶 ; 錶帶 ; 計時儀器 ; 鐘 ; 鬧鐘
[526] 卸棄 :	不適用
Disclaimer:	
[529] 限制 :	不適用
Limitation:	
[527] 條件 :	不適用
Condition:	
其他 :	不適用
Others	
[220] 提交日期 :	16-09-2021
Date of Filing:	
[320] 聲稱具有優先權的日期 :	不適用
Date of Priority Claimed:	
[310] 優先權申請編號 :	不適用
Priority Application Number:	
[340] 聲稱具有優先權 (部分) :	不適用
Priority Claim Details:	
[330] 優先權申請的	不適用
國家、地區、地方 :	
Country, territory, area of Priority Applications:	
<hr/>	
[210] 商標申請編號 :	305749732
Application No.:	

[540] 商標：
Mark:

A



B

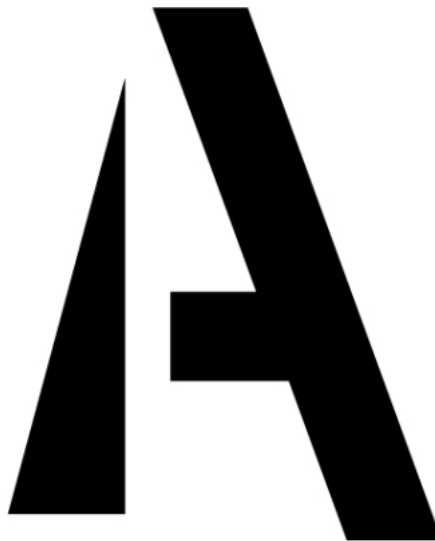

C

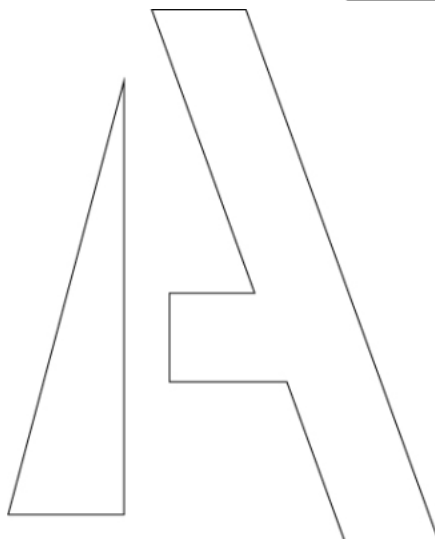

D

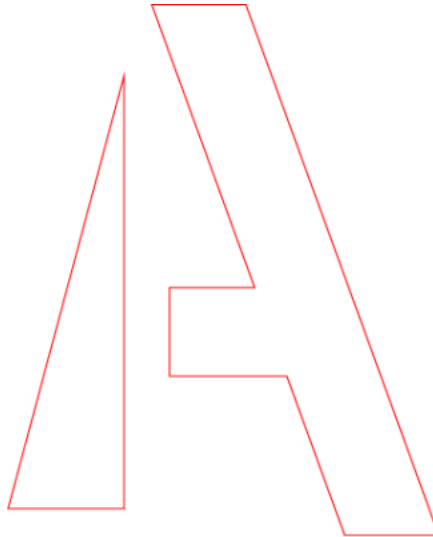

- [550] 商標種類 : Ordinary
 Mark Type:
 一系列商標 : YES
 Series Mark:
- [571] 商標描述 : N/A
 Mark Description:
- [730] 註冊申請人的姓名 / 名稱、地址 : Goldway Technology Limited
 Applicant(s) ' Unit 103, 1/F, Lakeside 2 (Building 10W),
 Name, Address: Phase 2,
 Hong Kong Science Park, Pak Shek Kok, New
 Territories
 HONG KONG
- ASIAN GEMMOLOGICAL INSTITUTE AND LABORATORY
 LIMITED
 707-708, 7/F, Hang Seng Tsimshatsui Building
 18 Carnarvon Road, Tsim Sha Tsui, Kowloon
 HONG KONG
- [740/ 註冊申請人的送達地址 : LETTERS & THOO LIMITED
 750] Applicant's Address for Suite 1008, Prosperity Millennia Plaza,
 Service: 663 King's Road, Quarry Bay
 HONG KONG
- [511] 類別編號 : 14, 42
 Class(es) No(s) .:
- [511] 貨品 / 服務說明 : Class 14:
 Specification: Precious metals and their alloys; jewellery
 and imitation jewellery; precious and semi-
 precious gemstones.
 Class 42:
 Gemological services, namely, the
 classification, grading, identification,
 authentication, inspection, weighing,
 measuring, verifying, cleaning, analysis,
 sorting, evaluation, valuation, inscription,
 identification marking, cut analysis of
 diamonds and other gemstones, colour grading
 of diamonds, clarity grading of diamonds,
 verification and certification of gemstones

including precious gemstones, semi-precious gemstones and diamonds.

- [526] 卸棄: N/A
Disclaimer:
- [529] 限制: N/A
Limitation:
- [527] 條件: N/A
Condition:
其他: N/A
Others
- [220] 提交日期: 17-09-2021
Date of Filing:
- [320] 聲稱具有優先權的日期: N/A
Date of Priority Claimed:
- [310] 優先權申請編號: N/A
Priority Application Number:
- [340] 聲稱具有優先權 (部分): N/A
Priority Claim Details:
- [330] 優先權申請的
國家、地區、地方: N/A
Country, territory, area of
Priority Applications:
-
-

- [210] 商標申請編號: 305749930
Application No.:
- [540] 商標:
Mark:



- [550] 商標種類: Ordinary
Mark Type:
一系列商標: NO
Series Mark:

- [571] 商標描述 : N/A
Mark Description:
- [730] 註冊申請人的姓名 / 名稱、地址 : HRX S.R.L.
Applicant(s) ' VIA VITTORIO AMEDEO II, 6
Name, Address: 10121 TORINO
ITALY
- [740/ 註冊申請人的送達地址 : SIT, FUNG, KWONG & SHUM
750] Applicant's Address for 9th Floor, York House, The Landmark
Service: 15 Queen's Road Central
HONG KONG
- [511] 類別編號 : 14
Class(es) No(s) .:
- [511] 貨品 / 服務說明 : Class 14:
Specification: watches; chronographs [watches]; automobile
clocks; key rings; costume jewellery.
- [526] 卸棄 : N/A
Disclaimer:
- [529] 限制 : N/A
Limitation:
- [527] 條件 : N/A
Condition:
- 其他 : N/A
Others
- [220] 提交日期 : 18-09-2021
Date of Filing:
- [320] 聲稱具有優先權的日期 : N/A
Date of Priority Claimed:
- [310] 優先權申請編號 : N/A
Priority Application Number:
- [340] 聲稱具有優先權 (部分) : N/A
Priority Claim Details:
- [330] 優先權申請的 N/A
國家、地區、地方 :
Country, territory, area of
Priority Applications:
-
-

- [210] 商標申請編號 : 305754178
Application No.:
- [540] 商標 :
Mark:

LOUVE

[550] 商標種類: Ordinary
Mark Type:
一系列商標: NO
Series Mark:

[571] 商標描述: N/A
Mark Description:

[730] 註冊申請人的姓名 / 名稱、地址: MASION MUGUET LIMITED
Applicant(s) ' 1/F, 52 HOLLYWOOD ROAD
Name, Address: CENTRAL
HONG KONG

[740/ 註冊申請人的送達地址: DIAMI INTELLECTUAL PROPERTY COMPANY LIMITED
750] Applicant's Address for Unit 1102, 11/F. 88 Gloucester Road,
Service: Wanchai
HONG KONG

[511] 類別編號: 14
Class(es) No(s) .:

[511] 貨品 / 服務說明: Class 14:
Specification: Precious metals and their alloys and goods in
precious metals or coated therewith, not
included in other classes; jewellery, precious
stones; rings; necklaces; bracelets; lockets;
brooches; earrings; key rings; chains
[jewellery]; crystals and silver ornaments;
jewellery boxes; horological and chronometric
instruments; watches; cases for above-
mentioned goods; all included in Class 14.

[526] 卸棄: N/A
Disclaimer:

[529] 限制: N/A
Limitation:

[527] 條件: N/A
Condition:
其他: N/A
Others

[220] 提交日期: 23-09-2021
Date of Filing:

[320] 聲稱具有優先權的日期: N/A
Date of Priority Claimed:

[310] 優先權申請編號: N/A
Priority Application Number:

[340] 聲稱具有優先權 (部分): N/A
Priority Claim Details:

[330] 優先權申請的 國家、地區、地方: N/A
Country, territory, area of
Priority Applications:

[210] 商標申請編號: 305760360

Application No.:

[540] 商標:

Mark:



- [550] 商標種類: Ordinary
 Mark Type:
 一系列商標: NO
 Series Mark:
- [571] 商標描述: N/A
 Mark Description:
- [730] 註冊申請人的姓名 / 名稱、地址: MANUFACTURE JD
 Applicant(s) ' 7 rue Léo Delibes,
 Name,Address: 75016 PARIS,
 FRANCE
- [740/ 註冊申請人的送達地址: NTD PATENT & TRADE MARK AGENCY LIMITED
 750] Applicant's Address for Units 1805-6, 18/F., Greenfield Tower,
 Service: Concordia Plaza,
 No. 1 Science Museum Road, Tsimshatsui East,
 Kowloon,
 HONG KONG
- [511] 類別編號: 3, 9, 14, 18, 25
 Class(es) No(s) .:
- [511] 貨品 / 服務說明: Class 14:
 Specification: Jewellery; precious stones; paste jewellery;
 necklaces (jewellery); long necklaces
 (jewellery); crew necklace (jewellery);
 bracelets (jewellery); rings (jewellery);
 earrings (jewellery); pendants (jewellery);
 brooches (jewellery); badges (jewellery); cuff
 links (jewellery); medals (jewellery); lockets
 (jewellery); bracelets charms; jewellery
 ornaments for head; jewellery ornaments for
 body; jewellery ornaments for hands; tie
 clips; tie pins; chains (jewellery);
 chronometric apparatus and instruments;
 precious metals and their alloys; works of art
 of precious metal; jewel cases; boxes of
 precious metal; leather jewellery boxes; watch
 cases; watch bands; watch chains; watch
 springs; watch glasses; fancy key rings; key
 fobs of precious metal; key rings (split rings)

with trinket or decorative fob); statues of precious metal; figurines of precious metal; case for clock and watchmaking; cases for watches for presentation purposes; medals.

- [526] 卸棄: N/A
Disclaimer:
- [529] 限制: N/A
Limitation:
- [527] 條件: N/A
Condition:
其他: N/A
Others
- [220] 提交日期: 29-09-2021
Date of Filing:
- [320] 聲稱具有優先權的日期: 30-03-2021
Date of Priority Claimed:
- [310] 優先權申請編號: 21 4 749 676
Priority Application Number:
- [340] 聲稱具有優先權 (部分): N/A
Priority Claim Details:
- [330] 優先權申請的
國家、地區、地方: FRANCE
Country, territory, area of
Priority Applications:

- [210] 商標申請編號: 305760379
Application No.:
- [540] 商標:
Mark:



- [550] 商標種類: Ordinary
Mark Type:
一系列商標: NO
Series Mark:
- [571] 商標描述: N/A
Mark Description:
- [730] 註冊申請人的姓名 / 名稱、地址: MANUFACTURE JD
Applicant(s) ' 7 rue Léo Delibes,
Name,Address:

75016 PARIS,
FRANCE

[740/ 註冊申請人的送達地址 :
750] Applicant's Address for
Service: NTD PATENT & TRADE MARK AGENCY LIMITED
Units 1805-6, 18/F., Greenfield Tower,
Concordia Plaza,
No. 1 Science Museum Road, Tsimshatsui East,
Kowloon,
HONG KONG

[511] 類別編號 : 3,9,14,18,25
Class(es) No(s) .:

[511] 貨品 / 服務說明 :
Specification: Class 14:
Jewellery; precious stones; paste jewellery;
necklaces (jewellery); long necklaces
(jewellery); crew necklace (jewellery);
bracelets (jewellery); rings (jewellery);
earrings (jewellery); pendants (jewellery);
brooches (jewellery); badges (jewellery); cuff
links (jewellery); medals (jewellery); locket
(jewellery); bracelets charms; jewellery
ornaments for head; jewellery ornaments for
body; jewellery ornaments for hands; tie
clips; tie pins; chains (jewellery);
chronometric apparatus and instruments;
precious metals and their alloys; works of art
of precious metal; jewel cases; boxes of
precious metal; leather jewellery boxes; watch
cases; watch bands; watch chains; watch
springs; watch glasses; fancy key rings; key
fobs of precious metal; key rings (split rings
with trinket or decorative fob); statues of
precious metal; figurines of precious metal;
case for clock and watchmaking; cases for
watches for presentation purposes; medals.

[526] 卸棄 :
Disclaimer: N/A

[529] 限制 :
Limitation: N/A

[527] 條件 :
Condition: N/A

其他 :
Others N/A

[220] 提交日期 : 29-09-2021
Date of Filing:

[320] 聲稱具有優先權的日期 : 30-03-2021
Date of Priority Claimed:

[310] 優先權申請編號 : 21 4 749 683
Priority Application Number:

[340] 聲稱具有優先權 (部分) : N/A
Priority Claim Details:

[330] 優先權申請的
國家、地區、地方 : FRANCE
Country, territory, area of
Priority Applications:

[210] 商標申請編號 : 305764014
Application No.:

[540] 商標 :
Mark: **PEONIA DIAMOND**

[550] 商標種類 : Ordinary
Mark Type:
一系列商標 : NO
Series Mark:

[571] 商標描述 : N/A
Mark Description:

[730] 註冊申請人的姓名 / 名稱、地址 : Intelligent Joyful International Limited
Applicant(s) ' Name, Address: Vistra Corporate Services Centre, Wickhams Cay II, Road Town, Tortola, VG1110, BRITISH VIRGIN ISLANDS

[740/ 註冊申請人的送達地址 : Ronald Tong & Co
750] Applicant's Address for Service: Room 501, 5/F., Sun Hung Kai Centre, 30 Harbour Road HONG KONG

[511] 類別編號 : 14,35
Class(es) No(s).:

[511] 貨品 / 服務說明 : Class 14:
Specification: Jewelry; Diamonds; Precious stones; Precious metals, unwrought or semi-wrought; watches.
Class 35:
Advertising, Business management, Business administration, Office functions.

[526] 卸棄 : N/A
Disclaimer:

[529] 限制 : N/A
Limitation:

[527] 條件 : N/A
Condition:
其他 : N/A
Others

[220] 提交日期 : 04-10-2021
Date of Filing:

[320] 聲稱具有優先權的日期 : N/A
Date of Priority Claimed:

[310] 優先權申請編號 : N/A
Priority Application Number:

[340] 聲稱具有優先權 (部分) : N/A
Priority Claim Details:

[330] 優先權申請的 : N/A

國家、地區、地方：

Country, territory, area of

Priority Applications:

-
- [210] 商標申請編號： 305770099
Application No.:
- [540] 商標： A
Mark: 古寶琳
- B
古宝琳
- [550] 商標種類： Ordinary
Mark Type:
一系列商標： YES
Series Mark:
- [571] 商標描述： N/A
Mark Description:
- [730] 註冊申請人的姓名 / 名稱、地址： Gübelin AG
Applicant(s) ' Maihofstrasse 102,
Name, Address: 6006 Lucerne,
SWITZERLAND
- [740/ 註冊申請人的送達地址： DEACONS
750] Applicant's Address for 5th Floor,
Service: Alexandra House Central
HONG KONG
- [511] 類別編號： 14, 41, 42
Class(es) No(s) .:
- [511] 貨品 / 服務說明： Class 14:
Specification: Precious metals and their alloys and goods in
precious metals or coated therewith, not
included in other classes; works of art of
precious metal; jewellery boxes; jewellery,
precious and semi-precious stones; horological
and chronometric instruments.
Class 41:
Education; providing of training;
entertainment; sporting and cultural
activities; arranging and conducting of
seminars and providing of training in the
field of gemology; publication of texts
(except advertising texts); electronic

publishing services; all included in Class 41.
Class 42:

Scientific and technological services and research and design relating thereto; industrial analysis and research services; design and development of computer hardware and software; gemological expertise, identification, classifying and authentication of diamonds, gem stones and pearls (expert appraisal services); determination of the origin of colored gem stones, analysis of precious metal; quality control; technical research; applied technical research on extracting of and exploring of gem stones; design of jewellery; all included in Class 42.

[526]	卸棄： Disclaimer:	N/A
[529]	限制： Limitation:	N/A
[527]	條件： Condition:	N/A
	其他： Others	N/A
[220]	提交日期： Date of Filing:	12-10-2021
[320]	聲稱具有優先權的日期： Date of Priority Claimed:	N/A
[310]	優先權申請編號： Priority Application Number:	N/A
[340]	聲稱具有優先權 (部分)： Priority Claim Details:	N/A
[330]	優先權申請的 國家、地區、地方： Country, territory, area of Priority Applications:	N/A
