

香港知識產權公報

Hong Kong Intellectual Property Journal

2021年4月30日

30 April 2021



目錄 Contents

根據註冊外觀設計條例第 25 條註冊的外觀設計

Designs Registered under section 25 of the Registered Designs Ordinance

按註冊編號排列

Arranged by Registration Number

根據註冊外觀設計條例(第 522 章)公布的其他公告

Other Notices Published under the Registered Designs Ordinance (Cap. 522)

根據註冊外觀設計條例第 28 條，註冊外觀設計因未繳續期費而停止有效

Registered designs ceased through non-payment of renewal fees under section 28 of the Registered Designs Ordinance

根據註冊外觀設計規則第 31 條刪除的註冊外觀設計

Registered designs removed under section 31 of the Registered Designs Rules

根據註冊外觀設計條例第 76 條，更正已提交文件中的錯誤

Correction of errors in filed documents under section 76 of the Registered Designs Ordinance

以下事項沒有記錄

No Records for the Following Matters

根據註冊外觀設計條例第 30 條放棄的外觀設計的註冊

Surrender of Registration of Design under section 30 of the Registered Designs Ordinance

根據註冊外觀設計規則第 37 條，向處長作出轉介

Reference to Registrar under section 37 of the Registered Designs Rules

根據註冊外觀設計條例第 45 條，撤銷註冊

Revocation of Registration under section 45 of the Registered Designs Ordinance

根據註冊外觀設計規則第 46 條，向法院作出轉介

Reference to Court under section 46 of the Registered Designs Rules

根據註冊外觀設計規則第 63 條對不符合規定之處作出糾正

Rectification of Irregularities under section 63 of the Registered Designs Rules

根據註冊外觀設計條例第 66 條，糾正註冊紀錄冊

Rectification of Register under section 66 of the Registered Designs Ordinance

根據註冊外觀設計條例第 67 條 更正註冊紀錄冊內的錯誤

Correction of errors in Register under section 67 of the Registered Designs Ordinance

根據註冊外觀設計條例第 67 及 76 條，更正註冊紀錄冊內及已提交文件中的錯誤

Correction of Errors in Register and in Filed Documents under sections 67 and 76 of the Registered Designs Ordinance

勘誤

Corrigendum

註冊外觀設計公告註釋

Notes on advertisements of registration of designs

方括號表示下列資料：

Square brackets indicate the following data：

[11] 註冊編號 Registration number / 聯合王國註冊編號 United Kingdom registration number

[15] 註冊日期 Registration date / 當作註冊日期 Deemed registration date / 聯合王國註冊日期 United Kingdom registration date

[17] 註冊有效期屆滿日期 Expiry date of the period of registration

[22] 提交日期 Filing date / 當作提交日期 Deemed filing date / 聯合王國提交日期 United Kingdom filing date

[30] 聲稱享有的優先權（提交日期 / 巴黎公約國或世界貿易組織成員 / 申請編號） Priority claimed (filing date / Paris Convention country or WTO member / application number)

[51] 國際外觀設計分類號（洛迦諾分類號） International Classification of designs (Locarno Classification)

[54] 物品 Article

[55] 外觀設計的表述 Representation of the design

[62] 分開前的申請編號及提交日期 Application number before division and filing date

[66] 過往註冊的聯繫外觀設計註冊編號 / 日期 Registration No. / Date of Previous Registration for Association

[72] 設計人 Designer

[73] 擁有人姓名和地址 Name and address of the owner

[74] 代理人 Agent / 送達地址 Address for service



香港特別行政區政府知識產權署外觀設計註冊處

The Government of the Hong Kong Special Administrative Region

Designs Registry, Intellectual Property Department

根據註冊外觀設計條例第 25 條註冊的外觀設計

Designs registered under section 25 of the Registered Designs Ordinance

按註冊編號排列

Arranged by Registration Number

[11] 2016896.1M001

[15] 29-09-2020

[30] 30-03-2020 / EU / 007780267

[51] Cl. 2-01

[54] 衛生內褲

Napkin pants

[73] Essity Hygiene and Health Aktiebolag

Mölnåds bro 2,

405 03 Göteborg,

Sweden

[74] DEACONS

5th Floor, Alexandra House,

Central,

Hong Kong

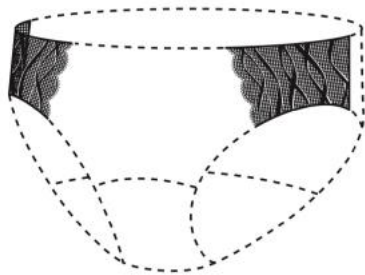

[11] 2016896.1M002

[15] 29-09-2020

[30] 30-03-2020 / EU / 007780267

[51] Cl. 2-01

[54] 衛生內褲

Napkin pants

[73] Essity Hygiene and Health Aktiebolag
Mölnbalds bro 2,
405 03 Göteborg,
Sweden

[74] DEACONS
5th Floor, Alexandra House,
Central,
Hong Kong

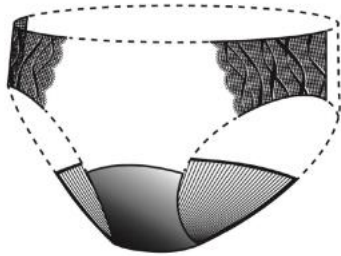

[11] 2017198.1

[15] 09-12-2020

[51] Cl. 11-01

[54] 爪上鑲嵌鑽石戒指
Prong setting diamond ring

[73] 王亞萍
中國內地
上海市松江區泗寶路 298 弄
金地自在城 1 號樓 1602 室

[74] 香港知識產權代理有限公司
香港新界
白石角香港科學園第三期
科技大道西 12 號 2 樓 230 室



- [11] 2017339.1M001
[15] 28-12-2020
[30] 21-10-2020 / CA, LI, MC, NO, RU, SG, CH, TR, GB, US, EU, IL,
JP, KR / WIPO98754
[51] Cl. 28-03
[54] 電動牙刷
Electric toothbrush
[73] VWARDIS AG
Sihlbruggstrasse 109,
6340 Baar,
Switzerland
[74] Vivien Chan & Co.
32nd Floor, Harbour Centre,
25 Harbour Road, Wan Chai,
Hong Kong

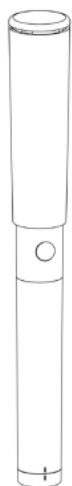

-
- [11] 2017339.1M002
[15] 28-12-2020
[30] 21-10-2020 / CA, LI, MC, NO, RU, SG, CH, TR, GB, US, EU, IL,
JP, KR / WIPO98754
[51] Cl. 28-03
[54] 電動牙刷
Electric toothbrush
[73] VWARDIS AG
Sihlbruggstrasse 109,
6340 Baar,
Switzerland
[74] Vivien Chan & Co.
32nd Floor, Harbour Centre,

25 Harbour Road, Wan Chai,
Hong Kong



[11] 2017339.1M003

[15] 28-12-2020

[30] 21-10-2020 / CA, LI, MC, NO, RU, SG, CH, TR, GB, US, EU, IL,
JP, KR / WIPO98754

[51] Cl. 28-03

[54] 電動牙刷手柄

Electric toothbrush handle

[73] VVARDIS AG

Sihlbruggstrasse 109,

6340 Baar,

Switzerland

[74] Vivien Chan & Co.

32nd Floor, Harbour Centre,

25 Harbour Road, Wan Chai,

Hong Kong



[11] 2017340.3M001

[15] 28-12-2020

[30] 20-10-2020 / CA, LI, MC, NO, RU, SG, CH, TR, GB, US, EU, IL, JP, KR / WIPO98746

[51] Cl. 4-02

[54] 牙刷
Toothbrush

[73] VVARDIS AG
Sihlbruggstrasse 109,
6340 Baar,
Switzerland

[74] Vivien Chan & Co.
32nd Floor, Harbour Centre,
25 Harbour Road, Wan Chai,
Hong Kong



[11] 2017340.3M002

[15] 28-12-2020

[30] 20-10-2020 / CA, LI, MC, NO, RU, SG, CH, TR, GB, US, EU, IL,
JP, KR / WIPO98746

[51] Cl. 4-02

[54] 帶頭牙刷

Toothbrush with head

[73] VWARDIS AG

Sihlbruggstrasse 109,

6340 Baar,

Switzerland

[74] Vivien Chan & Co.

32nd Floor, Harbour Centre,

25 Harbour Road, Wan Chai,

Hong Kong



[11] 2017341.5

[15] 28-12-2020

[30] 20-10-2020 / CA, LI, MC, NO, RU, SG, CH, TR, GB, US, EU, IL,
JP, KR / WIPO98748

[51] Cl. 4-02

[54] 牙刷頭

Toothbrush head

[73] VWARDIS AG

Sihlbruggstrasse 109,

6340 Baar,

Switzerland

[74] Vivien Chan & Co.

32nd Floor, Harbour Centre,

25 Harbour Road, Wan Chai,
Hong Kong

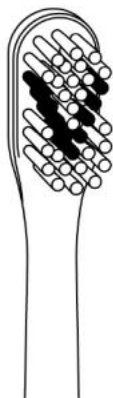

[11] 2117472.3M001

[15] 25-01-2021

[51] Cl. 9-01

Cl. 9-03

[54] 包裝用容器

Packaging container

[73] STARGE KABUSHIKIKAISHA (STARGE. Inc.)

4-32, Aomi 2-chome,

Koto-ku, Tokyo,

Japan

[74] DEACONS

5th Floor, Alexandra House,

Central,

Hong Kong



[11] 2117472.3M002

[15] 25-01-2021

- [51] Cl. 9-01
Cl. 9-03
- [54] 包裝用容器
Packaging container
- [73] STARGE KABUSHIKIKAISHA (STARGE. Inc.)
4-32, Aomi 2-chome,
Koto-ku, Tokyo,
Japan
- [74] DEACONS
5th Floor, Alexandra House,
Central,
Hong Kong



-
- [11] 2117549.8M001
- [15] 05-02-2021
- [30] 06-08-2020 / AU / 202014296
- [51] Cl. 23-01
- [54] 水龍頭頂部
Tap head
- [73] Zip Heaters (Australia) Pty Limited
67 Allingham Street,
Condell Park NSW 2200,
Australia
- [74] SPRUSON & FERGUSON (HONG KONG) LIMITED
5001 Hopewell Centre,
183 Queen's Road East,
Wan Chai, Hong Kong

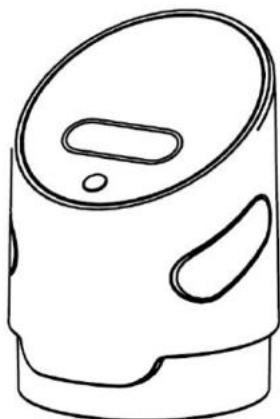

[11] 2117549.8M002

[15] 05-02-2021

[30] 06-08-2020 / AU / 202014297

[51] Cl. 23-01

[54] 水龍頭頂部

Tap head

[73] Zip Heaters (Australia) Pty Limited

67 Allingham Street,
Condell Park NSW 2200,
Australia

[74] SPRUSON & FERGUSON (HONG KONG) LIMITED

5001 Hopewell Centre,
183 Queen's Road East,
Wan Chai, Hong Kong

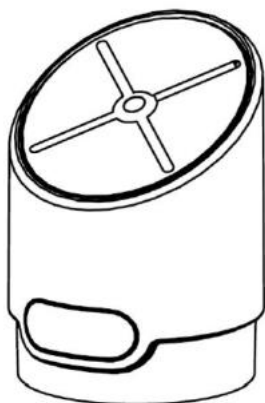

[11] 2117549.8M003

[15] 05-02-2021

[30] 06-08-2020 / AU / 202014298

[51] Cl. 23-01

[54] 水龍頭

Tap

[73] Zip Heaters (Australia) Pty Limited

67 Allingham Street,
Condell Park NSW 2200,
Australia

[74] SPRUSON & FERGUSON (HONG KONG) LIMITED

5001 Hopewell Centre,
183 Queen's Road East,
Wan Chai, Hong Kong



[11] 2117549.8M004

[15] 05-02-2021

[30] 06-08-2020 / AU / 202014299

[51] Cl. 23-01

[54] 水龍頭

Tap

[73] Zip Heaters (Australia) Pty Limited

67 Allingham Street,
Condell Park NSW 2200,
Australia

[74] SPRUSON & FERGUSON (HONG KONG) LIMITED

5001 Hopewell Centre,
183 Queen's Road East,
Wan Chai, Hong Kong

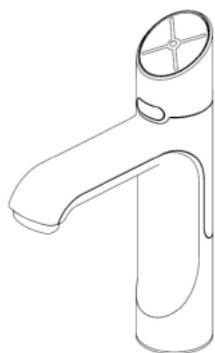

[11] 2117549.8M005

[15] 05-02-2021

[30] 06-08-2020 / AU / 202014300

[51] Cl. 23-01

[54] 水龍頭底座
Tap base

[73] Zip Heaters (Australia) Pty Limited
67 Allingham Street,
Condell Park NSW 2200,
Australia

[74] SPRUSON & FERGUSON (HONG KONG) LIMITED
5001 Hopewell Centre,
183 Queen's Road East,
Wan Chai, Hong Kong

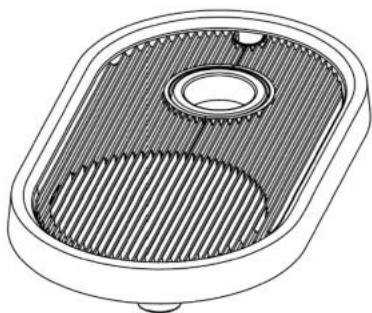

[11] 2117555.1

[15] 08-02-2021

[30] 18-08-2020 / CN / 202030472791.4

[51] Cl. 24-02

[54] 瓣膜修復裝置

Valve repair device

[73] 上海紐脈醫療科技有限公司

SHANG HAI NEWMED MEDICAL CO., LTD.

Room 301, No. 23, Lane 908, Ziping Road,

Zhoupu Town, Pudong New District,

Shanghai 201321, China

[74] CHINA PATENT AGENT (HONG KONG) LIMITED

22/F, Great Eagle Centre,

23 Harbour Road,

Wanchai, Hong Kong

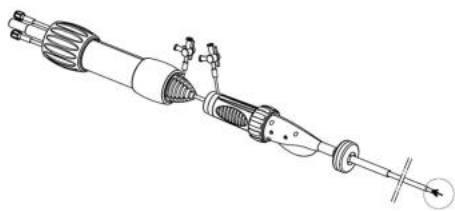

[11] 2117559.9M001

[15] 09-02-2021

[30] 13-08-2020 / US / 29/746,459

[51] Cl. 14-01

[54] 音箱

Speaker

[73] 蘋果公司

APPLE INC.

One Apple Park Way, Cupertino,

California 95014,

United States

[74] CLT PATENT & TRADEMARK (H.K.) LIMITED

Unit 09, 34/F., Office Tower, Convention Plaza,

No. 1 Harbour Road,

Wanchai, Hong Kong

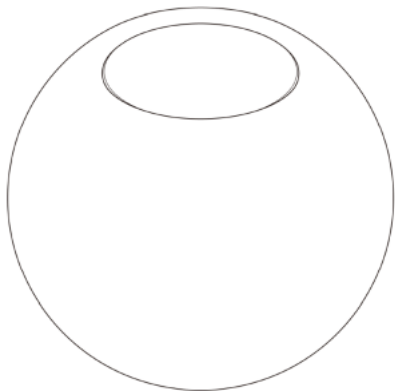

[11] 2117559.9M002

[15] 09-02-2021

[30] 13-08-2020 / US / 29/746,459

[51] Cl. 14-01

[54] 音箱
Speaker

[73] 蘋果公司
APPLE INC.
One Apple Park Way, Cupertino,
California 95014,
United States

[74] CLT PATENT & TRADEMARK (H.K.) LIMITED
Unit 09, 34/F., Office Tower, Convention Plaza,
No. 1 Harbour Road,
Wanchai, Hong Kong



[11] 2117559.9M003

[15] 09-02-2021

[30] 13-08-2020 / US / 29/746,459

[51] Cl. 14-01

[54] 音箱
Speaker

[73] 蘋果公司
APPLE INC.
One Apple Park Way, Cupertino,
California 95014,
United States

[74] CLT PATENT & TRADEMARK (H.K.) LIMITED
Unit 09, 34/F., Office Tower, Convention Plaza,
No. 1 Harbour Road,
Wanchai, Hong Kong



[11] 2117559.9M004

[15] 09-02-2021

[30] 13-08-2020 / US / 29/746,459

[51] Cl. 14-01

[54] 音箱
Speaker

[73] 蘋果公司
APPLE INC.
One Apple Park Way, Cupertino,
California 95014,
United States

[74] CLT PATENT & TRADEMARK (H.K.) LIMITED
Unit 09, 34/F., Office Tower, Convention Plaza,
No. 1 Harbour Road,
Wanchai, Hong Kong



[11] 2117568.8M001

[15] 10-02-2021

[30] 14-08-2020 / US / 29/746,613

[51] Cl. 10-07

[54] 用於智能手錶的錶帶

Band for smart watch

[73] 蘋果公司

APPLE INC.

One Apple Park Way, Cupertino,

California 95014,

United States

[74] CLT PATENT & TRADEMARK (H.K.) LIMITED

Unit 09, 34/F., Office Tower, Convention Plaza,

No. 1 Harbour Road,

Wanchai, Hong Kong

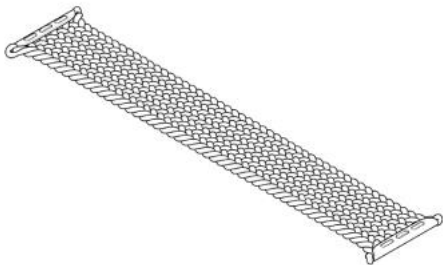

- [11] 2117568.8M002
- [15] 10-02-2021
- [30] 14-08-2020 / US / 29/746,613
- [51] Cl. 10-07
- [54] 用於智能手錶的錶帶
Band for smart watch
- [73] 蘋果公司
APPLE INC.
One Apple Park Way, Cupertino,
California 95014,
United States
- [74] CLT PATENT & TRADEMARK (H.K.) LIMITED
Unit 09, 34/F., Office Tower, Convention Plaza,
No. 1 Harbour Road,
Wanchai, Hong Kong

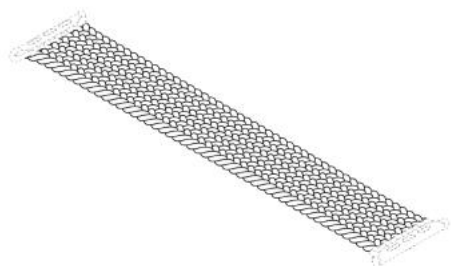

-
- [11] 2117568.8M003
- [15] 10-02-2021
- [30] 14-08-2020 / US / 29/746,613
- [51] Cl. 10-07
- [54] 用於智能手錶的錶帶
Band for smart watch
- [73] 蘋果公司
APPLE INC.
One Apple Park Way, Cupertino,
California 95014,
United States
- [74] CLT PATENT & TRADEMARK (H.K.) LIMITED
Unit 09, 34/F., Office Tower, Convention Plaza,
No. 1 Harbour Road,
Wanchai, Hong Kong

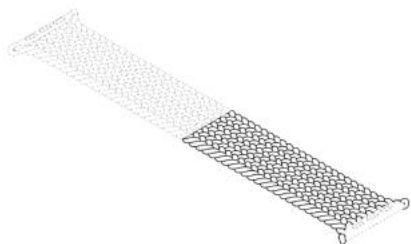

[11] 2117570.2M001

[15] 10-02-2021

[30] 14-08-2020 / US / 29/746,615

[51] Cl. 10-07

[54] 用於智能手錶的錶帶

Band for smart watch

[73] 蘋果公司

APPLE INC.

One Apple Park Way, Cupertino,

California 95014,

United States

[74] CLT PATENT & TRADEMARK (H.K.) LIMITED

Unit 09, 34/F., Office Tower, Convention Plaza,

No. 1 Harbour Road,

Wanchai, Hong Kong

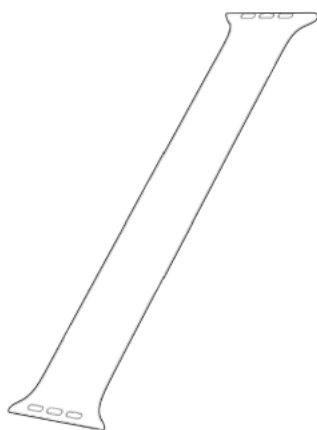

[11] 2117570.2M002

[15] 10-02-2021

[30] 14-08-2020 / US / 29/746,615

[51] Cl. 10-07

[54] 用於智能手錶的錶帶

Band for smart watch

[73] 蘋果公司

APPLE INC.

One Apple Park Way, Cupertino,

California 95014,

United States

[74] CLT PATENT & TRADEMARK (H.K.) LIMITED

Unit 09, 34/F., Office Tower, Convention Plaza,

No. 1 Harbour Road,

Wanchai, Hong Kong

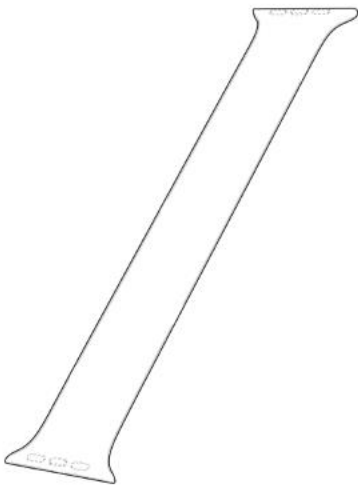

[11] 2117613.4M001

[15] 20-02-2021

[30] 20-08-2020 / US / 29/747,244

[51] Cl. 10-02

[54] 智能手錶

Smartwatch

[73] 蘋果公司

APPLE INC.

One Apple Park Way, Cupertino,

California 95014,

United States

[74] CLT PATENT & TRADEMARK (H.K.) LIMITED

Unit 09, 34/F., Office Tower, Convention Plaza,

No. 1 Harbour Road,

Wanchai, Hong Kong

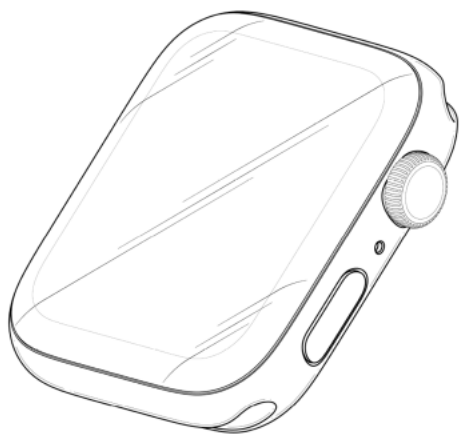

[11] 2117613.4M002

[15] 20-02-2021

[30] 20-08-2020 / US / 29/747,244

[51] Cl. 10-02

[54] 智能手錶

Smartwatch

[73] 蘋果公司

APPLE INC.

One Apple Park Way, Cupertino,

California 95014,

United States

[74] CLT PATENT & TRADEMARK (H.K.) LIMITED

Unit 09, 34/F., Office Tower, Convention Plaza,

No. 1 Harbour Road,

Wanchai, Hong Kong



[11] 2117631.2M001

[15] 26-02-2021

[30] 28-08-2020 / US / 29/748,439

[51] Cl. 14-03

Cl. 14-02

Cl. 14-01

[54] 電子裝置

Electronic device

[73] 蘋果公司

APPLE INC.

One Apple Park Way, Cupertino,

California 95014,

United States

[74] CLT PATENT & TRADEMARK (H.K.) LIMITED

Unit 09, 34/F., Office Tower, Convention Plaza,

No. 1 Harbour Road,

Wanchai, Hong Kong

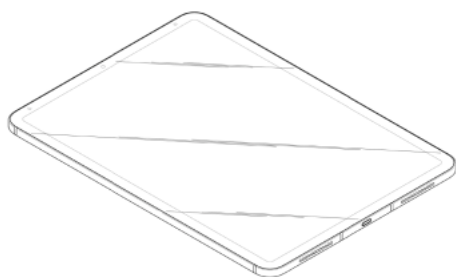

[11] 2117631.2M002

[15] 26-02-2021

[30] 28-08-2020 / US / 29/748,439

[51] Cl. 14-03

Cl. 14-02

Cl. 14-01

[54] 電子裝置

Electronic device

[73] 蘋果公司

APPLE INC.

One Apple Park Way, Cupertino,

California 95014,

United States

[74] CLT PATENT & TRADEMARK (H.K.) LIMITED

Unit 09, 34/F., Office Tower, Convention Plaza,

No. 1 Harbour Road,
Wanchai, Hong Kong



-
- [11] 2117634.8
[15] 26-02-2021
[30] 31-08-2020 / JP / 018389 of 2020
[51] Cl. 7-02
[54] 咖啡濾杯
Coffee dripper
[73] 株式會社瑪娜
MARNA INC.
3-15, Higashikomagata 1-chome,
Sumida-ku, Tokyo 130-0005,
Japan
[74] SANYOU INTELLECTUAL PROPERTY LIMITED
Room 601, 6/F., Yue Xiu Building,
160-174 Lockhart Road,
Wan Chai, Hong Kong



- [11] 2117723.7
[15] 19-03-2021
[51] Cl. 31-00
[54] 水機
Water dispenser
[73] A.S. Watson TM Limited
Vistra Corporate Services Centre,
Wickhams Cay II, Road Town, Tortola, VG1110,
Virgin Islands, British
[74] Hutchison Whampoa Agents Limited
48th Floor, Cheung Kong Center,
2 Queen's Road Central,
Hong Kong



-
- [11] 2117737.7
[15] 23-03-2021
[51] Cl. 23-04
[54] 香薰機
Aroma diffuser
[73] 璞真生活有限公司
PUZHEN LIFE CO., LTD
Unit 1112-1116, 11/F, Delta House,
3 On Yiu Street,
Shatin, Hong Kong
[74] FEDERATION OF HONG KONG INDUSTRIES
31/F, Billion Plaza,
8 Cheung Yue Street,
Cheung Sha Wan, Kowloon, Hong Kong



[11] 2117738.9

[15] 23-03-2021

[51] Cl. 23-04

[54] 香薰機

Aroma diffuser

[73] 璞真生活有限公司

PUZHEN LIFE CO., LTD

Unit 1112-1116, 11/F, Delta House,

3 On Yiu Street,

Shatin, Hong Kong

[74] FEDERATION OF HONG KONG INDUSTRIES

31/F, Billion Plaza,

8 Cheung Yue Street,

Cheung Sha Wan, Kowloon, Hong Kong

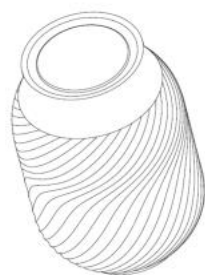

[11] 2117739.1

[15] 23-03-2021

[30] 23-09-2020 / EU / 008178552-0001

[51] Cl. 23-01

[54] 流體分配機

Fluid dispenser

[73] Carlsberg Breweries A/S
J.C. Jacobsens Gade 1,
1799 Copenhagen V,
Denmark

[74] SPRUSON & FERGUSON (HONG KONG) LIMITED
5001 Hopewell Centre,
183 Queen's Road East,
Wan Chai, Hong Kong



[11] 2117744.1

[15] 23-03-2021

[51] Cl. 9-01

[54] 化妝品容器
Cosmetic container

[73] 凱諾帝私人有限公司
Klarity SG Pte Ltd
33 Ubi Avenue 3,
#05-52 Vertex Singapore 408868,
Singapore

[74] ACCOLADE IP LIMITED
10/F, Fu Fai Comm. Ctr.,
27 Hillier Street,
Sheung Wan, Hong Kong



[11] 2117745.4

[15] 23-03-2021

[51] Cl. 21-01

[54] 模型車

Model vehicle

[73] KABUSHIKI KAISHA TAMIYA (TAMIYA, INC.)

3-7, Ondawara,
Shizuoka-City, 422-8610,
Japan

[74] CHAN, TANG & KWOK

Rooms 2503-04, 25/F.,
Shanghai Industrial Investment Building,
48-62 Hennessy Road,
Wanchai, Hong Kong

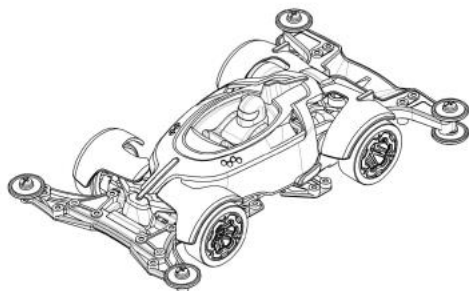

[11] 2117746.6

[15] 23-03-2021

[30] 25-09-2020 / FR / 2020-4323

[51] Cl. 3-01

[54] 袋

Bag

[73] VALENTINO S.p.A.

Via Turati, 16/18,
I-20121 Milano,
Italy

[74] BARRON & YOUNG INTELLECTUAL PROPERTY LIMITED

Suite 617, Lakeside 2,
No. 10 Science Park West Avenue,
Hong Kong Science Park, Shatin, N.T., Hong Kong



[11] 2117747.8M001

[15] 23-03-2021

[30] 25-09-2020 / FR / 2020-4321

[51] Cl. 2-04

[54] 鞋

Shoe

[73] VALENTINO S.p.A.

Via Turati, 16/18,

I-20121 Milano,

Italy

[74] BARRON & YOUNG INTELLECTUAL PROPERTY LIMITED

Suite 617, Lakeside 2,

No. 10 Science Park West Avenue,

Hong Kong Science Park, Shatin, N.T., Hong Kong

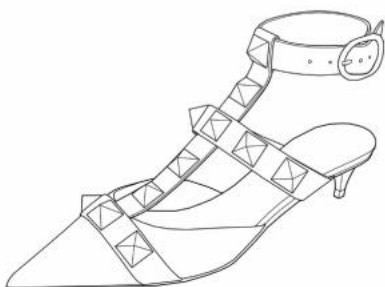

[11] 2117747.8M002

[15] 23-03-2021

[30] 25-09-2020 / FR / 2020-4321

[51] Cl. 2-04

[54] 鞋
Shoe

[73] VALENTINO S.p.A.
Via Turati, 16/18,
I-20121 Milano,
Italy

[74] BARRON & YOUNG INTELLECTUAL PROPERTY LIMITED
Suite 617, Lakeside 2,
No. 10 Science Park West Avenue,
Hong Kong Science Park, Shatin, N.T., Hong Kong



[11] 2117747.8M003

[15] 23-03-2021

[30] 25-09-2020 / FR / 2020-4321

[51] Cl. 2-04

[54] 鞋
Shoe

[73] VALENTINO S.p.A.
Via Turati, 16/18,
I-20121 Milano,
Italy

[74] BARRON & YOUNG INTELLECTUAL PROPERTY LIMITED
Suite 617, Lakeside 2,
No. 10 Science Park West Avenue,
Hong Kong Science Park, Shatin, N.T., Hong Kong



[11] 2117747.8M004

[15] 23-03-2021

[30] 25-09-2020 / FR / 2020-4321

[51] Cl. 2-04

[54] 鞋

Shoe

[73] VALENTINO S.p.A.

Via Turati, 16/18,

I-20121 Milano,

Italy

[74] BARRON & YOUNG INTELLECTUAL PROPERTY LIMITED

Suite 617, Lakeside 2,

No. 10 Science Park West Avenue,

Hong Kong Science Park, Shatin, N.T., Hong Kong

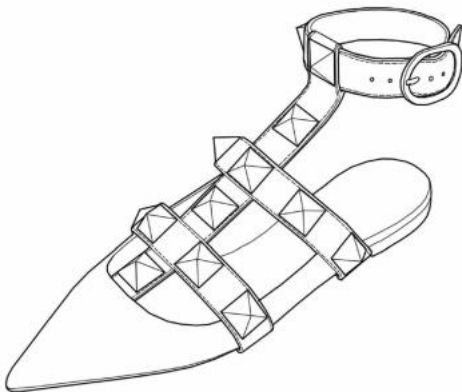

[11] 2117747.8M005

[15] 23-03-2021

[30] 25-09-2020 / FR / 2020-4321

[51] Cl. 2-04

[54] 鞋

Shoe

[73] VALENTINO S.p.A.

Via Turati, 16/18,

I-20121 Milano,

Italy

[74] BARRON & YOUNG INTELLECTUAL PROPERTY LIMITED

Suite 617, Lakeside 2,

No. 10 Science Park West Avenue,

Hong Kong Science Park, Shatin, N.T., Hong Kong

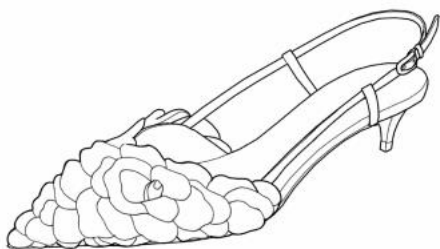

[11] 2117747.8M006

[15] 23-03-2021

[30] 25-09-2020 / FR / 2020-4321

[51] Cl. 2-04

[54] 鞋

Shoe

[73] VALENTINO S.p.A.

Via Turati, 16/18,

I-20121 Milano,

Italy

[74] BARRON & YOUNG INTELLECTUAL PROPERTY LIMITED

Suite 617, Lakeside 2,

No. 10 Science Park West Avenue,

Hong Kong Science Park, Shatin, N.T., Hong Kong



[11] 2117748.0

[15] 24-03-2021

[51] Cl. 29-02

[54] 防菌口罩

Antibacterial mask

[73] NCK Limited

Flat/Rm E, Blk 2, 28/F, Vigor Ind Bldg,
49-53 Ta Chuen Ping Street,
Kwai Chung, New Territories, Hong Kong

[74] PROREG INTELLECTUAL PROPERTY CONSULTING LIMITED

26/F,
88 Lockhart Road,
Wan Chai, Hong Kong



[11] 2117750.4

[15] 24-03-2021

[51] Cl. 24-99

[54] 大腳趾矯正器

Correcting apparatus for big toe

[73] Y.H. Life Co., Ltd.

#B107, John Choi Hall, Catholic University of Daegu,
Hayang-ro, Hayang-eup, Gyeongsan-si,
Gyeongsangbuk-do,
Korea, Republic of

[74] KIM & COMPANY, SOLICITORS

9/F., Fontaine Building,
18 Mody Road,
Tsim Sha Tsui, Kowloon, Hong Kong

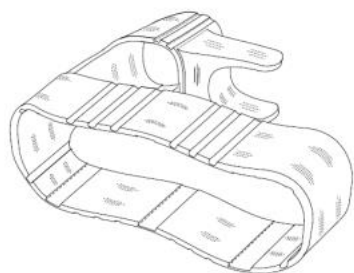

[11] 2117753.0M001

[15] 24-03-2021

[51] Cl. 9-03

[54] 包裝用容器
Packaging container

[73] 株式會社松本清控股公司
KABUSHIKI KAISHA MATSUMOTOKIYOSHI HOLDINGS (ALSO TRADING AS
MATSUMOTOKIYOSHI HOLDINGS CO., LTD.)
9-1, Shinmatsudo-Higashi,
Matsudo-Shi, Chiba-Ken,
Japan

[74] FAIRBAIRN CATLEY LOW & KONG
23/F, Shui On Centre,
6-8 Harbour Road,
Wanchai, Hong Kong



[11] 2117753.0M002

[15] 24-03-2021

[51] Cl. 9-03

[54] 包裝用容器
Packaging container

- [73] 株式會社松本清控股公司
KABUSHIKI KAISHA MATSUMOTOKIYOSHI HOLDINGS (ALSO TRADING AS
MATSUMOTOKIYOSHI HOLDINGS CO., LTD.)
9-1, Shinmatsudo-Higashi,
Matsudo-Shi, Chiba-Ken,
Japan
- [74] FAIRBAIRN CATLEY LOW & KONG
23/F, Shui On Centre,
6-8 Harbour Road,
Wanchai, Hong Kong



-
- [11] 2117755.5
- [15] 29-03-2021
- [51] Cl. 11-04
- [54] 天鵝形花藝擺設
Floral art of swan
- [73] 葉兆寧
Yip Siu Ning
香港新界
天水圍天富苑
朗富閣 35 樓 07 室
- [74] 葉兆寧
香港新界
天水圍天富苑
朗富閣 35 樓 07 室



[11] 2117756.7M001

[15] 25-03-2021

[30] 22-10-2020 / CA, AM, AZ, BZ, BA, GE, LI, MK, MD, MC, MN, ME,
MA, NO, OM, SG, CH, TN, TR, UA, GB, EU, AL, KG / DM/210 959

[51] Cl. 11-01

[54] 指環

Ring

[73] Harry Winston SA

Chemin du Tourbillon 8,
CH-1228 Plan-les-Ouates,
Switzerland

[74] SPRUSON & FERGUSON (HONG KONG) LIMITED

5001 Hopewell Centre,
183 Queen's Road East,
Wan Chai, Hong Kong



[11] 2117756.7M002

- [15] 25-03-2021
- [30] 22-10-2020 / CA, AM, AZ, BZ, BA, GE, LI, MK, MD, MC, MN, ME, MA, NO, OM, SG, CH, TN, TR, UA, GB, EU, AL, KG / DM/210 959
- [51] Cl. 11-01
- [54] 手鏈
Bracelet
- [73] Harry Winston SA
Chemin du Tourbillon 8,
CH-1228 Plan-les-Ouates,
Switzerland
- [74] SPRUSON & FERGUSON (HONG KONG) LIMITED
5001 Hopewell Centre,
183 Queen's Road East,
Wan Chai, Hong Kong



-
- [11] 2117756.7M003
- [15] 25-03-2021
- [30] 22-10-2020 / CA, AM, AZ, BZ, BA, GE, LI, MK, MD, MC, MN, ME, MA, NO, OM, SG, CH, TN, TR, UA, GB, EU, AL, KG / DM/210 959
- [51] Cl. 11-01
- [54] 指環
Ring
- [73] Harry Winston SA
Chemin du Tourbillon 8,
CH-1228 Plan-les-Ouates,
Switzerland
- [74] SPRUSON & FERGUSON (HONG KONG) LIMITED
5001 Hopewell Centre,
183 Queen's Road East,
Wan Chai, Hong Kong



[11] 2117758.1M001

[15] 25-03-2021

[30] 30-09-2020 / CH, GB, EU / DM/210 864

[51] Cl. 10-02

[54] 錶

Watch

[73] Montblanc-Simplo GmbH

Hellgrundweg 100,

22525 Hamburg,

Germany

[74] UNION PATENT SERVICE CENTRE

Units E-F, 20th Floor, Neich Tower,

128 Gloucester Road,

Hong Kong



[11] 2117758.1M002

[15] 25-03-2021

[30] 30-09-2020 / CH, GB, EU / DM/210 864

[51] Cl. 10-07

[54] 錶面

Watch dial

[73] Montblanc-Simplo GmbH

Hellgrundweg 100,
22525 Hamburg,
Germany

[74] UNION PATENT SERVICE CENTRE

Units E-F, 20th Floor, Neich Tower,
128 Gloucester Road,
Hong Kong



[11] 2117758.1M003

[15] 25-03-2021

[30] 30-09-2020 / CH, GB, EU / DM/210 864

[51] Cl. 10-02

[54] 錶

Watch

[73] Montblanc-Simplo GmbH

Hellgrundweg 100,
22525 Hamburg,
Germany

[74] UNION PATENT SERVICE CENTRE

Units E-F, 20th Floor, Neich Tower,
128 Gloucester Road,
Hong Kong



[11] 2117759.3

[15] 25-03-2021

[51] Cl. 14-06

[54] 手機支架

Mobile phone holder

[73] 杰美泰實業（深圳）有限公司

中國內地

廣東省深圳市寶安區沙井街道

茅洲山工業園工業大廈

全至科技創新園科創大廈 14 層 G

[74] 海思國際知識產權有限公司

香港灣仔

皇后大道東 183 號

合和中心 54 樓

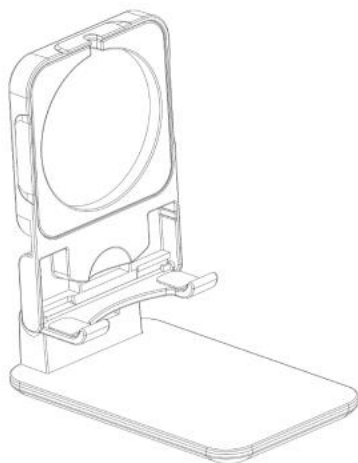



香港特別行政區政府知識產權署外觀設計註冊處

The Government of the Hong Kong Special Administrative Region

Designs Registry, Intellectual Property Department

根據註冊外觀設計條例第 28 條，下列註冊外觀設計因未繳續期費而停止有效。

各組記項按註冊外觀設計停止有效日期及註冊編號先後次序排列。

Registered designs ceased through non-payment of renewal fees under section 28 of the Registered Designs Ordinance. Entries are listed below under their expiry dates.

04-02-2021 - 10-02-2021**04-02-2021**

1600207.7
1600213.9
1600217.8M003
1600217.8M008
1600217.8M009
1600218.0M001
1600218.0M002
1600218.0M003
1600220.4
1600223.0
1600224.2M001
1600224.2M002

05-02-2021

0600341.8M001
0600341.8M002
0600341.8M003
0600341.8M004
0600341.8M005
0600341.8M006

06-02-2021

0600345.7
1100194.2
1600226.7
1600227.9
1600228.1
1600229.3
1600230.5
1600231.7
1600232.9
1600233.1
1600234.3

07-02-2021

0110184.1M001
0110184.1M002
0110184.1M003
0110184.1M004
0110184.1M005
0110184.1M006
0110184.1M007
0600356.0M001
0600356.0M003

08-02-2021

0600363.4M001
0600363.4M002
0600365.9
1100198.1
1100199.3M001
1100199.3M002
1100199.3M003
1100200.7

09-02-2021

0600368.5
1100204.5

10-02-2021

1100207.2M001
1100207.2M002
1100208.4M003
1100208.4M004
1600237.0



香港特別行政區政府知識產權署外觀設計註冊處

The Government of the Hong Kong Special Administrative Region

Designs Registry, Intellectual Property Department

根據註冊外觀設計規則第 31 條刪除的註冊外觀設計。各組記項按註冊外觀設計刪除日期及註冊編號先後次序排列。

Registered designs removed under section 31 of the Registered Designs Rules. Entries are listed below under their removal dates.

09-04-2021 - 15-04-2021

09-04-2021	0501840.7M001
0011037.1M001	0501840.7M002
0011037.1M002	0501840.7M003
0501824.3M003	0600664.3M001
1001437.9	0600664.3M002
1501727.0	1001448.2
1501729.4	1001450.6
1501731.8	1501754.6M001
1501732.0M001	1501754.6M002
1501732.0M002	1501754.6M003
1501733.2M001	
1501733.2M002	
1501734.4	

14-04-2021

10-04-2021	1001455.7M001
1001444.3M001	1001455.7M002
1001444.3M002	1001455.7M003
1501739.5	1001456.9
1501740.7	1001457.1
1501741.9	1501759.7
1501742.1M001	1501760.9
1501742.1M002	1501761.1
1501743.3M001	1501763.5M003
1501743.3M002	1501763.5M004
1501745.8	

15-04-2021

11-04-2021	0501862.3M003
1501749.6	1501774.8M001
1501750.8	1501774.8M002
	1501775.1
	1501776.3
	1501777.5
12-04-2021	1501778.7
0011053.4	

13-04-2021



香港特別行政區政府知識產權署外觀設計註冊處

The Government of the Hong Kong Special Administrative Region

Designs Registry, Intellectual Property Department

根據註冊外觀設計條例第 76 條，更正已提交文件中的錯誤

Correction of errors in filed documents under section 76 of the Registered Designs Ordinance

任何人士現可對下列更正錯誤的請求提出反對

Request for correction of errors now open to opposition

如任何人士意欲反對下列請求，則須在本官方公報刊登是項更正請求的日期起計的兩個月內，根據註冊外觀設計規則第 62(4) 條，採用指明外觀設計表格第 D9 號提交反對通知。如在限期內沒有收到任何反對通知，處長將依本公報刊登的更正請求的內容，准許是項更正請求。

If any person wishes to oppose the following request, he shall file a notice of opposition in specified Designs Form D9 within two months from the date of advertisement in this official journal under section 62(4) of the Registered Designs Rules. If no notice of opposition is received, the request for correction will be allowed by the Registrar in the present advertised form.

請求更正外觀設計表格第 D1 號第 03 部分中申請人的姓名或名稱

Request made for correction of applicant's name in Part 03 of the Designs Form D1 filed

請求更正下列錯誤：

1. 增補漏記的根據註冊外觀設計條例第 16 條聲稱享有的優先權及
2. 在外觀設計表格第 D1 號第 08 部分增補優先權申請提交日期、國家及編號。

Request made for correction of the following errors:

1. addition of a priority claim under section 16 of the Registered Designs Ordinance; and
2. addition of the priority application date, country and number to Part 08 of the Designs Form D1 filed.

[21] 2117513.2M001

[30] 01.08.2020 / EU / 008062731

[21] 2117663.9

[71] 香港職業治療學會有限公司

Hong Kong Occupational Therapy Association Limited

[21] 2117664.1M001-M004

[71] 香港職業治療學會有限公司

Hong Kong Occupational Therapy Association Limited