

香港知識產權公報

Hong Kong Intellectual Property Journal

2021年7月30日

30 July 2021

目錄 Contents

根據註冊外觀設計條例第 25 條註冊的外觀設計

Designs Registered under section 25 of the Registered Designs Ordinance

按註冊編號排列

Arranged by Registration Number

根據註冊外觀設計條例(第 522 章)公布的其他公告

Other Notices Published under the Registered Designs Ordinance (Cap. 522)

根據註冊外觀設計條例第 28 條，註冊外觀設計因未繳續期費而停止有效

Registered designs ceased through non-payment of renewal fees under section 28 of the Registered Designs Ordinance

根據註冊外觀設計規則第 31 條刪除的註冊外觀設計

Registered designs removed under section 31 of the Registered Designs Rules

以下事項沒有記錄

No Records for the Following Matters

根據註冊外觀設計條例第 30 條放棄的外觀設計的註冊

Surrender of Registration of Design under section 30 of the Registered Designs Ordinance

根據註冊外觀設計規則第 37 條，向處長作出轉介

Reference to Registrar under section 37 of the Registered Designs Rules

根據註冊外觀設計條例第 45 條，撤銷註冊

Revocation of Registration under section 45 of the Registered Designs Ordinance

根據註冊外觀設計規則第 46 條，向法院作出轉介

Reference to Court under section 46 of the Registered Designs Rules

根據註冊外觀設計規則第 63 條對不符合規定之處作出糾正

Rectification of Irregularities under section 63 of the Registered Designs Rules

根據註冊外觀設計條例第 66 條，糾正註冊紀錄冊

Rectification of Register under section 66 of the Registered Designs Ordinance

根據註冊外觀設計條例第 67 條 更正註冊紀錄冊內的錯誤

Correction of errors in Register under section 67 of the Registered Designs Ordinance

根據註冊外觀設計條例第 67 及 76 條，更正註冊紀錄冊內及已提交文件中的錯誤

Correction of Errors in Register and in Filed Documents under sections 67 and 76 of the Registered Designs Ordinance

根據註冊外觀設計條例第 76 條，更正已提交文件中的錯誤

Correction of errors in filed documents under section 76 of the Registered Designs Ordinance

勘誤

Corrigendum

註冊外觀設計公告註釋

Notes on advertisements of registration of designs

方括號表示下列資料：

Square brackets indicate the following data：

[11] 註冊編號 Registration number / 聯合王國註冊編號 United Kingdom registration number

[15] 註冊日期 Registration date / 當作註冊日期 Deemed registration date / 聯合王國註冊日期 United Kingdom registration date

[17] 註冊有效期屆滿日期 Expiry date of the period of registration

[22] 提交日期 Filing date / 當作提交日期 Deemed filing date / 聯合王國提交日期 United Kingdom filing date

[30] 聲稱享有的優先權（提交日期 / 巴黎公約國或世界貿易組織成員 / 申請編號） Priority claimed (filing date / Paris Convention country or WTO member / application number)

[51] 國際外觀設計分類號（洛迦諾分類號） International Classification of designs (Locarno Classification)

[54] 物品 Article

[55] 外觀設計的表述 Representation of the design

[62] 分開前的申請編號及提交日期 Application number before division and filing date

[66] 過往註冊的聯繫外觀設計註冊編號 / 日期 Registration No. / Date of Previous Registration for Association

[72] 設計人 Designer

[73] 擁有人姓名和地址 Name and address of the owner

[74] 代理人 Agent /送達地址 Address for service



香港特別行政區政府知識產權署外觀設計註冊處
The Government of the Hong Kong Special Administrative Region
Designs Registry, Intellectual Property Department

根據註冊外觀設計條例第 25 條註冊的外觀設計

Designs registered under section 25 of the Registered Designs Ordinance

按註冊編號排列

Arranged by Registration Number

- [11] 2117591.6
- [15] 17-02-2021
- [30] 18-08-2020 / DE / 40 2020 100 783.8
- [51] Cl. 21-01
- [54] 玩具車
Toy vehicle
- [73] VOLKSWAGEN AKTIENGESELLSCHAFT
Berliner Ring 2,
38440 Wolfsburg,
Germany
- [74] CHINA PATENT AGENT (HONG KONG) LIMITED
22/F, Great Eagle Centre,
23 Harbour Road,
Wanchai, Hong Kong



-
- [11] 2117594.2
 - [15] 17-02-2021
 - [30] 18-08-2020 / DE / 40 2020 100 783.8
 - [51] Cl. 12-08

[54] 汽車

Motor vehicle

[73] VOLKSWAGEN AKTIENGESELLSCHAFT

Berliner Ring 2,
38440 Wolfsburg,
Germany

[74] CHINA PATENT AGENT (HONG KONG) LIMITED

22/F, Great Eagle Centre,
23 Harbour Road,
Wanchai, Hong Kong



[11] 2117609.6

[15] 19-02-2021

[30] 25-08-2020 / US / 29/747,712

[51] Cl. 16-06

[54] 射擊瞄準具照門

Gun sight

[73] MAGPUL INDUSTRIES CORP

8226 Bee Caves Road,
Austin, TX, 78746,
United States

[74] TRADEMARKCN COMPANY LIMITED

Block A, 4/F., Granville Building,
14 Granville Road,
Tsim Sha Tsui, Kowloon, Hong Kong

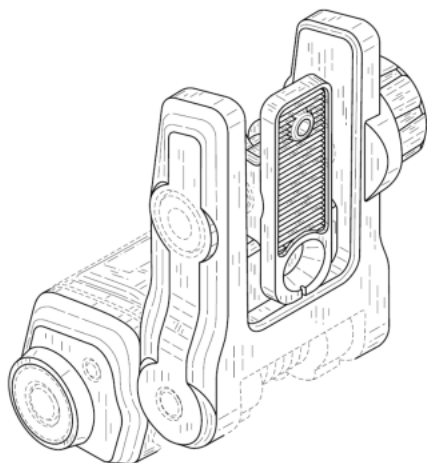

[11] 2117610.8

[15] 19-02-2021

[30] 25-08-2020 / US / 29/747,710

[51] Cl. 16-06

[54] 射擊瞄準具準星
Gun sight

[73] MAGPUL INDUSTRIES CORP
8226 Bee Caves Road,
Austin, TX, 78746,
United States

[74] TRADEMARKCN COMPANY LIMITED
Block A, 4/F., Granville Building,
14 Granville Road,
Tsim Sha Tsui, Kowloon, Hong Kong

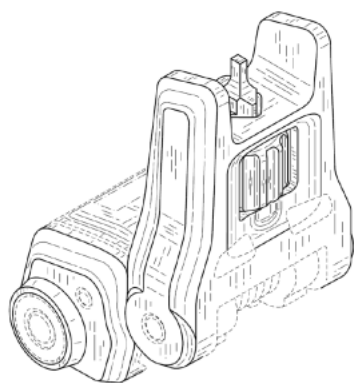

[11] 2117655.3M001

[15] 03-03-2021

[30] 15-09-2020 / EU / 008171334

[51] Cl. 14-04

- [54] 動態圖形用戶界面
Animated graphical user interface
- [73] Koninklijke Philips N.V.
High Tech Campus 52,
5656 AG Eindhoven,
Netherlands
- [74] Rouse & Co. International (Overseas) Limited
26th Floor, Tesbury Centre
28 Queen's Road East, Wan Chai
Hong Kong



-
- [11] 2117655.3M002
- [15] 03-03-2021
- [30] 15-09-2020 / EU / 008171334
- [51] Cl. 14-04
- [54] 動態圖形用戶界面
Animated graphical user interface
- [73] Koninklijke Philips N.V.
High Tech Campus 52,
5656 AG Eindhoven,
Netherlands
- [74] Rouse & Co. International (Overseas) Limited
26th Floor, Tesbury Centre
28 Queen's Road East, Wan Chai
Hong Kong



[11] 2117655.3M003

[15] 03-03-2021

[30] 15-09-2020 / EU / 008171334

[51] Cl. 14-04

[54] 動態圖形用戶界面

Animated graphical user interface

[73] Koninklijke Philips N.V.

High Tech Campus 52,

5656 AG Eindhoven,

Netherlands

[74] Rouse & Co. International (Overseas) Limited

26th Floor, Tesbury Centre

28 Queen's Road East, Wan Chai

Hong Kong



[11] 2117655.3M004

[15] 03-03-2021

[30] 15-09-2020 / EU / 008171334

- [51] Cl. 14-04
- [54] 動態圖形用戶界面
Animated graphical user interface
- [73] Koninklijke Philips N.V.
High Tech Campus 52,
5656 AG Eindhoven,
Netherlands
- [74] Rouse & Co. International (Overseas) Limited
26th Floor, Tesbury Centre
28 Queen's Road East, Wan Chai
Hong Kong

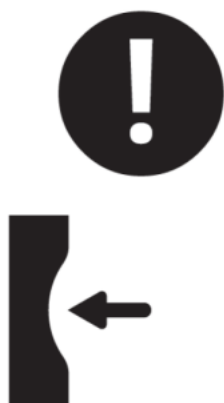

-
- [11] 2117655.3M005
- [15] 03-03-2021
- [30] 15-09-2020 / EU / 008171334
- [51] Cl. 14-04
- [54] 動態圖形用戶界面
Animated graphical user interface
- [73] Koninklijke Philips N.V.
High Tech Campus 52,
5656 AG Eindhoven,
Netherlands
- [74] Rouse & Co. International (Overseas) Limited
26th Floor, Tesbury Centre
28 Queen's Road East, Wan Chai
Hong Kong



[11] 2117655.3M006

[15] 03-03-2021

[30] 15-09-2020 / EU / 008171334

[51] Cl. 14-04

[54] 動態圖形用戶界面

Animated graphical user interface

[73] Koninklijke Philips N.V.

High Tech Campus 52,

5656 AG Eindhoven,

Netherlands

[74] Rouse & Co. International (Overseas) Limited

26th Floor, Tesbury Centre

28 Queen's Road East, Wan Chai

Hong Kong



- [11] 2117655.3M007
- [15] 03-03-2021
- [30] 15-09-2020 / EU / 008171334
- [51] Cl. 14-04
- [54] 動態圖形用戶界面
Animated graphical user interface
- [73] Koninklijke Philips N.V.
High Tech Campus 52,
5656 AG Eindhoven,
Netherlands
- [74] Rouse & Co. International (Overseas) Limited
26th Floor, Tesbury Centre
28 Queen's Road East, Wan Chai
Hong Kong



-
- [11] 2117655.3M008
 - [15] 03-03-2021
 - [30] 15-09-2020 / EU / 008171334
 - [51] Cl. 14-04
 - [54] 動態圖形用戶界面
Animated graphical user interface
 - [73] Koninklijke Philips N.V.
High Tech Campus 52,
5656 AG Eindhoven,
Netherlands
 - [74] Rouse & Co. International (Overseas) Limited
26th Floor, Tesbury Centre
28 Queen's Road East, Wan Chai
Hong Kong



- [11] 2117655.3M009
[15] 03-03-2021
[30] 15-09-2020 / EU / 008171334
[51] Cl. 14-04
[54] 動態圖形用戶界面
Animated graphical user interface
[73] Koninklijke Philips N.V.
High Tech Campus 52,
5656 AG Eindhoven,
Netherlands
[74] Rouse & Co. International (Overseas) Limited
26th Floor, Tesbury Centre
28 Queen's Road East, Wan Chai
Hong Kong



-
- [11] 2117655.3M010
[15] 03-03-2021
[30] 15-09-2020 / EU / 008171334
[51] Cl. 14-04
[54] 動態圖形用戶界面
Animated graphical user interface
[73] Koninklijke Philips N.V.
High Tech Campus 52,
5656 AG Eindhoven,
Netherlands
[74] Rouse & Co. International (Overseas) Limited
26th Floor, Tesbury Centre
28 Queen's Road East, Wan Chai
Hong Kong



-
- [11] 2117655.3M011
[15] 03-03-2021
[30] 15-09-2020 / EU / 008171334
[51] Cl. 14-04
[54] 動態圖形用戶界面
Animated graphical user interface
[73] Koninklijke Philips N.V.
High Tech Campus 52,
5656 AG Eindhoven,
Netherlands
[74] Rouse & Co. International (Overseas) Limited
26th Floor, Tesbury Centre
28 Queen's Road East, Wan Chai
Hong Kong



-
- [11] 2117679.3
[15] 10-03-2021
[30] 11-09-2020 / JP / 019478 of 2020
[51] Cl. 10-04
[54] 身體組分測量儀
Body composition meter
[73] 株式會社百利達
TANITA CORPORATION
1-14-2, Maeno-Cho, Itabashi-Ku,
Tokyo 174-8630,
Japan
[74] CHANG TSI AND PARTNERS INTELLECTUAL PROPERTY (HK) LIMITED
Level 19, Two International Finance Centre,

8 Finance Street,
Central, Hong Kong

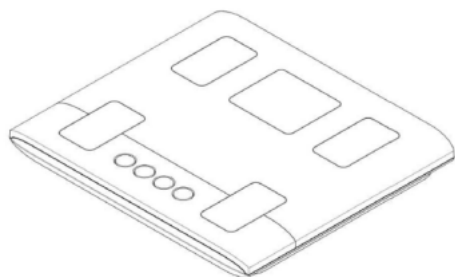

-
- [11] 2117699.5
[15] 15-03-2021
[30] 16-09-2020 / EU / 008169544-0001
[51] Cl. 21-01
[54] 模型車
Model Car
[73] Dr. Ing. h.c. F. Porsche Aktiengesellschaft
Porscheplatz 1
70435 Stuttgart
Germany
[74] WENPING PATENT & TRADE MARK AGENT LIMITED
1701 Tung Wai Commercial Building,
111 Gloucester Road,
Hong Kong



-
- [11] 2117700.9M001
[15] 15-03-2021
[30] 16-09-2020 / EU / 008171789-0001
[51] Cl. 12-08

[54] 汽車

Automobile

[73] Dr. Ing. h.c. F. Porsche Aktiengesellschaft

Porscheplatz 1

70435 Stuttgart

Germany

[74] WENPING PATENT & TRADE MARK AGENT LIMITED

1701 Tung Wai Commercial Building,

111 Gloucester Road,

Hong Kong



[11] 2117700.9M002

[15] 15-03-2021

[30] 16-09-2020 / EU / 008171789-0006

[51] C1. 12-16

[54] 汽車擾流板

Spoiler for vehicles

[73] Dr. Ing. h.c. F. Porsche Aktiengesellschaft

Porscheplatz 1

70435 Stuttgart

Germany

[74] WENPING PATENT & TRADE MARK AGENT LIMITED

1701 Tung Wai Commercial Building,

111 Gloucester Road,

Hong Kong



- [11] 2117700.9M003
[15] 15-03-2021
[30] 16-09-2020 / EU / 008171789-0018
[51] Cl. 12-16
[54] 汽車進氣格柵
Air-intake grille for vehicle
[73] Dr. Ing. h.c. F. Porsche Aktiengesellschaft
Porscheplatz 1
70435 Stuttgart
Germany
[74] WENPING PATENT & TRADE MARK AGENT LIMITED
1701 Tung Wai Commercial Building,
111 Gloucester Road,
Hong Kong

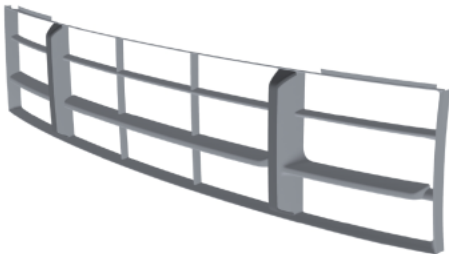

-
- [11] 2117700.9M004
[15] 15-03-2021
[30] 16-09-2020 / EU / 008171789-0017
[51] Cl. 12-16
[54] 汽車進氣格柵
Air-intake grille for vehicle
[73] Dr. Ing. h.c. F. Porsche Aktiengesellschaft
Porscheplatz 1
70435 Stuttgart
Germany
[74] WENPING PATENT & TRADE MARK AGENT LIMITED
1701 Tung Wai Commercial Building,
111 Gloucester Road,
Hong Kong

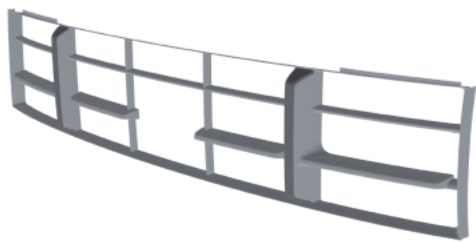

[11] 2117700.9M005

[15] 15-03-2021

[30] 16-09-2020 / EU / 008171789-0015

[51] Cl. 12-16

[54] 排氣管

Tailpipe

[73] Dr. Ing. h.c. F. Porsche Aktiengesellschaft

Porscheplatz 1

70435 Stuttgart

Germany

[74] WENPING PATENT & TRADE MARK AGENT LIMITED

1701 Tung Wai Commercial Building,

111 Gloucester Road,

Hong Kong

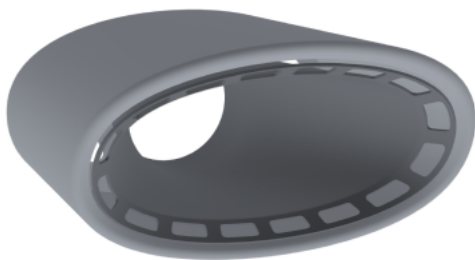

[11] 2117700.9M006

[15] 15-03-2021

[30] 16-09-2020 / EU / 008171789-0014

[51] Cl. 12-16

[54] 排氣管

Tailpipe

[73] Dr. Ing. h.c. F. Porsche Aktiengesellschaft
Porscheplatz 1
70435 Stuttgart
Germany

[74] WENPING PATENT & TRADE MARK AGENT LIMITED
1701 Tung Wai Commercial Building,
111 Gloucester Road,
Hong Kong

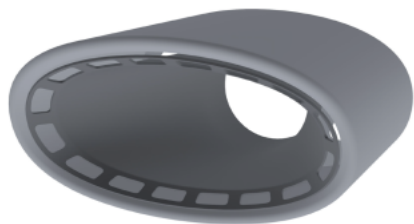

[11] 2117700.9M007

[15] 15-03-2021

[30] 16-09-2020 / EU / 008171789-0009

[51] Cl. 12-16

[54] 汽車車身零件

Body part for vehicles

[73] Dr. Ing. h.c. F. Porsche Aktiengesellschaft
Porscheplatz 1
70435 Stuttgart
Germany

[74] WENPING PATENT & TRADE MARK AGENT LIMITED
1701 Tung Wai Commercial Building,
111 Gloucester Road,
Hong Kong



[11] 2117757.9M001

[15] 25-03-2021

[30] 02-10-2020 / US / 29/753,883

[51] Cl. 14-03

[54] 揚聲電話
Speakerphone

[73] 續特力股份有限公司
PLANTRONICS, INC.
345 Encinal St.,
Santa Cruz, CA 95060,
United States

[74] SHANGHAI INTELLECTUAL PROPERTY OFFICE
Unit F, 20th Floor, Neich Tower,
128 Gloucester Road,
Hong Kong

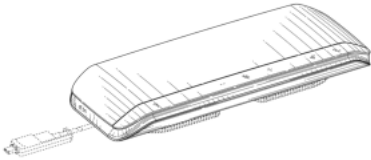

[11] 2117757.9M002

[15] 25-03-2021

[30] 02-10-2020 / US / 29/753,883

[51] Cl. 14-03

[54] 揚聲電話
Speakerphone

[73] 續特力股份有限公司
PLANTRONICS, INC.
345 Encinal St.,
Santa Cruz, CA 95060,
United States

[74] SHANGHAI INTELLECTUAL PROPERTY OFFICE
Unit F, 20th Floor, Neich Tower,
128 Gloucester Road,
Hong Kong

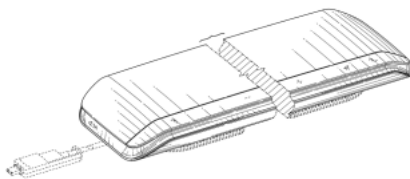

- [11] 2117757.9M003
[15] 25-03-2021
[30] 02-10-2020 / US / 29/753,883
[51] Cl. 14-03
[54] 揚聲電話
Speakerphone
[73] 續特力股份有限公司
PLANTRONICS, INC.
345 Encinal St.,
Santa Cruz, CA 95060,
United States
[74] SHANGHAI INTELLECTUAL PROPERTY OFFICE
Unit F, 20th Floor, Neich Tower,
128 Gloucester Road,
Hong Kong

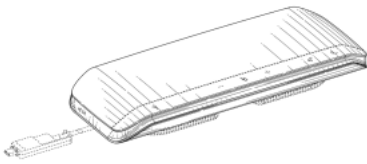

- [11] 2117757.9M004
[15] 25-03-2021
[30] 02-10-2020 / US / 29/753,883
[51] Cl. 14-03
[54] 揚聲電話
Speakerphone
[73] 續特力股份有限公司
PLANTRONICS, INC.
345 Encinal St.,
Santa Cruz, CA 95060,
United States
[74] SHANGHAI INTELLECTUAL PROPERTY OFFICE
Unit F, 20th Floor, Neich Tower,
128 Gloucester Road,
Hong Kong

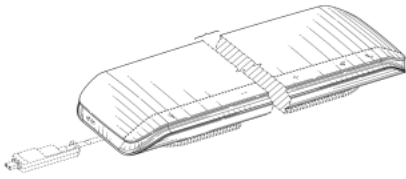

-
- [11] 2117757.9M005
[15] 25-03-2021
[30] 02-10-2020 / US / 29/753,883
[51] Cl. 14-03
[54] 揚聲電話
Speakerphone
[73] 續特力股份有限公司
PLANTRONICS, INC.
345 Encinal St.,
Santa Cruz, CA 95060,
United States
[74] SHANGHAI INTELLECTUAL PROPERTY OFFICE
Unit F, 20th Floor, Neich Tower,
128 Gloucester Road,
Hong Kong

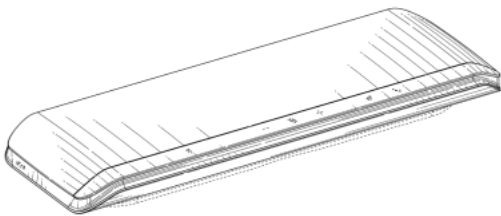

-
- [11] 2117757.9M006
[15] 25-03-2021
[30] 02-10-2020 / US / 29/753,883
[51] Cl. 14-03
[54] 揚聲電話
Speakerphone
[73] 續特力股份有限公司
PLANTRONICS, INC.
345 Encinal St.,
Santa Cruz, CA 95060,
United States
[74] SHANGHAI INTELLECTUAL PROPERTY OFFICE
Unit F, 20th Floor, Neich Tower,

128 Gloucester Road,
Hong Kong

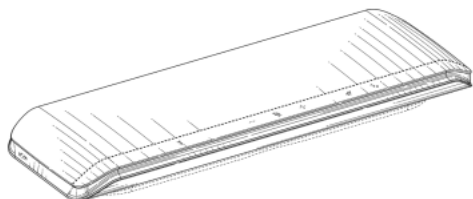

-
- [11] 2117757.9M007
 - [15] 25-03-2021
 - [30] 02-10-2020 / US / 29/753,883
 - [51] Cl. 14-03
 - [54] 揚聲電話
Speakerphone
 - [73] 繽特力股份有限公司
PLANTRONICS, INC.
345 Encinal St.,
Santa Cruz, CA 95060,
United States
 - [74] SHANGHAI INTELLECTUAL PROPERTY OFFICE
Unit F, 20th Floor, Neich Tower,
128 Gloucester Road,
Hong Kong

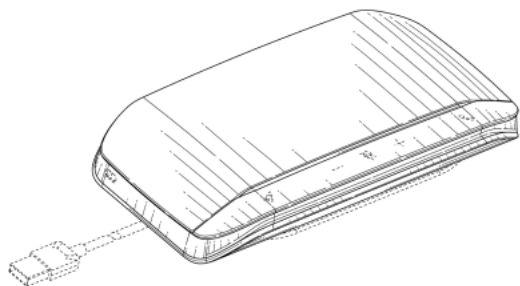

-
- [11] 2117757.9M008
 - [15] 25-03-2021
 - [30] 02-10-2020 / US / 29/753,883
 - [51] Cl. 14-03
 - [54] 揚聲電話
Speakerphone

[73] 續特力股份有限公司
PLANTRONICS, INC.
345 Encinal St.,
Santa Cruz, CA 95060,
United States

[74] SHANGHAI INTELLECTUAL PROPERTY OFFICE
Unit F, 20th Floor, Neich Tower,
128 Gloucester Road,
Hong Kong

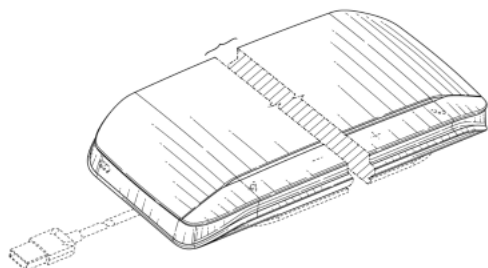

[11] 2117757.9M009

[15] 25-03-2021

[30] 02-10-2020 / US / 29/753,883

[51] Cl. 14-03

[54] 揚聲電話
Speakerphone

[73] 續特力股份有限公司
PLANTRONICS, INC.
345 Encinal St.,
Santa Cruz, CA 95060,
United States

[74] SHANGHAI INTELLECTUAL PROPERTY OFFICE
Unit F, 20th Floor, Neich Tower,
128 Gloucester Road,
Hong Kong

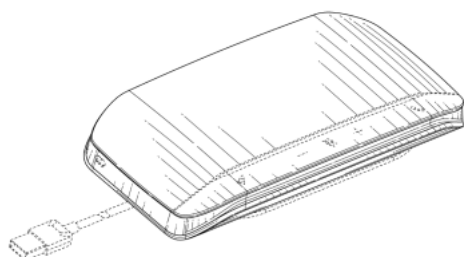

- [11] 2117757.9M010
[15] 25-03-2021
[30] 02-10-2020 / US / 29/753,883
[51] Cl. 14-03
[54] 揚聲電話
Speakerphone
[73] 繽特力股份有限公司
PLANTRONICS, INC.
345 Encinal St.,
Santa Cruz, CA 95060,
United States
[74] SHANGHAI INTELLECTUAL PROPERTY OFFICE
Unit F, 20th Floor, Neich Tower,
128 Gloucester Road,
Hong Kong

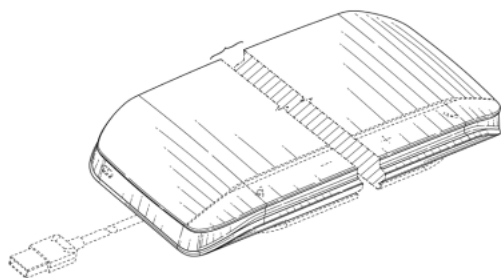

-
- [11] 2117780.7M001
[15] 31-03-2021
[51] Cl. 26-04
[54] 蠟燭
Candle
[73] LOEWE S.A.
Calle Goya 4,
E-28001 Madrid,
Spain
[74] WENPING PATENT & TRADE MARK AGENT LIMITED
1701 Tung Wai Commercial Building,
111 Gloucester Road,
Hong Kong



[11] 2117780.7M002

[15] 31-03-2021

[51] Cl. 26-01

[54] 燭台

Candlestick

[73] LOEWE S.A.

Calle Goya 4,

E-28001 Madrid,

Spain

[74] WENPING PATENT & TRADE MARK AGENT LIMITED

1701 Tung Wai Commercial Building,

111 Gloucester Road,

Hong Kong

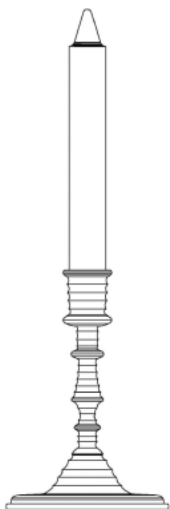

[11] 2117782.1M001

[15] 31-03-2021

[30] 16-12-2020 / CN / 202030776698.2

[51] Cl. 24-01

[54] 售藥機

Medicine collection machine

[73] UMP Healthcare Medical Technology (Hainan) Limited

5001, 2/F, Building A17,
Hainan Ecology Software Park,
High-tech Industry Demonstration Zone,
Laochengzhen, Chengmai County,
Hainan Province,
China

[74] DEACONS

5th Floor, Alexandra House,
Central,
Hong Kong

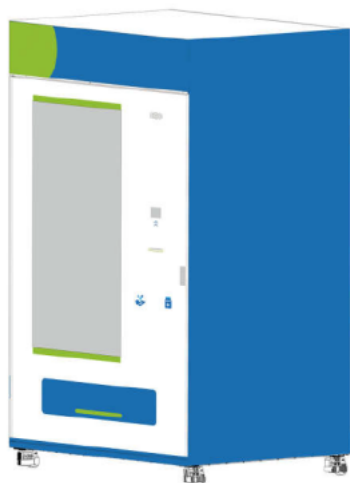

[11] 2117782.1M002

[15] 31-03-2021

[30] 16-12-2020 / CN / 202030776700.6

[51] Cl. 24-01

[54] 問診機

Teleconsultation machine

[73] UMP Healthcare Medical Technology (Hainan) Limited

5001, 2/F, Building A17,
Hainan Ecology Software Park,
High-tech Industry Demonstration Zone,
Laochengzhen, Chengmai County,
Hainan Province,
China

[74] DEACONS

5th Floor, Alexandra House,
Central,
Hong Kong

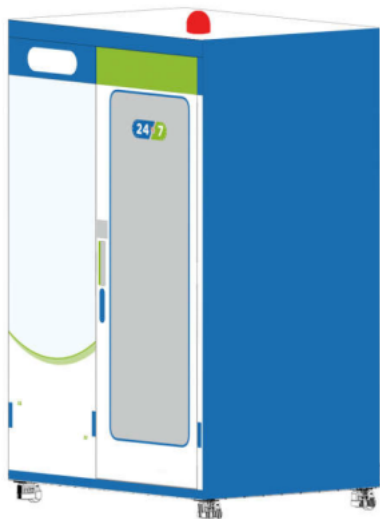

[11] 2117821.5

[15] 08-04-2021

[51] Cl. 29-02

[54] 口罩之部分

A part of the mask

[73] 中國衛生材料生產中心股份有限公司

台灣

彰化縣彰化市彰南路六段

424 巷 21 號

[74] 香港匯澤知識產權代理有限公司

香港九龍

尖沙咀廣東道 5 號

海港城海洋中心 8 樓 826 室

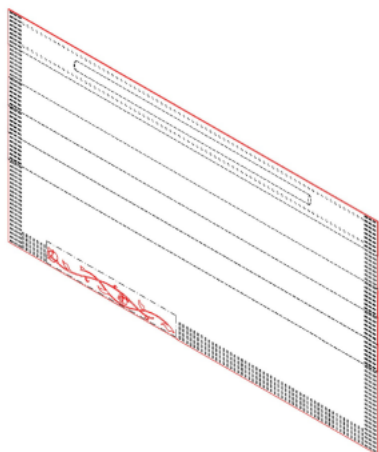

[11] 2117822.7

[15] 08-04-2021

[51] C1. 29-02

[54] 口罩之部分

A part of the mask

[73] 中國衛生材料生產中心股份有限公司

台灣

彰化縣彰化市彰南路六段

424 巷 21 號

[74] 香港匯澤知識產權代理有限公司

香港九龍

尖沙咀廣東道 5 號

海港城海洋中心 8 樓 826 室

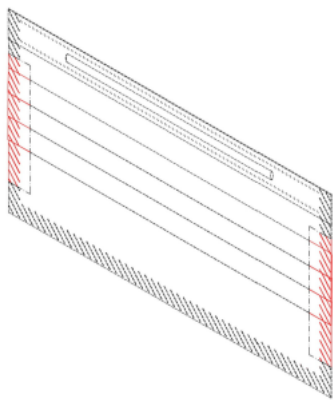

[11] 2117823.9

[15] 08-04-2021

[51] C1. 29-02

[54] 口罩之部分

A part of the mask

[73] 中國衛生材料生產中心股份有限公司

台灣

彰化縣彰化市彰南路六段

424 巷 21 號

[74] 香港匯澤知識產權代理有限公司

香港九龍

尖沙咀廣東道 5 號

海港城海洋中心 8 樓 826 室

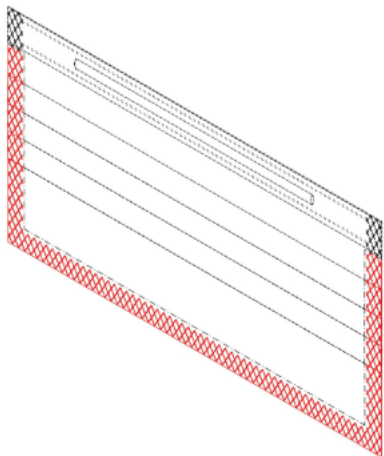

[11] 2117999.1

[15] 12-05-2021

[30] 12-11-2020 / FR / 2020-5124

[51] Cl. 11-01

[54] 首飾

Jewellery

[73] LOUIS VUITTON MALLETIER

2 rue du Pont-Neuf,

75001 Paris,

France

[74] BAKER & MCKENZIE

14th Floor, One Taikoo Place,

979 King's Road,

Quarry Bay, Hong Kong

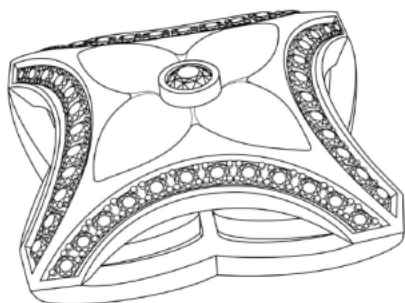

[11] 2118000.5

[15] 12-05-2021

[30] 12-11-2020 / FR / 2020-5117

[51] Cl. 11-01

[54] 首飾
Jewellery

[73] LOUIS VUITTON MALLETIER
2 rue du Pont-Neuf,
75001 Paris,
France

[74] BAKER & MCKENZIE
14th Floor, One Taikoo Place,
979 King's Road,
Quarry Bay, Hong Kong



[11] 2118020.7

[15] 17-05-2021

[30] 17-11-2020 / FR / 2020-5181

[51] Cl. 11-01

[54] 首飾
Jewellery

[73] LOUIS VUITTON MALLETIER
2 rue du Pont-Neuf,
75001 Paris,
France

[74] BAKER & MCKENZIE
14th Floor, One Taikoo Place,
979 King's Road,
Quarry Bay, Hong Kong

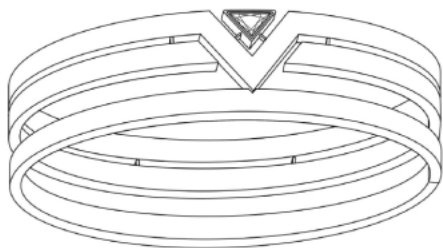

-
- [11] 2118021.9
[15] 17-05-2021
[30] 17-11-2020 / FR / 2020-5188
[51] Cl. 11-01
[54] 首飾
Jewellery
[73] LOUIS VUITTON MALLETIER
2 rue du Pont-Neuf,
75001 Paris,
France
[74] BAKER & MCKENZIE
14th Floor, One Taikoo Place,
979 King's Road,
Quarry Bay, Hong Kong



-
- [11] 2118024.5
[15] 18-05-2021
[30] 02-12-2020 / EU / 008306401-0002
[51] Cl. 14-01

[54] 耳機

Audio headset

[73] 一兆聲學科技（深圳）有限公司

YI ZHAO (SHENZHEN) CO., LIMITED

中國內地

深圳市寶安區航城街道草圍社區寶安大道 5010 號

深圳多彩匯威文化創意博覽城 T3 創意大廈 6 層 609-610 號

[74] 滙誠知識產權有限公司

香港

灣仔軒尼詩道 8-12 號

中港大廈 8 樓



[11] 2118025.8

[15] 18-05-2021

[30] 02-12-2020 / EU / 008306401-0004

[51] Cl. 14-01

[54] 耳機

Audio headset

[73] 一兆聲學科技（深圳）有限公司

YI ZHAO (SHENZHEN) CO., LIMITED

中國內地

深圳市寶安區航城街道草圍社區寶安大道 5010 號

深圳多彩匯威文化創意博覽城 T3 創意大廈 6 層 609-610 號

[74] 滙誠知識產權有限公司

香港

灣仔軒尼詩道 8-12 號

中港大廈 8 樓



[11] 2118026.0

[15] 18-05-2021

[30] 02-12-2020 / EU / 008306401-0003

[51] Cl. 14-01

[54] 耳機

Audio headset

[73] 一兆聲學科技(深圳)有限公司

YI ZHAO (SHENZHEN) CO., LIMITED

中國內地

深圳市寶安區航城街道草圍社區寶安大道 5010 號

深圳多彩匯威文化創意博覽城 T3 創意大廈 6 層 609-610 號

[74] 滙誠知識產權有限公司

香港

灣仔軒尼詩道 8-12 號

中港大廈 8 樓



- [11] 2118027.2
[15] 18-05-2021
[30] 02-12-2020 / EU / 008306401-0005
[51] Cl. 14-01
[54] 耳機
Audio headset
[73] 一兆聲學科技(深圳)有限公司
YI ZHAO (SHENZHEN) CO., LIMITED
中國內地
深圳市寶安區航城街道草圍社區寶安大道 5010 號
深圳多彩匯威文化創意博覽城 T3 創意大廈 6 層 609-610 號
[74] 滙誠知識產權有限公司
香港
灣仔軒尼詩道 8-12 號
中港大廈 8 樓



-
- [11] 2118028.4
[15] 18-05-2021
[30] 02-12-2020 / EU / 008306401-0006
[51] Cl. 14-01
[54] 耳機
Audio headset
[73] 一兆聲學科技(深圳)有限公司
YI ZHAO (SHENZHEN) CO., LIMITED
中國內地
深圳市寶安區航城街道草圍社區寶安大道 5010 號
深圳多彩匯威文化創意博覽城 T3 創意大廈 6 層 609-610 號

- [74] 滙誠知識產權有限公司
香港
灣仔軒尼詩道 8-12 號
中港大廈 8 樓



-
- [11] 2118061.3
[15] 25-05-2021
[30] 25-11-2020 / US / 29/759,912
[51] Cl. 14-04
[54] 支持圖形用戶界面的顯示屏幕或其部分
Display screen or portion thereof supporting a graphical user interface
[73] DACADOO AG
Othmarstrasse 8 Zurich,
Switzerland
[74] TRADEMARKCN COMPANY LIMITED
Block A, 4/F., Granville Building,
14 Granville Road,
Tsim Sha Tsui, Kowloon, Hong Kong

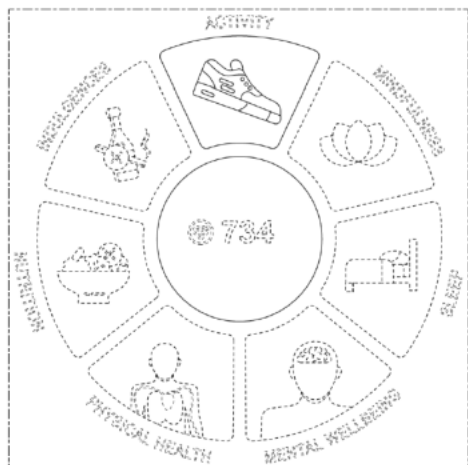



香港特別行政區政府知識產權署外觀設計註冊處

The Government of the Hong Kong Special Administrative Region

Designs Registry, Intellectual Property Department

根據註冊外觀設計條例第 28 條，下列註冊外觀設計因未繳續期費而停止有效。

各組記項按註冊外觀設計停止有效日期及註冊編號先後次序排列。

Registered designs ceased through non-payment of renewal fees under section 28 of the Registered Designs Ordinance. Entries are listed below under their expiry dates.

07-05-2021 - 11-05-2021

07-05-2021	1600894.2
0601229.2	1600895.5M001
	1600895.5M002
08-05-2021	1600895.5M003
1100772.9M001	1600895.5M004
1100772.9M002	1600895.5M005
1100775.6M001	1600898.1
1100775.6M003	
1100775.6M004	11-05-2021
1100777.0	0601270.8M001
1100779.4	1100790.7M001
1600867.6M001	1100790.7M002
1600867.6M002	1100790.7M003
1600873.8M006	1100790.7M004
1600873.8M007	1100793.3M001
1600873.8M008	1100794.5M001
1600874.0	1100795.8
	1100798.4
09-05-2021	1600900.7M001
0601256.9	1600900.7M002
0601257.1	1600900.7M003
1600887.8	1600903.3
1600888.0	1600905.8
1600889.2	1600906.0M001
	1600906.0M002
10-05-2021	1600907.2M001
0601264.5	1600907.2M002
1100783.2M001	1600909.6
1100783.2M002	1600910.8
1100785.7	1600913.4
1600890.4	1600914.6
1600891.6	
1600892.8	
1600893.0	



香港特別行政區政府知識產權署外觀設計註冊處

The Government of the Hong Kong Special Administrative Region

Designs Registry, Intellectual Property Department

根據註冊外觀設計規則第 31 條刪除的註冊外觀設計。各組記項按註冊外觀設計刪除日期及註冊編號先後次序排列。

Registered designs removed under section 31 of the Registered Designs Rules. Entries are listed below under their removal dates.

09-07-2021 - 14-07-2021

09-07-2021	1502405.8	1502424.7M001
0011624.6M003	1502406.0	1502424.7M002
	1502407.2M001	1502425.0
10-07-2021	1502407.2M002	
0502696.2M001	1502407.2M003	
1002046.1	1502408.4M001	
1002047.3	1502408.4M002	
1002049.7	1502408.4M003	
	1502409.6M001	
11-07-2021	1502409.6M002	
0502707.7	1502409.6M003	
0502708.9	1502409.6M004	
0502709.1	1502410.8	
1002059.8		
1002062.4	13-07-2021	
1502391.6	1002087.7M001	
1502395.5	1002087.7M002	
1502396.7	1002088.9M001	
1502398.1M001	1002088.9M002	
1502398.1M002	1002090.3M002	
1502398.1M003	1002093.9	
1502398.1M004	1502414.6M001	
1502398.1M007	1502416.1M001	
1502400.7	1502416.1M002	
	1502416.1M003	
12-07-2021	1502417.3	
1002070.1		
1002071.3	14-07-2021	
1002073.7	1002100.6	
1002074.9	1002102.0	
1002076.4	1502419.7	
1502401.9	1502420.9	
1502402.1	1502421.1	
1502403.3	1502422.3	