

香港知識產權公報

Hong Kong Intellectual Property Journal

2019 年 8 月 30 日

30 August 2019



目錄 Contents

根據註冊外觀設計條例第 25 條註冊的外觀設計

Designs Registered under section 25 of the Registered Designs Ordinance

[按註冊編號排列](#)

[Arranged by Registration Number](#)

根據註冊外觀設計條例(第 522 章)公布的其他公告

Other Notices Published under the Registered Designs Ordinance (Cap. 522)

[根據註冊外觀設計條例第 28 條，註冊外觀設計因未繳續期費而停止有效](#)

[Registered designs ceased through non-payment of renewal fees under section 28 of the Registered Designs Ordinance](#)

[根據註冊外觀設計規則第 31 條刪除的註冊外觀設計](#)

[Registered designs removed under section 31 of the Registered Designs Rules](#)

以下事項沒有記錄

No Records for the Following Matters

[根據註冊外觀設計條例第 30 條放棄的外觀設計的註冊](#)

[Surrender of Registration of Design under section 30 of the Registered Designs Ordinance](#)

[根據註冊外觀設計規則第 37 條，向處長作出轉介](#)

[Reference to Registrar under section 37 of the Registered Designs Rules](#)

[根據註冊外觀設計條例第 45 條，撤銷註冊](#)

[Revocation of Registration under section 45 of the Registered Designs Ordinance](#)

根據註冊外觀設計規則第 46 條，向法院作出轉介

Reference to Court under section 46 of the Registered Designs Rules

根據註冊外觀設計規則第 63 條對不符合規定之處作出糾正

Rectification of Irregularities under section 63 of the Registered Designs Rules

根據註冊外觀設計條例第 66 條，糾正註冊紀錄冊

Rectification of Register under section 66 of the Registered Designs Ordinance

根據註冊外觀設計條例第 67 條，更正註冊紀錄冊內的錯誤

Correction of Errors in Register under section 67 of the Registered Designs Ordinance

根據註冊外觀設計條例第 67 及 76 條，更正註冊紀錄冊內及已提交文件中的錯誤

Correction of Errors in Register and in Filed Documents under sections
67 and 76 of the Registered Designs Ordinance

根據註冊外觀設計條例第 76 條，更正已提交文件中的錯誤

Correction of Errors in Filed Documents under section 76 of the Registered Designs
Ordinance

勘誤

Corrigendum

註冊外觀設計公告註釋

Notes on advertisements of registration of designs

方括號表示下列資料：

Square brackets indicate the following data：

[11] 註冊編號 Registration number / 聯合王國註冊編號 United Kingdom registration number

[15] 註冊日期 Registration date / 當作註冊日期 Deemed registration date / 聯合王國註冊日期 United Kingdom registration date

[17] 註冊有效期屆滿日期 Expiry date of the period of registration

[22] 提交日期 Filing date / 當作提交日期 Deemed filing date / 聯合王國提交日期 United Kingdom filing date

[30] 聲稱享有的優先權 (提交日期 / 巴黎公約國或世界貿易組織成員 / 申請編號) Priority claimed (filing date / Paris Convention country or WTO member / application number)

[51] 國際外觀設計分類號 (洛迦諾分類號) International Classification of designs (Locarno Classification)

[54] 物品 Article

[55] 外觀設計的表述 Representation of the design

[62] 分開前的申請編號及提交日期 Application number before division and filing date

[66] 過往註冊的聯繫外觀設計註冊編號 / 日期 Registration No. / Date of Previous Registration for Association

[72] 設計人 Designer

[73] 擁有人姓名和地址 Name and address of the owner

[74] 代理人 Agent / 送達地址 Address for service



香港特別行政區政府知識產權署外觀設計註冊處

The Government of the Hong Kong Special Administrative Region

Designs Registry, Intellectual Property Department

根據註冊外觀設計條例第 25 條註冊的外觀設計

Designs registered under section 25 of the Registered Designs Ordinance

按註冊編號排列

Arranged by Registration Number

[11] 1802196.6M001

[15] 07-11-2018

[51] Cl. 5-05

[54] 用於寢具的圖案

Pattern for bedding

[73] Casablanca International Limited

香港新界 沙田火炭黃竹洋

街 9-13 號 仁興中心五樓

[74] Casablanca International Limited

香港新界 沙田火炭黃竹洋

街 9-13 號 仁興中心五樓



[11] 1802196.6M002

[15] 07-11-2018

[51] Cl. 5-05

[54] 用於寢具的圖案

Pattern for bedding

[73] Casablanca International Limited

香港新界 沙田火炭黃竹洋

街 9-13 號 仁興中心五樓

[74] Casablanca International Limited

香港新界 沙田火炭黃竹洋

街 9-13 號 仁興中心五樓



[11] 1802196.6M003

[15] 07-11-2018

[51] Cl. 5-05

[54] 用於寢具的圖案

Pattern for bedding

[73] Casablanca International Limited

香港新界 沙田火炭黃竹洋

街 9-13 號 仁興中心五樓

[74] Casablanca International Limited

香港新界 沙田火炭黃竹洋

街 9-13 號 仁興中心五樓



[11] 1802253.7M001

[15] 20-11-2018

[51] Cl. 27-06

[54] 香煙外觀包裝

Cigarette appearance packaging

[73] 香港見喜(集團)國際煙草有限公司

香港新界

沙田安心街 19 號

匯貿中心 13 字樓 10 室

[74] 趙莊強

香港新界 沙田安

心街 19 號

匯貿中心 13 字樓 10 室



[11] 1802253.7M002

[15] 20-11-2018

[51] Cl. 27-06

[54] 香煙外觀包裝

Cigarette appearance packaging

[73] 香港見喜(集團)國際煙草有限公司

香港新界

沙田安心街 19 號

匯貿中心 13 字樓 10 室

[74] 趙莊強

香港新界 沙田安

心街 19 號

匯貿中心 13 字樓 10 室



[11] 1802282.8

[15] 23-11-2018

[51] Cl. 14-04

[54] 中文字輸入法鍵盤外觀設計

Chinese character input method keyboard layout design

[73] LO TAK PING

FLAT 10B TOWER 2 ROBINSON HEIGHTS,

8 ROBINSON ROAD, MID-LEVELS,

CENTRAL, HONG KONG

[74] LO TAK PING

FLAT 10B TOWER 2 ROBINSON HEIGHTS,

8 ROBINSON ROAD, MID-LEVELS,

CENTRAL, HONG KONG



- [11] 1802334.9
- [15] 28-11-2018
- [30] 28-05-2018 / CN / 201830254800.5
- [51] Cl. 14-04
- [54] 用於手機的圖形用戶介面
Graphical user interface for mobile phones
- [73] 北京京東尚科信息技術有限公司
中國內地北京市
海澱區
知春路 76 號 8 層

北京京東世紀貿易有限公司 中
國內地北京市 北京經濟技術開
發區

科創十一街 18 號 C 座 2 層 201 室

- [74] 英賽嘉華（香港）知識產權有限公司
香港金鐘
金鐘道 89 號
力寶中心 2 座 5 樓 503 室

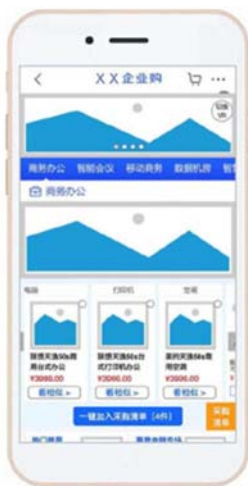

- [11] 1802335.2
- [15] 28-11-2018

- [30] 28-05-2018 / CN / 201830255932.X
- [51] Cl. 14-04
- [54] 用於手機的圖形用戶介面
Graphical user interface for mobile phones
- [73] 北京京東尚科信息技術有限公司
中國內地北京市
海澱區
知春路 76 號 8 層
- 北京京東世紀貿易有限公司 中
國內地北京市 北京經濟技術開
發區
科創十一街 18 號 C 座 2 層 201 室
- [74] 英賽嘉華（香港）知識產權有限公司
香港金鐘
金鐘道 89 號
力寶中心 2 座 5 樓 503 室



-
- [11] 1802523.1M001
- [15] 21-12-2018
- [30] 06-11-2018 / CN / 201830625800.1
- [51] Cl. 13-03
- [54] 多功能轉換器
Multi-functional adapter
- [73] 廣東高普達集團股份有限公司
中國內地廣東省深圳市
龍華新區大浪街道同勝社區華榮路 聯建
科技工業園廠房 8 棟 4,5,6 樓

- [74] 中一聯合國際知識產權有限公司
香港九龍尖沙咀
漆咸道南 45-51 號
其士大廈 803 室

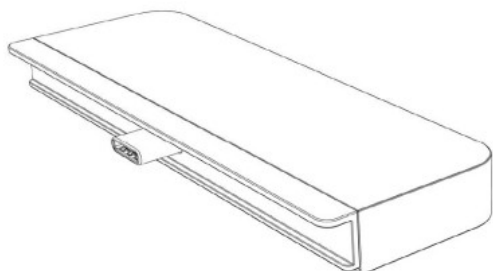

-
- [11] 1802523.1M002
[15] 21-12-2018
[30] 06-11-2018 / CN / 201830625800.1
[51] Cl. 13-03
[54] 多功能轉換器
Multi-functional adapter
[73] 廣東高普達集團股份有限公司
中國內地廣東省深圳市
龍華新區大浪街道同勝社區華榮路 聯建
科技工業園廠房 8 棟 4,5,6 樓
[74] 中一聯合國際知識產權有限公司
香港九龍尖沙咀
漆咸道南 45-51 號
其士大廈 803 室

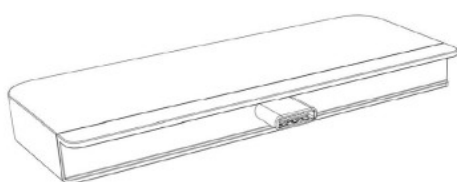

-
- [11] 1802531.8
[15] 21-12-2018
[51] Cl. 10-05
[54] 視覺智能安全合規監測系統
Visual intelligence safety compliance monitor system
[73] 緯衡科技有限公司
香港九龍九龍灣

臨興街 32 號

美羅中心一期 3 樓 301-312 室

[74] 緯衡科技有限公司 (經辦人: 溫凱麗)

香港九龍九龍灣

臨興街 32 號

美羅中心一期 3 樓 301-312 室



[11] 1900241.1M001

[15] 01-02-2019

[30] 30-08-2018 / EU, AL, MA, NO, OM, SG, CH, TN, UA, TR / DM/102
697

[51] Cl. 10-02

[54] 手錶

Wristwatch

[73] SWATCH AG (SWATCH SA) (SWATCH LTD.)

Jakob-Stämpfli-Strasse 94, CH-2502 Biel/Bienne,
SWITZERLAND

[74] Spruson & Ferguson (Hong Kong) Limited

5001 Hopewell Centre, 183 Queen's Road East, Hong Kong.



[11] 1900241.1M002

[15] 01-02-2019

[30] 30-08-2018 / EU, AL, MA, NO, OM, SG, CH, TN, UA, TR / DM/102
697

[51] Cl. 10-02

[54] 手錶

Wristwatch

[73] SWATCH AG (SWATCH SA) (SWATCH LTD.)

Jakob-Stämpfli-Strasse 94,

CH-2502 Biel/Bienne,

SWITZERLAND

[74] Spruson & Ferguson (Hong Kong) Limited

5001 Hopewell Centre,

183 Queen's Road East,

Hong Kong.



[11] 1900246.2M001

[15] 01-02-2019

[30] 30-08-2018 / EU, AL, MA, NO, OM, SG, CH, TN, UA, TR / DM/102
699

[51] Cl. 10-02

[54] 手錶

Wristwatch

[73] SWATCH AG (SWATCH SA) (SWATCH LTD.)

Jakob-Stämpfli-Strasse 94,

CH-2502 Biel/Bienne,

SWITZERLAND

[74] Spruson & Ferguson (Hong Kong) Limited

5001 Hopewell Centre,

183 Queen's Road East,

Hong Kong.



[11] 1900246.2M002

[15] 01-02-2019

[30] 30-08-2018 / EU, AL, MA, NO, OM, SG, CH, TN, UA, TR / DM/102
699

[51] Cl. 10-02

[54] 手錶

Wristwatch

[73] SWATCH AG (SWATCH SA) (SWATCH LTD.)

Jakob-Stämpfli-Strasse 94, CH-2502 Biel/Bienne,
SWITZERLAND

[74] Spruson & Ferguson (Hong Kong) Limited

5001 Hopewell Centre, 183 Queen's Road East, Hong Kong.



[11] 1900246.2M003

[15] 01-02-2019

[30] 30-08-2018 / EU, AL, MA, NO, OM, SG, CH, TN, UA, TR / DM/102
699

[51] Cl. 10-02

[54] 手錶

Wristwatch

[73] SWATCH AG (SWATCH SA) (SWATCH LTD.)

Jakob-Stämpfli-Strasse 94, CH-2502 Biel/Bienne,
SWITZERLAND

[74] Spruson & Ferguson (Hong Kong) Limited
5001 Hopewell Centre, 183 Queen's Road East, Hong Kong.



[11] 1900246.2M004

[15] 01-02-2019

[30] 30-08-2018 / EU, AL, MA, NO, OM, SG, CH, TN, UA, TR / DM/102
699

[51] Cl. 10-02

[54] 手錶

Wristwatch

[73] SWATCH AG (SWATCH SA) (SWATCH LTD.)
Jakob-Stämpfli-Strasse 94, CH-2502 Biel/Bienne,
SWITZERLAND

[74] Spruson & Ferguson (Hong Kong) Limited
5001 Hopewell Centre, 183 Queen's Road East, Hong Kong.



[11] 1900246.2M005

[15] 01-02-2019

[30] 30-08-2018 / EU, AL, MA, NO, OM, SG, CH, TN, UA, TR / DM/102
699

[51] Cl. 10-02

[54] 手錶

Wristwatch

[73] SWATCH AG (SWATCH SA) (SWATCH LTD.)
Jakob-Stämpfli-Strasse 94, CH-2502 Biel/Bienne,
SWITZERLAND

[74] Spruson & Ferguson (Hong Kong) Limited
5001 Hopewell Centre, 183 Queen's Road East, Hong Kong.



[11] 1913027.3

[15] 08-02-2019

[30] 08-08-2018 / US / 29/659,382

[51] Cl. 28-03

[54] 化妝工具和塗抹器

MAKEUP TOOL AND APPLICATOR

[73] Rea.deeming Beauty, Inc. dba beautyblender
3864 Courtney Street, Suite 190, Bethlehem, PA 18017,
UNITED STATES

[74] HNC INNOVATION LIMITED
Units 1205-1208, Cyberport 2,
No. 100 Cyberport Road, Hong Kong

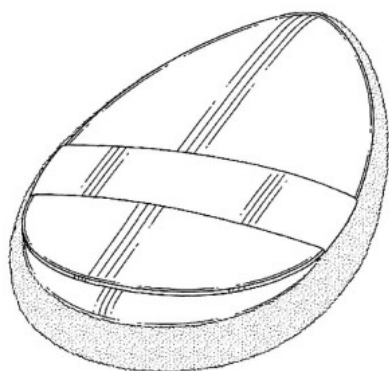

[11] 1913028.5

[15] 08-02-2019

[30] 07-08-2018 / US / 29/659,262

[51] Cl. 3-01

[54] 化妝海綿塗抹器盒

Container for cosmetic sponge applicator

[73] Rea.deeming Beauty

3864 Courtney Street, Suite 190, Bethlehem, PA 18017,
UNITED STATES

Inc. dba beautyblender

3864 Courtney Street, Suite 190, Bethlehem, PA 18017,
UNITED STATES

[74] HNC INNOVATION LIMITED

Units 1205-1208, Cyberport 2, No. 100 Cyberport Road, H.K.

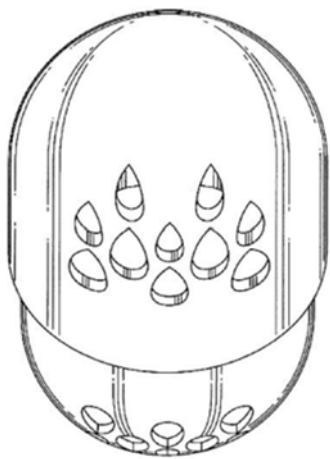

[11] 1913029.7

[15] 11-02-2019

[30] 09-08-2018 / NZ / 424815

[51] Cl. 6-03

[54] 桌

Table

[73] Furnware Limited

1128 Omaha Road,
Hastings 4175,
New Zealand

[74] Peter Shen & Co. Ltd

Suite 801, 8th Floor, K. Wah Centre,
191 Java Road, North Point,
Hong Kong

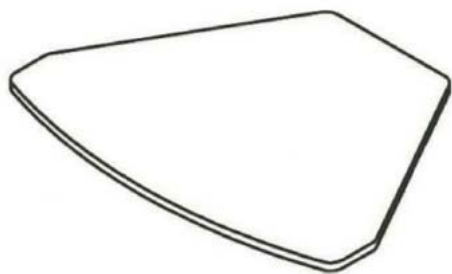

[11] 1913160.4

[15] 07-03-2019

[51] Cl. 9-03

[54] 包裝盒

Packaging box

[73] 學勤藥房有限公司

HOK KAN DISPENSARY LIMITED

香港

新界屯門 啟發徑 1/5 及 9/13 號 萬

成大廈地下 3 號舖

[74] UNIXION IP COMPANY LIMITED

香港

中環德輔道中 99-105 號

大新人壽大廈 2 樓



[11] 1913172.9

[15] 11-03-2019

[30] 20-12-2018 / CN / 201830741190.1

[51] Cl. 13-02

[54] 無線充電器

Wireless charger

[73] 傑美泰實業(深圳)有限公司

中國內地廣東省深圳市寶安區沙井街道

茅洲山工業園工業大廈 全至科技創新園科創大

廈 14 層 G

[74] 海思國際智慧財產權有限公司

香港

九龍旺角道 33

號凱途發展大廈 7 樓 04 室

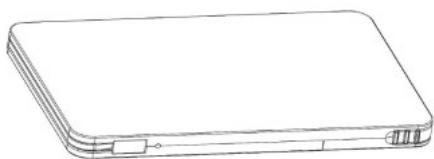

[11] 1913177.0

[15] 11-03-2019

[51] Cl. 9-01

[54] 水瓶

Water bottle

[73] HEAVEN SPRINGS DYNASTY HARVEST (GROUP) LIMITED

天泉鼎豐(集團)有限公司

香港

北角英皇道 499 號

4 樓 B 室

[74] 香港知識產權顧問有限公司

香港

新界荃灣德士古道 120 號

安泰國際中心 17 樓 01 室

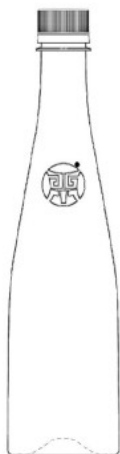

[11] 1913180.6

[15] 12-03-2019

[51] Cl. 8-08

[54] 螺母防鬆套

Lock nut cover

[73] 吳偉東

中國內地

廣東省揭陽市揭東區 玉湖鎮吳厝村寨外

向東圍二巷三十號

[74] C & H INT'L CONSULTANT LIMITED

香港

香港灣仔軒尼詩道 397 號

東區商業大廈 1206 室

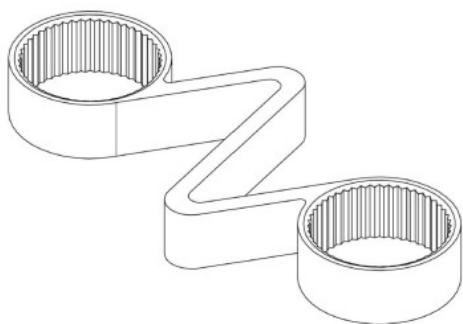

[11] 1913182.0

[15] 12-03-2019

[51] Cl. 13-02

[54] 移動電源

Power bank

- [73] 深圳派立通科技有限公司
Shenzhen Pilot technology Co.,LTD
中國內地 廣東省深圳市龍崗區平湖街道山廈社
區 杉坑工業區杉坑路 7 號 A1 廠房二樓、三樓
(在杉坑三路 B20 廠房一樓、三樓、四樓設有經營場所)
- [74] 中港專利有限公司
港灣道 1 號會展廣場辦公大樓 30 樓 3012 室
HONG KONG
HONG KONG



-
- [11] 1913183.2
[15] 12-03-2019
[51] Cl. 23-04
[54] 空氣淨化機
Air purifier
- [73] 真毅環境科技有限公司
GREEN BREEZE LIMITED
香港
新界沙田火炭坳背灣街 34-36 號 豐盛
工業中心 A 座 1108 室
- [74] 普衡知識產權代理有限公司
香港
上環永樂街 72-74 號 永
利大廈 9 字樓 C 室

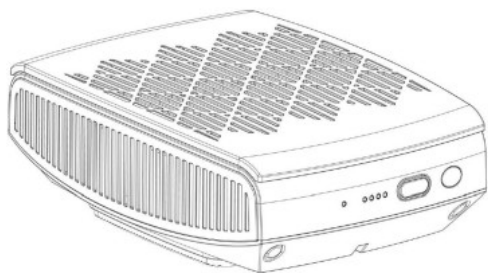

[11] 1913185.7

[15] 12-03-2019

[51] Cl. 21-01

[54] 玩具氣槍下身

Airsoft gun lower body

[73] 積企創品控股有限公司

JK Division Holdings Limited

RM5&6, 21/F, Prosper Commercial Building

9 Yin Chong Street, Mong Kok, Kowloon, Hong Kong

HONG KONG

[74] ACCOLADE IP LIMITED

10/F, Fu Fai Comm. Ctr.,

27 Hillier Street, Sheung Wan,

HONG KONG



[11] 1913186.9M001

[15] 12-03-2019

[30] 13-09-2018 / US / 29/663,312

[51] Cl. 14-03

[54] 通訊裝置用基座

Base unit for a communications device

[73] 續特力股份有限公司

PLANTRONICS, INC.

345 Encinal St., Santa Cruz, CA 95060

UNITED STATES

[74] SHANGHAI INTELLECTUAL PROPERTY OFFICE

Unit F, 20th Floor, Neich Tower,

128 Gloucester Road,

HONG KONG

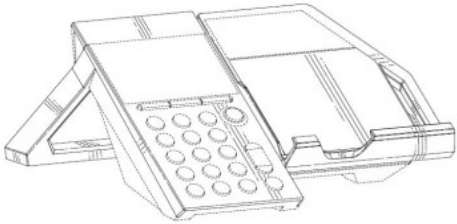

[11] 1913186.9M002

[15] 12-03-2019

[30] 13-09-2018 / US / 29/663,312

[51] Cl. 14-03

[54] 通訊裝置用基座

Base unit for a communications device

[73] 續特力股份有限公司

PLANTRONICS, INC.

345 Encinal St., Santa Cruz, CA 95060

UNITED STATES

[74] SHANGHAI INTELLECTUAL PROPERTY OFFICE

Unit F, 20th Floor, Neich Tower,

128 Gloucester Road,

HONG KONG

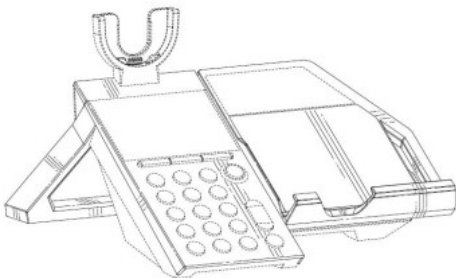

[11] 1913186.9M003

[15] 12-03-2019

- [30] 13-09-2018 / US / 29/663,312
- [51] Cl. 14-03
- [54] 通訊裝置用基座
Base unit for a communications device
- [73] 續特力股份有限公司
PLANTRONICS, INC.
345 Encinal St., Santa Cruz, CA 95060
UNITED STATES
- [74] SHANGHAI INTELLECTUAL PROPERTY OFFICE
Unit F, 20th Floor, Neich Tower,
128 Gloucester Road,
HONG KONG

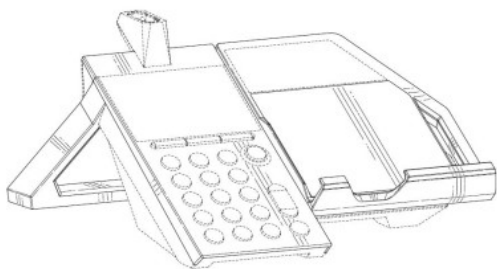

-
- [11] 1913186.9M004
- [15] 12-03-2019
- [30] 13-09-2018 / US / 29/663,312
- [51] Cl. 14-03
- [54] 通訊裝置用基座
Base unit for a communications device
- [73] 續特力股份有限公司
PLANTRONICS, INC.
345 Encinal St., Santa Cruz, CA 95060
UNITED STATES
- [74] SHANGHAI INTELLECTUAL PROPERTY OFFICE
Unit F, 20th Floor, Neich Tower,
128 Gloucester Road,
HONG KONG

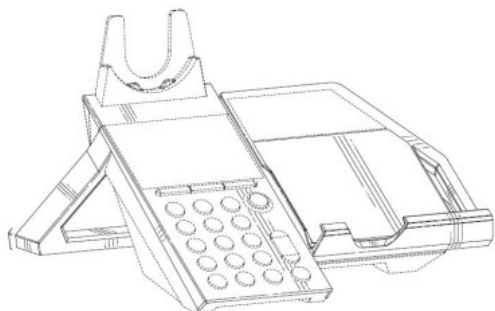

[11] 1913188.3

[15] 13-03-2019

[30] 18-09-2018 / EU / 005647575-0001

[51] Cl. 15-05

[54] 吸塵器組件

Accessories for vacuum cleaners

[73] NEW ERMES EUROPE S.r.l.

Via Risorgimento, 19

21020 CROSIO DELLA VALLE (VA)

ITALY

[74] CLT PATENT & TRADEMARK (H.K.) LIMITED

Unit 09, 34/F., Office Tower, Convention Plaza

No. 1 Harbour Road, Wanchai Hong Kong

HONG KONG



[11] 1913189.5

[15] 13-03-2019

[30] 01-02-2019 / CN / 201930058873.1

[51] Cl. 14-01

[54] 藍牙音箱

Bluetooth Speaker

[73] 深圳市雲動創想科技有限公司

NA

中國內地 廣東省深圳市南山區粵海街道科

技園 科技路 9 號螞蟻邦創業加速中心

616 單元

[74] HK STANDARD INTELLECTUAL PROPERTY LIMITED

香港

中環幹諾道中 64 號

中華廠商會大廈 21 樓

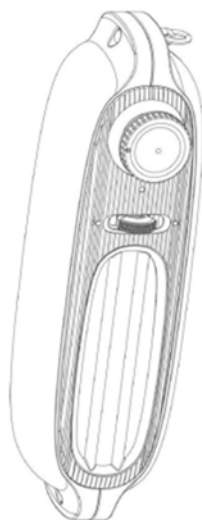

[11] 1913190.7

[15] 13-03-2019

[51] Cl. 7-02

[54] 肉類熟成架

Aging rack for meat

[73] PRIMO AGER LIMITED

FLAT A6, 8/F CHUNG SHUN KNITTING CTR, 1-3 WING YIP ST, KWAI

CHUNG, NT

HONG KONG

[74] CHINAHONGKONG PATENT LIMITED

3012, 30/F, Office Tower, Convention Plaza, 1 Harbour Road

HONG KONG

HONG KONG

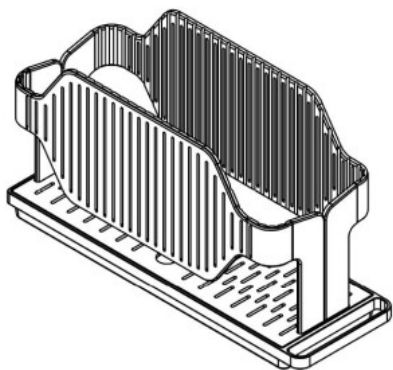

[11] 1913194.5M001

[15] 14-03-2019

[30] 14-09-2018 / EU / 005641032-0001

[51] Cl. 12-08

[54] 車

Car

[73] FERRARI S.p.A.

VIA EMILIA EST 1163

I-41100 MODENA

ITALY

[74] CHINA PATENT AGENT (HONG KONG) LIMITED

22/F, Great Eagle Centre, 23 Harbour Road, Wanchai

HONG KONG

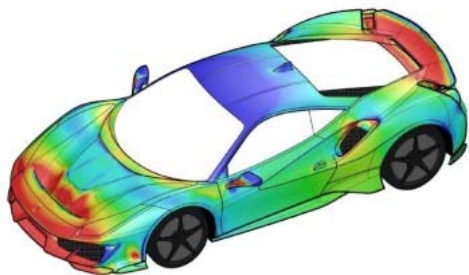

[11] 1913194.5M002

[15] 14-03-2019

[30] 14-09-2018 / EU / 005641032-0001

[51] Cl. 12-08

[54] 車

Car

[73] FERRARI S.p.A.

VIA EMILIA EST 1163

I-41100 MODENA

ITALY

[74] CHINA PATENT AGENT (HONG KONG) LIMITED
22/F, Great Eagle Centre, 23 Harbour Road, Wanchai
HONG KONG

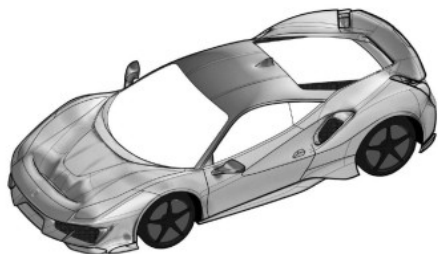

[11] 1913194.5M003

[15] 14-03-2019

[30] 14-09-2018 / EU / 005641032-0001

[51] Cl. 12-08

[54] 車

Car

[73] FERRARI S.p.A.
VIA EMILIA EST 1163
I-41100 MODENA
ITALY

[74] CHINA PATENT AGENT (HONG KONG) LIMITED
22/F, Great Eagle Centre, 23 Harbour Road, Wanchai
HONG KONG



[11] 1913194.5M004

[15] 14-03-2019

[30] 14-09-2018 / EU / 005641032-0001

[51] Cl. 12-08

[54] 車

Car

[73] FERRARI S.p.A.
VIA EMILIA EST 1163
I-41100 MODENA
ITALY

[74] CHINA PATENT AGENT (HONG KONG) LIMITED
22/F, Great Eagle Centre, 23 Harbour Road, Wanchai
HONG KONG

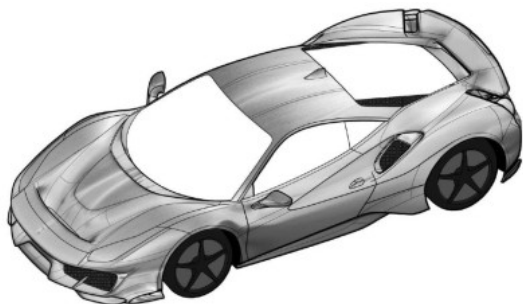

[11] 1913194.5M005

[15] 14-03-2019

[30] 14-09-2018 / EU / 005641032-0001

[51] Cl. 12-08

[54] 車

Car

[73] FERRARI S.p.A.
VIA EMILIA EST 1163
I-41100 MODENA
ITALY

[74] CHINA PATENT AGENT (HONG KONG) LIMITED
22/F, Great Eagle Centre, 23 Harbour Road, Wanchai
HONG KONG

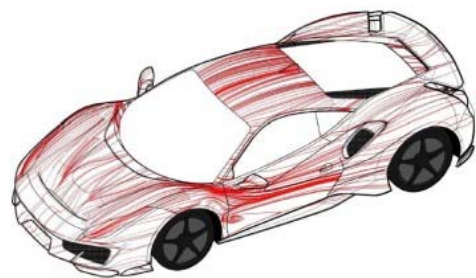

[11] 1913194.5M006

[15] 14-03-2019

[30] 14-09-2018 / EU / 005641032-0001

[51] Cl. 12-08

[54] 車

Car

[73] FERRARI S.p.A.

VIA EMILIA EST 1163

I-41100 MODENA

ITALY

[74] CHINA PATENT AGENT (HONG KONG) LIMITED

22/F, Great Eagle Centre, 23 Harbour Road, Wanchai

HONG KONG

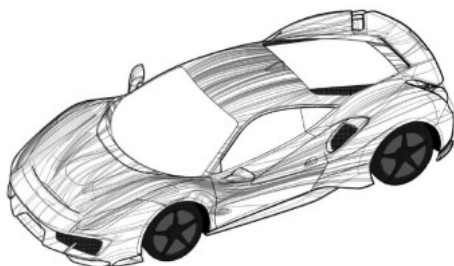

[11] 1913194.5M007

[15] 14-03-2019

[30] 14-09-2018 / EU / 005641032-0001

[51] Cl. 12-08

[54] 車

Car

[73] FERRARI S.p.A.

VIA EMILIA EST 1163

I-41100 MODENA

ITALY

[74] CHINA PATENT AGENT (HONG KONG) LIMITED

22/F, Great Eagle Centre, 23 Harbour Road, Wanchai

HONG KONG



[11] 1913194.5M008

[15] 14-03-2019

[30] 14-09-2018 / EU / 005641032-0001

[51] Cl. 12-08

[54] 車

Car

[73] FERRARI S.p.A.

VIA EMILIA EST 1163

I-41100 MODENA

ITALY

[74] CHINA PATENT AGENT (HONG KONG) LIMITED

22/F, Great Eagle Centre, 23 Harbour Road, Wanchai

HONG KONG

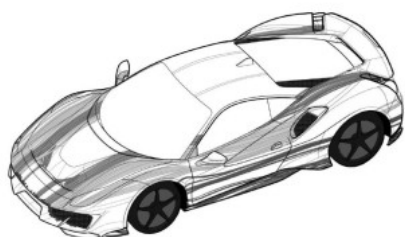

[11] 1913194.5M009

[15] 14-03-2019

[30] 14-09-2018 / EU / 005641032-0001

[51] Cl. 12-08

[54] 車

Car

[73] FERRARI S.p.A.

VIA EMILIA EST 1163

I-41100 MODENA

ITALY

[74] CHINA PATENT AGENT (HONG KONG) LIMITED

22/F, Great Eagle Centre, 23 Harbour Road, Wanchai

HONG KONG

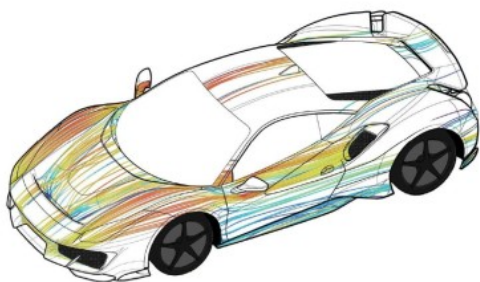

[11] 1913194.5M010

[15] 14-03-2019

[30] 14-09-2018 / EU / 005641032-0001

[51] Cl. 12-08

[54] 車

Car

[73] FERRARI S.p.A.

VIA EMILIA EST 1163

I-41100 MODENA

ITALY

[74] CHINA PATENT AGENT (HONG KONG) LIMITED

22/F, Great Eagle Centre, 23 Harbour Road, Wanchai

HONG KONG

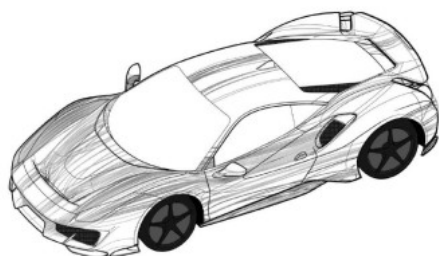

[11] 1913194.5M011

[15] 14-03-2019

[30] 14-09-2018 / EU / 005641032-0001

[51] Cl. 12-08

[54] 車

Car

[73] FERRARI S.p.A.

VIA EMILIA EST 1163

I-41100 MODENA

ITALY

[74] CHINA PATENT AGENT (HONG KONG) LIMITED

22/F, Great Eagle Centre, 23 Harbour Road, Wanchai

HONG KONG

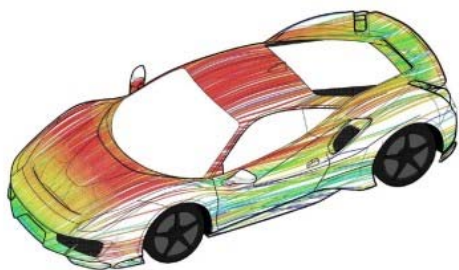

[11] 1913194.5M012

[15] 14-03-2019

[30] 14-09-2018 / EU / 005641032-0001

[51] Cl. 12-08

[54] 車

Car

[73] FERRARI S.p.A.

VIA EMILIA EST 1163

I-41100 MODENA

ITALY

[74] CHINA PATENT AGENT (HONG KONG) LIMITED

22/F, Great Eagle Centre, 23 Harbour Road, Wanchai

HONG KONG

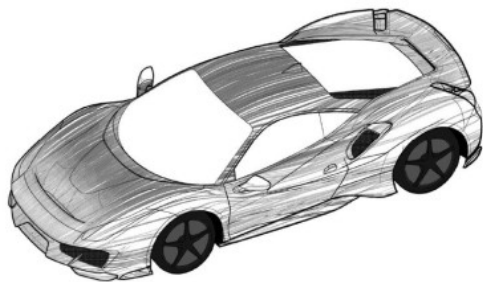

[11] 1913195.8M001

[15] 14-03-2019

[30] 14-09-2018 / EU / 005641305

[51] Cl. 6-04

[54] 車形傢具件

Car-shaped furniture element

[73] FERRARI S.p.A.

VIA EMILIA EST 1163

I-41100 MODENA

ITALY

[74] CHINA PATENT AGENT (HONG KONG) LIMITED
22/F, Great Eagle Centre, 23 Harbour Road, Wanchai
HONG KONG

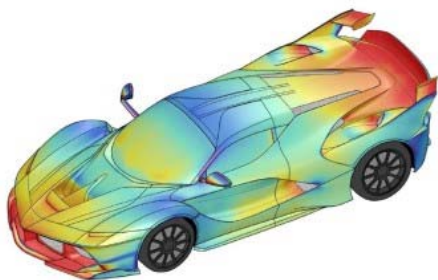

[11] 1913195.8M002

[15] 14-03-2019

[30] 14-09-2018 / EU / 005641305

[51] Cl. 6-04

[54] 車形傢具件
Car-shaped furniture element

[73] FERRARI S.p.A.
VIA EMILIA EST 1163
I-41100 MODENA
ITALY

[74] CHINA PATENT AGENT (HONG KONG) LIMITED
22/F, Great Eagle Centre, 23 Harbour Road, Wanchai
HONG KONG

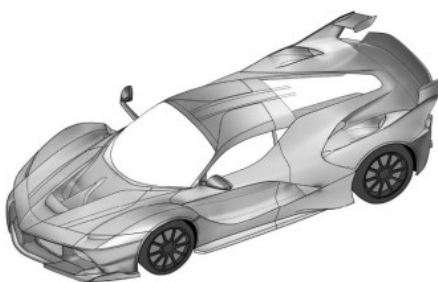

[11] 1913195.8M003

[15] 14-03-2019

[30] 14-09-2018 / EU / 005641305

[51] Cl. 6-04

[54] 車形傢具件
Car-shaped furniture element

[73] FERRARI S.p.A.
VIA EMILIA EST 1163

I-41100 MODENA
ITALY

[74] CHINA PATENT AGENT (HONG KONG) LIMITED
22/F, Great Eagle Centre, 23 Harbour Road, Wanchai
HONG KONG

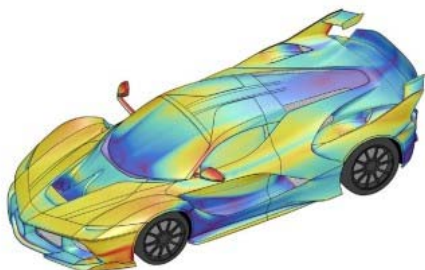

[11] 1913195.8M004

[15] 14-03-2019

[30] 14-09-2018 / EU / 005641305

[51] Cl. 6-04

[54] 車形傢具件

Car-shaped furniture element

[73] FERRARI S.p.A.

VIA EMILIA EST 1163

I-41100 MODENA

ITALY

[74] CHINA PATENT AGENT (HONG KONG) LIMITED
22/F, Great Eagle Centre, 23 Harbour Road, Wanchai
HONG KONG

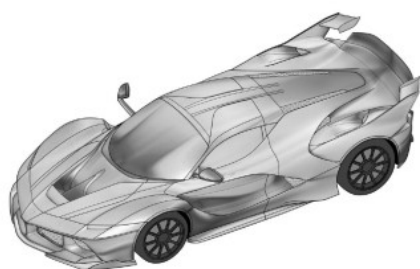

[11] 1913195.8M005

[15] 14-03-2019

[30] 14-09-2018 / EU / 005641305

[51] Cl. 6-04

[54] 車形傢具件
Car-shaped furniture element

[73] FERRARI S.p.A.
VIA EMILIA EST 1163
I-41100 MODENA
ITALY

[74] CHINA PATENT AGENT (HONG KONG) LIMITED
22/F, Great Eagle Centre, 23 Harbour Road, Wanchai
HONG KONG

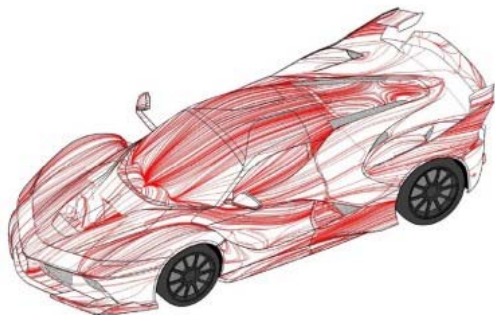

[11] 1913195.8M006

[15] 14-03-2019

[30] 14-09-2018 / EU / 005641305

[51] Cl. 6-04

[54] 車形傢具件
Car-shaped furniture element

[73] FERRARI S.p.A.
VIA EMILIA EST 1163
I-41100 MODENA
ITALY

[74] CHINA PATENT AGENT (HONG KONG) LIMITED
22/F, Great Eagle Centre, 23 Harbour Road, Wanchai
HONG KONG

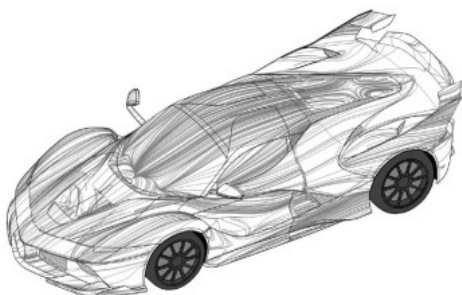

[11] 1913195.8M007

[15] 14-03-2019

[30] 14-09-2018 / EU / 005641305

[51] Cl. 6-04

[54] 車形傢具件

Car-shaped furniture element

[73] FERRARI S.p.A.

VIA EMILIA EST 1163

I-41100 MODENA

ITALY

[74] CHINA PATENT AGENT (HONG KONG) LIMITED

22/F, Great Eagle Centre, 23 Harbour Road, Wanchai

HONG KONG

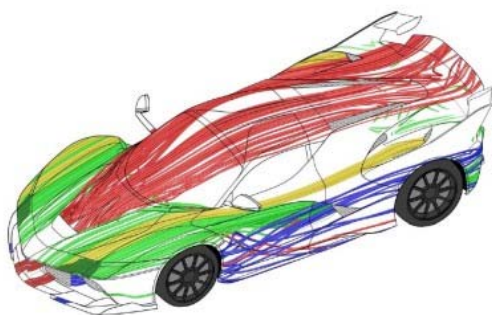

[11] 1913195.8M008

[15] 14-03-2019

[30] 14-09-2018 / EU / 005641305

[51] Cl. 6-04

[54] 車形傢具件

Car-shaped furniture element

[73] FERRARI S.p.A.

VIA EMILIA EST 1163

I-41100 MODENA

ITALY

[74] CHINA PATENT AGENT (HONG KONG) LIMITED

22/F, Great Eagle Centre, 23 Harbour Road, Wanchai

HONG KONG

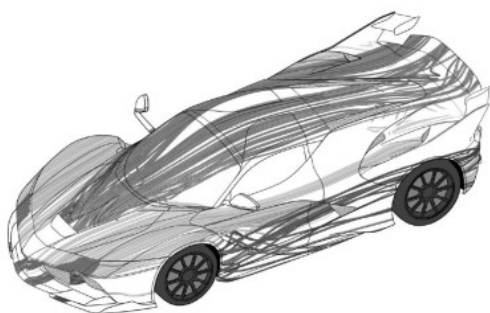

[11] 1913195.8M009

[15] 14-03-2019

[30] 14-09-2018 / EU / 005641305

[51] Cl. 6-04

[54] 車形傢具件

Car-shaped furniture element

[73] FERRARI S.p.A.

VIA EMILIA EST 1163

I-41100 MODENA

ITALY

[74] CHINA PATENT AGENT (HONG KONG) LIMITED

22/F, Great Eagle Centre, 23 Harbour Road, Wanchai

HONG KONG

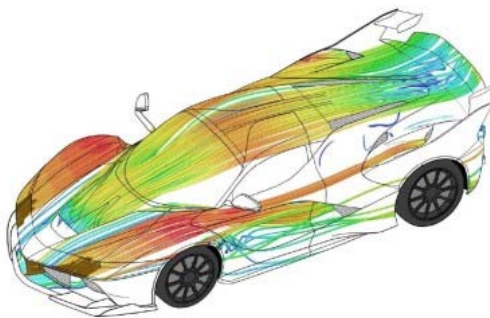

[11] 1913195.8M010

[15] 14-03-2019

[30] 14-09-2018 / EU / 005641305

[51] Cl. 6-04

[54] 車形傢具件

Car-shaped furniture element

[73] FERRARI S.p.A.

VIA EMILIA EST 1163

I-41100 MODENA
ITALY

[74] CHINA PATENT AGENT (HONG KONG) LIMITED
22/F, Great Eagle Centre, 23 Harbour Road, Wanchai
HONG KONG

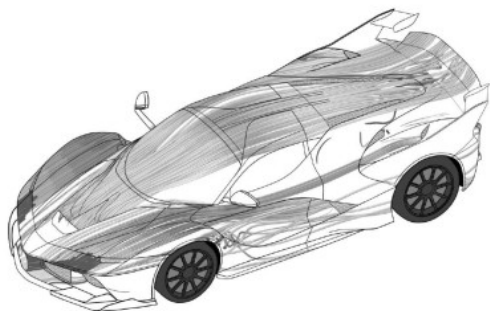

[11] 1913196.0M001

[15] 14-03-2019

[30] 14-09-2018 / EU / 005641040

[51] Cl. 12-08

[54] 車

Car

[73] FERRARI S.p.A.

VIA EMILIA EST 1163 I-41100

MODENA

ITALY

[74] CHINA PATENT AGENT (HONG KONG) LIMITED
22/F, Great Eagle Centre, 23 Harbour Road, Wanchai
HONG KONG

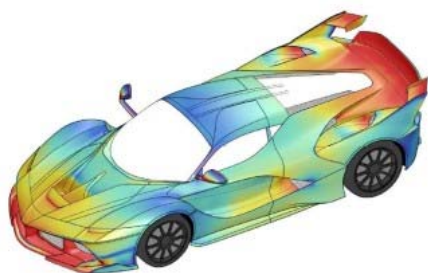

[11] 1913196.0M002

[15] 14-03-2019

[30] 14-09-2018 / EU / 005641040

[51] Cl. 12-08

[54] 車

Car

[73] FERRARI S.p.A.

VIA EMILIA EST 1163 I-41100

MODENA

ITALY

[74] CHINA PATENT AGENT (HONG KONG) LIMITED

22/F, Great Eagle Centre, 23 Harbour Road, Wanchai

HONG KONG

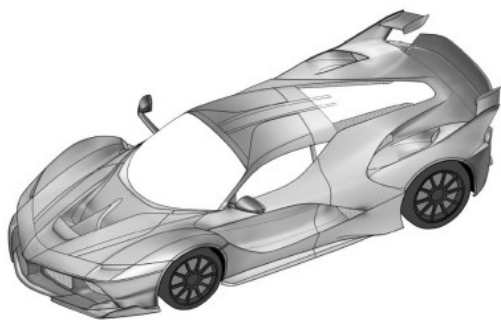

[11] 1913196.0M003

[15] 14-03-2019

[30] 14-09-2018 / EU / 005641040

[51] Cl. 12-08

[54] 車

Car

[73] FERRARI S.p.A.

VIA EMILIA EST 1163 I-41100

MODENA

ITALY

[74] CHINA PATENT AGENT (HONG KONG) LIMITED

22/F, Great Eagle Centre, 23 Harbour Road, Wanchai

HONG KONG



[11] 1913196.0M004

[15] 14-03-2019

[30] 14-09-2018 / EU / 005641040

[51] Cl. 12-08

[54] 車

Car

[73] FERRARI S.p.A.

VIA EMILIA EST 1163 I-41100

MODENA

ITALY

[74] CHINA PATENT AGENT (HONG KONG) LIMITED

22/F, Great Eagle Centre, 23 Harbour Road, Wanchai

HONG KONG

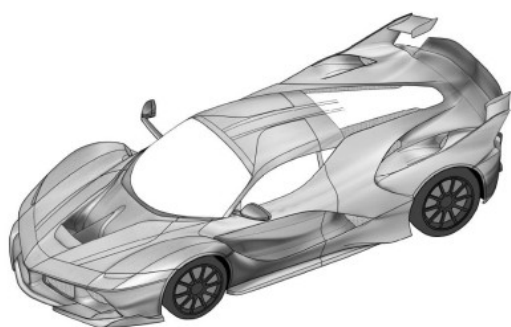

[11] 1913196.0M005

[15] 14-03-2019

[30] 14-09-2018 / EU / 005641040

[51] Cl. 12-08

[54] 車

Car

[73] FERRARI S.p.A.

VIA EMILIA EST 1163 I-41100

MODENA

ITALY

[74] CHINA PATENT AGENT (HONG KONG) LIMITED

22/F, Great Eagle Centre, 23 Harbour Road, Wanchai

HONG KONG

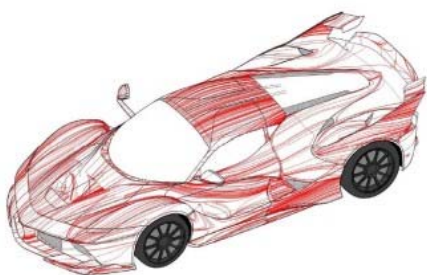

[11] 1913196.0M006

[15] 14-03-2019

[30] 14-09-2018 / EU / 005641040

[51] Cl. 12-08

[54] 車

Car

[73] FERRARI S.p.A.

VIA EMILIA EST 1163 I-41100

MODENA

ITALY

[74] CHINA PATENT AGENT (HONG KONG) LIMITED

22/F, Great Eagle Centre, 23 Harbour Road, Wanchai

HONG KONG

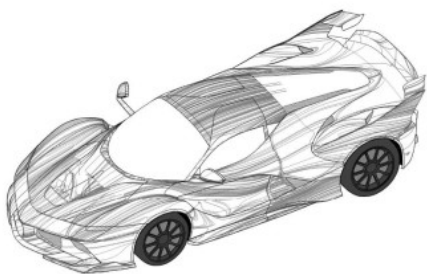

[11] 1913196.0M007

[15] 14-03-2019

[30] 14-09-2018 / EU / 005641040

[51] Cl. 12-08

[54] 車

Car

[73] FERRARI S.p.A.

VIA EMILIA EST 1163 I-41100

MODENA

ITALY

[74] CHINA PATENT AGENT (HONG KONG) LIMITED
22/F, Great Eagle Centre, 23 Harbour Road, Wanchai
HONG KONG

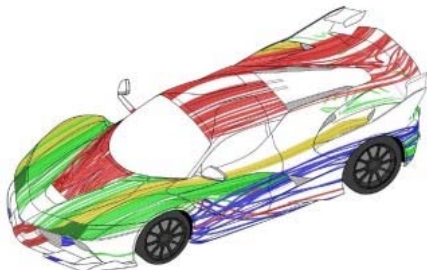

[11] 1913196.0M008

[15] 14-03-2019

[30] 14-09-2018 / EU / 005641040

[51] Cl. 12-08

[54] 車

Car

[73] FERRARI S.p.A.

VIA EMILIA EST 1163 I-41100

MODENA

ITALY

[74] CHINA PATENT AGENT (HONG KONG) LIMITED
22/F, Great Eagle Centre, 23 Harbour Road, Wanchai
HONG KONG

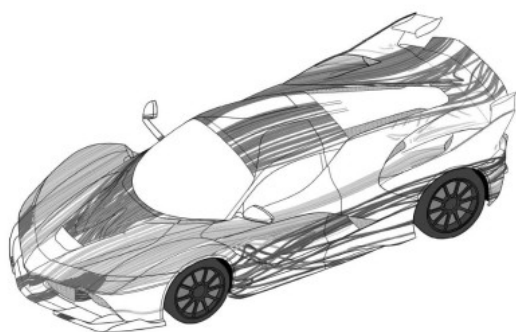

[11] 1913196.0M009

[15] 14-03-2019

[30] 14-09-2018 / EU / 005641040

[51] Cl. 12-08

[54] 車

Car

[73] FERRARI S.p.A.

VIA EMILIA EST 1163 I-41100

MODENA

ITALY

[74] CHINA PATENT AGENT (HONG KONG) LIMITED

22/F, Great Eagle Centre, 23 Harbour Road, Wanchai

HONG KONG

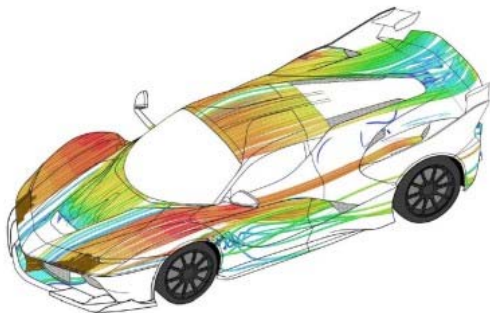

[11] 1913196.0M010

[15] 14-03-2019

[30] 14-09-2018 / EU / 005641040

[51] Cl. 12-08

[54] 車

Car

[73] FERRARI S.p.A.

VIA EMILIA EST 1163 I-41100

MODENA

ITALY

[74] CHINA PATENT AGENT (HONG KONG) LIMITED

22/F, Great Eagle Centre, 23 Harbour Road, Wanchai

HONG KONG

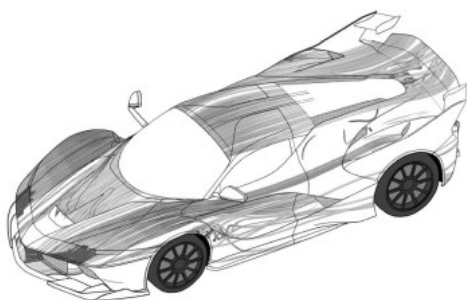

[11] 1913197.2M001

[15] 14-03-2019

[30] 14-09-2018 / EU / 005640901

[51] Cl. 6-04

[54] 車形傢俱件

Car-shaped furniture element

[73] FERRARI S.p.A.

VIA EMILIA EST 1163 I-41100

MODENA

ITALY

[74] CHINA PATENT AGENT (HONG KONG) LIMITED

22/F, Great Eagle Centre, 23 Harbour Road, Wanchai

HONG KONG

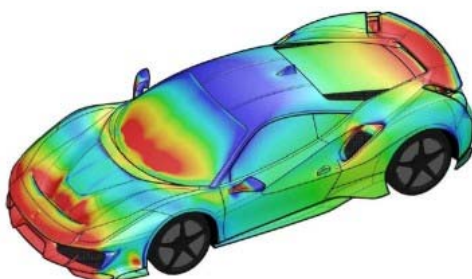

[11] 1913197.2M002

[15] 14-03-2019

[30] 14-09-2018 / EU / 005640901

[51] Cl. 6-04

[54] 車形傢俱件

Car-shaped furniture element

[73] FERRARI S.p.A.

VIA EMILIA EST 1163 I-41100

MODENA

ITALY

[74] CHINA PATENT AGENT (HONG KONG) LIMITED

22/F, Great Eagle Centre, 23 Harbour Road, Wanchai

HONG KONG

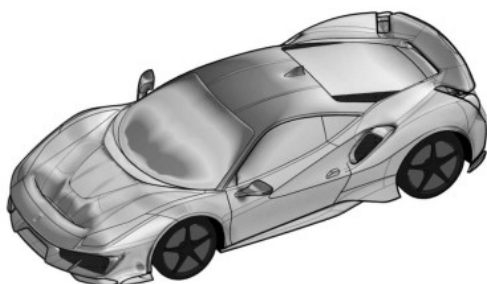

[11] 1913197.2M003

[15] 14-03-2019

[30] 14-09-2018 / EU / 005640901

[51] Cl. 6-04

[54] 車形傢俱件

Car-shaped furniture element

[73] FERRARI S.p.A.

VIA EMILIA EST 1163 I-41100

MODENA

ITALY

[74] CHINA PATENT AGENT (HONG KONG) LIMITED

22/F, Great Eagle Centre, 23 Harbour Road, Wanchai

HONG KONG

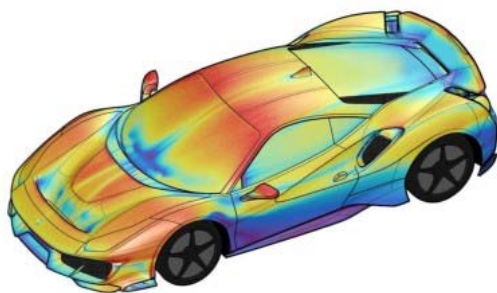

[11] 1913197.2M004

[15] 14-03-2019

[30] 14-09-2018 / EU / 005640901

[51] Cl. 6-04

[54] 車形傢俱件

Car-shaped furniture element

[73] FERRARI S.p.A.

VIA EMILIA EST 1163 I-41100

MODENA

ITALY

[74] CHINA PATENT AGENT (HONG KONG) LIMITED

22/F, Great Eagle Centre, 23 Harbour Road, Wanchai

HONG KONG

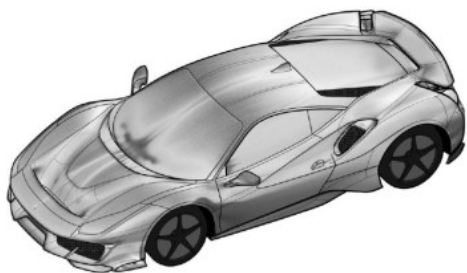

[11] 1913197.2M005

[15] 14-03-2019

[30] 14-09-2018 / EU / 005640901

[51] Cl. 6-04

[54] 車形傢俱件

Car-shaped furniture element

[73] FERRARI S.p.A.

VIA EMILIA EST 1163 I-41100

MODENA

ITALY

[74] CHINA PATENT AGENT (HONG KONG) LIMITED

22/F, Great Eagle Centre, 23 Harbour Road, Wanchai

HONG KONG

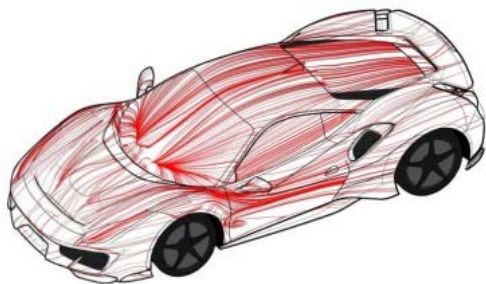

[11] 1913197.2M006

[15] 14-03-2019

[30] 14-09-2018 / EU / 005640901

[51] Cl. 6-04

[54] 車形傢俱件

Car-shaped furniture element

[73] FERRARI S.p.A.

VIA EMILIA EST 1163 I-41100

MODENA

ITALY

[74] CHINA PATENT AGENT (HONG KONG) LIMITED
22/F, Great Eagle Centre, 23 Harbour Road, Wanchai
HONG KONG

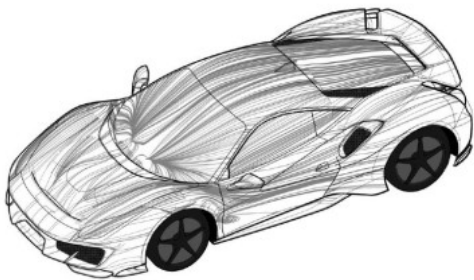

[11] 1913197.2M007

[15] 14-03-2019

[30] 14-09-2018 / EU / 005640901

[51] Cl. 6-04

[54] 車形傢俱件

Car-shaped furniture element

[73] FERRARI S.p.A.

VIA EMILIA EST 1163 I-41100

MODENA

ITALY

[74] CHINA PATENT AGENT (HONG KONG) LIMITED
22/F, Great Eagle Centre, 23 Harbour Road, Wanchai
HONG KONG

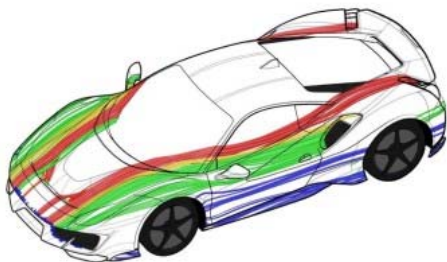

[11] 1913197.2M008

[15] 14-03-2019

[30] 14-09-2018 / EU / 005640901

[51] Cl. 6-04

[54] 車形傢俱件

Car-shaped furniture element

[73] FERRARI S.p.A.

VIA EMILIA EST 1163 I-41100

MODENA

ITALY

[74] CHINA PATENT AGENT (HONG KONG) LIMITED
22/F, Great Eagle Centre, 23 Harbour Road, Wanchai
HONG KONG

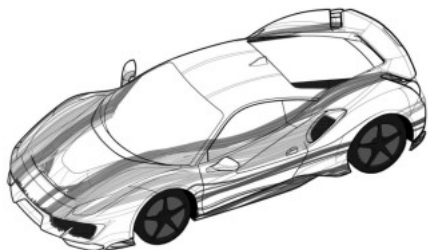

[11] 1913197.2M009

[15] 14-03-2019

[30] 14-09-2018 / EU / 005640901

[51] Cl. 6-04

[54] 車形傢俱件

Car-shaped furniture element

[73] FERRARI S.p.A.

VIA EMILIA EST 1163 I-41100

MODENA

ITALY

[74] CHINA PATENT AGENT (HONG KONG) LIMITED
22/F, Great Eagle Centre, 23 Harbour Road, Wanchai
HONG KONG

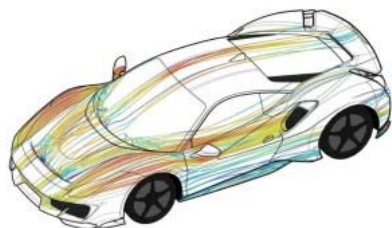

[11] 1913197.2M010

[15] 14-03-2019

[30] 14-09-2018 / EU / 005640901

[51] Cl. 6-04

[54] 車形傢俱件

Car-shaped furniture element

[73] FERRARI S.p.A.

VIA EMILIA EST 1163 I-41100

MODENA

ITALY

[74] CHINA PATENT AGENT (HONG KONG) LIMITED
22/F, Great Eagle Centre, 23 Harbour Road, Wanchai
HONG KONG

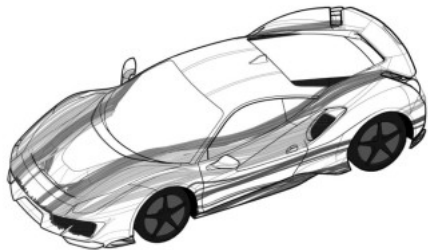

[11] 1913197.2M011

[15] 14-03-2019

[30] 14-09-2018 / EU / 005640901

[51] Cl. 6-04

[54] 車形傢俱件

Car-shaped furniture element

[73] FERRARI S.p.A.

VIA EMILIA EST 1163 I-41100

MODENA

ITALY

[74] CHINA PATENT AGENT (HONG KONG) LIMITED
22/F, Great Eagle Centre, 23 Harbour Road, Wanchai
HONG KONG

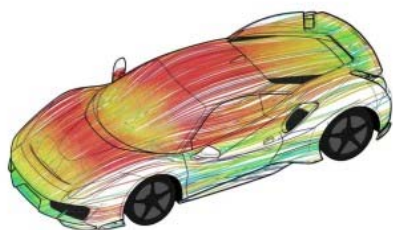

[11] 1913197.2M012

[15] 14-03-2019

[30] 14-09-2018 / EU / 005640901

[51] Cl. 6-04

[54] 車形傢俱件

Car-shaped furniture element

[73] FERRARI S.p.A.
VIA EMILIA EST 1163 I-41100
MODENA
ITALY

[74] CHINA PATENT AGENT (HONG KONG) LIMITED
22/F, Great Eagle Centre, 23 Harbour Road, Wanchai
HONG KONG

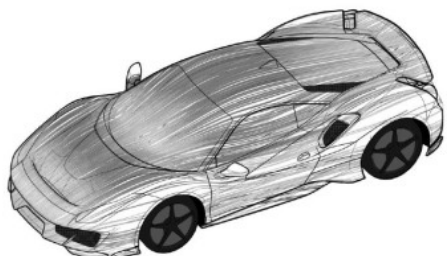

[11] 1913197.2M013

[15] 14-03-2019

[30] 14-09-2018 / EU / 005640901

[51] Cl. 6-04

[54] 車形傢俱件
Car-shaped furniture element

[73] FERRARI S.p.A.
VIA EMILIA EST 1163 I-41100
MODENA
ITALY

[74] CHINA PATENT AGENT (HONG KONG) LIMITED
22/F, Great Eagle Centre, 23 Harbour Road, Wanchai
HONG KONG



[11] 1913197.2M014

[15] 14-03-2019

[30] 14-09-2018 / EU / 005640901

[51] Cl. 6-04

[54] 車形傢俱件
Car-shaped furniture element

[73] FERRARI S.p.A.
VIA EMILIA EST 1163 I-41100
MODENA
ITALY

[74] CHINA PATENT AGENT (HONG KONG) LIMITED
22/F, Great Eagle Centre, 23 Harbour Road, Wanchai
HONG KONG



[11] 1913197.2M015

[15] 14-03-2019

[30] 14-09-2018 / EU / 005640901

[51] Cl. 6-04

[54] 車形傢俱件
Car-shaped furniture element

[73] FERRARI S.p.A.
VIA EMILIA EST 1163 I-41100
MODENA
ITALY

[74] CHINA PATENT AGENT (HONG KONG) LIMITED
22/F, Great Eagle Centre, 23 Harbour Road, Wanchai
HONG KONG



[11] 1913198.4

- [15] 14-03-2019
- [30] 24-01-2019 / CN / 201930040181.4
- [51] Cl. 26-04
- [54] 紅外線激光測距 LED 燈
LED lamp with the function of infrared laser ranging
- [73] 上海智匯電器有限公司
AEC Lighting Solutions Co., Ltd
中國內地 上海市
嘉定區
馬陸鎮寶安公路 2548 號,
郵編 201801
- [74] 中港專利有限公司
港灣道 1 號會展廣場辦公大樓 30 樓 3012 室
HONG KONG
HONG KONG



-
- [11] 1913199.6M001
- [15] 14-03-2019
- [30] 19-09-2018 / US / 29/663,896
- [51] Cl. 14-03
- [54] 通訊頭戴式送受話器
Communications headset
- [73] 繽特力股份有限公司
PLANTRONICS, INC.
345 Encinal Street, P.O. Box 635, Santa Cruz, CA 95060
UNITED STATES
- [74] SHANGHAI INTELLECTUAL PROPERTY OFFICE
Unit F, 20th Floor, Neich Tower,
128 Gloucester Road,
HONG KONG



[11] 1913199.6M002

[15] 14-03-2019

[30] 19-09-2018 / US / 29/663,896

[51] Cl. 14-03

[54] 通訊頭戴式送受話器

Communications Headset

[73] 繽特力股份有限公司

PLANTRONICS, INC.

345 Encinal Street, P.O. Box 635, Santa Cruz, CA 95060

UNITED STATES

[74] SHANGHAI INTELLECTUAL PROPERTY OFFICE

Unit F, 20th Floor, Neich Tower,

128 Gloucester Road,

HONG KONG



[11] 1913202.4M001

[15] 15-03-2019

[51] Cl. 2-02

[54] 襯衫

Shirt

[73] YAMATO HOLDINGS CO., LTD.

2-16-10 Ginza

Chuo-ku Tokyo

JAPAN

[74] DEACONS

5th Floor, Alexandra House

Central

HONG KONG



[11] 1913202.4M002

[15] 15-03-2019

[51] Cl. 2-02

[54] 襯衫

Shirt

[73] YAMATO HOLDINGS CO., LTD.

2-16-10 Ginza

Chuo-ku Tokyo

JAPAN

[74] DEACONS

5th Floor, Alexandra House

Central

HONG KONG



[11] 1913202.4M003

[15] 15-03-2019

[51] Cl. 2-02

[54] 夾克

Jacket

[73] YAMATO HOLDINGS CO., LTD.

2-16-10 Ginza

Chuo-ku Tokyo

JAPAN

[74] DEACONS

5th Floor, Alexandra House

Central

HONG KONG



[11] 1913204.8

[15] 15-03-2019

[51] Cl. 23-04

[54] 香薰機

Aroma diffuser

[73] 璞真生活有限公司

Puzhen Life Co., Limited

Unit 1112-1116, 11/F, Delta House,

3 On Yiu Street, Shatin

HONG KONG

[74] FEDERATION OF HONG KONG INDUSTRIES

31/F, Billion Plaza,

8 Cheung Yue Street, Cheung Sha Wan, Kowloon

HONG KONG

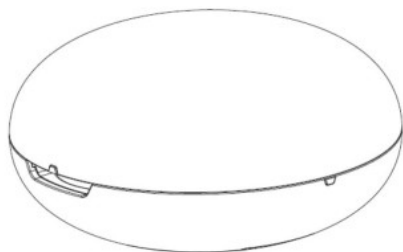

[11] 1913205.1M001

[15] 15-03-2019

[30] 18-09-2018 / EU / 005646007

[51] Cl. 15-05

[54] 吸塵機

Vacuum cleaner

[73] Koninklijke Philips N.V.

High Tech Campus 5,

5656 AE, Eindhoven,

NETHERLANDS

[74] WILKINSON & GRIST

6th Floor, Prince's Building

Chater Road

HONG KONG



[11] 1913205.1M002

[15] 15-03-2019

[30] 18-09-2018 / EU / 005646007

[51] Cl. 15-05

[54] 吸塵機的手提部件

Handheld part of vacuum cleaner

[73] Koninklijke Philips N.V.

High Tech Campus 5,

5656 AE, Eindhoven,

NETHERLANDS

[74] WILKINSON & GRIST

6th Floor, Prince's Building

Chater Road

HONG KONG



[11] 1913206.3

[15] 15-03-2019

[30] 18-09-2018 / EU / 005646510-0001

[51] Cl. 15-05

[54] 真空吸塵器的吸嘴

Nozzle for vacuum cleaner

[73] Koninklijke Philips N.V.

High Tech Campus 5,

5656 AE, Eindhoven,

NETHERLANDS

[74] WILKINSON & GRIST

6th Floor, Prince's Building

Chater Road

HONG KONG

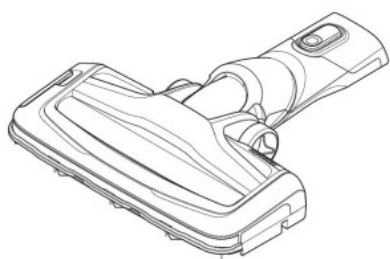

[11] 1913207.5

[15] 15-03-2019

[30] 17-09-2018 / US / 29/663,611

[51] Cl. 19-08

[54] 帶標籤的交易卡

Transaction card with label

[73] 蘋果公司

APPLE INC.

ONE APPLE PARK WAY, CUPERTINO, CALIFORNIA 95014

UNITED STATES

[74] CLT PATENT & TRADEMARK (H.K.) LIMITED

Unit 09, 34/F., Office Tower, Convention Plaza

No. 1 Harbour Road, Wanchai

HONG KONG

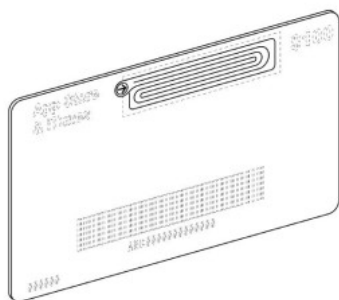

[11] 1913213.7

[15] 15-03-2019

[30] 19-10-2018 / JP / 2018 of 023046

[51] Cl. 28-03

[54] 按摩機

Massage machine

[73] 發美利稻田株式會社

FAMILY INADA CO., LTD.

日本 大阪府大阪市澱川

區 西宮原二丁目 1 番 3

號

[74] 中港專利有限公司

港灣道 1 號會展廣場辦公大樓 30 樓 3012 室

HONG KONG

HONG KONG

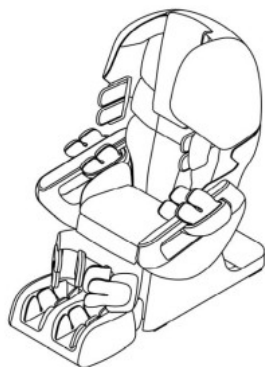

[11] 1913215.2M001

[15] 15-03-2019

[30] 21-09-2018 / EU, MC, KR, SG, CH, UA, TR / DM/103 165

[51] Cl. 3-01

[54] 手袋

Handbag

[73] Bottega Veneta SA

Via Industria 19, Cadempino, 6814,
SWITZERLAND

[74] REBECCA LO & CO

1408 Dina House, Ruttonjee Centre
11 Duddell Street, Central
HONG KONG



[11] 1913215.2M002

[15] 15-03-2019

[30] 21-09-2018 / EU, MC, KR, SG, CH, UA, TR / DM/103 165

[51] Cl. 3-01

[54] 手袋

Handbag

[73] Bottega Veneta SA

Via Industria 19, Cadempino, 6814,
SWITZERLAND

[74] REBECCA LO & CO

1408 Dina House, Ruttonjee Centre
11 Duddell Street, Central
HONG KONG



[11] 1913215.2M003

[15] 15-03-2019

[30] 21-09-2018 / EU, MC, KR, SG, CH, UA, TR / DM/103 165

[51] Cl. 3-01

[54] 手袋

Handbag

[73] Bottega Veneta SA

Via Industria 19, Cadempino, 6814,
SWITZERLAND

[74] REBECCA LO & CO

1408 Dina House, Ruttonjee Centre
11 Duddell Street, Central
HONG KONG



[11] 1913215.2M004

[15] 15-03-2019

[30] 21-09-2018 / EU, MC, KR, SG, CH, UA, TR / DM/103 165

[51] Cl. 3-01

[54] 手袋

Handbag

[73] Bottega Veneta SA

Via Industria 19, Cadempino, 6814,
SWITZERLAND

[74] REBECCA LO & CO

1408 Dina House, Ruttonjee Centre
11 Duddell Street, Central
HONG KONG



[11] 1913216.4

[15] 15-03-2019

[30] 21-09-2018 / EU, MC, KR, SG, CH, UA, TR / DM/103164

[51] Cl. 2-04

[54] 運動鞋

Sneaker

[73] Bottega Veneta SA

Via Industria 19, Cadempino, 6814,

SWITZERLAND

[74] REBECCA LO & CO

1408 Dina House, Ruttonjee Centre

11 Duddell Street, Central

HONG KONG



[11] 1913217.6

[15] 15-03-2019

[30] 18-09-2018 / EU / 005646528

[51] Cl. 15-05

[54] 真空吸塵器的吸嘴

Nozzle for vacuum cleaner

[73] Koninklijke Philips N.V.

High Tech Campus 5,

5656 AE, Eindhoven

NETHERLANDS

[74] WILKINSON & GRIST

6th Floor, Prince's Building

Chater Road

HONG KONG

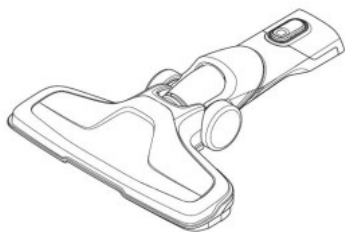

[11] 1913218.8

[15] 15-03-2019

[30] 23-01-2019 / CN / 201930037525.6

[51] Cl. 6-01

[54] 休閒按摩椅

Leisure massage chair

[73] 廈門愛瑪康科技有限公司

中國內地

廈門市同安工業集中區思明工

業園 112 號三樓

[74] 香港專利商標代理有限公司

香港

皇后大道西 419K

博仕臺 10 樓 A 室



[11] 1913219.0M001

[15] 15-03-2019

[30] 17-01-2019 / CN / 201930026586.2

[51] Cl. 6-01

[54] 休閒按摩椅

Leisure massage chair

[73] 廈門愛瑪康科技有限公司
中國內地
廈門市同安工業 集中區思明工
業園 112 號三樓

[74] 香港專利商標代理有限公司
香港
皇后大道西 419K
博仕臺 10 樓 A 室



[11] 1913219.0M002

[15] 15-03-2019

[30] 17-01-2019 / CN / 201930026586.2

[51] Cl. 6-01

[54] 休閒按摩椅

Leisure massage chair

[73] 廈門愛瑪康科技有限公司
中國內地
廈門市同安工業 集中區思明工
業園 112 號三樓

[74] 香港專利商標代理有限公司
香港
皇后大道西 419K
博仕臺 10 樓 A 室



[11] 1913220.2M001

[15] 15-03-2019

[51] Cl. 14-02

[54] 筆記本電腦

Laptop computer

[73] 愛高電業有限公司

Alco Electronics Limited

11/F., Metropole Square

2 On Yiu Street, Sha Tin, New Territories

HONG KONG

[74] MARKS & CLERK

Level 9, Cyberport 1

100 Cyberport Road, Pok Fu Lam

HONG KONG

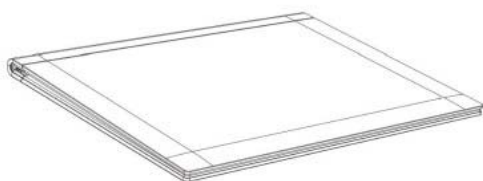

[11] 1913220.2M002

[15] 15-03-2019

[51] Cl. 14-02

[54] 筆記本電腦

Laptop computer

[73] 愛高電業有限公司

Alco Electronics Limited

11/F., Metropole Square

2 On Yiu Street, Sha Tin, New Territories
HONG KONG

[74] MARKS & CLERK
Level 9, Cyberport 1
100 Cyberport Road, Pok Fu Lam
HONG KONG



[11] 1913222.6
[15] 18-03-2019
[30] 19-09-2018 / KR / 30-2018-0044011
[51] Cl. 13-02
[54] 電子煙充電器
Charger for electronic cigarette

[73] KT&G Corporation
71, Beotkkot-gil,
Daedeok-gu, Daejeon
KOREA, REPUBLIC OF

[74] Luo & Jia Intellectual Property Limited
9B, Cheong Tai Commercial Building,
66 Wing Lok Street, Sheung Wan,
HONG KONG

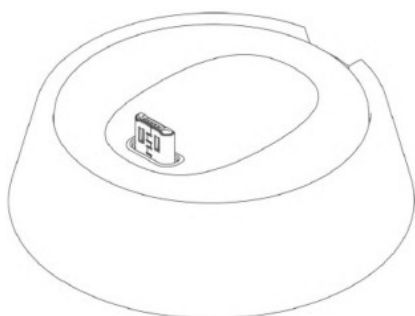

[11] 1913223.8
[15] 18-03-2019
[30] 18-09-2018 / KR / 30-2018-0043848
[51] Cl. 27-99

[54] 電子煙芯體
Cartridge for electronic cigarette

[73] KT&G Corporation
71, Beotkkot-gil,
Daedeok-gu, Daejeon
KOREA, REPUBLIC OF

[74] Luo & Jia Intellectual Property Limited
9B, Cheong Tai Commercial Building,
66 Wing Lok Street, Sheung Wan,
HONG KONG

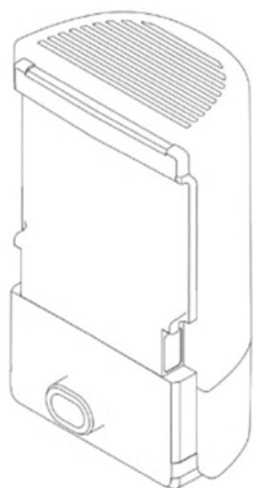

[11] 1913224.0

[15] 18-03-2019

[30] 19-09-2018 / KR / 30-2018-0044012

[51] Cl. 13-02

[54] 電子煙充電器
Charger for electronic cigarette

[73] KT&G Corporation
71, Beotkkot-gil,
Daedeok-gu, Daejeon
KOREA, REPUBLIC OF

[74] Luo & Jia Intellectual Property Limited
9B, Cheong Tai Commercial Building,
66 Wing Lok Street, Sheung Wan,
HONG KONG

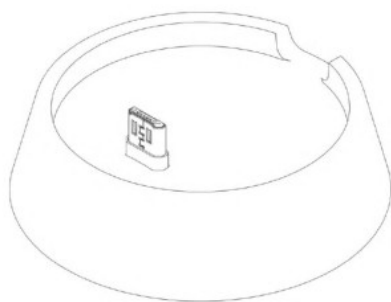

[11] 1913225.3

[15] 18-03-2019

[30] 19-09-2018 / KR / 30-2018-0044013

[51] Cl. 13-02

[54] 電子煙充電器

Charger for electronic cigarette

[73] KT&G Corporation

71, Beotkkot-gil,

Daedeok-gu, Daejeon

KOREA, REPUBLIC OF

[74] Luo & Jia Intellectual Property Limited

9B, Cheong Tai Commercial Building,

66 Wing Lok Street, Sheung Wan,

HONG KONG

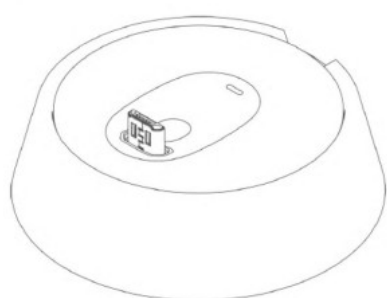

[11] 1913227.7

[15] 18-03-2019

[51] Cl. 3-99

[54] 掛鎖行李標籤

Padlock tag

[73] Robert Adamberry
7A, 7/F, Hing Wai Centre
7 Tin Wan Praya Road Aberdeen, Hong Kong

[74] Robert Adamberry
7A, 7/F, Hing Wai Centre
7 Tin Wan Praya Road Aberdeen, Hong Kong

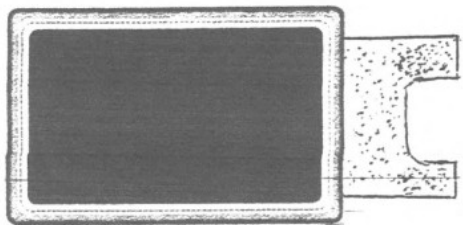

[11] 1913229.1

[15] 18-03-2019

[30] 01-02-2019 / CN / 201930059246.X

[51] Cl. 14-03

[54] 手機

Mobile phone

[73] 維沃移動通信有限公司

VIVO MOBILE COMMUNICATION CO., LTD.

中國內地 廣東省東莞市長

安鎮 烏沙步步高大道 283

號

[74] 中國專利代理(香港)有限公司

香港

灣仔港灣道 23 號

鷹君中心 22 字樓



[11] 1913232.7

[15] 18-03-2019

[51] Cl. 7-99

[54] 用於泵瓶的錐形插入件

Conical Shape Insert for Pump Bottles

[73] William B. Wu

P.O. Box 65486

Port Ludlow, WA 98365

UNITED STATES

[74] HNC INNOVATION LIMITED

Units 1205-1208, Cyberport 2, No. 100

Cyberport Road

HONG KONG

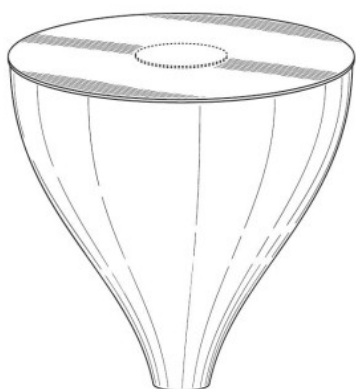

[11] 1913235.4

[15] 18-03-2019

[30] 22-10-2018 / US / 29/667,451

[51] Cl. 2-04

[54] 鞋

SHOE

[73] 街頭趨勢有限公司

StreetTrend LLC

100 E. Sandreed Rd. Jackson, WY 83001

UNITED STATES

[74] CHINAHONGKONG IP LIMITED

3011, 30/F, Office Tower, Convention Plaza, 1 Harbour Road

HONG KONG

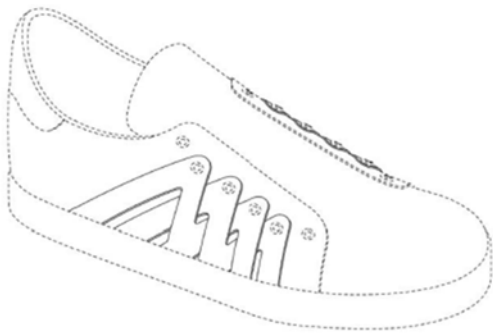

[11] 1913244.2

[15] 19-03-2019

[30] 28-09-2018 / JP / 2018 of 021159

[51] Cl. 13-02

[54] 電動車充電器

Battery charger for electric vehicles

[73] 松下知識產權經營株式會社

Panasonic Intellectual Property Management Co., Ltd.

1-61, Shiromi 2-chome, Chuo-ku,

Osaka-shi, Osaka 540-6207

JAPAN

[74] MARKS & CLERK

Level 9, Cyberport 1

100 Cyberport Road, Pok Fu Lam

HONG KONG

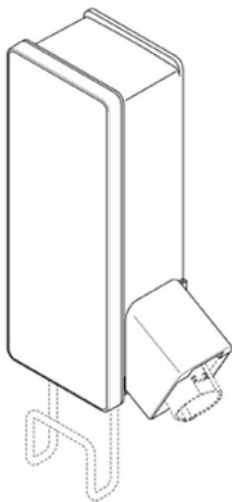

- [11] 1913246.7
[15] 19-03-2019
[30] 14-01-2019 / US / 29/676,694
[51] Cl. 28-03
[54] 皮膚護理器
Skin treatment device
[73] Telebrands Corp.
79 Two Bridges Road, Fairfield, New Jersey 07004,
UNITED STATES
[74] SPRUSON & FERGUSON (HONG KONG) LIMITED
5001 Hopewell Centre
183 Queen's Road East, Wan Chai
HONG KONG

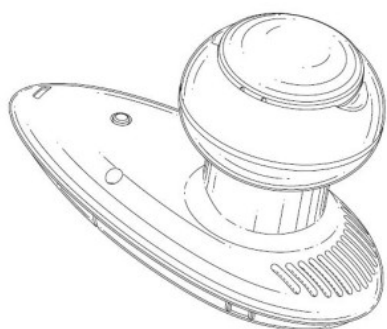

-
- [11] 1913249.3
[15] 20-03-2019
[30] 25-09-2018 / JP / 2018 of 020758
[51] Cl. 2-99
[54] 手關節用支撐套
Wrist joint supporter
[73] 興和株式會社
KOWA COMPANY, LTD.
日本 愛知縣名古屋
市
中區錦三丁目 6 番 29 號

飯田靴下株式會社
IIDA HOSIERY CO., LTD.
日本 奈良
縣
禦所市 138 番地

- [74] 中國專利代理(香港)有限公司
香港
灣仔港灣道 23 號
鷹君中心 22 字樓

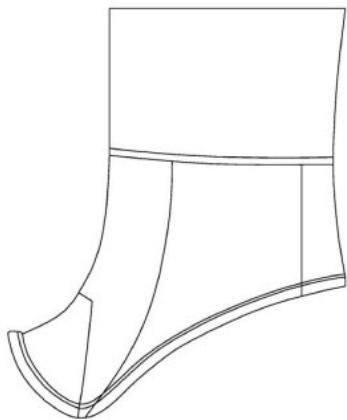

- [11] 1913250.5
[15] 20-03-2019
[30] 20-09-2018 / JP / 2018 of 020459
[51] Cl. 23-01
[54] 水質變更機
Water quality change device
[73] 麥克賽爾控股株式會社
Maxell Holdings, Ltd.
日本 日本國京都府乙
訓郡
大山崎町大山崎小泉1 番地
[74] 中國專利代理(香港)有限公司
香港
灣仔港灣道 23 號
鷹君中心 22 字樓

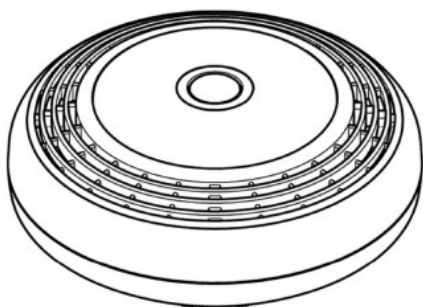

[11] 1913251.7

[15] 20-03-2019

[30] 20-09-2018 / EU / 005650835

[51] Cl. 3-01

[54] 袋

Bag

[73] Fendi S.r.l.

Palazzo della Civiltà Italiana

Quadrato della Concordia 3

00144 Roma

ITALY

[74] BAKER & MCKENZIE

14th Floor, One Taikoo Place

979 King's Road, Quarry Bay

HONG KONG



[11] 1913252.9M001

[15] 20-03-2019

[30] 21-09-2018 / CN / 201830534372.1

[51] Cl. 15-09

[54] 模具鑲嵌塊

Die insert

[73] 深圳裕盈科技有限公司

中國內地 廣東省深圳

市龍崗區 橫崗街道大

康社區龍村

寶龍路 30-8 號 101 之二, 201

- [74] 德龍知識產權集團(香港)有限公司
香港
灣仔軒尼詩道 338 號 北海
中心 10 樓 E 室

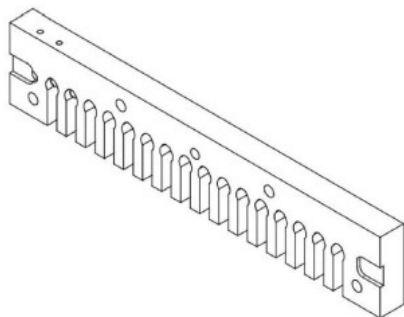

-
- [11] 1913252.9M002
[15] 20-03-2019
[30] 21-09-2018 / CN / 201830534372.1
[51] Cl. 15-09
[54] 模具鑲嵌塊
Die insert
[73] 深圳裕盈科技有限公司
中國內地 廣東省深圳
市龍崗區 橫崗街道大
康社區龍村
寶龍路 30-8 號 101 之二, 201
[74] 德龍知識產權集團(香港)有限公司
香港
灣仔軒尼詩道 338 號 北海
中心 10 樓 E 室

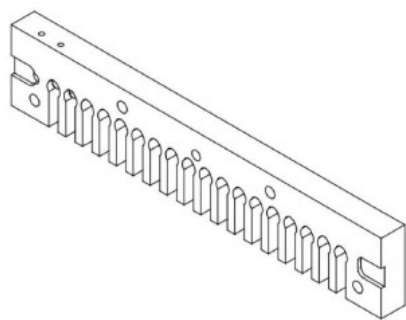

[11] 1913252.9M003

[15] 20-03-2019

[30] 21-09-2018 / CN / 201830534372.1

[51] Cl. 15-09

[54] 模具鑲嵌塊
Die insert

[73] 深圳裕盈科技有限公司
中國內地 廣東省深圳
市龍崗區 橫崗街道大
康社區龍村
寶龍路 30-8 號 101 之二, 201

[74] 德龍知識產權集團(香港)有限公司
香港
灣仔軒尼詩道 338 號 北海
中心 10 樓 E 室

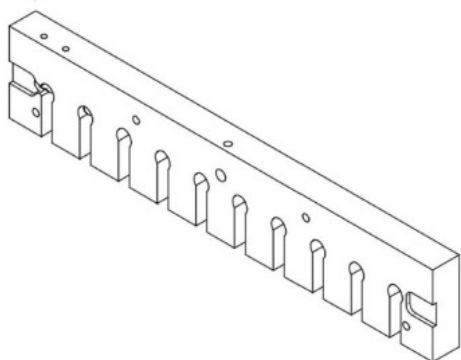



香港特別行政區政府知識產權署外觀設計註冊處

The Government of the Hong Kong Special Administrative Region

Designs Registry, Intellectual Property Department

根據註冊外觀設計條例第28條，下列註冊外觀設計因未繳續期費而停止有效。各組記項按註冊外觀設計停止有效日期及註冊編號先後次序排列。

Registered designs ceased through non-payment of renewal fees under section 28 of the Registered Designs Ordinance. Entries are listed below under their expiry dates.

29-07-2019 - 07-08-2019

29-07-2019	0901229.5M001	0901252.3M006
0411687.3M001	0901229.5M002	0901252.3M007
		0901252.3M008

02-08-2019	03-08-2019	0901252.3M009
0411720.4M001	0411739.4	1401429.6M001
0411720.4M002	0901232.1M001	1401429.6M002
0411724.2	0901232.1M002	1401429.6M003
0411726.7M001	0901232.1M003	1401430.8M001
0411726.7M002	0901232.1M004	1401430.8M002
0411726.7M003	0901232.1M005	1401430.8M003
0411726.7M004	0901233.3M001	1401430.8M004
0411726.7M005	0901233.3M002	1401431.0
0411726.7M006	0901233.3M003	1401433.4M001
0411726.7M007	0901236.0	1401433.4M002
0411726.7M008	0901237.2	1401433.4M003
0411726.7M009	0901238.4	1401433.4M004
0411727.9M001	0901239.6	1401434.6
0411727.9M002	0901240.8	9911008.8
0411727.9M003	0901241.0	

0411727.9M004	1401298.7	05-08-2019
0411727.9M005	1401299.9	0411748.3M001
0411727.9M006	1401427.2	0411748.3M002
0411727.9M007	1401428.4M001	0411755.8
0411727.9M008	1401428.4M002	0901253.5
0411727.9M009		0901254.7
0411728.1M001	04-08-2019	0901257.4M005
0411728.1M002	0411745.7	1401441.1M001
0411728.1M003	0901244.6	1401441.1M002
0411728.1M004	0901245.9	1401441.1M003

0411728.1M005	0901252.3M001	
0411728.1M006	0901252.3M002	06-08-2019
0411728.1M007	0901252.3M003	0901260.0M001
0411728.1M008	0901252.3M004	0901260.0M002
0411728.1M009	0901252.3M005	0901260.0M003

0901260.0M004
0901260.0M005
0901260.0M006
0901261.2
0901262.4
1401443.5
1401444.7M001
1401444.7M002
1401447.4M001
1401447.4M002
1401447.4M003
1401447.4M004
1401448.6
1401449.8M001
1401449.8M002
1401449.8M003
1401454.8M001
1401454.8M002

07-08-2019

1401457.5
1401458.7M001
1401458.7M002
1401460.1
1401462.5M001
1401462.5M002
1401462.5M003
1401462.5M004
1401462.5M005
1401462.5M006
1401462.5M007
1401462.5M008
1401462.5M009
1401462.5M010
1401462.5M011
1401462.5M012
1401463.7M001
1401463.7M002
1401463.7M003
1401463.7M004
1401463.7M005
1401464.9



香港特別行政區政府知識產權署外觀設計註冊處

The Government of the Hong Kong Special Administrative Region

Designs Registry, Intellectual Property Department

根據註冊外觀設計規則第 31 條刪除的註冊外觀設計。各組記項按註冊外觀設計 刪除日期及註冊編號先後次序排列。

Registered designs removed under section 31 of the Registered Designs Rules. Entries are listed below under their removal dates.

09-08-2019 - 14-08-2019**09-08-2019**

	1400201.2M013
0410226.5M001	1400201.2M016
0410226.5M002	1400201.2M017
0410226.5M003	1400201.2M018
0410227.7M001	1400201.2M019
0410227.7M002	1400203.6M001
0410227.7M003	1400203.6M002
0410231.5M001	9910174.7M001
0900163.3M001	9910174.7M002
0900163.3M002	
0900163.3M003	
0900163.3M004	
0900165.8	

13-08-2019**10-08-2019**

	0410265.7M001
	0410265.7M002
	0900187.4M001
	0900187.4M002
0900169.6	0900189.8
0900171.0	1400207.5M001
0900172.2	1400207.5M002

11-08-2019

	1400207.5M003
	1400207.5M004
0900177.3	1400207.5M005
	1400207.5M006

12-08-2019

	1400207.5M007
0410251.7	1400207.5M008
0410252.9	1400207.5M009
0900183.5M001	1400207.5M010
0900183.5M002	9910177.4
1400200.0	9910178.6
1400201.2M004	9910179.8

14-08-2019

	1400212.5
1400201.2M005	
1400201.2M007	
1400201.2M009	
1400201.2M010	
1400201.2M012	