

香港知識產權公報

Hong Kong Intellectual Property Journal

2020年9月30日
30 September 2020

目錄 Contents

根據註冊外觀設計條例第 25 條註冊的外觀設計

Designs Registered under section 25 of the Registered Designs Ordinance

按註冊編號排列

Arranged by Registration Number

根據註冊外觀設計條例(第 522 章)公布的其他公告

Other Notices Published under the Registered Designs Ordinance (Cap. 522)

根據註冊外觀設計條例第 28 條，註冊外觀設計因未繳續期費而停止有效

Registered designs ceased through non-payment of renewal fees under section 28 of the Registered Designs Ordinance

根據註冊外觀設計規則第 31 條刪除的註冊外觀設計

Registered designs removed under section 31 of the Registered Designs Rules

勘誤

Corrigendum

以下事項沒有記錄

No Records for the Following Matters

根據註冊外觀設計條例第 30 條放棄的外觀設計的註冊

Surrender of Registration of Design under section 30 of the Registered Designs Ordinance

根據註冊外觀設計規則第 37 條，向處長作出轉介

Reference to Registrar under section 37 of the Registered Designs Rules

根據註冊外觀設計條例第 45 條，撤銷註冊

Revocation of Registration under section 45 of the Registered Designs Ordinance

根據註冊外觀設計規則第 46 條，向法院作出轉介

Reference to Court under section 46 of the Registered Designs Rules

根據註冊外觀設計規則第 63 條對不符合規定之處作出糾正

Rectification of Irregularities under section 63 of the Registered Designs Rules

根據註冊外觀設計條例第 66 條，糾正註冊紀錄冊

Rectification of Register under section 66 of the Registered Designs Ordinance

根據註冊外觀設計條例第 67 條 更正註冊紀錄冊內的錯誤

Correction of errors in Register under section 67 of the Registered Designs Ordinance

根據註冊外觀設計條例第 67 及 76 條，更正註冊紀錄冊內及已提交文件中的錯誤

Correction of Errors in Register and in Filed Documents under sections 67 and 76 of the Registered Designs Ordinance

根據註冊外觀設計條例第 76 條，更正已提交文件中的錯誤

Correction of errors in filed documents under section 76 of the Registered Designs Ordinance

註冊外觀設計公告註釋

Notes on advertisements of registration of designs

方括號表示下列資料：

Square brackets indicate the following data：

[11] 註冊編號 Registration number / 聯合王國註冊編號 United Kingdom registration number

[15] 註冊日期 Registration date / 當作註冊日期 Deemed registration date / 聯合王國註冊日期 United Kingdom registration date

[17] 註冊有效期屆滿日期 Expiry date of the period of registration

[22] 提交日期 Filing date / 當作提交日期 Deemed filing date / 聯合王國提交日期 United Kingdom filing date

[30] 聲稱享有的優先權（提交日期 / 巴黎公約國或世界貿易組織成員 / 申請編號） Priority claimed (filing date / Paris Convention country or WTO member / application number)

[51] 國際外觀設計分類號（洛迦諾分類號） International Classification of designs (Locarno Classification)

[54] 物品 Article

[55] 外觀設計的表述 Representation of the design

[62] 分開前的申請編號及提交日期 Application number before division and filing date

[66] 過往註冊的聯繫外觀設計註冊編號 / 日期 Registration No. / Date of Previous Registration for Association

[72] 設計人 Designer

[73] 擁有人姓名和地址 Name and address of the owner

[74] 代理人 Agent / 送達地址 Address for service



香港特別行政區政府知識產權署外觀設計註冊處

The Government of the Hong Kong Special Administrative Region

Designs Registry, Intellectual Property Department

根據註冊外觀設計條例第 25 條註冊的外觀設計

Designs registered under section 25 of the Registered Designs Ordinance

按註冊編號排列

Arranged by Registration Number

[11] 1914672.1

[15] 17-09-2019

[30] 11-04-2019 / CN / 201930162871.7

11-04-2019 / CN / 201930162871.7

[51] Cl. 28-03

[54] 美容儀器

Cosmetic apparatus

[73] 深圳市瑞吉斯科技有限公司

中國內地

深圳市龍華區大浪街道

浪口社區浪口工業園 93 號 1 層

[74] 德龍知識產權集團(香港)有限公司

香港

灣仔軒尼詩道 338 號

北海中心 10 樓 E 室



- [11] 1915074.3
[15] 25-11-2019
[30] 24-10-2019 / JP / 023620 of 2019
[51] Cl. 25-02
[54] 預製或預裝建築部件的下部帶支架皮帶輪
Lower pulley with bracket for prefabricated or pre-assembled parts
[73] YOKOBIKI SR Co., Ltd
2-5-28-808, Shibamata
Katsushika-ku, Tokyo, 125-0052
JAPAN

Shintaro ICHIKAWA
2-5-28-808, Shibamata
Katsushika-ku, Tokyo, 125-0052
JAPAN
[74] VIVIEN CHAN & CO
32/F, Harbour Centre,
25 Harbour Road, Wanchai,
HONG KONG

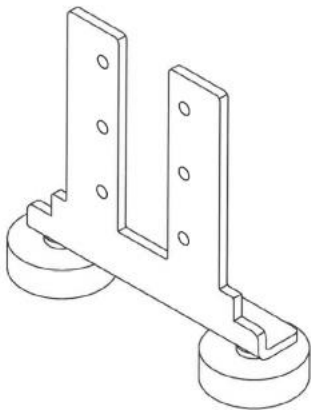

-
- [11] 2015428.8
[15] 16-01-2020
[51] Cl. 3-01
[54] 豬仔錢罌外形收納包
Piggy bank shaped pouch
[73] MORITO SCOVILL HK CO LTD.
香港九龍觀塘
海濱道 143 號
中國航天科技中心 3 樓
[74] MORITO SCOVILL HK CO LTD.
香港九龍觀塘

海濱道 143 號
中國航天科技中心 3 樓



-
- [11] 2015698.0
[15] 05-03-2020
[30] 05-09-2019 / US / 29/704,609
[51] Cl. 28-03
[54] 髮刷盒
Hair brush cartridge
[73] Curallux LLC
1715 NW 82nd Avenue,
Miami, Florida 33126,
UNITED STATES
[74] VIVIEN CHAN & CO
32/F, Harbour Centre,
25 Harbour Road,
Wanchai, Hong Kong

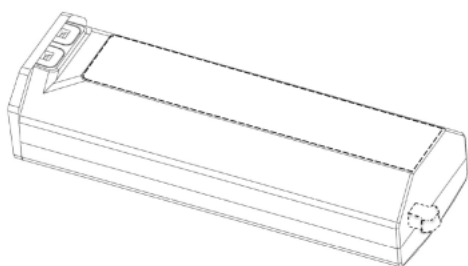

-
- [11] 2015810.9
[15] 19-03-2020
[51] Cl. 23-04

- [54] 空氣淨化器
Air purifier
- [73] 德新國際（香港）有限公司
Dickson International (HK) Ltd.
香港新界
荃灣沙咀道 57 號
荃運工業中心 2 座 8 樓 H 室
- [74] Dickson International (HK) Ltd
香港新界
荃灣沙咀道 57 號
荃運工業中心 2 座 8 樓 H 室



-
- [11] 2015832.5
- [15] 23-03-2020
- [51] Cl. 9-06
- [54] 急凍蘇格蘭三文魚包裝帶
Packaging strip of frozen Scotland salmon fillet
- [73] Onric Development Company Ltd.
香港
香港仔田灣海旁道 7 號
興偉工業中心 6 樓 613B 室
- [74] Onric Development Company Ltd.
香港
香港仔田灣海旁道 7 號
興偉工業中心 6 樓 613B 室



[11] 2015912.5M001

[15] 03-04-2020

[30] 11-10-2019 / EU / 007009303-0001

[51] Cl. 2-04

[54] 鞋

Shoe

[73] Birkenstock Sales GmbH

Rheinstraße 10,

53560 Vettelschoss,

GERMANY

[74] DEACONS

5th Floor, Alexandra House,

Central,

Hong Kong



[11] 2015912.5M002

[15] 03-04-2020

[30] 11-10-2019 / EU / 007009303-0005

[51] Cl. 2-04

[54] 鞋

Shoe

[73] Birkenstock Sales GmbH

Rheinstraße 10,

53560 Vettelschoss,

GERMANY

[74] DEACONS

5th Floor, Alexandra House,

Central,

Hong Kong



[11] 2015912.5M003

[15] 03-04-2020

[30] 11-10-2019 / EU / 007009303-0006

[51] Cl. 2-04

[54] 鞋

Shoe

[73] Birkenstock Sales GmbH

Rheinstraße 10,

53560 Vettelschoss,

GERMANY

[74] DEACONS

5th Floor, Alexandra House,

Central,

Hong Kong



[11] 2015912.5M004

[15] 03-04-2020

[30] 11-10-2019 / EU / 007009303-0011

[51] Cl. 2-04

[54] 鞋

Shoe

[73] Birkenstock Sales GmbH

Rheinstraße 10,

53560 Vettelschoss,

GERMANY

[74] DEACONS

5th Floor, Alexandra House,

Central,

Hong Kong



[11] 2015912.5M005

[15] 03-04-2020

[30] 11-10-2019 / EU / 007009303-0012

[51] Cl. 2-04

[54] 鞋

Shoe

[73] Birkenstock Sales GmbH

Rheinstraße 10,

53560 Vettelschoss,

GERMANY

[74] DEACONS

5th Floor, Alexandra House,

Central,

Hong Kong



[11] 2015912.5M006

[15] 03-04-2020

[30] 11-10-2019 / EU / 007009303-0013

[51] Cl. 2-04

[54] 鞋
Shoe

[73] Birkenstock Sales GmbH
Rheinstraße 10,
53560 Vettelschoss,
GERMANY

[74] DEACONS
5th Floor, Alexandra House,
Central,
Hong Kong



[11] 2015921.4

[15] 06-04-2020

[30] 15-10-2019 / US / 29/709,520

[51] Cl. 2-02

[54] 衣服
Gown

[73] Medicom Group Inc.
2555 Chemin de l'Aviation, Pointe-Claire,
QC H9P 2Z2,
CANADA

[74] ROBERTSONS
57th Floor, The Center,
99 Queen's Road Central,
Hong Kong



[11] 2015955.6

[15] 09-04-2020

[51] Cl. 7-01

[54] 矽膠便攜伸縮杯

Silicone portable collapsible mug

[73] 誠信廣拓有限公司

Lexington Marketing Limited

Unit 5, G/F., Hing Hon Building,

26-36 King's Road,

Tin Hau, Hong Kong

[74] Lexington Marketing Limited

Unit 5, G/F., Hing Hon Building,

26-36 King's Road,

Tin Hau, Hong Kong

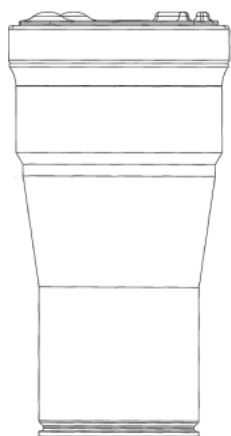

- [11] 2015975.8
[15] 15-04-2020
[51] Cl. 10-04
[54] 數字萬用錶
Digital multimeter
[73] 龍程實業（香港）有限公司
RANGE ENTERPRISE (HONG KONG) CO., LTD
香港北角
英皇道 250 號
北角城中心 8 樓 10 室
[74] RANGE ENTERPRISE (HONG KONG) CO., LTD
香港北角
英皇道 250 號
北角城中心 8 樓 10 室

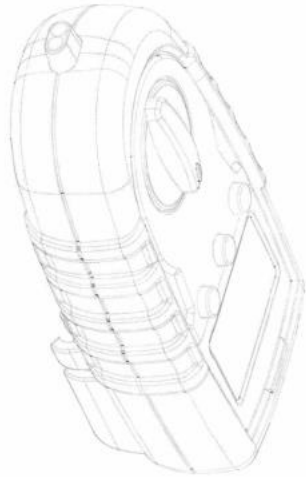

-
- [11] 2015991.1
[15] 16-04-2020
[30] 07-04-2020 / KR / 30-2020-0015475
[51] Cl. 9-01
[54] 化粧品容器
Cosmetic container
[73] COREANA COSMETICS CO., LTD.
6, Samgok2-gil, Seonggeo-eup, Cheonan-si,
Chungcheongnam-do,
KOREA, REPUBLIC OF
[74] LETTERS & THOO LIMITED
Suite 1008, Prosperity Millennia Plaza,
663 King's Road,
Quarry Bay, Hong Kong



[11] 2015993.5

[15] 16-04-2020

[30] 07-04-2020 / KR / 30-2020-0015476

[51] Cl. 9-01

[54] 化粧品容器

Cosmetic container

[73] COREANA COSMETICS CO., LTD.

6, Samgok2-gil, Seonggeo-eup, Cheonan-si,
Chungcheongnam-do,
KOREA, REPUBLIC OF

[74] LETTERS & THOO LIMITED

Suite 1008, Prosperity Millennia Plaza,
663 King's Road,
Quarry Bay, Hong Kong



- [11] 2016034.3M001
[15] 22-04-2020
[30] 29-10-2019 / CN / 201930591959.0
[51] Cl. 14-04
[54] 用於錶面的圖形用戶界面
Graphical user interface used for watch face
[73] 北京小米移動軟件有限公司
BEIJING XIAOMI MOBILE SOFTWARE CO., LTD.
No. 018, Floor 8, Building 6,
Yard 33, Middle Xierqi Road,
Haidian District, Beijing 100085,
China
[74] ACCOLADE IP LIMITED
10/F, Fu Fai Comm. Ctr.,
27 Hillier Street,
Sheung Wan, Hong Kong



-
- [11] 2016034.3M002
[15] 22-04-2020
[30] 29-10-2019 / CN / 201930591959.0
[51] Cl. 14-04
[54] 用於錶面的圖形用戶界面
Graphical user interface used for watch face
[73] 北京小米移動軟件有限公司
BEIJING XIAOMI MOBILE SOFTWARE CO., LTD.
No. 018, Floor 8, Building 6,
Yard 33, Middle Xierqi Road,
Haidian District, Beijing 100085,
China
[74] ACCOLADE IP LIMITED
10/F, Fu Fai Comm. Ctr.,

27 Hillier Street,
Sheung Wan, Hong Kong



[11] 2016034.3M003

[15] 22-04-2020

[30] 29-10-2019 / CN / 201930591959.0

[51] Cl. 14-04

[54] 用於錶面的圖形用戶界面

Graphical user interface used for watch face

[73] 北京小米移動軟件有限公司

BEIJING XIAOMI MOBILE SOFTWARE CO., LTD.

No. 018, Floor 8, Building 6,

Yard 33, Middle Xierqi Road,

Haidian District, Beijing 100085,

China

[74] ACCOLADE IP LIMITED

10/F, Fu Fai Comm. Ctr.,

27 Hillier Street,

Sheung Wan, Hong Kong



[11] 2016034.3M004

[15] 22-04-2020

- [30] 29-10-2019 / CN / 201930591959.0
- [51] Cl. 14-04
- [54] 用於錶面的圖形用戶界面
Graphical user interface used for watch face
- [73] 北京小米移動軟件有限公司
BEIJING XIAOMI MOBILE SOFTWARE CO., LTD.
No. 018, Floor 8, Building 6,
Yard 33, Middle Xierqi Road,
Haidian District, Beijing 100085,
China
- [74] ACCOLADE IP LIMITED
10/F, Fu Fai Comm. Ctr.,
27 Hillier Street,
Sheung Wan, Hong Kong

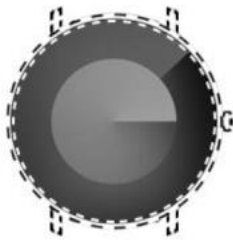

-
- [11] 2016035.6M001
- [15] 22-04-2020
- [30] 29-10-2019 / CN / 201930591958.6
- [51] Cl. 14-04
- [54] 用於錶面的圖形用戶界面
Graphical user interface used for watch face
- [73] 北京小米移動軟件有限公司
BEIJING XIAOMI MOBILE SOFTWARE CO., LTD.
No.018, Floor 8, Building 6,
Yard 33, Middle Xierqi Road,
Haidian District, Beijing 100085,
China
- [74] ACCOLADE IP LIMITED
10/F, Fu Fai Comm. Ctr.,
27 Hillier Street,
Sheung Wan, Hong Kong



[11] 2016035.6M002

[15] 22-04-2020

[30] 29-10-2019 / CN / 201930591958.6

[51] Cl. 14-04

[54] 用於錶面的圖形用戶界面

Graphical user interface used for watch face

[73] 北京小米移動軟件有限公司

BEIJING XIAOMI MOBILE SOFTWARE CO., LTD.

No.018, Floor 8, Building 6,

Yard 33, Middle Xierqi Road,

Haidian District, Beijing 100085,

China

[74] ACCOLADE IP LIMITED

10/F, Fu Fai Comm. Ctr.,

27 Hillier Street,

Sheung Wan, Hong Kong



[11] 2016035.6M003

[15] 22-04-2020

[30] 29-10-2019 / CN / 201930591958.6

- [51] Cl. 14-04
- [54] 用於錶面的圖形用戶界面
Graphical user interface used for watch face
- [73] 北京小米移動軟件有限公司
BEIJING XIAOMI MOBILE SOFTWARE CO., LTD.
No.018, Floor 8, Building 6,
Yard 33, Middle Xierqi Road,
Haidian District, Beijing 100085,
China
- [74] ACCOLADE IP LIMITED
10/F, Fu Fai Comm. Ctr.,
27 Hillier Street,
Sheung Wan, Hong Kong



-
- [11] 2016035.6M004
- [15] 22-04-2020
- [30] 29-10-2019 / CN / 201930591958.6
- [51] Cl. 14-04
- [54] 用於錶面的圖形用戶界面
Graphical user interface used for watch face
- [73] 北京小米移動軟件有限公司
BEIJING XIAOMI MOBILE SOFTWARE CO., LTD.
No.018, Floor 8, Building 6,
Yard 33, Middle Xierqi Road,
Haidian District, Beijing 100085,
China
- [74] ACCOLADE IP LIMITED
10/F, Fu Fai Comm. Ctr.,
27 Hillier Street,
Sheung Wan, Hong Kong



-
- [11] 2016035.6M005
[15] 22-04-2020
[30] 29-10-2019 / CN / 201930591958.6
[51] Cl. 14-04
[54] 用於錶面的圖形用戶界面
Graphical user interface used for watch face
[73] 北京小米移動軟件有限公司
BEIJING XIAOMI MOBILE SOFTWARE CO., LTD.
No.018, Floor 8, Building 6,
Yard 33, Middle Xierqi Road,
Haidian District, Beijing 100085,
China
[74] ACCOLADE IP LIMITED
10/F, Fu Fai Comm. Ctr.,
27 Hillier Street,
Sheung Wan, Hong Kong



-
- [11] 2016035.6M006
[15] 22-04-2020
[30] 29-10-2019 / CN / 201930591958.6
[51] Cl. 14-04
[54] 用於錶面的圖形用戶界面
Graphical user interface used for watch face

[73] 北京小米移動軟件有限公司
BEIJING XIAOMI MOBILE SOFTWARE CO., LTD.
No.018, Floor 8, Building 6,
Yard 33, Middle Xierqi Road,
Haidian District, Beijing 100085,
China

[74] ACCOLADE IP LIMITED
10/F, Fu Fai Comm. Ctr.,
27 Hillier Street,
Sheung Wan, Hong Kong



[11] 2016035.6M007

[15] 22-04-2020

[30] 29-10-2019 / CN / 201930591958.6

[51] Cl. 14-04

[54] 用於錶面的圖形用戶界面
Graphical user interface used for watch face

[73] 北京小米移動軟件有限公司
BEIJING XIAOMI MOBILE SOFTWARE CO., LTD.
No.018, Floor 8, Building 6,
Yard 33, Middle Xierqi Road,
Haidian District, Beijing 100085,
China

[74] ACCOLADE IP LIMITED
10/F, Fu Fai Comm. Ctr.,
27 Hillier Street,
Sheung Wan, Hong Kong



[11] 2016035.6M008

[15] 22-04-2020

[30] 29-10-2019 / CN / 201930591958.6

[51] Cl. 14-04

[54] 用於錶面的圖形用戶界面

Graphical user interface used for watch face

[73] 北京小米移動軟件有限公司

BEIJING XIAOMI MOBILE SOFTWARE CO., LTD.

No.018, Floor 8, Building 6,

Yard 33, Middle Xierqi Road,

Haidian District, Beijing 100085,

China

[74] ACCOLADE IP LIMITED

10/F, Fu Fai Comm. Ctr.,

27 Hillier Street,

Sheung Wan, Hong Kong



[11] 2016035.6M009

[15] 22-04-2020

[30] 29-10-2019 / CN / 201930591958.6

[51] Cl. 14-04

[54] 用於錶面的圖形用戶界面
Graphical user interface used for watch face

[73] 北京小米移動軟件有限公司
BEIJING XIAOMI MOBILE SOFTWARE CO., LTD.
No.018, Floor 8, Building 6,
Yard 33, Middle Xierqi Road,
Haidian District, Beijing 100085,
China

[74] ACCOLADE IP LIMITED
10/F, Fu Fai Comm. Ctr.,
27 Hillier Street,
Sheung Wan, Hong Kong



[11] 2016035.6M010

[15] 22-04-2020

[30] 29-10-2019 / CN / 201930591958.6

[51] Cl. 14-04

[54] 用於錶面的圖形用戶界面
Graphical user interface used for watch face

[73] 北京小米移動軟件有限公司
BEIJING XIAOMI MOBILE SOFTWARE CO., LTD.
No.018, Floor 8, Building 6,
Yard 33, Middle Xierqi Road,
Haidian District, Beijing 100085,
China

[74] ACCOLADE IP LIMITED
10/F, Fu Fai Comm. Ctr.,
27 Hillier Street,
Sheung Wan, Hong Kong



[11] 2016184.0

[15] 21-05-2020

[51] Cl. 26-05

[54] 摺紙檯燈
Paper table lamp

[73] 梁偉雄
LEUNG WAI HUNG
香港香港仔奇力灣
嘉隆苑嘉平閣 706 室

[74] 梁偉雄
香港香港仔奇力灣
嘉隆苑嘉平閣 706 室

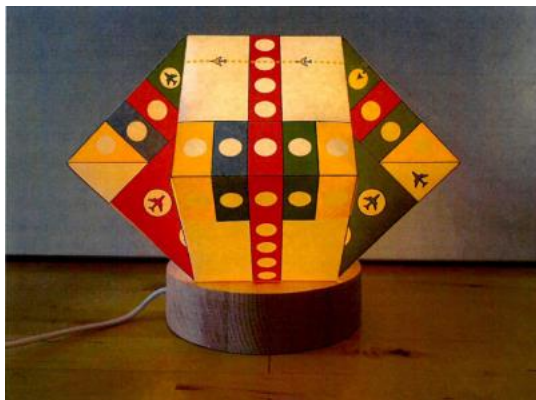

[11] 2016406.3M001

[15] 24-06-2020

[51] Cl. 21-01

[54] 積木
Building block

[73] 佳樂專有限公司
Kalos Blocks Company Limited

9/F., Southeast Industrial Building,
611-619 Castle Peak Road,
Tsuen Wan, Hong Kong

- [74] HONG KONG INTELLECTUAL PROPERTY ADVISORY SERVICE LIMITED
Unit 1701, 17/F., Ew International Tower,
120 Texaco Road,
Tsuen Wan, New Territories,
Hong Kong

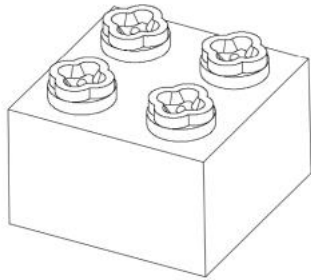

[11] 2016406.3M002

[15] 24-06-2020

[51] Cl. 21-01

[54] 積木

Building box

[73] 佳樂專有限公司

Kalos Blocks Company Limited

9/F., Southeast Industrial Building,

611-619 Castle Peak Road,

Tsuen Wan, Hong Kong

[74] HONG KONG INTELLECTUAL PROPERTY ADVISORY SERVICE LIMITED

Unit 1701, 17/F., Ew International Tower,

120 Texaco Road,

Tsuen Wan, New Territories,

Hong Kong

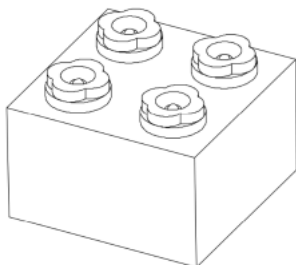

[11] 2016406.3M003

[15] 24-06-2020

[51] Cl. 21-01

[54] 積木

Building box

[73] 佳樂專有限公司

Kalos Blocks Company Limited

9/F., Southeast Industrial Building,

611-619 Castle Peak Road,

Tsuen Wan, Hong Kong

[74] HONG KONG INTELLECTUAL PROPERTY ADVISORY SERVICE LIMITED

Unit 1701, 17/F., Ew International Tower,

120 Texaco Road,

Tsuen Wan, New Territories,

Hong Kong

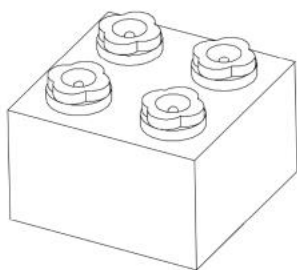

[11] 2016406.3M004

[15] 24-06-2020

[51] Cl. 21-01

[54] 積木

Building box

[73] 佳樂專有限公司

Kalos Blocks Company Limited

9/F., Southeast Industrial Building,

611-619 Castle Peak Road,

Tsuen Wan, Hong Kong

[74] HONG KONG INTELLECTUAL PROPERTY ADVISORY SERVICE LIMITED

Unit 1701, 17/F., Ew International Tower,

120 Texaco Road,

Tsuen Wan, New Territories,

Hong Kong

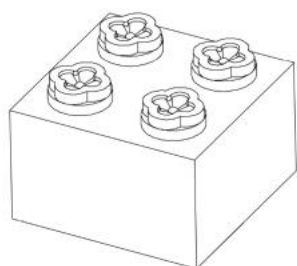

[11] 2016406.3M005

[15] 24-06-2020

[51] Cl. 21-01

[54] 積木

Building box

[73] 佳樂專有限公司

Kalos Blocks Company Limited
9/F., Southeast Industrial Building,
611-619 Castle Peak Road,
Tsuen Wan, Hong Kong

[74] HONG KONG INTELLECTUAL PROPERTY ADVISORY SERVICE LIMITED

Unit 1701, 17/F., Ew International Tower,
120 Texaco Road,
Tsuen Wan, New Territories,
Hong Kong

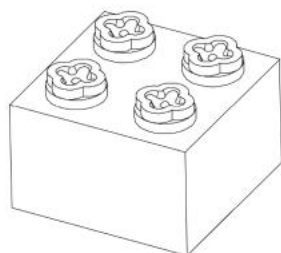

[11] 2016406.3M006

[15] 24-06-2020

[51] Cl. 21-01

[54] 積木

Building box

[73] 佳樂專有限公司

Kalos Blocks Company Limited

9/F., Southeast Industrial Building,
611-619 Castle Peak Road,
Tsuen Wan, Hong Kong

- [74] HONG KONG INTELLECTUAL PROPERTY ADVISORY SERVICE LIMITED
Unit 1701, 17/F., Ew International Tower,
120 Texaco Road,
Tsuen Wan, New Territories,
Hong Kong

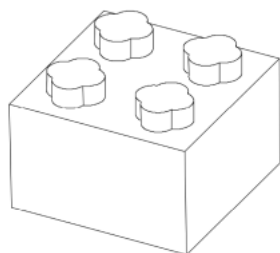

[11] 2016406.3M007

[15] 24-06-2020

[51] Cl. 21-01

[54] 積木

Building box

[73] 佳樂專有限公司

Kalos Blocks Company Limited

9/F., Southeast Industrial Building,

611-619 Castle Peak Road,

Tsuen Wan, Hong Kong

- [74] HONG KONG INTELLECTUAL PROPERTY ADVISORY SERVICE LIMITED
Unit 1701, 17/F., Ew International Tower,
120 Texaco Road,
Tsuen Wan, New Territories,
Hong Kong

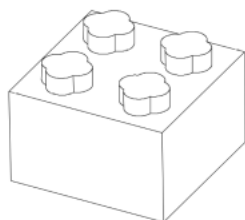

[11] 2016407.5

- [15] 26-06-2020
[30] 04-06-2020 / JP / 011009 of 2020
[51] Cl. 15-07
[54] 電冰箱
Refrigerator
[73] SHARP KABUSHIKI KAISHA
1 Takumi-cho, Sakai-ku,
Sakai City, Osaka 590-8522,
Japan
[74] WILKINSON & GRIST
6th Floor, Prince's Building,
Chater Road,
Hong Kong

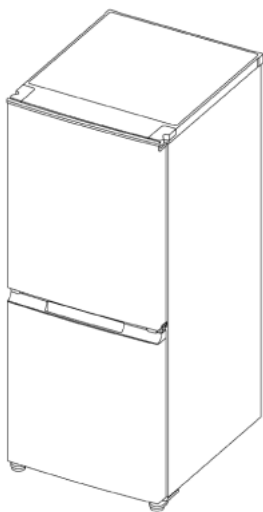

-
- [11] 2016408.7
[15] 26-06-2020
[51] Cl. 11-01
[54] 手鏈
Bracelet
[73] 古名晉
Koo Koon Man
Shop 116, Windsor House,
Causeway Bay,
Hong Kong
[74] ACCOLADE IP LIMITED
10/F, Fu Fai Comm. Ctr.,
27 Hillier Street, Sheung Wan,
Hong Kong



[11] 2016409.9

[15] 29-06-2020

[51] Cl. 7-02

[54] 小吃造型用托盤

Tray for snack molding

[73] KRACIE FOODS, LTD.

20-20, Kaigan 3-chome,
Minato-ku, Tokyo 108-8080,
Japan

[74] UNION PATENT SERVICE CENTRE

Units E-F, 20th Floor, Neich Tower,
128 Gloucester Road,
Hong Kong



[11] 2016410.1

[15] 29-06-2020

[51] Cl. 23-04

[54] 帶衣物干燥功能的除濕器

Dehumidifier with clothes dryer function

[73] 松下知識產權經營株式會社

Panasonic Intellectual Property Management Co., Ltd.

1-61, Shiromi 2-chome,
Chuo-ku, Osaka-shi, Osaka 540-6207,
Japan

- [74] MARKS & CLERK
Level 9, Cyberport 1,
100 Cyberport Road, Pok Fu Lam,
Hong Kong

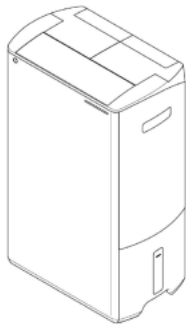

-
- [11] 2016411.3
[15] 29-06-2020
[51] Cl. 9-03
[54] 自動販賣機所銷售商品的包裝盒
Container for product packaging for selling in a vending
machine
[73] I Love You Inc.
16192 Coastal Highway,
Lewes, DE 19958,
United States
[74] I Love You Inc.
Unit 1, 11/F, Wing Sum Factory Building No.2,
12-14 Sam Chuk Street,
San Po Kong, Hong Kong



[11] 2016412.5M001

[15] 29-06-2020

[51] Cl. 11-01

[54] 錢幣造型洋紫荊純銀吊墜連琺瑯彩

Coin shaped bauhinia sterling silver pendant with enamel

[73] 《葉宣恒》以《狼創(香港)有限公司》之名營業

香港

中環鴨巴甸街 35 號

元創方 B 座 H310

[74] 狼創(香港)有限公司

香港

中環鴨巴甸街 35 號

元創方 B 座 H310



[11] 2016412.5M002

[15] 29-06-2020

[51] Cl. 11-01

[54] 錢幣造型香港帆船純銀吊墜連琺瑯彩

Coin shaped Hong Kong yacht sterling silver pendant with enamel

[73] 《葉宣恒》以《狼創(香港)有限公司》之名營業

香港

中環鴨巴甸街 35 號

元創方 B 座 H310

[74] 狼創(香港)有限公司

香港

中環鴨巴甸街 35 號

元創方 B 座 H310



[11] 2016416.4M001

[15] 30-06-2020

[30] 30-12-2019 / EU / 007461603

[51] Cl. 12-08

[54] 汽車

Car

[73] FERRARI S.p.A.

Via Emilia Est 1163,

I-41100 Modena,

Italy

[74] CHINA PATENT AGENT (HONG KONG) LIMITED

22/F, Great Eagle Centre,

23 Harbour Road,

Wanchai, Hong Kong

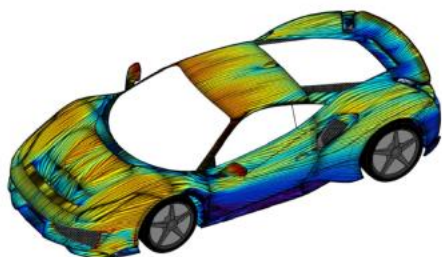

[11] 2016416.4M002

[15] 30-06-2020

[30] 30-12-2019 / EU / 007461603

[51] Cl. 12-08

[54] 汽車

Car

- [73] FERRARI S.p.A.
Via Emilia Est 1163,
I-41100 Modena,
Italy
- [74] CHINA PATENT AGENT (HONG KONG) LIMITED
22/F, Great Eagle Centre,
23 Harbour Road,
Wanchai, Hong Kong

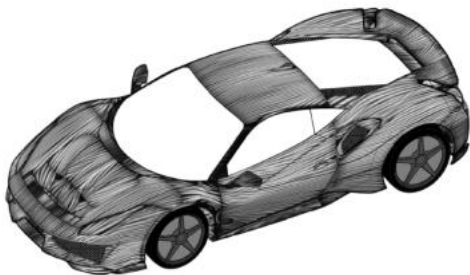

-
- [11] 2016417.6M001
- [15] 30-06-2020
- [30] 09-01-2020 / US / 29/720,115
- [51] Cl. 13-02
- [54] 醫療設備電池
Battery pack for medical device
- [73] ViOptix, Inc.
39655 Eureka Drive,
Newark, CA 94560,
United States
- [74] ELLALAN
26th and 28th Floors, The Hennessy,
256 Hennessy Road,
Wanchai, Hong Kong

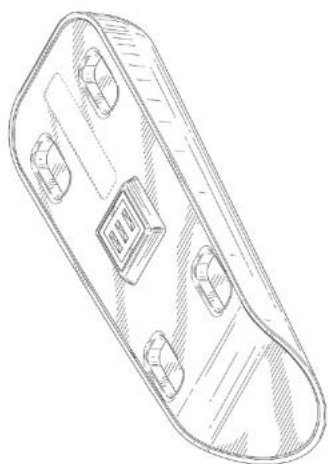

[11] 2016417.6M002

[15] 30-06-2020

[30] 09-01-2020 / US / 29/720,115

[51] Cl. 13-02

[54] 醫療設備電池

Battery pack for medical device

[73] ViOptix, Inc.

39655 Eureka Drive,

Newark, CA 94560,

United States

[74] ELLALAN

26th and 28th Floors, The Hennessy,

256 Hennessy Road,

Wanchai, Hong Kong

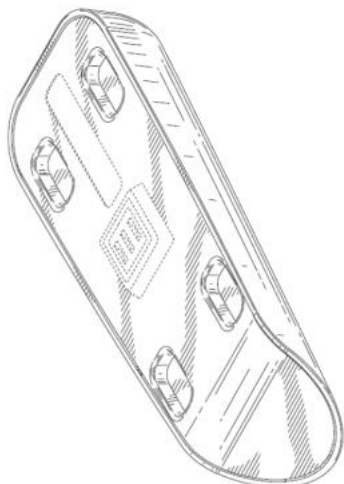

- [11] 2016417.6M003
[15] 30-06-2020
[30] 09-01-2020 / US / 29/720,115
[51] Cl. 13-02
[54] 醫療設備電池
Battery pack for medical device
[73] ViOptix, Inc.
39655 Eureka Drive,
Newark, CA 94560,
United States
[74] ELLALAN
26th and 28th Floors, The Hennessy,
256 Hennessy Road,
Wanchai, Hong Kong



-
- [11] 2016417.6M004
[15] 30-06-2020
[30] 09-01-2020 / US / 29/720,115
[51] Cl. 13-02
[54] 醫療設備電池
Battery pack for medical device
[73] ViOptix, Inc.
39655 Eureka Drive,
Newark, CA 94560,
United States
[74] ELLALAN
26th and 28th Floors, The Hennessy,
256 Hennessy Road,
Wanchai, Hong Kong

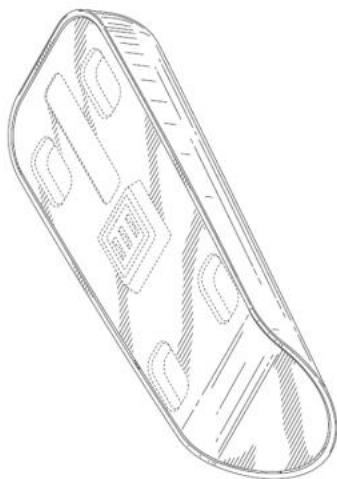

[11] 2016417.6M005

[15] 30-06-2020

[30] 09-01-2020 / US / 29/720,115

[51] Cl. 13-02

[54] 醫療設備電池

Battery pack for medical device

[73] ViOptix, Inc.

39655 Eureka Drive,

Newark, CA 94560,

United States

[74] ELLALAN

26th and 28th Floors, The Hennessy,

256 Hennessy Road,

Wanchai, Hong Kong



- [11] 2016417.6M006
[15] 30-06-2020
[30] 09-01-2020 / US / 29/720,115
[51] Cl. 13-02
[54] 醫療設備電池
Battery pack for medical device
[73] ViOptix, Inc.
39655 Eureka Drive,
Newark, CA 94560,
United States
[74] ELLALAN
26th and 28th Floors, The Hennessy,
256 Hennessy Road,
Wanchai, Hong Kong

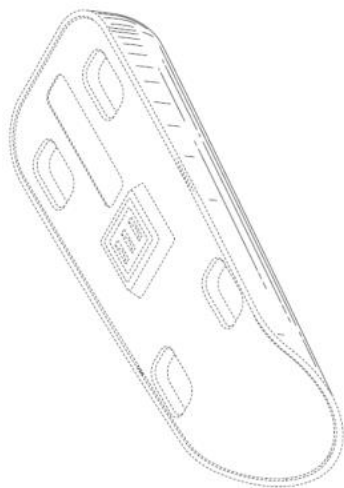

-
- [11] 2016418.8M001
[15] 30-06-2020
[30] 09-01-2020 / US / 29/720,120
[51] Cl. 24-02
[54] 用於醫療設備的套
Sheath for medical device
[73] ViOptix, Inc.
39655 Eureka Drive,
Newark, CA 94560,
United States
[74] ELLALAN
26th and 28th Floors, The Hennessy,
256 Hennessy Road,
Wanchai, Hong Kong

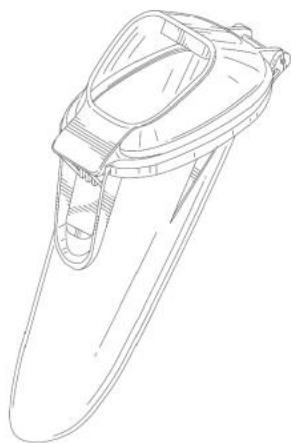

[11] 2016418.8M002

[15] 30-06-2020

[30] 09-01-2020 / US / 29/720,120

[51] Cl. 24-02

[54] 用於醫療設備的套

Sheath for medical device

[73] ViOptix, Inc.

39655 Eureka Drive,

Newark, CA 94560,

United States

[74] ELLALAN

26th and 28th Floors, The Hennessy,

256 Hennessy Road,

Wanchai, Hong Kong

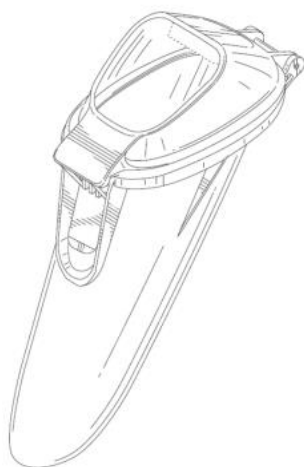

- [11] 2016418.8M003
[15] 30-06-2020
[30] 09-01-2020 / US / 29/720,120
[51] Cl. 24-02
[54] 用於醫療設備的套
Sheath for medical device
[73] ViOptix, Inc.
39655 Eureka Drive,
Newark, CA 94560,
United States
[74] ELLALAN
26th and 28th Floors, The Hennessy,
256 Hennessy Road,
Wanchai, Hong Kong

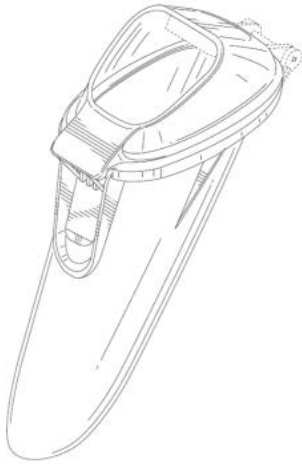

-
- [11] 2016418.8M004
[15] 30-06-2020
[30] 09-01-2020 / US / 29/720,120
[51] Cl. 24-02
[54] 用於醫療設備的套
Sheath for medical device
[73] ViOptix, Inc.
39655 Eureka Drive,
Newark, CA 94560,
United States
[74] ELLALAN
26th and 28th Floors, The Hennessy,
256 Hennessy Road,
Wanchai, Hong Kong

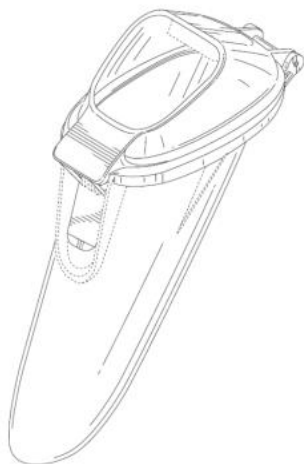

[11] 2016418.8M005

[15] 30-06-2020

[30] 09-01-2020 / US / 29/720,120

[51] Cl. 24-02

[54] 用於醫療設備的套

Sheath for medical device

[73] ViOptix, Inc.

39655 Eureka Drive,

Newark, CA 94560,

United States

[74] ELLALAN

26th and 28th Floors, The Hennessy,

256 Hennessy Road,

Wanchai, Hong Kong

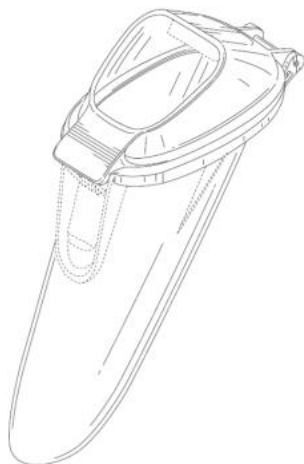

[11] 2016419.0M001

[15] 30-06-2020

[30] 09-01-2020 / US / 29/720,112

[51] Cl. 24-02

[54] 醫療設備

Medical device

[73] ViOptix, Inc.

39655 Eureka Drive,

Newark, CA 94560,

United States

[74] ELLALAN

26th and 28th Floors, The Hennessy,

256 Hennessy Road,

Wanchai, Hong Kong

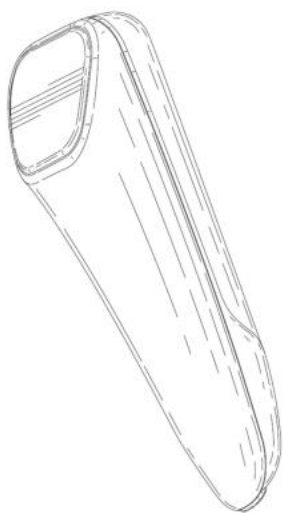

[11] 2016419.0M002

[15] 30-06-2020

[30] 09-01-2020 / US / 29/720,112

[51] Cl. 24-02

[54] 醫療設備

Medical device

[73] ViOptix, Inc.

39655 Eureka Drive,

Newark, CA 94560,

United States

[74] ELLALAN

26th and 28th Floors, The Hennessy,

256 Hennessy Road,

Wanchai, Hong Kong

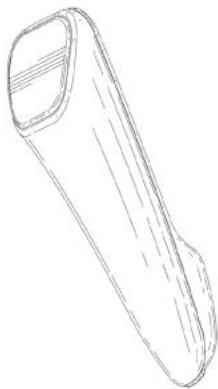

[11] 2016419.0M003

[15] 30-06-2020

[30] 09-01-2020 / US / 29/720,112

[51] Cl. 24-02

[54] 醫療設備

Medical device

[73] ViOptix, Inc.

39655 Eureka Drive,

Newark, CA 94560,

United States

[74] ELLALAN

26th and 28th Floors, The Hennessy,

256 Hennessy Road,

Wanchai, Hong Kong

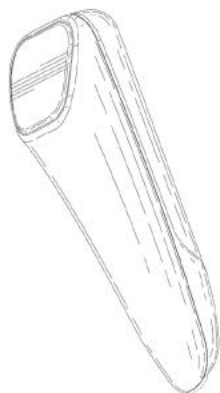

- [11] 2016419.0M004
[15] 30-06-2020
[30] 09-01-2020 / US / 29/720,112
[51] Cl. 24-02
[54] 醫療設備
Medical device
[73] ViOptix, Inc.
39655 Eureka Drive,
Newark, CA 94560,
United States
[74] ELLALAN
26th and 28th Floors, The Hennessy,
256 Hennessy Road,
Wanchai, Hong Kong

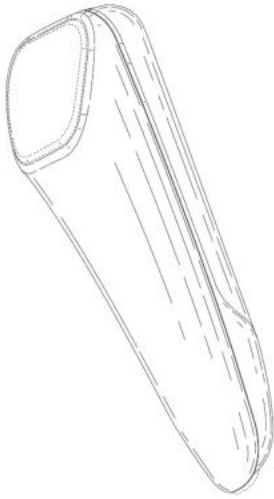

-
- [11] 2016419.0M005
[15] 30-06-2020
[30] 09-01-2020 / US / 29/720,112
[51] Cl. 24-02
[54] 醫療設備
Medical device
[73] ViOptix, Inc.
39655 Eureka Drive,
Newark, CA 94560,
United States
[74] ELLALAN
26th and 28th Floors, The Hennessy,
256 Hennessy Road,
Wanchai, Hong Kong

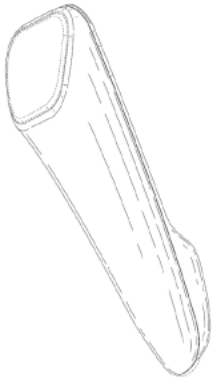

[11] 2016419.0M006

[15] 30-06-2020

[30] 09-01-2020 / US / 29/720,112

[51] Cl. 24-02

[54] 醫療設備

Medical device

[73] ViOptix, Inc.

39655 Eureka Drive,

Newark, CA 94560,

United States

[74] ELLALAN

26th and 28th Floors, The Hennessy,

256 Hennessy Road,

Wanchai, Hong Kong

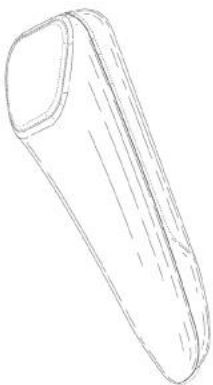

- [11] 2016419.0M007
[15] 30-06-2020
[30] 09-01-2020 / US / 29/720,112
[51] Cl. 24-02
[54] 醫療設備
Medical device
[73] ViOptix, Inc.
39655 Eureka Drive,
Newark, CA 94560,
United States
[74] ELLALAN
26th and 28th Floors, The Hennessy,
256 Hennessy Road,
Wanchai, Hong Kong

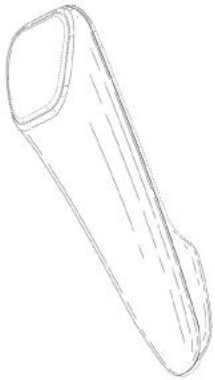

-
- [11] 2016420.2M001
[15] 30-06-2020
[30] 10-01-2020 / US / 29/720,282
[51] Cl. 14-04
[54] 帶有動態圖形用戶界面的顯示屏或顯示屏的一部分
Display screen or portion thereof with animated graphical user interface
[73] ILLUMINA, INC.
5200 Illumina Way,
San Diego, CA 92122,
United States
[74] WILKINSON & GRIST
6th Floor, Prince's Building,
Chater Road,
Hong Kong



[11] 2016420.2M002

[15] 30-06-2020

[30] 10-01-2020 / US / 29/720,282

[51] Cl. 14-04

[54] 帶有動態圖形用戶界面的顯示屏或顯示屏的一部分

Display screen or portion thereof with animated graphical user interface

[73] ILLUMINA, INC.

5200 Illumina Way,
San Diego, CA 92122,
United States

[74] WILKINSON & GRIST

6th Floor, Prince's Building,
Chater Road,
Hong Kong



[11] 2016421.4M001

[15] 30-06-2020

[30] 10-01-2020 / US / 29/720,280

[51] Cl. 14-04

[54] 帶有動態圖形用戶界面的顯示屏或顯示屏的一部分

Display screen or portion thereof with animated graphical user interface

[73] ILLUMINA, INC.

5200 Illumina Way,

San Diego, CA 92122,
United States

- [74] WILKINSON & GRIST
6th Floor, Prince's Building,
Chater Road,
Hong Kong



-
- [11] 2016421.4M002
 - [15] 30-06-2020
 - [30] 10-01-2020 / US / 29/720,280
 - [51] Cl. 14-04
 - [54] 帶有動態圖形用戶界面的顯示屏或顯示屏的一部分
Display screen or portion thereof with animated graphical user interface
 - [73] ILLUMINA, INC.
5200 Illumina Way,
San Diego, CA 92122,
United States
 - [74] WILKINSON & GRIST
6th Floor, Prince's Building,
Chater Road,
Hong Kong



-
- [11] 2016423.8
 - [15] 30-06-2020
 - [30] 24-01-2020 / JP / 001168 of 2020

[51] Cl. 6-09

[54] 姿勢保持器

Posture keeping device

[73] 株式會社 MTG

MTG Co., Ltd.

32, Honjin-Dori 2-Chome, Nakamura-Ku, Nagoya-Shi, Aichi-Ken

453-0041,

Japan

[74] CHINAHONGKONG IP LIMITED

3011, 30/F, Office Tower, Convention Plaza,

1 Harbour Road,

Hong Kong

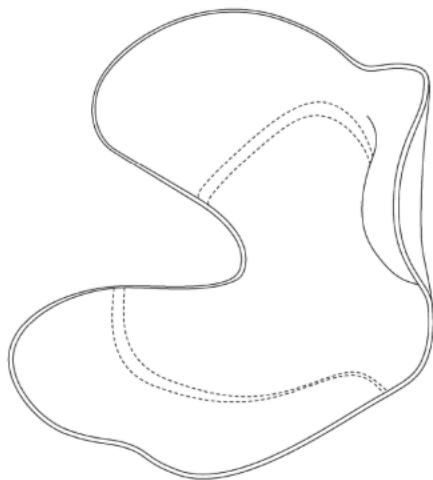

[11] 2016424.0

[15] 30-06-2020

[30] 02-04-2020 / SG / 30202007843Y

[51] Cl. 9-03

[54] 具有浮雕圖案的罐

Can with embossed pattern

[73] CROWN Packaging Technology, Inc.

11535 South Central Avenue, Alsip,

Illinois 60803-2599,

United States

[74] MARKS & CLERK

Level 9, Cyberport 1,

100 Cyberport Road,

Pok Fu Lam, Hong Kong

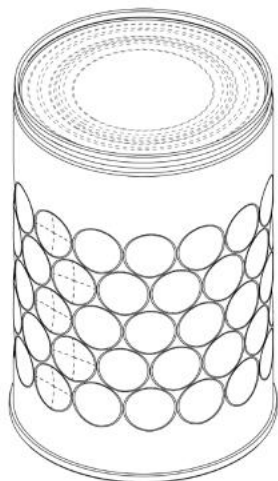

[11] 2016425.3

[15] 30-06-2020

[51] Cl. 9-03

[54] 包裝盒

Packing box

[73] 東阿阿膠股份有限公司

中國內地

山東省東阿縣

阿膠街 78 號

[74] 環球知識產權代理有限公司

香港九龍

尖沙咀東麼地道 62 號

永安廣場 12 樓 1213 室



- [11] 2016426.5
[15] 30-06-2020
[51] Cl. 19-02
[54] 墨水容器
Ink container
[73] PIERRE CARDIN LICENSE HOLDING LIMITED
Unit 1728, 17/F., Ocean Centre, Harbour City,
5 Canton Road,
Tsimshatsui, Kowloon, Hong Kong
[74] IMARKET LICENSING LIMITED
Rm 1008, Prosperity Millennia Plaza,
663 King's Road,
Quarry Bay, Hong Kong

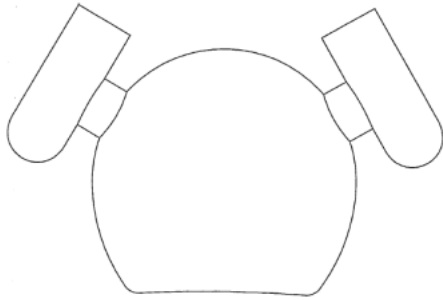

-
- [11] 2016427.7
[15] 30-06-2020
[30] 30-12-2019 / CN / 201930741359.8
[51] Cl. 9-08
[54] 地台板
Pallet
[73] 李海維
Haiwei LI
中國內地
廣東省江門市鶴山沙坪鎮中山二巷 28 號之一 602 房 (郵編: 529700)

張毅鵬
Yipeng ZHANG
中國內地
廣東省江門市鶴山沙坪鎮中山二巷 28 號之一 602 房 (郵編: 529700)
[74] 中港專利有限公司
香港

港灣道 1 號會展廣場
辦公大樓 30 樓 3012 室

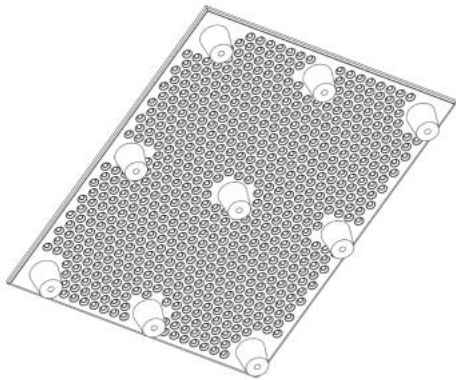

[11] 2016428.9M001

[15] 30-06-2020

[51] Cl. 11-01

[54] 首飾

Jewellery

[73] Chow Tai Fook Jewellery Company Limited

38/F, New World Tower,
16-18 Queen's Road Central,
Hong Kong

[74] DEACONS

5th Floor, Alexandra House,
Central,
Hong Kong



[11] 2016428.9M002

[15] 30-06-2020

[51] Cl. 11-01

[54] 首飾

Jewellery

[73] Chow Tai Fook Jewellery Company Limited

38/F, New World Tower,

16-18 Queen's Road Central,

Hong Kong

[74] DEACONS

5th Floor, Alexandra House,

Central,

Hong Kong



[11] 2016428.9M003

[15] 30-06-2020

[51] Cl. 11-01

[54] 首飾

Jewellery

[73] Chow Tai Fook Jewellery Company Limited

38/F, New World Tower,

16-18 Queen's Road Central,

Hong Kong

[74] DEACONS

5th Floor, Alexandra House,

Central,

Hong Kong



[11] 2016428.9M004

[15] 30-06-2020

[51] Cl. 11-01

[54] 首飾

Jewellery

[73] Chow Tai Fook Jewellery Company Limited

38/F, New World Tower,
16-18 Queen's Road Central,
Hong Kong

[74] DEACONS

5th Floor, Alexandra House,
Central,
Hong Kong



[11] 2016428.9M005

[15] 30-06-2020

[51] Cl. 11-01

[54] 首飾

Jewellery

[73] Chow Tai Fook Jewellery Company Limited

38/F, New World Tower,
16-18 Queen's Road Central,
Hong Kong

[74] DEACONS

5th Floor, Alexandra House,
Central,
Hong Kong



[11] 2016428.9M006

[15] 30-06-2020

[51] Cl. 11-01

[54] 首飾

Jewellery

[73] Chow Tai Fook Jewellery Company Limited

38/F, New World Tower,
16-18 Queen's Road Central,
Hong Kong

[74] DEACONS

5th Floor, Alexandra House,
Central,
Hong Kong



[11] 2016430.3

[15] 03-07-2020

[51] Cl. 24-02

[54] 皮膚護理設備手柄

Handpiece for skin care device

[73] 科萊希思有限公司

CLASSYS INC.

240, Teheran-Ro,

Gangnam-gu, Seoul 06221,

Korea, Republic of

[74] CHINA PATENT AGENT (HONG KONG) LIMITED

22/F, Great Eagle Centre,

23 Harbour Road,

Wanchai, Hong Kong

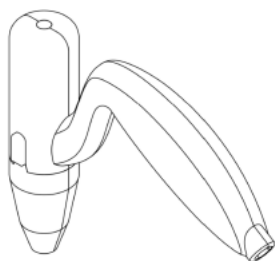

[11] 2016433.9

[15] 03-07-2020

[51] Cl. 23-04

[54] 香薰機

Aroma diffuser

[73] 盛開蓮花有限公司

Bloomy Lotus Ltd

Unit 4711, 47/F., The Center,

99 Queen's Road Central,

Central, Hong Kong

[74] FEDERATION OF HONG KONG INDUSTRIES

31/F, Billion Plaza,

8 Cheung Yue Street,

Cheung Sha Wan, Kowloon, Hong Kong



[11] 2016436.6

[15] 06-07-2020

[51] C1. 2-02

[54] 可拆換肩帶背心衣

Removable and changeable shoulder strap vest

[73] 盧佩盈

Lou Pui Ying

香港將軍澳

厚德邨

德康樓 3 樓 04 室

[74] 盧佩盈

香港將軍澳

厚德邨

德康樓 3 樓 04 室

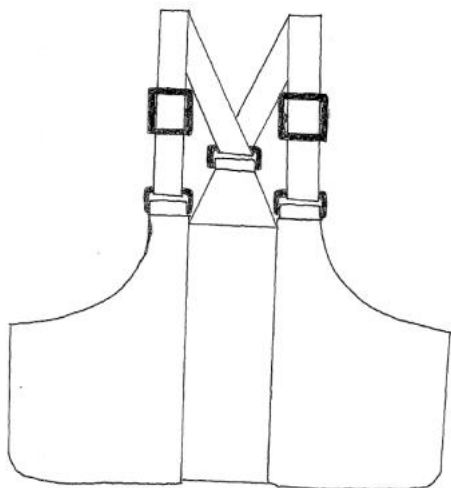

[11] 2016437.8

[15] 06-07-2020

[51] Cl. 25-03

[54] 太陽能休息站

Solar pavilion

[73] LEUNG WAI ON

Unit 601 & 602, Lakeside 2,
No. 10 Science Park West Avenue, Phase II,
Hong Kong Science Park, Shatin, N.T.,
Hong Kong

[74] LEUNG WAI ON

Unit 601 & 602, Lakeside 2,
No. 10, Science Park West Avenue, Phase II,
Hong Kong Science Park, Shatin, N.T.,
Hong Kong



[11] 2016438.0

[15] 06-07-2020

[51] Cl. 23-04

[54] 香薰機

Aroma diffuser

[73] 璞真生活有限公司

PUZHEN LIFE CO., LTD

Unit 1112-1116, 11/F, Delta House,

3 On Yiu Street,

Shatin, Hong Kong

[74] FEDERATION OF HONG KONG INDUSTRIES

31/F, Billion Plaza,

8 Cheung Yue Street,

Cheung Sha Wan, Kowloon,

Hong Kong



[11] 2016439.2

[15] 06-07-2020

[51] Cl. 23-04

[54] 香薰機

Aroma diffuser

[73] 璞真生活有限公司

PUZHEN LIFE CO., LTD

Unit 1112-1116, 11/F, Delta House,

3 On Yiu Street,

Shatin, Hong Kong

[74] FEDERATION OF HONG KONG INDUSTRIES

31/F, Billion Plaza,

8 Cheung Yue Street,

Cheung Sha Wan, Kowloon,

Hong Kong



[11] 2016442.8M001

[15] 07-07-2020

[30] 19-03-2020 / SG, CH, US, EU, JP, KR / DM/207 409

[51] Cl. 10-07

[54] 手錶時針

Watch hand

[73] PATEK PHILIPPE SA GENEVE

Rue du Rhône 41,

1204 Geneva,

Switzerland

[74] WILKINSON & GRIST

6th Floor, Prince's Building,

Chater Road,

Hong Kong



[11] 2016442.8M002

[15] 07-07-2020

[30] 19-03-2020 / SG, CH, US, EU, JP, KR / DM/207 409

[51] Cl. 10-07

[54] 手錶時針

Watch hand

[73] PATEK PHILIPPE SA GENEVE

Rue du Rhône 41,

1204 Geneva,
Switzerland

[74] WILKINSON & GRIST
6th Floor, Prince's Building,
Chater Road,
Hong Kong



[11] 2016442.8M003

[15] 07-07-2020

[30] 19-03-2020 / SG, CH, US, EU, JP, KR / DM/207 409

[51] Cl. 10-07

[54] 手錶時針

Watch hand

[73] PATEK PHILIPPE SA GENEVE

Rue du Rhône 41,

1204 Geneva,

Switzerland

[74] WILKINSON & GRIST

6th Floor, Prince's Building,

Chater Road,

Hong Kong



[11] 2016442.8M004

[15] 07-07-2020

[30] 19-03-2020 / SG, CH, US, EU, JP, KR / DM/207 409

[51] Cl. 10-07

[54] 手錶時針

Watch hand

[73] PATEK PHILIPPE SA GENEVE

Rue du Rhône 41,

1204 Geneva,

Switzerland

[74] WILKINSON & GRIST
6th Floor, Prince's Building,
Chater Road,
Hong Kong



[11] 2016442.8M005

[15] 07-07-2020

[30] 19-03-2020 / SG, CH, US, EU, JP, KR / DM/207 409

[51] Cl. 10-07

[54] 手錶時針

Watch hand

[73] PATEK PHILIPPE SA GENEVE

Rue du Rhône 41,

1204 Geneva,

Switzerland

[74] WILKINSON & GRIST

6th Floor, Prince's Building,

Chater Road,

Hong Kong

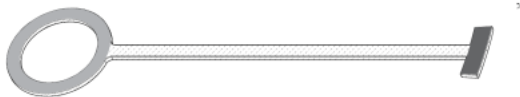

[11] 2016443.0

[15] 07-07-2020

[51] Cl. 20-01

[54] 智能生鮮自提櫃

Intelligent fresh vending machine

[73] 深圳市便易通科技有限公司

Shenzhen Bianyi Technology Co., Ltd.

中國內地

廣東省深圳市龍崗區

龍崗街道中心城天安數碼新城 2 棟 B 座 1403

[74] HONG KONG DECENT INTELLECTUAL PROPERTY AGENT LIMITED

香港

文咸東街 78 號
華東商業大廈三樓



[11] 2016444.2

[15] 07-07-2020

[51] Cl. 7-10

[54] 智能冷藏櫃

Intelligent refrigerator

[73] 深圳市便易通科技有限公司

Shenzhen Bianyi Technology Co., Ltd.

中國內地

廣東省深圳市龍崗區

龍崗街道中心城天安數碼新城 2 棟 B 座 1403

[74] HONG KONG DECENT INTELLECTUAL PROPERTY AGENT LIMITED

香港

文咸東街 78 號

華東商業大廈三樓



[11] 2016446.7M001

[15] 07-07-2020

[30] 09-01-2020 / US / 29/720,106

[51] Cl. 24-01

[54] 光療設備

Light therapy device

[73] Bausch Health Ireland Limited

3013 Lake Drive, Citywest Business Campus, Dublin, Ireland 24,
Ireland

[74] LIU, SHEN & ASSOCIATES

Room 3716, 37/F, Sun Hung Kai Centre,
30 Harbour Road,
Wanchai, Hong Kong



[11] 2016446.7M002

[15] 07-07-2020

[30] 09-01-2020 / US / 29/720,107

[51] Cl. 24-01

[54] 光療設備

Light therapy device

[73] Bausch Health Ireland Limited

3013 Lake Drive, Citywest Business Campus, Dublin, Ireland 24,
Ireland

[74] LIU, SHEN & ASSOCIATES

Room 3716, 37/F, Sun Hung Kai Centre,
30 Harbour Road,
Wanchai, Hong Kong



[11] 2016446.7M003

[15] 07-07-2020

[30] 09-01-2020 / US / 29/720,109

[51] Cl. 24-01

[54] 光療設備

Light therapy device

[73] Bausch Health Ireland Limited

3013 Lake Drive, Citywest Business Campus, Dublin, Ireland 24,
Ireland

[74] LIU, SHEN & ASSOCIATES

Room 3716, 37/F, Sun Hung Kai Centre,
30 Harbour Road,
Wanchai, Hong Kong

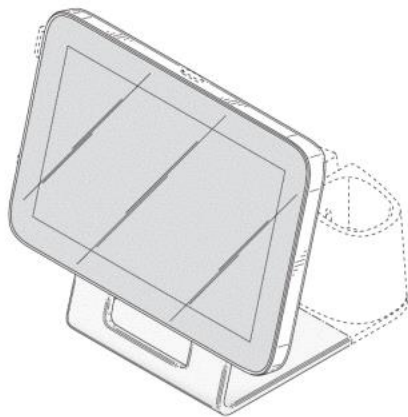

[11] 2016449.3

[15] 07-07-2020

[30] 10-06-2020 / CA, EG, AM, KP, MX, MC, MA, NO, RU, SG, CH, TN,
TR, UA, US, VN, EU, IS, IL, JP, KR / WIPO95568

[51] Cl. 7-05

[54] 清洗劑容器
Washing agent container

[73] Daan Technologies SAS
ZA du Mortier Est,
85610 Cugand,
France

[74] OLDHAM LI & NIE SOLICITORS
503, St. George's Building,
2 Ice House Street,
Central, Hong Kong



[11] 2016450.5

[15] 08-07-2020

[30] 15-01-2020 / MC, SG, CH, TR, UA, GB / DM/205 511

[51] Cl. 10-02

[54] 錶
Watch

[73] Parmigiani Fleurier S.A.
11, Rue du Temple,
2114 Fleurier,
Switzerland

[74] UNION PATENT SERVICE CENTRE
Units E-F, 20th Floor, Neich Tower,
128 Gloucester Road,
Hong Kong



[11] 2016451.7

- [15] 08-07-2020
- [30] 15-01-2020 / MC, SG, CH, TR, UA, GB, EU / DM/205 511
- [51] Cl. 10-07
- [54] 錶面
Watch dial
- [73] Parmigiani Fleurier S.A.
11, Rue du Temple,
2114 Fleurier,
Switzerland
- [74] UNION PATENT SERVICE CENTRE
Units E-F, 20th Floor, Neich Tower,
128 Gloucester Road,
Hong Kong

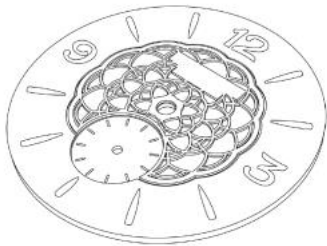

-
- [11] 2016455.6
- [15] 08-07-2020
- [30] 15-01-2020 / KR / 30-2020-0001835
- [51] Cl. 3-01
- [54] 包
A bag
- [73] 崔敬峨
CHOI, Kyoung Ah
#10-1205, 71, Apgujeong-ro 29-gil,
Gangnam-gu, Seoul, 06002,
Korea, Republic of
- [74] ACCOLADE IP LIMITED
10/F, Fu Fai Comm. Ctr.,
27 Hillier Street,
Sheung Wan, Hong Kong



[11] 2016456.8M001

[15] 08-07-2020

[30] 05-06-2020 / CN / 202030278772.8

[51] C1. 29-02

[54] 可複用防病毒面罩

Reusable and anti-virus face mask

[73] 嘉瑞製品有限公司

Ka Shui Manufactory Co., Ltd.

香港九龍灣

宏光道一號

億京中心 B 座 29 樓 A 室

[74] 中港專利有限公司

香港

港灣道 1 號會展廣場

辦公大樓 30 樓 3012 室

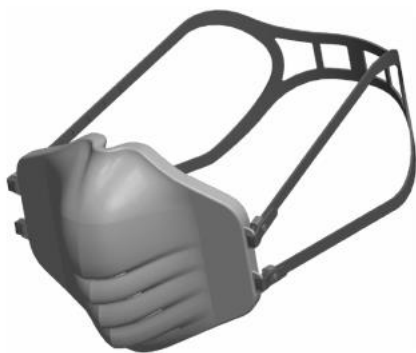

[11] 2016456.8M002

[15] 08-07-2020

[30] 05-06-2020 / CN / 202030278772.8

[51] C1. 29-02

[54] 可複用防病毒面罩
Reusable and anti-virus face mask

[73] 嘉瑞製品有限公司
Ka Shui Manufactory Co., Ltd.
香港九龍灣
宏光道一號
億京中心 B 座 29 樓 A 室

[74] 中港專利有限公司
香港
港灣道 1 號會展廣場
辦公大樓 30 樓 3012 室



[11] 2016457.0M001

[15] 09-07-2020

[51] Cl. 9-05

[54] 包裝袋
Packaging bag

[73] Old Henry Limited
Unit B, 7/F, Eastern Comm Ctr,
83 Nam On Street,
Shau Kei Wan, Hong Kong

[74] ACCOLADE IP LIMITED
10/F, Fu Fai Comm. Ctr.,
27 Hillier Street,
Sheung Wan, Hong Kong



[11] 2016457.0M002

[15] 09-07-2020

[51] Cl. 9-03

[54] 包裝盒

Packaging box

[73] Old Henry Limited

Unit B, 7/F, Eastern Comm Ctr,

83 Nam On Street,

Shau Kei Wan, Hong Kong

[74] ACCOLADE IP LIMITED

10/F, Fu Fai Comm. Ctr.,

27 Hillier Street,

Sheung Wan, Hong Kong





香港特別行政區政府知識產權署外觀設計註冊處

The Government of the Hong Kong Special Administrative Region

Designs Registry, Intellectual Property Department

根據註冊外觀設計條例第 28 條，下列註冊外觀設計因未繳續期費而停止有效。

各組記項按註冊外觀設計停止有效日期及註冊編號先後次序排列。

Registered designs ceased through non-payment of renewal fees under section 28 of the Registered Designs Ordinance. Entries are listed below under their expiry dates.

23-07-2020 - 28-07-2020

23-07-2020	1501640.5
1501621.5	1501641.7
1501624.1M001	1501642.9
1501624.1M002	
1501624.1M003	
1501624.1M004	
1501626.6	
1501627.8	

24-07-2020

0010955.7
0010957.1

25-07-2020

0501753.2M001
1001369.4
1001370.6
1001375.7

26-07-2020

1001387.2M001
1501629.2

27-07-2020

0010982.3M001
1501634.2M001
1501634.2M002
1501634.2M003
1501635.5

28-07-2020

1001397.3M001
1001398.5
1501637.9



香港特別行政區政府知識產權署外觀設計註冊處

The Government of the Hong Kong Special Administrative Region

Designs Registry, Intellectual Property Department

根據註冊外觀設計規則第 31 條刪除的註冊外觀設計。各組記項按註冊外觀設計刪除日期及註冊編號先後次序排列。

Registered designs removed under section 31 of the Registered Designs Rules. Entries are listed below under their removal dates.

12-09-2020 - 16-09-2020

12-09-2020	1500225.4M003
0500169.2M003	1500226.6M001
	1500226.6M002

13-09-2020

0010126.9
1000154.7
1500199.7
1500201.3
1500202.5

16-09-2020

1000177.6
1000178.8
1000180.2M001
1500231.6
1500237.9M001
1500237.9M002
1500237.9M003
1500237.9M004
1500237.9M005
1500237.9M006
1500238.1M001
1500238.1M002

14-09-2020

1000158.6
1000159.8
1000160.0
1500207.6
1500208.8

15-09-2020

0500188.2M004
0500188.2M005
0500188.2M006
0500188.2M007
0500189.4
1000167.5
1000168.7
1000172.5
1000173.7
1500210.2
1500211.4
1500220.3
1500221.5
1500222.7
1500225.4M001
1500225.4M002

1500239.3
1500240.5
1500241.7
1500242.9
1500243.1
1500244.3



香港特別行政區政府知識產權署外觀設計註冊處
The Government of the Hong Kong Special Administrative Region
Designs Registry, Intellectual Property Department

勘誤

CORRIGENDUM

已在官方公報刊登的外觀設計公告內的聲稱具有優先權更正如下：

**The following show the corrected priority claim in advertisement
previously published in the official journal:**

官方公報日期 Official journal date 03.07.2020

[11] 2015516.6M001-M007

[30] 02-08-2019 / MA, MC, SG, CH, TR, UA, GB, EU / DM/202 832