

香港知識產權公報

Hong Kong Intellectual Property Journal

2021年9月30日
30 September 2021

目錄 Contents

根據註冊外觀設計條例第 25 條註冊的外觀設計

Designs Registered under section 25 of the Registered Designs Ordinance

按註冊編號排列

Arranged by Registration Number

根據註冊外觀設計條例(第 522 章)公布的其他公告

Other Notices Published under the Registered Designs Ordinance (Cap. 522)

根據註冊外觀設計條例第 28 條，註冊外觀設計因未繳續期費而停止有效

Registered designs ceased through non-payment of renewal fees under section 28 of the Registered Designs Ordinance

根據註冊外觀設計規則第 31 條刪除的註冊外觀設計

Registered designs removed under section 31 of the Registered Designs Rules

勘誤

Corrigendum

以下事項沒有記錄

No Records for the Following Matters

根據註冊外觀設計條例第 30 條放棄的外觀設計的註冊

Surrender of Registration of Design under section 30 of the Registered Designs Ordinance

根據註冊外觀設計規則第 37 條，向處長作出轉介

Reference to Registrar under section 37 of the Registered Designs Rules

根據註冊外觀設計條例第 45 條，撤銷註冊

Revocation of Registration under section 45 of the Registered Designs Ordinance

根據註冊外觀設計規則第 46 條，向法院作出轉介

Reference to Court under section 46 of the Registered Designs Rules

根據註冊外觀設計規則第 63 條對不符合規定之處作出糾正

Rectification of Irregularities under section 63 of the Registered Designs Rules

根據註冊外觀設計條例第 66 條，糾正註冊紀錄冊

Rectification of Register under section 66 of the Registered Designs Ordinance

根據註冊外觀設計條例第 67 條 更正註冊紀錄冊內的錯誤

Correction of errors in Register under section 67 of the Registered Designs Ordinance

根據註冊外觀設計條例第 67 及 76 條，更正註冊紀錄冊內及已提交文件中的錯誤

Correction of Errors in Register and in Filed Documents under sections 67 and 76 of the Registered Designs Ordinance

根據註冊外觀設計條例第 76 條，更正已提交文件中的錯誤

Correction of errors in filed documents under section 76 of the Registered Designs Ordinance

註冊外觀設計公告註釋

Notes on advertisements of registration of designs

方括號表示下列資料：

Square brackets indicate the following data：

[11] 註冊編號 Registration number / 聯合王國註冊編號 United Kingdom registration number

[15] 註冊日期 Registration date / 當作註冊日期 Deemed registration date / 聯合王國註冊日期 United Kingdom registration date

[17] 註冊有效期屆滿日期 Expiry date of the period of registration

[22] 提交日期 Filing date / 當作提交日期 Deemed filing date / 聯合王國提交日期 United Kingdom filing date

[30] 聲稱享有的優先權（提交日期 / 巴黎公約國或世界貿易組織成員 / 申請編號） Priority claimed (filing date / Paris Convention country or WTO member / application number)

[51] 國際外觀設計分類號（洛迦諾分類號） International Classification of designs (Locarno Classification)

[54] 物品 Article

[55] 外觀設計的表述 Representation of the design

[62] 分開前的申請編號及提交日期 Application number before division and filing date

[66] 過往註冊的聯繫外觀設計註冊編號 / 日期 Registration No. / Date of Previous Registration for Association

[72] 設計人 Designer

[73] 擁有人姓名和地址 Name and address of the owner

[74] 代理人 Agent /送達地址 Address for service



香港特別行政區政府知識產權署外觀設計註冊處

The Government of the Hong Kong Special Administrative Region

Designs Registry, Intellectual Property Department

根據註冊外觀設計條例第 25 條註冊的外觀設計

Designs registered under section 25 of the Registered Designs Ordinance

按註冊編號排列

Arranged by Registration Number

[11] 2117600.7

[15] 18-02-2021

[51] Cl. 7-02

[54] 咖啡機

Coffee machine

[73] TUNBOW GROUP LIMITED

10/F, Block A, Chung Mei Centre,

No. 15 Hing Yip Street,

Kwun Tong, Kowloon, Hong Kong

[74] SIMON LEE

10/F, Block A, Chung Mei Centre,

No. 15 Hing Yip Street,

Kwun Tong, Kowloon, Hong Kong



[11] 2117601.9

[15] 18-02-2021

[51] Cl. 7-02

[54] 咖啡機

Coffee machine

[73] TUNBOW GROUP LIMITED
10/F, Block A, Chung Mei Centre,
No. 15 Hing Yip Street,
Kwun Tong, Kowloon, Hong Kong

[74] SIMON LEE
10/F, Block A, Chung Mei Centre,
No.15 Hing Yip Street,
Kwun Tong, Kowloon, Hong Kong



[11] 2117603.3

[15] 18-02-2021

[51] Cl. 7-02

[54] 咖啡機
Coffee machine

[73] TUNBOW GROUP LIMITED
10/F, Block A, Chung Mei Centre,
No.15 Hing Yip Street,
Kwun Tong, Kowloon, Hong Kong

[74] SIMON LEE
10/F, Block A, Chung Mei Centre,
No.15 Hing Yip Street,
Kwun Tong, Kowloon, Hong Kong



[11] 2117620.9

[15] 23-02-2021

[30] 24-08-2020 / NZ / 427934

[51] Cl. 6-06

[54] 座椅靠背

Backrest for chair

[73] Resero IP Limited

1128 Omaha Road,

Hastings 4175,

New Zealand

[74] Peter Shen & Co. Ltd.

Suite 801, 8th Floor, K. Wah Centre,

191 Java Road,

North Point, Hong Kong



[11] 2117621.1

[15] 23-02-2021

[30] 24-08-2020 / NZ / 427933

[51] Cl. 6-06

[54] 座椅靠背

Backrest for chair

[73] Resero IP Limited

1128 Omaha Road,

Hastings 4175,

New Zealand

[74] Peter Shen & Co. Ltd.

Suite 801, 8th Floor, K. Wah Centre,

191 Java Road,

North Point, Hong Kong

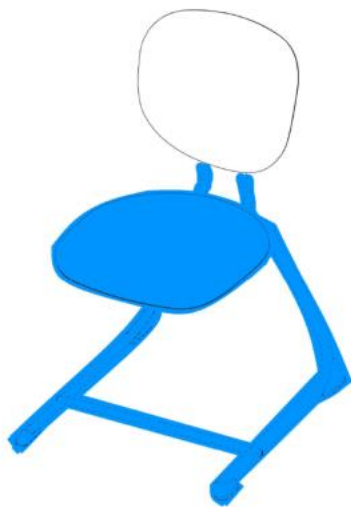

[11] 2117622.3

[15] 23-02-2021

[30] 24-08-2020 / NZ / 427933

[51] Cl. 6-01

[54] 椅子

Chair

[73] Resero IP Limited

1128 Omaha Road,

Hastings 4175,

New Zealand

[74] Peter Shen & Co. Ltd.

Suite 801, 8th Floor, K. Wah Centre,

191 Java Road,

North Point, Hong Kong

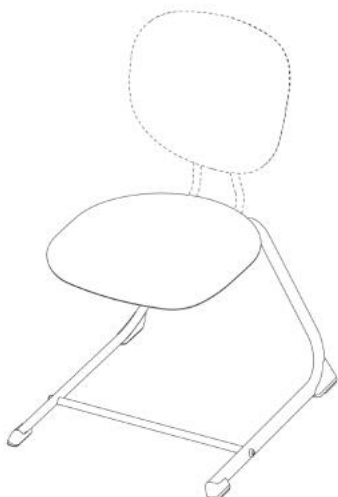

[11] 2117860.7

[15] 16-04-2021

[51] Cl. 7-02

[54] 咖啡機

Coffee machine

[73] TUNBOW GROUP LIMITED

10/F, Block A, Chung Mei Centre,

No.15 Hing Yip Street,

Kwun Tong, Kowloon, Hong Kong

[74] Simon Lee

10/F, Block A, Chung Mei Centre,

No.15 Hing Yip Street,

Kwun Tong, Kowloon, Hong Kong



[11] 2117861.9

[15] 16-04-2021

[51] Cl. 7-02

[54] 咖啡機

Coffee machine

[73] TUNBOW GROUP LIMITED

10/F, Block A, Chung Mei Centre,

No.15 Hing Yip Street,

Kwun Tong, Kowloon, Hong Kong

[74] SIMON LEE

10/F, Block A, Chung Mei Centre,

No.15 Hing Yip Street,

Kwun Tong, Kowloon, Hong Kong



[11] 2117862.1

[15] 16-04-2021

[51] Cl. 7-02

[54] 咖啡機

Coffee machine

[73] TUNBOW GROUP LIMITED

10/F, Block A, Chung Mei Centre,

No.15 Hing Yip Street,

Kwun Tong, Kowloon, Hong Kong

[74] Simon Lee

10/F, Block A, Chung Mei Centre,

No.15 Hing Yip Street,

Kwun Tong, Kowloon, Hong Kong



[11] 2117954.6

[15] 04-05-2021

[51] Cl. 26-05

[54] 發光二極管燈及其電源台

LED light with electrical power base

[73] 沈志溢

SUM CHI YAT

香港鰂魚涌

英皇道 1048 號

益發大廈 5 樓 4 室

[74] 沈志溢

香港鰂魚涌

英皇道 1048 號

益發大廈 5 樓 4 室



[11] 2117961.1M001

[15] 06-05-2021

[30] 26-11-2020 / EU / 008285985

[51] Cl. 23-08

[54] 廁紙盛載器

Toilet roll holder

- [73] Hansgrohe SE
Auestr. 5-9,
77761 Schiltach,
Germany
- [74] Rouse & Co. International (Overseas) Limited
26th Floor, Tesbury Centre
28 Queen's Road East, Wan Chai
Hong Kong

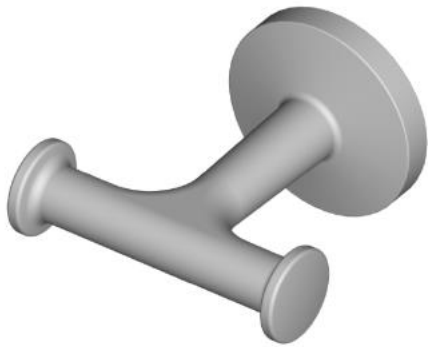

-
- [11] 2117961.1M002
- [15] 06-05-2021
- [30] 26-11-2020 / EU / 008285985
- [51] Cl. 23-08
- [54] 紙巾架
Napkin holder
- [73] Hansgrohe SE
Auestr. 5-9,
77761 Schiltach,
Germany
- [74] Rouse & Co. International (Overseas) Limited
26th Floor, Tesbury Centre
28 Queen's Road East, Wan Chai
Hong Kong



[11] 2117979.9M001

[15] 10-05-2021

[30] 09-11-2020 / US / 29/757,695

[51] Cl. 14-04

[54] 具有圖形用戶界面的顯示屏

Display screen with graphical user interface

[73] MORGAN, LEWIS & BOCKIUS LLP

1701 Market Street,
Philadelphia, PA 19103,
United States

[74] CHINA PATENT AGENT (HONG KONG) LIMITED

22/F, Great Eagle Centre,
23 Harbour Road,
Wanchai, Hong Kong

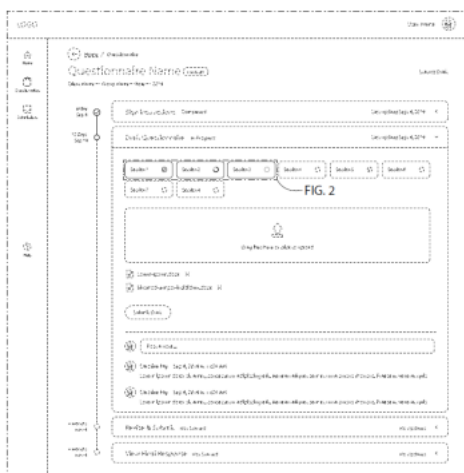

[11] 2117979.9M002

[15] 10-05-2021

[30] 09-11-2020 / US / 29/757,695

[51] Cl. 14-04

[54] 具有圖形用戶界面的顯示屏

Display screen with graphical user interface

[73] MORGAN, LEWIS & BOCKIUS LLP

1701 Market Street,
Philadelphia, PA 19103,
United States

[74] CHINA PATENT AGENT (HONG KONG) LIMITED

22/F, Great Eagle Centre,
23 Harbour Road,
Wanchai, Hong Kong



[11] 2117979.9M003

[15] 10-05-2021

[30] 09-11-2020 / US / 29/757,695

[51] Cl. 14-04

[54] 具有圖形用戶界面的顯示屏

Display screen with graphical user interface

[73] MORGAN, LEWIS & BOCKIUS LLP

1701 Market Street,
Philadelphia, PA 19103,
United States

[74] CHINA PATENT AGENT (HONG KONG) LIMITED

22/F, Great Eagle Centre,
23 Harbour Road,
Wanchai, Hong Kong



[11] 2117979.9M004

[15] 10-05-2021

[30] 09-11-2020 / US / 29/757,695

[51] Cl. 14-04

[54] 具有圖形用戶界面的顯示屏
Display screen with graphical user interface

[73] MORGAN, LEWIS & BOCKIUS LLP
1701 Market Street,
Philadelphia, PA 19103,
United States

[74] CHINA PATENT AGENT (HONG KONG) LIMITED
22/F, Great Eagle Centre,
23 Harbour Road,
Wanchai, Hong Kong

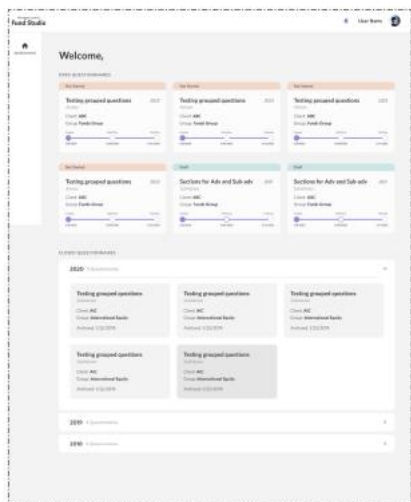

- [11] 2117985.2
[15] 10-05-2021
[30] 09-11-2020 / US / 29/757,773
[51] Cl. 9-03
[54] 包裝盒
Packaging box
[73] 科銳密技術有限責任公司
CREATEME TECHNOLOGIES LLC
54 Howard Street, 3rd Floor,
New York, New York 10013,
United States
[74] SHANGHAI INTELLECTUAL PROPERTY OFFICE
Unit F, 20th Floor, Neich Tower,
128 Gloucester Road,
Hong Kong

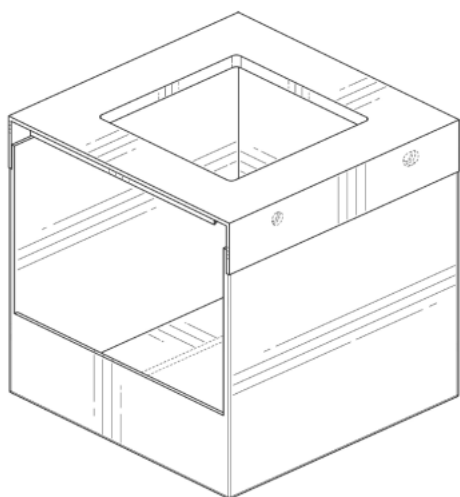

-
- [11] 2117996.5
[15] 12-05-2021
[30] 27-01-2021 / DE / 40 2021 100 061.5
[51] Cl. 12-08
[54] 汽車
Motor vehicle
[73] VOLKSWAGEN AKTIENGESELLSCHAFT
Berliner Ring 2,
38440 Wolfsburg,
Germany
[74] CHINA PATENT AGENT (HONG KONG) LIMITED
22/F, Great Eagle Centre,
23 Harbour Road,
Wanchai, Hong Kong



-
- [11] 2117998.9
[15] 12-05-2021
[30] 27-01-2021 / DE / 40 2021 100 061.5
[51] Cl. 21-01
[54] 玩具車
Toy vehicle
[73] VOLKSWAGEN AKTIENGESELLSCHAFT
Berliner Ring 2,
38440 Wolfsburg,
Germany
[74] CHINA PATENT AGENT (HONG KONG) LIMITED
22/F, Great Eagle Centre,
23 Harbour Road,
Wanchai, Hong Kong



-
- [11] 2118006.8
[15] 14-05-2021
[30] 17-11-2020 / EU / 008270516-0001
[51] Cl. 9-01
[54] 瓶
Flask
[73] GUERLAIN
68 Avenue des Champs-Élysées,
75008 Paris,
France

- [74] WENPING PATENT & TRADE MARK AGENT LIMITED
1701 Tung Wai Commercial Building,
111 Gloucester Road,
Hong Kong

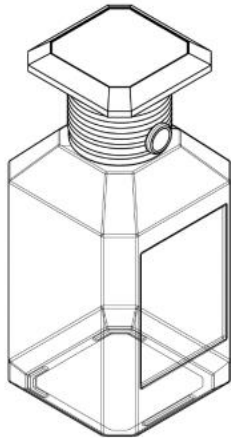

-
- [11] 2118010.6
[15] 14-05-2021
[30] 16-11-2020 / US / 29/758,523
[51] Cl. 2-04
[54] 鞋
Shoe
[73] PELOTON INTERACTIVE, INC.
125 West 25th Street, 11th Floor,
New York, New York 10001,
United States
[74] HNC INNOVATION LIMITED
Units 1205-1208, Cyberport 2,
No. 100 Cyberport Road,
Hong Kong

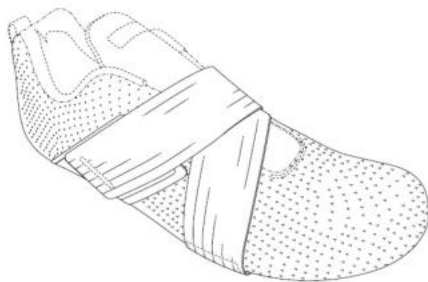

- [11] 2118032.2M001
[15] 18-05-2021
[30] 22-12-2020 / EU / 008360309-0005
[51] Cl. 28-03
[54] 剃鬚器
Shaver
[73] Koninklijke Philips N.V.
High Tech Campus 52,
5656 AG Eindhoven,
Netherlands
[74] Rouse & Co. International (Overseas) Limited
26th Floor, Tesbury Centre
28 Queen's Road East, Wan Chai
Hong Kong



-
- [11] 2118032.2M002
[15] 18-05-2021
[30] 22-12-2020 / EU / 008360309-0014
[51] Cl. 28-03
[54] 剃鬚器手柄
Handle for shaver
[73] Koninklijke Philips N.V.
High Tech Campus 52,
5656 AG Eindhoven,
Netherlands
[74] Rouse & Co. International (Overseas) Limited
26th Floor, Tesbury Centre
28 Queen's Road East, Wan Chai
Hong Kong

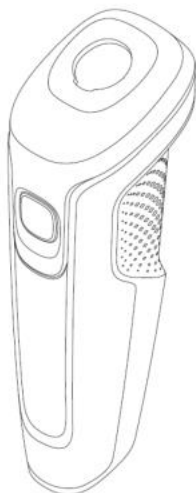

[11] 2118044.7

[15] 21-05-2021

[30] 24-11-2020 / DE / 40 2020 101 097.9

[51] Cl. 12-08

[54] 汽車

Motor vehicle

[73] VOLKSWAGEN AKTIENGESELLSCHAFT

Berliner Ring 2,
38440 Wolfsburg,
Germany

[74] CHINA PATENT AGENT (HONG KONG) LIMITED

22/F, Great Eagle Centre,
23 Harbour Road,
Wanchai, Hong Kong



[11] 2118045.0

[15] 21-05-2021

[30] 24-11-2020 / DE / 40 2020 101 098.7

[51] Cl. 21-01

[54] 玩具車

Toy vehicle

[73] VOLKSWAGEN AKTIENGESELLSCHAFT

Berliner Ring 2,
38440 Wolfsburg,
Germany

[74] CHINA PATENT AGENT (HONG KONG) LIMITED

22/F, Great Eagle Centre,
23 Harbour Road,
Wanchai, Hong Kong



[11] 2118046.2

[15] 21-05-2021

[30] 24-11-2020 / DE / 40 2020 101 098.7

[51] Cl. 12-08

[54] 汽車

Motor vehicle

[73] VOLKSWAGEN AKTIENGESELLSCHAFT

Berliner Ring 2,
38440 Wolfsburg,
Germany

[74] CHINA PATENT AGENT (HONG KONG) LIMITED

22/F, Great Eagle Centre,
23 Harbour Road,
Wanchai, Hong Kong



[11] 2118047.4

[15] 21-05-2021

[30] 24-11-2020 / DE / 40 2020 101 097.9

[51] Cl. 21-01

[54] 玩具車

Toy vehicle

[73] VOLKSWAGEN AKTIENGESELLSCHAFT

Berliner Ring 2,

38440 Wolfsburg,

Germany

[74] CHINA PATENT AGENT (HONG KONG) LIMITED

22/F, Great Eagle Centre,

23 Harbour Road,

Wanchai, Hong Kong



[11] 2118055.1

[15] 24-05-2021

[30] 17-12-2020 / EU / 008329478-0001

[51] Cl. 15-05

[54] 真空吸塵器的吸嘴

Nozzle for vacuum cleaner

[73] Koninklijke Philips N.V.

High Tech Campus 52,

5656 AG Eindhoven,

Netherlands

[74] Rouse & Co. International (Overseas) Limited

26th Floor, Tesbury Centre

28 Queen's Road East, Wan Chai

Hong Kong

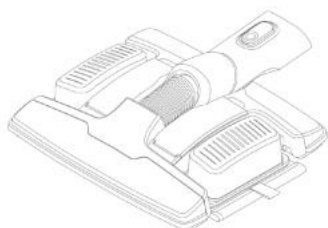

- [11] 2118063.7
[15] 25-05-2021
[30] 10-12-2020 / FR / 2020-5619
[51] Cl. 3-01
[54] 袋
Bag
[73] LOUIS VUITTON MALLETIER
2 rue du Pont-Neuf,
75001 Paris,
France
[74] BAKER & MCKENZIE
14th Floor, One Taikoo Place,
979 King's Road,
Quarry Bay, Hong Kong



-
- [11] 2118068.8M001
[15] 26-05-2021
[30] 10-12-2020 / EU / 008315162-0002
[51] Cl. 28-03
[54] 修剪器
Clipper
[73] Koninklijke Philips N.V.
High Tech Campus 52,
5656 AG Eindhoven,
Netherlands
[74] Rouse & Co. International (Overseas) Limited
26th Floor, Tesbury Centre
28 Queen's Road East, Wan Chai
Hong Kong



[11] 2118068.8M002

[15] 26-05-2021

[30] 10-12-2020 / EU / 008315162-0007

[51] Cl. 28-03

[54] 修剪器附件

Attachment for clipper

[73] Koninklijke Philips N.V.

High Tech Campus 52,

5656 AG Eindhoven,

Netherlands

[74] Rouse & Co. International (Overseas) Limited

26th Floor, Tesbury Centre

28 Queen's Road East, Wan Chai

Hong Kong

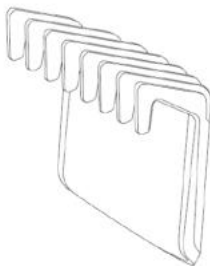

[11] 2118096.7

[15] 02-06-2021

[30] 08-03-2021 / CN / 202130123135.8

[51] Cl. 9-01

[54] 竹節形瓶

Bamboo joint shaped bottle

[73] 北京同仁堂國藥有限公司

BEIJING TONG REN TANG CHINESE MEDICINE COMPANY LIMITED

香港

新界大埔

工業邨大景街 3 號

[74] 中港知識產權有限公司

香港

灣仔告士打道 151 號

資本中心 15 樓 1502 室

HONG KONG



[11] 2118135.1

[15] 09-06-2021

[30] 26-03-2021 / JP / 006374 of 2021

[51] Cl. 9-07

[54] 包裝用容器的蓋

Cap for packaging container

[73] 日清食品株式會社

NISSIN FOOD PRODUCTS CO., LTD.

1-1, Nishinakajima 4 chome,

Yodogawa-ku, Osaka-shi, Osaka 5328524,

Japan

[74] MARKS & CLERK

Level 9, Cyberport 1,

100 Cyberport Road,

Pok Fu Lam, Hong Kong

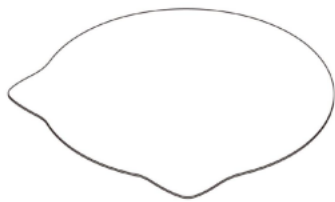

[11] 2118137.5M001

[15] 09-06-2021

[30] 11-12-2020 / JP / 026674 of 2020

[51] Cl. 19-06

[54] 塗抹筆

Applicator pen

[73] Pentel Kabushiki Kaisha

7-2, Nihonbashi Koami-cho,

Chuo-ku, Tokyo,

Japan

[74] EMILY YIP & CO LIMITED

1st Floor, Kingsfield Centre,

18 Shell Street,

Fortress Hill, Hong Kong

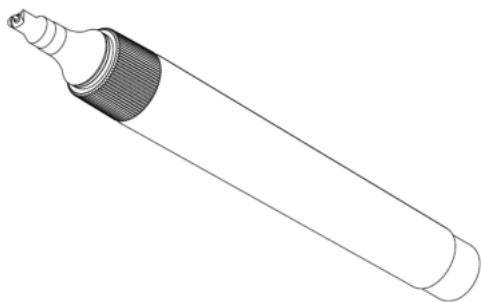

[11] 2118137.5M002

[15] 09-06-2021

[30] 11-12-2020 / JP / 026675 of 2020

[51] Cl. 19-06

[54] 塗抹筆

Applicator pen

[73] Pentel Kabushiki Kaisha

7-2, Nihonbashi Koami-cho,

Chuo-ku, Tokyo,
Japan

- [74] EMILY YIP & CO LIMITED
1st Floor, Kingsfield Centre,
18 Shell Street,
Fortress Hill, Hong Kong

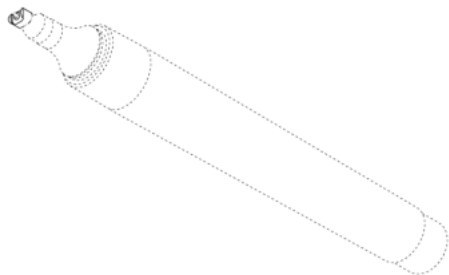

[11] 2118144.9

[15] 10-06-2021

[51] Cl. 6-01

[54] 安樂椅

Club chair

[73] DEDON GmbH

Zeppelinstrasse 22,

21337 Lüneburg,

Germany

[74] Angela Wang & Co

14th Floor, South China Building,

1-3 Wyndham Street,

Central, Hong Kong



[11] 2118145.2

[15] 10-06-2021

[51] Cl. 6-01

[54] 沙發

Sofa

[73] DEDON GmbH

Zeppelinstrasse 22,

21337 Lüneburg,

Germany

[74] Angela Wang & Co

14th Floor, South China Building,

1-3 Wyndham Street,

Central, Hong Kong

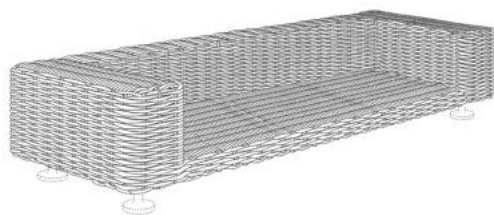

[11] 2118146.4

[15] 10-06-2021

[51] Cl. 6-01

[54] 扶手椅

Armchair

[73] DEDON GmbH

Zeppelinstrasse 22,

21337 Lüneburg,

Germany

[74] Angela Wang & Co

14th Floor, South China Building,

1-3 Wyndham Street,

Central, Hong Kong



[11] 2118164.1M001

[15] 15-06-2021

[30] 15-12-2020 / EU / 008322408-0013

[51] Cl. 28-03

[54] 剃鬚器手柄

Handle for shaver

[73] Koninklijke Philips N.V.

High Tech Campus 52,

5656 AG Eindhoven,

Netherlands

[74] Rouse & Co. International (Overseas) Limited

26th Floor, Tesbury Centre

28 Queen's Road East, Wan Chai

Hong Kong



[11] 2118164.1M002

[15] 15-06-2021

[30] 15-12-2020 / EU / 008322408-0014

[51] Cl. 28-03

[54] 剃鬚器手柄

Handle for shaver

[73] Koninklijke Philips N.V.

High Tech Campus 52,

5656 AG Eindhoven,

Netherlands

[74] Rouse & Co. International (Overseas) Limited

26th Floor, Tesbury Centre

28 Queen's Road East, Wan Chai

Hong Kong



[11] 2118164.1M003

[15] 15-06-2021

[30] 15-12-2020 / EU / 008322408-0023

[51] Cl. 28-03

[54] 剃鬚器

Shaver

[73] Koninklijke Philips N.V.

High Tech Campus 52,

5656 AG Eindhoven,

Netherlands

[74] Rouse & Co. International (Overseas) Limited

26th Floor, Tesbury Centre

28 Queen's Road East, Wan Chai

Hong Kong



[11] 2118164.1M004

[15] 15-06-2021

[30] 15-12-2020 / EU / 008322408-0026

[51] Cl. 28-03

[54] 剃鬚器
Shaver

[73] Koninklijke Philips N.V.
High Tech Campus 52,
5656 AG Eindhoven,
Netherlands

[74] Rouse & Co. International (Overseas) Limited
26th Floor, Tesbury Centre
28 Queen's Road East, Wan Chai
Hong Kong



[11] 2118164.1M005

[15] 15-06-2021

[30] 15-12-2020 / EU / 008322408-0027

[51] Cl. 28-03

[54] 剃鬚器手柄

Handle for shaver

[73] Koninklijke Philips N.V.

High Tech Campus 52,

5656 AG Eindhoven,

Netherlands

[74] Rouse & Co. International (Overseas) Limited

26th Floor, Tesbury Centre

28 Queen's Road East, Wan Chai

Hong Kong



[11] 2118164.1M006

[15] 15-06-2021

[30] 15-12-2020 / EU / 008322408-0028

[51] Cl. 28-03

[54] 剃鬚器手柄

Handle for shaver

[73] Koninklijke Philips N.V.

High Tech Campus 52,

5656 AG Eindhoven,

Netherlands

[74] Rouse & Co. International (Overseas) Limited

26th Floor, Tesbury Centre

28 Queen's Road East, Wan Chai

Hong Kong



[11] 2118164.1M007

[15] 15-06-2021

[30] 15-12-2020 / EU / 008322408-0042

[51] Cl. 28-03

[54] 剃鬚器手柄

Handle for shaver

[73] Koninklijke Philips N.V.

High Tech Campus 52,

5656 AG Eindhoven,

Netherlands

[74] Rouse & Co. International (Overseas) Limited

26th Floor, Tesbury Centre

28 Queen's Road East, Wan Chai

Hong Kong

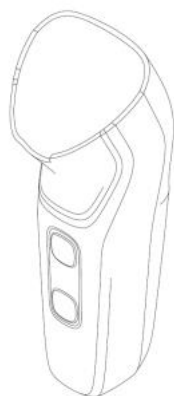

[11] 2118164.1M008

[15] 15-06-2021

[30] 15-12-2020 / EU / 008322408-0043

[51] Cl. 28-03

[54] 剃鬚刀刀頭

Head for shaver

[73] Koninklijke Philips N.V.

High Tech Campus 52,

5656 AG Eindhoven,

Netherlands

[74] Rouse & Co. International (Overseas) Limited

26th Floor, Tesbury Centre

28 Queen's Road East, Wan Chai

Hong Kong



[11] 2118164.1M009

[15] 15-06-2021

[30] 15-12-2020 / EU / 008322408-0047

[51] Cl. 28-03

[54] 剃鬚刀刀頭

Head for shaver

[73] Koninklijke Philips N.V.

High Tech Campus 52,

5656 AG Eindhoven,

Netherlands

[74] Rouse & Co. International (Overseas) Limited

26th Floor, Tesbury Centre

28 Queen's Road East, Wan Chai

Hong Kong



[11] 2118164.1M010

[15] 15-06-2021

[30] 15-12-2020 / EU / 008322408-0048

[51] Cl. 28-03

[54] 剃鬚刀刀頭

Head for shaver

[73] Koninklijke Philips N.V.

High Tech Campus 52,

5656 AG Eindhoven,

Netherlands

[74] Rouse & Co. International (Overseas) Limited

26th Floor, Tesbury Centre

28 Queen's Road East, Wan Chai

Hong Kong



[11] 2118164.1M011

[15] 15-06-2021

[30] 15-12-2020 / EU / 008322408-0068

[51] Cl. 28-03

[54] 剃鬚器

Shaver

- [73] Koninklijke Philips N.V.
High Tech Campus 52,
5656 AG Eindhoven,
Netherlands
- [74] Rouse & Co. International (Overseas) Limited
26th Floor, Tesbury Centre
28 Queen's Road East, Wan Chai
Hong Kong



-
- [11] 2118164.1M012
- [15] 15-06-2021
- [30] 15-12-2020 / EU / 008322408-0075
- [51] Cl. 28-03
- [54] 剃鬚器
Shaver
- [73] Koninklijke Philips N.V.
High Tech Campus 52,
5656 AG Eindhoven,
Netherlands
- [74] Rouse & Co. International (Overseas) Limited
26th Floor, Tesbury Centre
28 Queen's Road East, Wan Chai
Hong Kong



[11] 2118164.1M013

[15] 15-06-2021

[30] 15-12-2020 / EU / 008322408-0077

[51] Cl. 28-03

[54] 剃鬚器
Shaver

[73] Koninklijke Philips N.V.
High Tech Campus 52,
5656 AG Eindhoven,
Netherlands

[74] Rouse & Co. International (Overseas) Limited
26th Floor, Tesbury Centre
28 Queen's Road East, Wan Chai
Hong Kong



- [11] 2118164.1M014
[15] 15-06-2021
[30] 15-12-2020 / EU / 008322408-0079
[51] Cl. 28-03
[54] 剃鬚器
Shaver
[73] Koninklijke Philips N.V.
High Tech Campus 52,
5656 AG Eindhoven,
Netherlands
[74] Rouse & Co. International (Overseas) Limited
26th Floor, Tesbury Centre
28 Queen's Road East, Wan Chai
Hong Kong



-
- [11] 2118164.1M015
[15] 15-06-2021
[30] 15-12-2020 / EU / 008322408-0080
[51] Cl. 28-03
[54] 剃鬚器
Shaver
[73] Koninklijke Philips N.V.
High Tech Campus 52,
5656 AG Eindhoven,
Netherlands
[74] Rouse & Co. International (Overseas) Limited
26th Floor, Tesbury Centre
28 Queen's Road East, Wan Chai
Hong Kong





香港特別行政區政府知識產權署外觀設計註冊處

The Government of the Hong Kong Special Administrative Region

Designs Registry, Intellectual Property Department

根據註冊外觀設計條例第 28 條，下列註冊外觀設計因未繳續期費而停止有效。

各組記項按註冊外觀設計停止有效日期及註冊編號先後次序排列。

Registered designs ceased through non-payment of renewal fees under section 28 of the Registered Designs Ordinance. Entries are listed below under their expiry dates.

15-07-2021 - 20-07-2021**15-07-2021**

1101212.3M001

1101212.3M002

16-07-2021

0601865.1

0601869.9

0601871.3

17-07-2021

1101219.8

1101220.0

1601379.1M001

1601379.1M002

1601380.3M001

1601380.3M002

1601381.5M001

1601382.7

1601387.8

18-07-2021

1101221.2

1101222.4

1601388.0

19-07-2021

1601390.4M001

1601390.4M002

1601393.0

1601394.2

1601395.5M001

1601395.5M002

1601395.5M003

1601395.5M004

1601395.5M005

20-07-2021

0601908.3

0601909.5

0601910.7

1101233.7

1101234.9

1601400.7

1601401.9

1601403.3M001

1601406.0



香港特別行政區政府知識產權署外觀設計註冊處

The Government of the Hong Kong Special Administrative Region

Designs Registry, Intellectual Property Department

根據註冊外觀設計規則第 31 條刪除的註冊外觀設計。各組記項按註冊外觀設計刪除日期及註冊編號先後次序排列。

Registered designs removed under section 31 of the Registered Designs Rules. Entries are listed below under their removal dates.

11-09-2021 - 15-09-2021

11-09-2021	1600093.3M002	0600168.1M001
1100080.1	1600094.5M001	0600168.1M002
	1600094.5M002	0600168.1M003
12-09-2021	1600094.5M003	0600168.1M004
0110098.9	1600094.5M004	0600168.1M005
	1600095.8M001	0600168.1M006
13-09-2021	1600095.8M002	0600168.1M007
0600130.1	1600095.8M003	0600168.1M008
0600134.9	1600095.8M004	0600168.1M009
0600135.2	1600095.8M005	0600168.1M010
0600137.6M001	1600095.8M006	1100106.8
0600137.6M002	1600095.8M007	1100107.0
1100092.6	1600095.8M008	1100108.2
1600072.9M001	1600095.8M009	
1600072.9M002	1600095.8M010	
1600075.6	1600095.8M011	
1600076.8M001	1600095.8M012	
1600076.8M002	1600095.8M013	
1600078.2	1600095.8M014	
1600079.4	1600095.8M015	
1600080.6	1600095.8M016	
1600081.8	1600095.8M017	
1600082.0	1600095.8M018	
1600086.9	1600096.0	
	1600097.2	
14-09-2021	1600098.4	
0600152.7	1600099.6	
1600087.1	1600100.0	
1600088.3	1600101.2	
1600089.5	1600102.4	
1600090.7	1600103.6	
1600091.9	1600104.8	
1600092.1		
1600093.3M001	15-09-2021	



香港特別行政區政府知識產權署外觀設計註冊處
The Government of the Hong Kong Special Administrative Region
Designs Registry, Intellectual Property Department

勘誤

CORRIGENDUM

已在官方公報刊登的外觀設計公告內的日期更正如下：

The following show the corrected date previously published in the official journal:

官方公報日期 Official journal date 10.09.2021

[11] 2016581.3M002

The following request for correction of error advertised in the official journal on 21.05.2021 was allowed on 22.07.2021