

香港知識產權公報

Hong Kong Intellectual Property Journal

2020年10月30日
30 October 2020

目錄 Contents

根據註冊外觀設計條例第 25 條註冊的外觀設計

Designs Registered under section 25 of the Registered Designs Ordinance

按註冊編號排列

Arranged by Registration Number

根據註冊外觀設計條例(第 522 章)公布的其他公告

Other Notices Published under the Registered Designs Ordinance (Cap. 522)

根據註冊外觀設計條例第 28 條，註冊外觀設計因未繳續期費而停止有效

Registered designs ceased through non-payment of renewal fees under section 28 of the Registered Designs Ordinance

根據註冊外觀設計規則第 31 條刪除的註冊外觀設計

Registered designs removed under section 31 of the Registered Designs Rules

勘誤

Corrigendum

以下事項沒有記錄

No Records for the Following Matters

根據註冊外觀設計條例第 30 條放棄的外觀設計的註冊

Surrender of Registration of Design under section 30 of the Registered Designs Ordinance

根據註冊外觀設計規則第 37 條，向處長作出轉介

Reference to Registrar under section 37 of the Registered Designs Rules

根據註冊外觀設計條例第 45 條，撤銷註冊

Revocation of Registration under section 45 of the Registered Designs Ordinance

根據註冊外觀設計規則第 46 條，向法院作出轉介

Reference to Court under section 46 of the Registered Designs Rules

根據註冊外觀設計規則第 63 條對不符合規定之處作出糾正

Rectification of Irregularities under section 63 of the Registered Designs Rules

根據註冊外觀設計條例第 66 條，糾正註冊紀錄冊

Rectification of Register under section 66 of the Registered Designs Ordinance

根據註冊外觀設計條例第 67 條 更正註冊紀錄冊內的錯誤

Correction of errors in Register under section 67 of the Registered Designs Ordinance

根據註冊外觀設計條例第 67 及 76 條，更正註冊紀錄冊內及已提交文件中的錯誤

Correction of Errors in Register and in Filed Documents under sections 67 and 76 of the Registered Designs Ordinance

根據註冊外觀設計條例第 76 條，更正已提交文件中的錯誤

Correction of errors in filed documents under section 76 of the Registered Designs Ordinance

註冊外觀設計公告註釋

Notes on advertisements of registration of designs

方括號表示下列資料：

Square brackets indicate the following data：

[11] 註冊編號 Registration number / 聯合王國註冊編號 United Kingdom registration number

[15] 註冊日期 Registration date / 當作註冊日期 Deemed registration date / 聯合王國註冊日期 United Kingdom registration date

[17] 註冊有效期屆滿日期 Expiry date of the period of registration

[22] 提交日期 Filing date / 當作提交日期 Deemed filing date / 聯合王國提交日期 United Kingdom filing date

[30] 聲稱享有的優先權（提交日期 / 巴黎公約國或世界貿易組織成員 / 申請編號） Priority claimed (filing date / Paris Convention country or WTO member / application number)

[51] 國際外觀設計分類號（洛迦諾分類號） International Classification of designs (Locarno Classification)

[54] 物品 Article

[55] 外觀設計的表述 Representation of the design

[62] 分開前的申請編號及提交日期 Application number before division and filing date

[66] 過往註冊的聯繫外觀設計註冊編號 / 日期 Registration No. / Date of Previous Registration for Association

[72] 設計人 Designer

[73] 擁有人姓名和地址 Name and address of the owner

[74] 代理人 Agent / 送達地址 Address for service



香港特別行政區政府知識產權署外觀設計註冊處

The Government of the Hong Kong Special Administrative Region

Designs Registry, Intellectual Property Department

根據註冊外觀設計條例第 25 條註冊的外觀設計

Designs registered under section 25 of the Registered Designs Ordinance

按註冊編號排列

Arranged by Registration Number

[11] 1802162.4M001

[15] 02-11-2018

[30] 14-08-2018 / CN / 201830448106.7

[51] Cl. 10-05

[54] 一體化自助服務亭

All-in-one self-service kiosk

[73] K11 Group Limited

10/F, Inter-Continental Plaza,
94 Granville Road, Tsim Sha Tsui,
Kowloon, Hong Kong

[74] Eagle IP Limited

Room 508-509, Global Gateway Tower,
63 Wing Hong Street, Lai Chi Kok,
Hong Kong.

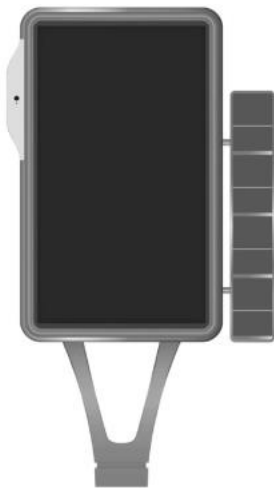

[11] 1802162.4M002

[15] 02-11-2018

[30] 14-08-2018 / CN / 201830448106.7

[51] Cl. 10-05

[54] 一體化自助服務亭

All-in-one self-service kiosk

[73] K11 Group Limited

10/F, Inter-Continental Plaza,
94 Granville Road, Tsim Sha Tsui,
Kowloon, Hong Kong

[74] Eagle IP Limited

Room 508-509, Global Gateway Tower,
63 Wing Hong Street, Lai Chi Kok,
Hong Kong.



[11] 1802213.3

[15] 12-11-2018

[30] 06-11-2018 / CN / 201830624349.1

[51] Cl. 9-03

[54] 罐子

Container

[73] 深圳市禾意創智科技有限公司

Shenzhen Horizone Technology Co., Ltd.
Room 201, Building A, No. 1, Qianwan 1st Road,
Qianhai Shenzhen-Hong Kong Cooperation Zone,
Nanshan District, Shenzhen, CHINA

[74] CHINAHONGKONG IP LIMITED

3011, 30/F, Office Tower,
Convention Plaza, 1 Harbour Road,
Hong Kong.



[11] 1802500.3M001

[15] 20-12-2018

[30] 02-07-2018 / EU / 005349503

[51] Cl. 7-01

[54] 飲用杯蓋

Lid for drinking cups

[73] HUHTAMÄKI OYJ

REVONTULENKUJA 1,

02100 ESPOO,

FINLAND

[74] China Patent Agent (H.K.) Ltd.

22/F, Great Eagle Centre,

23 Harbour Road, Wanchai,

Hong Kong



[11] 1802500.3M002

[15] 20-12-2018

[30] 02-07-2018 / EU / 005349503

[51] Cl. 7-01

[54] 飲用杯蓋

Lid for drinking cups

[73] HUHTAMÄKI OYJ
REVONTULENKUJA 1,
02100 ESPOO,
FINLAND

[74] China Patent Agent (H.K.) Ltd.
22/F, Great Eagle Centre,
23 Harbour Road, Wanchai,
Hong Kong



[11] 1914320.5M001

[15] 25-07-2019

[30] 25-01-2019 / US / 29/678,094

[51] Cl. 28-03

[54] 皮膚按摩器
Skin massager

[73] Filip Sedic
Room 1711-1720
75 South Wanping Road, Shanghai 200032,
CHINA

[74] UNITALEN ATTORNEYS AT LAW LIMITED
RM 1201, 12/F,
GOLDEN ERA PLAZA,
39-55 SAI YEE ST, MONGKOK KLN
HONG KONG

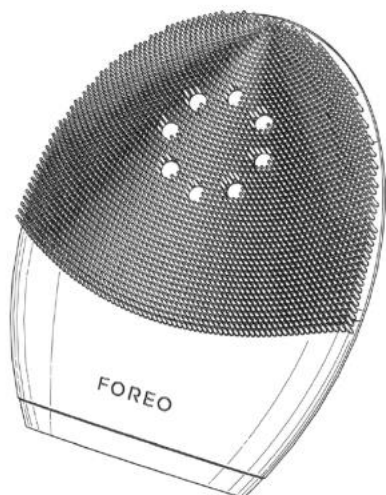

[11] 1914320.5M002

[15] 25-07-2019

[30] 25-01-2019 / US / 29/678,094

[51] Cl. 28-03

[54] 皮膚按摩器

Skin massager

[73] Filip Sedic

Room 1711-1720

75 South Wanping Road, Shanghai 200032,
CHINA

[74] UNITALEN ATTORNEYS AT LAW LIMITED

RM 1201, 12/F,

GOLDEN ERA PLAZA,

39-55 SAI YEE ST, MONGKOK KLN

HONG KONG

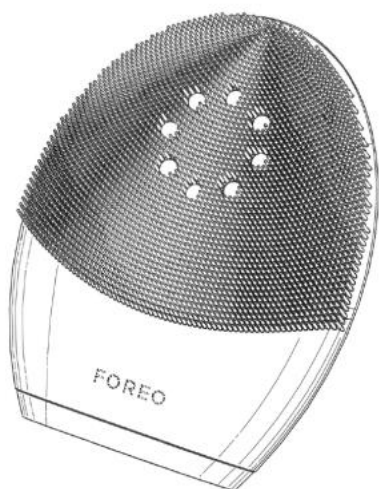

- [11] 1914320.5M003
[15] 25-07-2019
[30] 25-01-2019 / US / 29/678,094
[51] Cl. 28-03
[54] 皮膚按摩器
Skin massager
[73] Filip Sedic
Room 1711-1720
75 South Wanping Road, Shanghai 200032,
CHINA
[74] UNITALEN ATTORNEYS AT LAW LIMITED
RM 1201, 12/F,
GOLDEN ERA PLAZA,
39-55 SAI YEE ST, MONGKOK KLN
HONG KONG

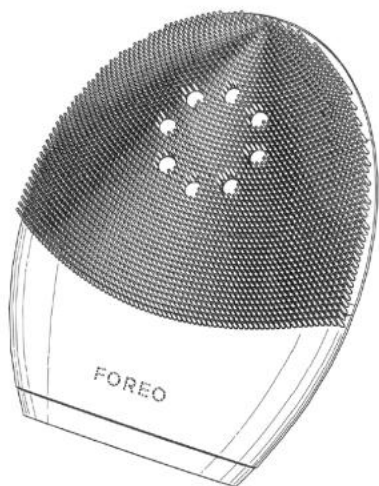

-
- [11] 1914320.5M004
[15] 25-07-2019
[30] 25-01-2019 / US / 29/678,094
[51] Cl. 28-03
[54] 皮膚按摩器
Skin massager
[73] Filip Sedic
Room 1711-1720
75 South Wanping Road, Shanghai 200032,
CHINA
[74] UNITALEN ATTORNEYS AT LAW LIMITED
RM 1201, 12/F,
GOLDEN ERA PLAZA,

39-55 SAI YEE ST, MONGKOK KLN
HONG KONG

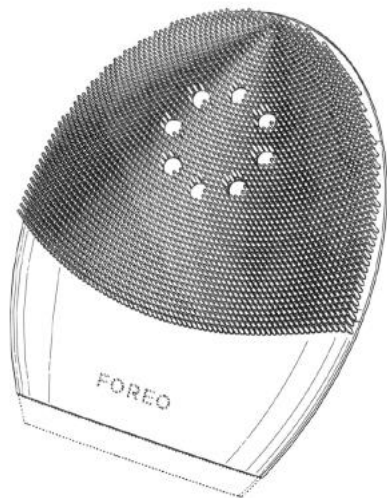

[11] 1914320.5M005

[15] 25-07-2019

[30] 25-01-2019 / US / 29/678,094

[51] Cl. 28-03

[54] 皮膚按摩器

Skin massager

[73] Filip Sedic

Room 1711-1720

75 South Wanping Road, Shanghai 200032,

CHINA

[74] UNITALEN ATTORNEYS AT LAW LIMITED

RM 1201, 12/F,

GOLDEN ERA PLAZA,

39-55 SAI YEE ST, MONGKOK KLN

HONG KONG

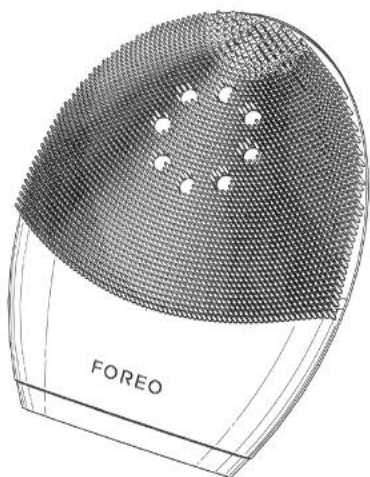

[11] 1914320.5M006

[15] 25-07-2019

[30] 25-01-2019 / US / 29/678,094

[51] Cl. 28-03

[54] 皮膚按摩器

Skin massager

[73] Filip Sedic

Room 1711-1720

75 South Wanping Road, Shanghai 200032,
CHINA

[74] UNITALEN ATTORNEYS AT LAW LIMITED

RM 1201, 12/F,

GOLDEN ERA PLAZA,

39-55 SAI YEE ST, MONGKOK KLN

HONG KONG

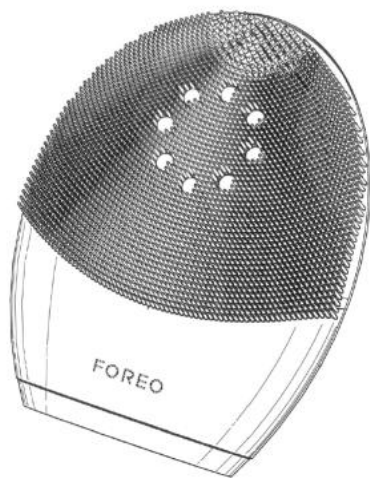

- [11] 1914320.5M007
[15] 25-07-2019
[30] 25-01-2019 / US / 29/678,094
[51] Cl. 28-03
[54] 皮膚按摩器
Skin massager
[73] Filip Sedic
Room 1711-1720
75 South Wanping Road, Shanghai 200032,
CHINA
[74] UNITALEN ATTORNEYS AT LAW LIMITED
RM 1201, 12/F,
GOLDEN ERA PLAZA,
39-55 SAI YEE ST, MONGKOK KLN
HONG KONG

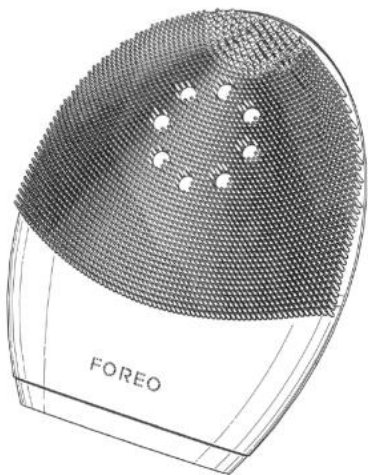

-
- [11] 1914320.5M008
[15] 25-07-2019
[30] 25-01-2019 / US / 29/678,094
[51] Cl. 28-03
[54] 皮膚按摩器
Skin massager
[73] Filip Sedic
Room 1711-1720
75 South Wanping Road, Shanghai 200032,
CHINA
[74] UNITALEN ATTORNEYS AT LAW LIMITED
RM 1201, 12/F,
GOLDEN ERA PLAZA,

39-55 SAI YEE ST, MONGKOK KLN
HONG KONG



[11] 1914320.5M009

[15] 25-07-2019

[30] 25-01-2019 / US / 29/678,094

[51] Cl. 28-03

[54] 皮膚按摩器

Skin massager

[73] Filip Sedic

Room 1711-1720

75 South Wanping Road, Shanghai 200032,

CHINA

[74] UNITALEN ATTORNEYS AT LAW LIMITED

RM 1201, 12/F,

GOLDEN ERA PLAZA,

39-55 SAI YEE ST, MONGKOK KLN

HONG KONG

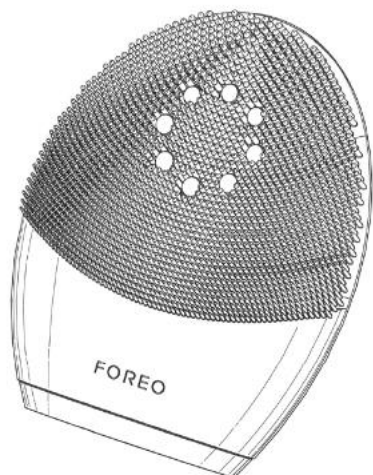

[11] 1914320.5M010

[15] 25-07-2019

[30] 25-01-2019 / US / 29/678,094

[51] Cl. 28-03

[54] 皮膚按摩器

Skin massager

[73] Filip Sedic

Room 1711-1720

75 South Wanping Road, Shanghai 200032,
CHINA

[74] UNITALEN ATTORNEYS AT LAW LIMITED

RM 1201, 12/F,

GOLDEN ERA PLAZA,

39-55 SAI YEE ST, MONGKOK KLN

HONG KONG

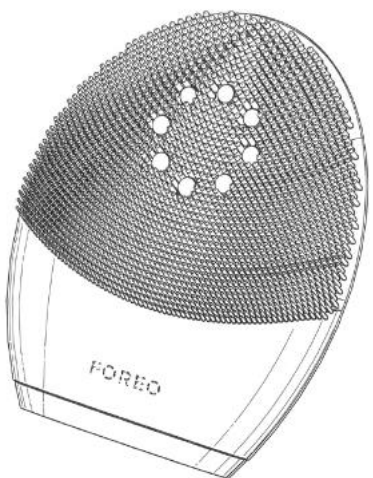

- [11] 1914320.5M011
[15] 25-07-2019
[30] 25-01-2019 / US / 29/678,094
[51] Cl. 28-03
[54] 皮膚按摩器
Skin massager
[73] Filip Sedic
Room 1711-1720
75 South Wanping Road, Shanghai 200032,
CHINA
[74] UNITALEN ATTORNEYS AT LAW LIMITED
RM 1201, 12/F,
GOLDEN ERA PLAZA,
39-55 SAI YEE ST, MONGKOK KLN
HONG KONG

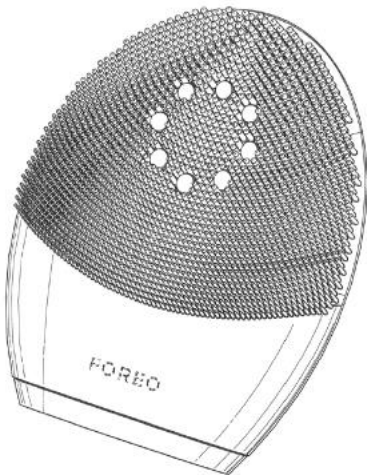

-
- [11] 1914320.5M012
[15] 25-07-2019
[30] 25-01-2019 / US / 29/678,094
[51] Cl. 28-03
[54] 皮膚按摩器
Skin massager
[73] Filip Sedic
Room 1711-1720
75 South Wanping Road, Shanghai 200032,
CHINA
[74] UNITALEN ATTORNEYS AT LAW LIMITED
RM 1201, 12/F,
GOLDEN ERA PLAZA,

39-55 SAI YEE ST, MONGKOK KLN
HONG KONG

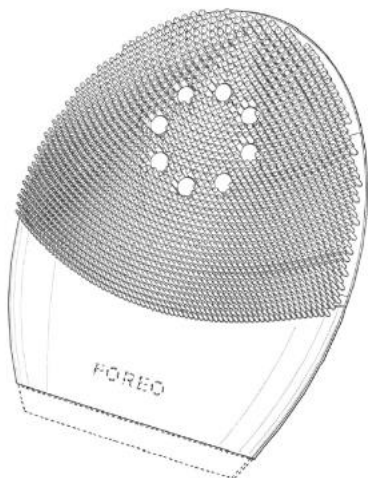

[11] 2015823.6

[15] 20-03-2020

[51] Cl. 9-03

[54] 食品容器部件

Component for a food container

[73] 祖美股份有限公司

ZUME, Inc.

250 Polaris Avenue Mountain View, California

94043 UNITED STATES OF AMERICA

[74] CHINAHONGKONG IP LIMITED

3011, 30/F, Office Tower, Convention Plaza,

1 Harbour Road,

Hong Kong



[11] 2015847.7

[15] 24-03-2020

[51] Cl. 3-01

[54] 袋
Bag

[73] LOUIS VUITTON MALLETIER
2 rue du Pont-Neuf,
75001 Paris,
FRANCE

[74] BAKER & MCKENZIE
14th Floor, One Taikoo Place,
979 King's Road,
Quarry Bay, Hong Kong



[11] 2015849.1

[15] 24-03-2020

[51] Cl. 3-01

[54] 袋
Bag

[73] LOUIS VUITTON MALLETIER
2 rue du Pont-Neuf,
75001 Paris,
FRANCE

[74] BAKER & MCKENZIE
14th Floor, One Taikoo Place,
979 King's Road,
Quarry Bay, Hong Kong

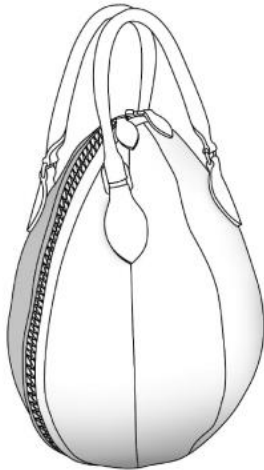

[11] 2015931.5M001

[15] 07-04-2020

[30] 07-10-2019 / DE / 40 2019 101 092.0

[51] Cl. 21-01

[54] 玩具或比例模型車

Toy or scale model vehicle

[73] Bayerische Motoren Werke Aktiengesellschaft

Petuelring 130,

80809 Muenchen,

GERMANY

[74] HASTINGS & CO

5/F Gloucester Tower, The Landmark,

11 Pedder Street,

Central, Hong Kong



[11] 2015931.5M002

[15] 07-04-2020

[30] 07-10-2019 / DE / 40 2019 101 092.0

[51] Cl. 21-01

- [54] 玩具或比例模型車
Toy or scale model vehicle
- [73] Bayerische Motoren Werke Aktiengesellschaft
Petuelring 130,
80809 Muenchen,
GERMANY
- [74] HASTINGS & CO
5/F Gloucester Tower, The Landmark,
11 Pedder Street,
Central, Hong Kong



-
- [11] 2016030.5
- [15] 22-04-2020
- [51] Cl. 13-04
- [54] 物理式防水太陽能板支架
Physical waterproof solar panel support
- [73] 綽能光伏有限公司
SOLAREGEN LTD
香港
青山公路葵涌段 303 號
IPLACE 2118 室
- [74] 綽能光伏有限公司
香港
青山公路葵涌段 303 號
IPLACE 2118 室



[11] 2016037.0

[15] 23-04-2020

[30] 25-10-2019 / DE / 40 2019 101 152.8

[51] Cl. 21-01

[54] 玩具汽車

Toy vehicle

[73] VOLKSWAGEN AKTIENGESELLSCHAFT

BERLINER RING 2,

38440 WOLFSBURG,

GERMANY

[74] CHINA PATENT AGENT (HONG KONG) LIMITED

22/F, Great Eagle Centre,

23 Harbour Road,

Wanchai, Hong Kong



[11] 2016038.2M001

[15] 23-04-2020

[30] 25-10-2019 / DE / 40 2019 101 152.8

[51] Cl. 12-08

[54] 汽車

Motor vehicle

[73] VOLKSWAGEN AKTIENGESELLSCHAFT

BERLINER RING 2,

38440 WOLFSBURG,

GERMANY

[74] CHINA PATENT AGENT (HONG KONG) LIMITED

22/F, Great Eagle Centre,

23 Harbour Road,

Wanchai, Hong Kong



[11] 2016038.2M002

[15] 23-04-2020

[30] 25-10-2019 / DE / 40 2019 101 152.8

[51] Cl. 12-08

[54] 汽車

Motor vehicle

[73] VOLKSWAGEN AKTIENGESELLSCHAFT

BERLINER RING 2,

38440 WOLFSBURG,

GERMANY

[74] CHINA PATENT AGENT (HONG KONG) LIMITED

22/F, Great Eagle Centre,

23 Harbour Road,

Wanchai, Hong Kong



[11] 2016038.2M003

[15] 23-04-2020

[30] 25-10-2019 / DE / 40 2019 101 152.8

[51] Cl. 12-08

[54] 汽車

Motor vehicle

[73] VOLKSWAGEN AKTIENGESELLSCHAFT

BERLINER RING 2,

38440 WOLFSBURG,
GERMANY

[74] CHINA PATENT AGENT (HONG KONG) LIMITED
22/F, Great Eagle Centre,
23 Harbour Road,
Wanchai, Hong Kong



[11] 2016062.2

[15] 27-04-2020

[51] Cl. 30-08

[54] 家禽腳圈
Poultry leg ring

[73] 香港科朗現代農業有限公司
Hong Kong Kelang Modern Agriculture Co., Ltd
香港新界
元朗錦田
大江埔 195A 號

[74] 香港科朗現代農業有限公司
香港九龍
長沙灣長裕街 12 號
經達廣場 13 樓 06 室



- [11] 2016072.3
[15] 28-04-2020
[51] Cl. 29-02
[54] 掛耳式口罩連雙重調節扣
Ear loop face mask with double adjustable knot
[73] 余智偉
YU CHI WAI PHILIP
香港九龍
荔枝角長沙灣道 760-762 號
香港紗廠工業大廈第五期 2 樓 C1 室
[74] 余智偉
香港九龍
荔枝角長沙灣道 760-762 號
香港紗廠工業大廈第五期 2 樓 C1 室

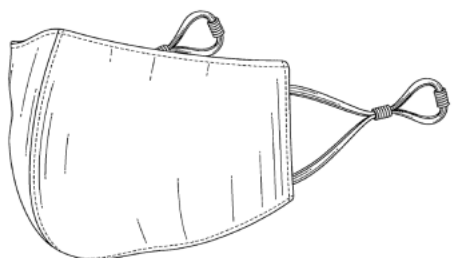

-
- [11] 2016088.7
[15] 30-04-2020
[30] 06-11-2019 / CN / 201930608098.2
[51] Cl. 10-07
[54] 控制盒外殼
Housing of control box
[73] 上海商湯智能科技有限公司
中國內地
上海市徐匯區桂平路 391 號
3 號樓 1605A 室
[74] 香港派特恩知識產權代理有限公司
香港上環
永樂街 121-125 號
永達商業大廈 10 樓 C 室

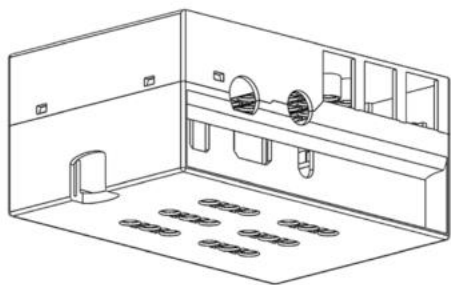

[11] 2016173.7M001

[15] 20-05-2020

[30] 09-01-2020 / US / 29/720,064

[51] Cl. 22-01

[54] 槍支的把手

Hand grip for gun

[73] SMITH & WESSON INC.

2100 Roosevelt Avenue,
Springfield, MA 01104,
United States

[74] CHINA PATENT AGENT (HONG KONG) LIMITED

22/F, Great Eagle Centre,
23 Harbour Road,
Wanchai. Hong Kong

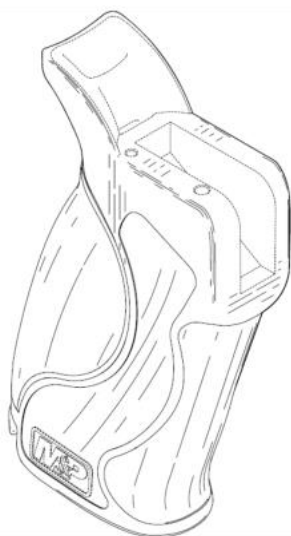

[11] 2016173.7M002

[15] 20-05-2020

[30] 09-01-2020 / US / 29/720,064

[51] Cl. 22-01

[54] 槍支的把手

Hand grip for gun

[73] SMITH & WESSON INC.

2100 Roosevelt Avenue,
Springfield, MA 01104,
United States

[74] CHINA PATENT AGENT (HONG KONG) LIMITED

22/F, Great Eagle Centre,
23 Harbour Road,
Wanchai. Hong Kong

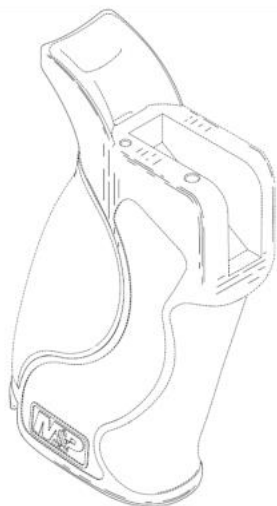

[11] 2016173.7M003

[15] 20-05-2020

[30] 09-01-2020 / US / 29/720,064

[51] Cl. 22-01

[54] 槍支的把手

Hand grip for gun

[73] SMITH & WESSON INC.

2100 Roosevelt Avenue,
Springfield, MA 01104,
United States

[74] CHINA PATENT AGENT (HONG KONG) LIMITED

22/F, Great Eagle Centre,
23 Harbour Road,
Wanchai. Hong Kong

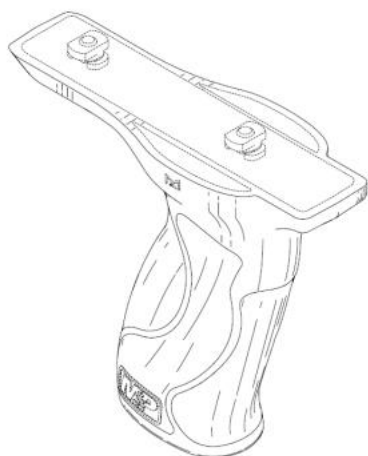

[11] 2016173.7M004

[15] 20-05-2020

[30] 09-01-2020 / US / 29/720,064

[51] C1. 22-01

[54] 槍支的把手

Hand grip for gun

[73] SMITH & WESSON INC.

2100 Roosevelt Avenue,

Springfield, MA 01104,

United States

[74] CHINA PATENT AGENT (HONG KONG) LIMITED

22/F, Great Eagle Centre,

23 Harbour Road,

Wanchai. Hong Kong



[11] 2016277.8

[15] 04-06-2020

[30] 05-12-2019 / FR / 2019-5339

[51] Cl. 3-01

[54] 袋

Bag

[73] LOUIS VUITTON MALLETIER

2 rue du Pont-Neuf,

75001 Paris,

France

[74] BAKER & MCKENZIE

14th Floor, One Taikoo Place,

979 King's Road,

Quarry Bay, Hong Kong



[11] 2016343.8M001

[15] 17-06-2020

[30] 23-12-2019 / US / 29/718,332

[51] Cl. 14-01

[54] 音響耳筒

Audio headset

[73] Bose Corporation

The Mountain, MS 3B1,

Framingham, Massachusetts 01701-9168,

United States

[74] WENPING PATENT & TRADE MARK AGENT LIMITED

1701 Tung Wai Commercial Building,

111 Gloucester Road,

Hong Kong

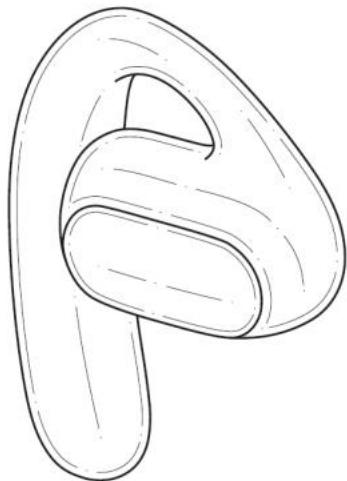

[11] 2016343.8M002

[15] 17-06-2020

[30] 23-12-2019 / US / 29/718,338

[51] Cl. 14-01

[54] 音響耳筒

Audio headset

[73] Bose Corporation

The Mountain, MS 3B1,

Framingham, Massachusetts 01701-9168,

United States

[74] WENPING PATENT & TRADE MARK AGENT LIMITED

1701 Tung Wai Commercial Building,

111 Gloucester Road,

Hong Kong

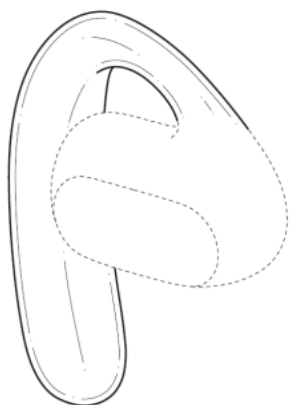

[11] 2016345.3M001

[15] 17-06-2020

[30] 20-12-2019 / US / 29/718,146

[51] Cl. 14-01

[54] 音響眼鏡

Audio eyeglasses

[73] Bose Corporation

The Mountain, MS 3B1,

Framingham, Massachusetts 01701-9168,

United States

[74] WENPING PATENT & TRADE MARK AGENT LIMITED

1701 Tung Wai Commercial Building,

111 Gloucester Road,

Hong Kong



[11] 2016345.3M002

[15] 17-06-2020

[30] 20-12-2019 / US / 29/718,148

[51] Cl. 14-01

[54] 音響眼鏡

Audio eyeglasses

[73] Bose Corporation

The Mountain, MS 3B1,

Framingham, Massachusetts 01701-9168,

United States

[74] WENPING PATENT & TRADE MARK AGENT LIMITED

1701 Tung Wai Commercial Building,

111 Gloucester Road,

Hong Kong

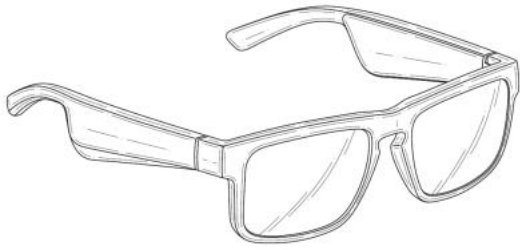

-
- [11] 2016345.3M003
[15] 17-06-2020
[30] 20-12-2019 / US / 29/718,153
[51] Cl. 14-01
[54] 音響眼鏡
Audio eyeglasses
[73] Bose Corporation
The Mountain, MS 3B1,
Framingham, Massachusetts 01701-9168,
United States
[74] WENPING PATENT & TRADE MARK AGENT LIMITED
1701 Tung Wai Commercial Building,
111 Gloucester Road,
Hong Kong

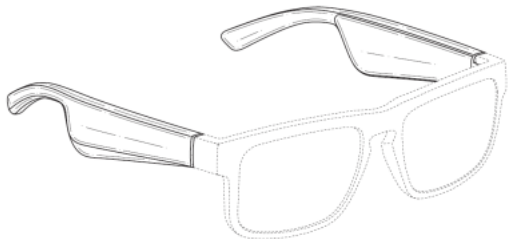

-
- [11] 2016360.4
[15] 18-06-2020
[30] 19-12-2019 / CA, HR, RS, SG, CH, TR, GB, EU, JP, KR /
WIPO90498
[51] Cl. 12-08
[54] 汽車
Car
[73] MASERATI S.P.A.
Viale Ciro Menotti 322,
I-41121 Modena,
Italy

- [74] BIRD & BIRD
6/F, The Annex, Central Plaza,
18 Harbour Road,
Hong Kong

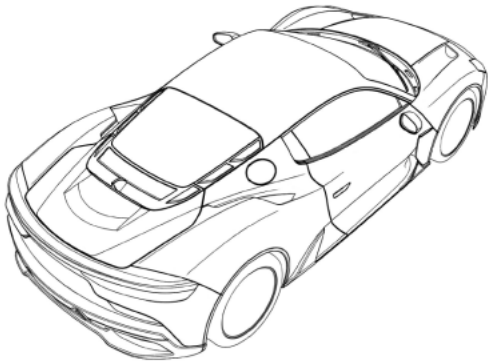

-
- [11] 2016361.6
[15] 18-06-2020
[30] 19-12-2019 / CA, HR, RS, SG, CH, TR, GB, EU, JP, KR /
WIPO90509
[51] Cl. 21-01
[54] 比例汽車模型
Scale car model
[73] MASERATI S.P.A.
Viale Ciro Menotti 322,
I-41121 Modena,
Italy
[74] BIRD & BIRD
6/F, The Annex, Central Plaza,
18 Harbour Road,
Hong Kong

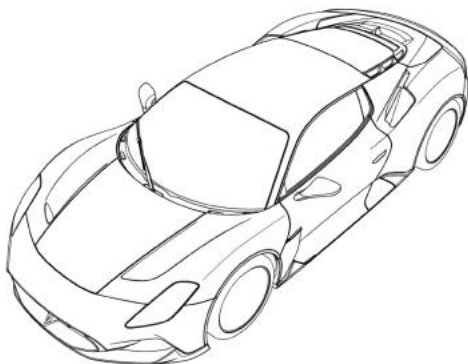

[11] 2016402.4

[15] 24-06-2020

[30] 21-01-2020 / NO, SG, CH, EU, JP, KR / WIPO91351

[51] Cl. 7-01

[54] 壺

Jug

[73] Pi-Design AG

Kantonsstrasse 100,

CH-6234 Triengen,

Switzerland

[74] WENPING PATENT & TRADE MARK AGENT LIMITED

1701 Tung Wai Commercial Building,

111 Gloucester Road,

Hong Kong



[11] 2016413.7M001

[15] 30-06-2020

[30] 30-12-2019 / EU / 007464110

[51] Cl. 6-04

[54] 車型家俱件

Car-shaped furniture element

[73] FERRARI S.p.A.

Via Emilia Est 1163,

I-41100 Modena,

Italy

[74] CHINA PATENT AGENT (HONG KONG) LIMITED

22/F, Great Eagle Centre,

23 Harbour Road,

Wanchai, Hong Kong



[11] 2016413.7M002

[15] 30-06-2020

[30] 30-12-2019 / EU / 007464110

[51] Cl. 6-04

[54] 車型家俱件

Car-shaped furniture element

[73] FERRARI S.p.A.

Via Emilia Est 1163,

I-41100 Modena,

Italy

[74] CHINA PATENT AGENT (HONG KONG) LIMITED

22/F, Great Eagle Centre,

23 Harbour Road,

Wanchai, Hong Kong

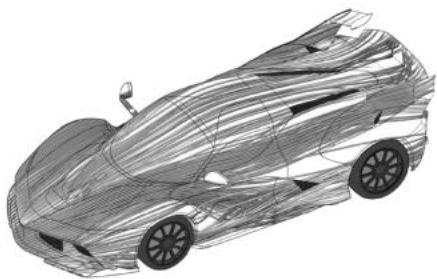

[11] 2016415.2M001

[15] 30-06-2020

[30] 30-12-2019 / EU / 007461595

[51] Cl. 12-08

[54] 汽車

Car

[73] FERRARI S.p.A.

Via Emilia Est 1163,

I-41100 Modena,

Italy

[74] CHINA PATENT AGENT (HONG KONG) LIMITED

22/F, Great Eagle Centre,

23 Harbour Road,

Wanchai, Hong Kong

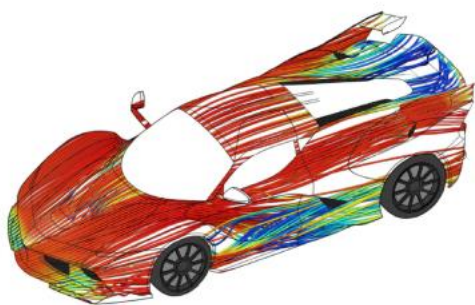

[11] 2016415.2M002

[15] 30-06-2020

[30] 30-12-2019 / EU / 007461595

[51] Cl. 12-08

[54] 汽車

Car

[73] FERRARI S.p.A.

Via Emilia Est 1163,

I-41100 Modena,
Italy

[74] CHINA PATENT AGENT (HONG KONG) LIMITED
22/F, Great Eagle Centre,
23 Harbour Road,
Wanchai, Hong Kong

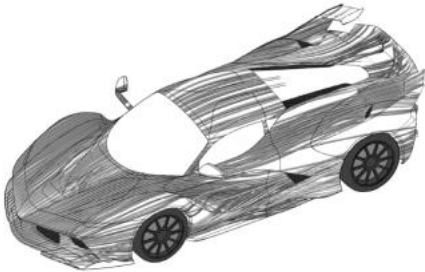

[11] 2016532.0M001

[15] 20-07-2020

[30] 19-01-2020 / CN / 202030036403.8

[51] Cl. 14-04

[54] 具有圖形化使用者介面的機車儀表板
Motorcycle dashboard having graphical user interface

[73] 鯊港科技(上海)有限公司
Sharkharbor Technology (Shanghai) Co., Ltd.
中國內地
上海市閔行區宜山路 1698 號
興迪商務大廈 503 室

[74] 智雅知識產權代理公司
香港荃灣
青山道 264-298 號
南豐中心 1905 室



[11] 2016532.0M002

[15] 20-07-2020

[30] 19-01-2020 / CN / 202030036403.8

[51] Cl. 14-04

[54] 具有圖形化使用者介面的機車儀表板
Motorcycle dashboard having graphical user interface

[73] 鯊港科技（上海）有限公司
Sharkharbor Technology (Shanghai) Co., Ltd.
中國內地
上海市閔行區宜山路 1698 號
興迪商務大廈 503 室

[74] 智雅知識產權代理公司
香港荃灣
青山道 264-298 號
南豐中心 1905 室



[11] 2016532.0M003

[15] 20-07-2020

[30] 19-01-2020 / CN / 202030036403.8

[51] C1. 14-04

[54] 具有圖形化使用者介面的機車儀表板
Motorcycle dashboard having graphical user interface

[73] 鯊港科技（上海）有限公司
Sharkharbor Technology (Shanghai) Co., Ltd.
中國內地
上海市閔行區宜山路 1698 號
興迪商務大廈 503 室

[74] 智雅知識產權代理公司
香港荃灣
青山道 264-298 號
南豐中心 1905 室



- [11] 2016532.0M004
[15] 20-07-2020
[30] 19-01-2020 / CN / 202030036403.8
[51] Cl. 14-04
[54] 具有圖形化使用者介面的機車儀表板
Motorcycle dashboard having graphical user interface
[73] 鯊港科技(上海)有限公司
Sharkharbor Technology (Shanghai) Co., Ltd.
中國內地
上海市閔行區宜山路 1698 號
興迪商務大廈 503 室
[74] 智雅知識產權代理公司
香港荃灣
青山道 264-298 號
南豐中心 1905 室



-
- [11] 2016532.0M005
[15] 20-07-2020
[30] 19-01-2020 / CN / 202030036403.8
[51] Cl. 14-04
[54] 具有圖形化使用者介面的機車儀表板
Motorcycle dashboard having graphical user interface
[73] 鯊港科技(上海)有限公司
Sharkharbor Technology (Shanghai) Co., Ltd.
中國內地
上海市閔行區宜山路 1698 號
興迪商務大廈 503 室
[74] 智雅知識產權代理公司
香港荃灣
青山道 264-298 號
南豐中心 1905 室

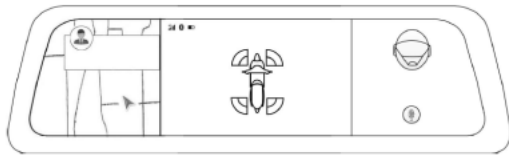

[11] 2016532.0M006

[15] 20-07-2020

[30] 19-01-2020 / CN / 202030036403.8

[51] Cl. 14-04

[54] 具有圖形化使用者介面的機車儀表板

Motorcycle dashboard having graphical user interface

[73] 鯊港科技(上海)有限公司

Sharkharbor Technology (Shanghai) Co., Ltd.

中國內地

上海市閔行區宜山路 1698 號

興迪商務大廈 503 室

[74] 智雅知識產權代理公司

香港荃灣

青山道 264-298 號

南豐中心 1905 室



[11] 2016532.0M007

[15] 20-07-2020

[30] 19-01-2020 / CN / 202030036403.8

[51] Cl. 14-04

[54] 具有圖形化使用者介面的機車儀表板

Motorcycle dashboard having graphical user interface

[73] 鯊港科技(上海)有限公司

Sharkharbor Technology (Shanghai) Co., Ltd.

中國內地

上海市閔行區宜山路 1698 號
興迪商務大廈 503 室

- [74] 智雅知識產權代理公司
香港荃灣
青山道 264-298 號
南豐中心 1905 室

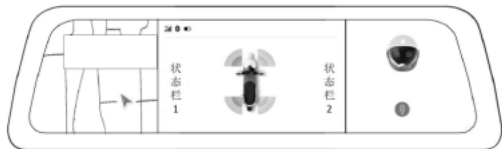

[11] 2016532.0M008

[15] 20-07-2020

[30] 19-01-2020 / CN / 202030036403.8

[51] Cl. 14-04

[54] 具有圖形化使用者介面的機車儀表板
Motorcycle dashboard having graphical user interface

[73] 鯊港科技（上海）有限公司
Sharkharbor Technology (Shanghai) Co., Ltd.
中國內地
上海市閔行區宜山路 1698 號
興迪商務大廈 503 室

- [74] 智雅知識產權代理公司
香港荃灣
青山道 264-298 號
南豐中心 1905 室



[11] 2016534.4

[15] 20-07-2020

[30] 24-02-2020 / DE / 40 2020 100 179.1

[51] Cl. 21-01

[54] 玩具車

Toy vehicle

[73] VOLKSWAGEN AKTIENGESELLSCHAFT

Berliner Ring 2,

38440 Wolfsburg,

Germany

[74] CHINA PATENT AGENT (HONG KONG) LIMITED

22/F, Great Eagle Centre,

23 Harbour Road,

Wanchai, Hong Kong



[11] 2016535.7

[15] 20-07-2020

[51] Cl. 6-01

[54] 椅背

Seat back

[73] 點綴控股有限公司

The Dot Holdings Limited

Flat F, 3/F., The Jade Plaza,

513-531 Canton Road,

Kowloon, Hong Kong

[74] ACCOLADE IP LIMITED

10/F, Fu Fai Comm. Ctr.,

27 Hillier Street,

Sheung Wan, Hong Kong

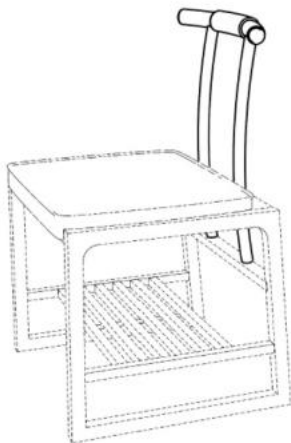

[11] 2016536.9

[15] 20-07-2020

[51] Cl. 6-07

[54] 帶相片框的裝飾物

Ornament with photo frame

[73] Artistic & Creative (H.K.) Limited

6/F, Champion Building,
287-291 Des Voeux Road Central,
Hong Kong

[74] CHAN, TANG & KWOK

Rooms 2503-04, 25/F.,
Shanghai Industrial Investment Building,
48-62 Hennessy Road,
Wanchai, Hong Kong



[11] 2016537.1

[15] 20-07-2020

[51] Cl. 6-07

[54] 帶相片框的裝飾物

Ornament with photo frame

[73] Artistic & Creative (H.K.) Limited

6/F, Champion Building,

287-291 Des Voeux Road Central,

Hong Kong

[74] CHAN, TANG & KWOK

Rooms 2503-04, 25/F.,

Shanghai Industrial Investment Building,

48-62 Hennessy Road,

Wanchai, Hong Kong



[11] 2016538.3

[15] 20-07-2020

[51] Cl. 6-07

[54] 帶底座相框

Photo frame with base

[73] Artistic & Creative (H.K.) Limited

6/F, Champion Building,

287-291 Des Voeux Road Central,

Hong Kong

[74] CHAN, TANG & KWOK

Rooms 2503-04, 25/F.,

Shanghai Industrial Investment Building,

48-62 Hennessy Road,

Wanchai, Hong Kong



[11] 2016539.5

[15] 20-07-2020

[51] Cl. 6-07

[54] 相框

Photo frame

[73] Artistic & Creative (H.K.) Limited

6/F, Champion Building,

287-291 Des Voeux Road Central,

Hong Kong

[74] CHAN, TANG & KWOK

Rooms 2503-04, 25/F.,

Shanghai Industrial Investment Building,

48-62 Hennessy Road,

Wanchai, Hong Kong



[11] 2016540.7M001

[15] 20-07-2020

- [51] Cl. 19-01
- Cl. 19-03
- Cl. 19-04
- Cl. 19-08

[54] 印刷品
Printed matter

[73] BESTIME INTERNATIONAL TRADING LIMITED
Flat 1, 22/F Assun Pacific Centre,
No. 41 Tsun Yip Street,
Kwun Tong, Kowloon, Hong Kong

[74] IPMS CONSULTANTS LIMITED
Unit 2004B, 20/F, Tower 5, China Hong Kong City,
33 Canton Road, Tsim Sha Tsui,
Kowloon, Hong Kong



[11] 2016540.7M002

[15] 20-07-2020

- [51] Cl. 19-01
- Cl. 19-03
- Cl. 19-04
- Cl. 19-08

[54] 印刷品
Printed matter

[73] BESTIME INTERNATIONAL TRADING LIMITED
Flat 1, 22/F Assun Pacific Centre,
No. 41 Tsun Yip Street,
Kwun Tong, Kowloon, Hong Kong

[74] IPMS CONSULTANTS LIMITED
Unit 2004B, 20/F, Tower 5, China Hong Kong City,
33 Canton Road, Tsim Sha Tsui,
Kowloon, Hong Kong



19-20

[11] 2016540.7M003

[15] 20-07-2020

[51] Cl. 19-01
Cl. 19-03
Cl. 19-04
Cl. 19-08

[54] 印刷品
Printed matter

[73] BESTIME INTERNATIONAL TRADING LIMITED
Flat 1, 22/F Assun Pacific Centre,
No. 41 Tsun Yip Street,
Kwun Tong, Kowloon, Hong Kong

[74] IPMS CONSULTANTS LIMITED
Unit 2004B, 20/F, Tower 5, China Hong Kong City,
33 Canton Road, Tsim Sha Tsui,
Kowloon, Hong Kong



[11] 2016540.7M004

[15] 20-07-2020

[51] Cl. 19-01

Cl. 19-03

Cl. 19-04

Cl. 19-08

[54] 印刷品

Printed matter

[73] BESTIME INTERNATIONAL TRADING LIMITED

Flat 1, 22/F Assun Pacific Centre,

No. 41 Tsun Yip Street,

Kwun Tong, Kowloon, Hong Kong

[74] IPMS CONSULTANTS LIMITED

Unit 2004B, 20/F, Tower 5, China Hong Kong City,

33 Canton Road, Tsim Sha Tsui,

Kowloon, Hong Kong



19-20

[11] 2016540.7M005

[15] 20-07-2020

[51] Cl. 19-01

Cl. 19-03

Cl. 19-04

Cl. 19-08

[54] 印刷品

Printed matter

[73] BESTIME INTERNATIONAL TRADING LIMITED

Flat 1, 22/F Assun Pacific Centre,

No. 41 Tsun Yip Street,

Kwun Tong, Kowloon, Hong Kong

- [74] IPMS CONSULTANTS LIMITED
Unit 2004B, 20/F, Tower 5, China Hong Kong City,
33 Canton Road, Tsim Sha Tsui,
Kowloon, Hong Kong



-
- [11] 2016541.9
[15] 20-07-2020
[51] Cl. 9-03
[54] 包裝盒
Packaging box
[73] 卡萊美化妝品有限公司
Colourmix Cosmetics Company Limited
10th Floor, Wyler Centre Phase II,
192-200 Tai Lin Pai Road,
Kwai Chung, New Territories,
Hong Kong
[74] MARKPAL IP LIMITED
Unit A, 11/F Amtel Building,
144-148 Des Voeux Road Central,
Hong Kong



[11] 2016542.1

[15] 21-07-2020

[30] 18-03-2020 / MA, NO, OM, SG, CH, TN, TR, UA, GB, EU, AL /
DM/207 353

[51] Cl. 10-02

[54] 手錶

Wristwatch

[73] SWATCH AG (SWATCH SA) (SWATCH LTD.)

Nicolas G. Hayek Strasse 1,
2502 Biel/Bienne,
Switzerland

[74] SPRUSON & FERGUSON (HONG KONG) LIMITED

5001 Hopewell Centre,
183 Queen's Road East,
Wan Chai, Hong Kong



[11] 2016543.3

[15] 21-07-2020

[30] 02-07-2020 / MA, NO, OM, SG, CH, TN, TR, UA, GB, EU, AL /
DM/209 123

[51] Cl. 10-02

[54] 手錶

Wristwatch

[73] SWATCH AG (SWATCH SA) (SWATCH LTD.)

Nicolas G. Hayek Strasse 1,
2502 Biel/Bienne,
Switzerland

[74] SPRUSON & FERGUSON (HONG KONG) LIMITED

5001 Hopewell Centre,
183 Queen's Road East,
Wan Chai, Hong Kong



[11] 2016545.8

[15] 21-07-2020

[51] Cl. 13-02

[54] 儲能移動電源

Energy storage power bank

[73] 深圳派立通科技有限公司

Shenzhen Pilot technology Co.,LTD
中國內地

廣東省深圳市龍崗區平湖街道山廈社區杉坑路 7 號 A1 廠房 101 (A1 工業園)

[74] 中港專利有限公司

香港

港灣道 1 號會展廣場

辦公大樓 30 樓 3012 室



[11] 2016546.0

[15] 22-07-2020

[30] 05-03-2020 / JP / 004364 of 2020

[51] Cl. 24-02

[54] 安全櫃
Safety cabinet

[73] Rohto Pharmaceutical Co., Ltd.
8-1, Tatsumi-nishi 1-chome,
Ikuno-ku, Osaka-shi,
Osaka 544-8666,
Japan

[74] DEACONS
5th Floor, Alexandra House,
Central,
Hong Kong

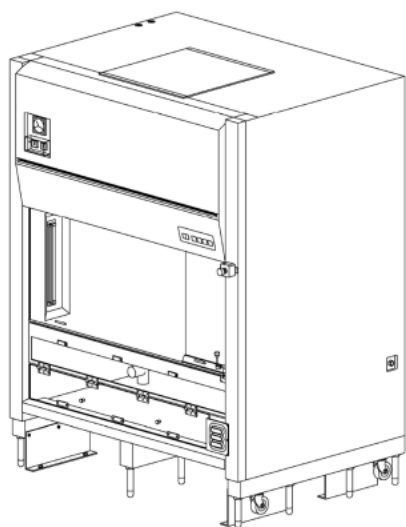

[11] 2016551.0M001

[15] 22-07-2020

[30] 24-06-2020 / US / 29/739,316

[51] Cl. 8-08

[54] 手提電話吊架

Cell phone hanger

[73] MARK EDGSON

1656 Quinn Street S.,
Prince George V2N 1X3,
British Columbia,
Canada

[74] WENPING PATENT & TRADE MARK AGENT LIMITED

1701 Tung Wai Commercial Building,
111 Gloucester Road,
Hong Kong

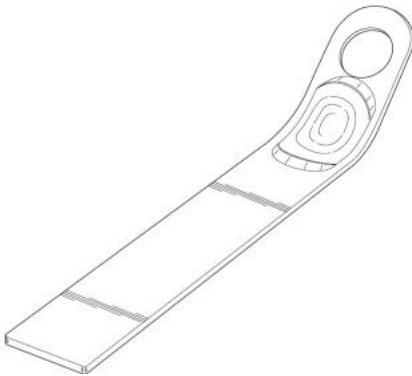

[11] 2016551.0M002

[15] 22-07-2020

[30] 23-01-2020 / US / 29/721,779

[51] Cl. 8-08

[54] 手提電話吊架

Cell phone hanger

[73] MARK EDGSON

1656 Quinn Street S.,
Prince George V2N 1X3,
British Columbia,
Canada

[74] WENPING PATENT & TRADE MARK AGENT LIMITED

1701 Tung Wai Commercial Building,
111 Gloucester Road,
Hong Kong

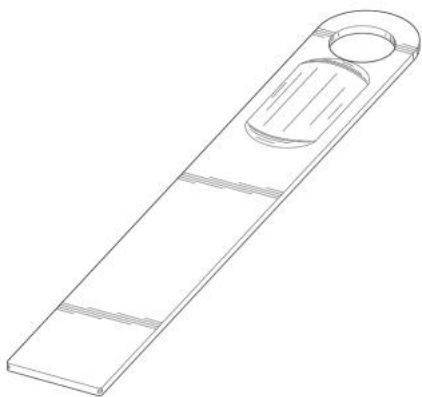

[11] 2016553.4M001

[15] 23-07-2020

[51] Cl. 11-01

[54] 首飾

Jewellery

[73] TASAKI & Co., Ltd.

3-2, 6-chome, Minatojima Naka-machi,

Chuo-ku, Kobe 650-0046,

Japan

[74] DEACONS

5th Floor, Alexandra House,

Central,

Hong Kong

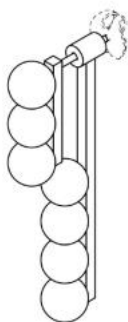

[11] 2016553.4M002

[15] 23-07-2020

[51] Cl. 11-01

[54] 首飾

Jewellery

[73] TASAKI & Co., Ltd.

3-2, 6-chome, Minatojima Naka-machi,
Chuo-ku, Kobe 650-0046,
Japan

[74] DEACONS

5th Floor, Alexandra House,
Central,
Hong Kong

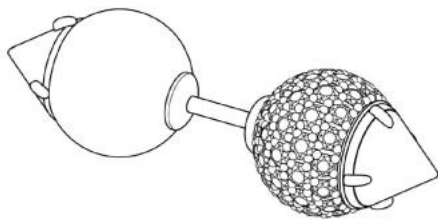

[11] 2016553.4M003

[15] 23-07-2020

[51] Cl. 11-01

[54] 首飾

Jewellery

[73] TASAKI & Co., Ltd.

3-2, 6-chome, Minatojima Naka-machi,
Chuo-ku, Kobe 650-0046,
Japan

[74] DEACONS

5th Floor, Alexandra House,
Central,
Hong Kong

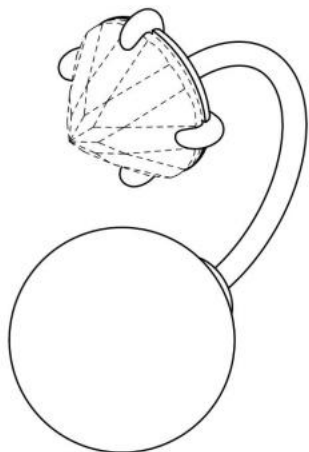

[11] 2016553.4M004

[15] 23-07-2020

[51] Cl. 11-01

[54] 首飾

Jewellery

[73] TASAKI & Co., Ltd.

3-2, 6-chome, Minatojima Naka-machi,

Chuo-ku, Kobe 650-0046,

Japan

[74] DEACONS

5th Floor, Alexandra House,

Central,

Hong Kong

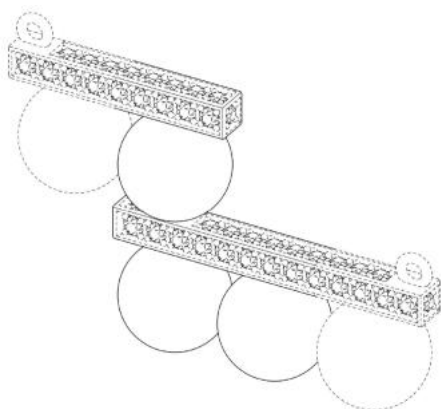

[11] 2016553.4M005

[15] 23-07-2020

[51] Cl. 11-01

[54] 首飾
Jewellery

[73] TASAKI & Co., Ltd.
3-2, 6-chome, Minatojima Naka-machi,
Chuo-ku, Kobe 650-0046,
Japan

[74] DEACONS
5th Floor, Alexandra House,
Central,
Hong Kong

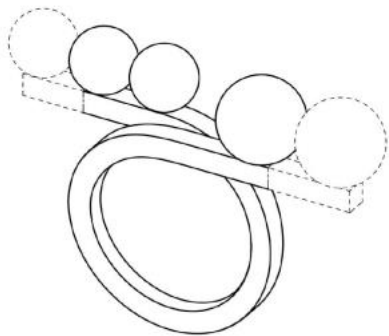

[11] 2016553.4M006

[15] 23-07-2020

[51] Cl. 11-01

[54] 首飾
Jewellery

[73] TASAKI & Co., Ltd.
3-2, 6-chome, Minatojima Naka-machi,
Chuo-ku, Kobe 650-0046,
Japan

[74] DEACONS
5th Floor, Alexandra House,
Central,
Hong Kong

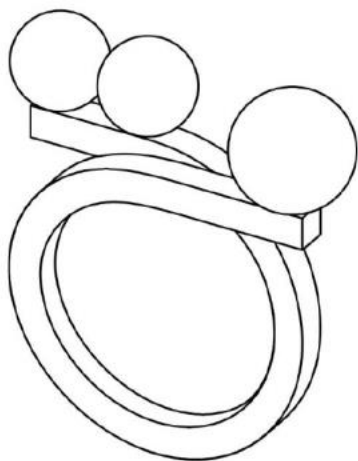

[11] 2016555.9

[15] 23-07-2020

[51] C1. 14-01

[54] 正方形壁掛式音箱

Square shaped wall mounted speaker

[73] 數碼綠洲有限公司

DIGITAL OASIS LIMITED

香港黃竹坑

業興街 11 號

南匯廣場 B 座 6 樓 618 室

[74] 香港銘煥知識產權有限公司

香港九龍灣

宏開道 16 號

德福大廈 13 樓 12 室

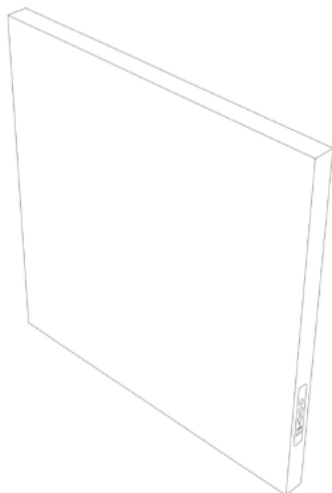



香港特別行政區政府知識產權署外觀設計註冊處

The Government of the Hong Kong Special Administrative Region

Designs Registry, Intellectual Property Department

根據註冊外觀設計條例第 28 條，下列註冊外觀設計因未繳續期費而停止有效。

各組記項按註冊外觀設計停止有效日期及註冊編號先後次序排列。

Registered designs ceased through non-payment of renewal fees under section 28 of the Registered Designs Ordinance. Entries are listed below under their expiry dates.

20-08-2020 - 25-08-2020**20-08-2020**

1501850.0M001

1501850.0M002

1501850.0M003

1501850.0M004

1501850.0M005

1501852.4

1501853.6

1501854.8

1501865.2M002

1501870.2

1501871.4

25-08-2020

1001553.5

1501874.0

1501875.3M001

1501875.3M002

1501875.3M003

1501875.3M004

1501878.9M001

1501878.9M002

21-08-2020

0011122.1

22-08-2020

1001531.9

1001532.1

23-08-2020

1501855.1

1501861.3

24-08-2020

0501971.4

0501976.5M001

1001544.6

1001545.9

1001548.5M001

1001548.5M002

1001548.5M003

1001549.7M001

1001549.7M002

1001549.7M003

1501864.9

1501865.2M001



香港特別行政區政府知識產權署外觀設計註冊處

The Government of the Hong Kong Special Administrative Region

Designs Registry, Intellectual Property Department

根據註冊外觀設計規則第 31 條刪除的註冊外觀設計。各組記項按註冊外觀設計刪除日期及註冊編號先後次序排列。

Registered designs removed under section 31 of the Registered Designs Rules. Entries are listed below under their removal dates.

10-10-2020 - 14-10-2020

10-10-2020	1000351.5
1000312.3M001	1000352.7
1000312.3M002	1000354.1
	1500500.8
11-10-2020	1500501.0
1000313.5	1500503.4M001
1000314.7	1500503.4M002
1500485.4	1500504.6
	1500505.9
12-10-2020	1500509.7
0010216.0	1500510.9
0010223.4	1500511.1
0500366.0M001	1500512.3
0500366.0M002	1500513.5
0500366.0M003	1500514.7
1000328.7	1500515.0
1500489.2	1500516.2
1500490.4	1500517.4
1500491.6	
1500492.8	
1500493.0	
1500494.2	

13-10-2020

1000334.9M002
1500496.7M001
1500496.7M002
1500498.1

14-10-2020

1000339.0M001
1000339.0M002
1000339.0M003
1000350.3



香港特別行政區政府知識產權署外觀設計註冊處
The Government of the Hong Kong Special Administrative Region
Designs Registry, Intellectual Property Department

勘誤

CORRIGENDUM

已在官方公報刊登的外觀設計公告內的註冊擁有人姓名更正如下:

The following show the corrected registered owner's name in advertisement previously published in the official journal:

官方公報日期 Official journal date 30.09.2020

[11] 2016412.5M001

[73] 《葉宣恒》以《猿創(香港)有限公司》之名營業

[11] 2016412.5M002

[73] 《葉宣恒》以《猿創(香港)有限公司》之名營業